

Cutting Tools

2022-23



Aerospace Industry



Automotive Industry



Shipbuilding Industry



Railway Industry

Index



Grades & Chip Breakers



Turning



Multi Functional Tools



Threading



Milling



Drill



Tooling System



Parts



Technical Information

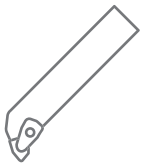


Old-Fashioned
Product Information



Index

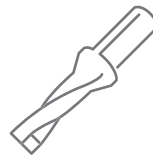
2022-2023 KORLOY CUTTING TOOLS



Turning



Milling



Holemaking



Endmilling

CONTENTS

GRADES & CHIP BREAKERS

A Grades

A02 KORLOY grades system

Turning Grades

A04 Turning grade selections

A05 CVD coated grades

A10 PVD coated grades

A12 Uncoated Carbide grades

A13 Cermet grades

A15 Coated Cermet grades

Milling Grades

A16 Milling grade selections

A17 CVD coated grades

A18 PVD coated grades

A23 Uncoated Carbide grades

A24 Cermet grades

A Solid Endmills & Solid Drills

A25 Solid Endmills grade selections

A26 Solid Endmills grades

A27 Solid Drills grade selections

A28 Solid Drills grades

Others (Turning/Milling/Endmills)

A29 Diamond coated grades

A30 DLC coated grades

A31 cBN inserts grades

A36 PCD inserts grades

Chip Breakers

A37 Chip Breaker for Turning

A42 Chip Breaker for Milling

A49 Chip Breaker for Drilling

TURNING

B Turning Chip Breakers

B02 Application range of KORLOY main Chip Breakers

B04 Recommended Chip Breakers for workpiece

B16 Feature of Chip Breakers

Inserts

B34 Turning Insert Code System (ISO)

B36 Turning Insert (Negative)

B73 Turning Insert (Positive)

B102 Aluminum Insert (Positive)

B110 cBN Inserts

B113 PCD Inserts

Save Turn

B114 Technical Information for Save Turn

B115 Save Turn (Insert)

B116 Save Turn (Holder)

B119 Save Turn (Boring Bar)

Auto Tools

B121 Technical Information for Auto tools

B122 ISO type

B127 KHP Coolant

B136 Blade type

B139 Multi Utility type

B142 KGT/MGT type

B145 MSB Tool

B151 Sleeve

Multi Turn

B152 Technical Information for Multi Turn

B154 Multi Turn

B Bearing Solutions

B155 Technical Information for Bearing Solutions

B156 Bearing Solutions

B161 Special Order Form for Bearing Inserts

External Tool Holder

B162 External tool Holder Code System (ISO)

B163 Index for External Holder

B166 Instruction of External Holder assembly

B167 Double Clamp System

B172 Lever Lock System

B179 Wedge Clamp System

B181 Clamp on System

B183 Multi Lock System

B190 Screw on System

B197 Ceramic Holder

High Pressure Coolant

B199 Technical Information for KHP Coolant

B202 KHP Coolant

Boring Bar

B204 Boring Bar Code System (ISO)

B205 Index for Boring Bar

B207 Instructions of Boring Bar assembly

B208 Double Clamp System

B210 Lever Lock System

B212 Clamp on System

B213 Multi Lock System

B215 Screw on System

B225 Compact Mini

TURNING

B HSK/KM Tooling system

- B228** Technical Information for HSK/KM Tooling System
- B230** Index for HSK/KM Tooling System
- B231** HSK Tooling system
- B237** KM Tooling system

B Cartridges

- B241** Cartridge Code System (ISO)
- B242** Index for Cartridge
- B243** Clamp on System
- B245** Screw on System

MULTI FUNCTIONAL TOOLS

C Application Example

- C02** Application Example
- C04** Technical Information for Multi Functional tools

C K Notch

- C55** Technical Information for K Notch
- C57** K Notch

KGT

- C07** Technical Information for KGT
- C12** KGT
- C25** KGT Blade for Parting off

Saw Man

- C60** Technical Information for Saw Man
- C61** Saw Man

MGT

- C26** Technical Information for MGT
- C28** MGT
- C36** MGT (Face grooving)

Saw Man-X

- C63** Technical Information for Saw Man-X
- C65** Saw Man-X

KGT/MGT Cartridge

- C39** Technical Information for KGT/MGT Cartridge
- C40** KGT/MGT Cartridge Holder
- C41** KGT Cartridge
- C42** MGT Cartridge

Fine Tools

- C67** Technical Information for Fine Tools
- C68** Fine Tools

MGT Aluminum Wheel Series

- C43** Technical Information for MGT Aluminum Wheel
- C44** MGT Aluminum Wheel

Grooving/Parting off

- C70** IGH
- C70** DBH
- C71** GFIP

TB/TB-M

- C47** Technical Information for TB/TB-M
- C51** TB/TB-M

Special Order Form

- C72** Special Order Form for MGT
- C73** Special Order Form for V-Pulley Insert

THREADING

D Threading Code System

- D02** Threading Holder/Insert Code System

Technical Information for Threading

- D03** Technical Information for Threading
- D09** Threading Insert with Chip Breaker

D Thread Inserts

Thread Inserts

- D10** Partial profile 60°
- D11** Partial profile 55°
- D12** ISO Metric

- D16** American UN (UN, UNC, UNF, UNEF, UNS)
- D18** Whitworth (BSW, BSF, BSP, BSB)
- D22** British Standard Pipe Thread (BSPT)
- D22** National Pipe Thread (NPT)
- D23** National Pipe Threads-Dryseal (NPTF)
- D23** Round DIN405 (RD)
- D24** Trapez DIN103 (TR)
- D24** American ACME (ACME)
- D25** Stub ACME (STACME)

CONTENTS

THREADING

D Thread Inserts

- D26** UNJ (Unified Constant Thread)
- D28** American Buttress (ABUT)
- D28** British Buttress (BBUT)
- D29** Metric Buttress (SAGE)/API
- D30** API Buttress Casing (BUT)
- D30** API Round Casing & Tubing (APIRD)
- D30** Extreme Line Casing (EL)

D Thread Holders

- D31** External Holder
- D32** Internal Holder
- D33** Vertical Type Holder

Thread Milling

- D34** Technical Information for Thread Milling
- D44** Thread Milling Insert
- D49** Thread Milling Holder

MILLING

E Insert

- E02** Milling Insert Code System (ISO)
- E04** Milling Inserts
- E34** KORLOY Cutters
- E42** KORLOY Shanks
- E45** KORLOY Modular Adaptors

Face Milling Cutters

- E47** Mill-max (ISO)/Mill-max Plus (E48, E54)
- E57** Mill-max Heavy
- E59** Turbo Mill
- E62** Double Mill
- E64** Power Buster
- E71** Rich Mill
- E147** Aero Mill/Aero Mill-Plus/Aero Mill-Mini
- E156** PCD face cutter

Cutters for Molds

- E157** Alpha Mill/Alpha Mill Nick
- E193** Alpha Mill-X
- E201** Future Mill/Future Mill P-Positive
- E254** Triple Mill
- E262** HFMD
- E277** HFM
- E284** HRMDouble
- E300** HRM
- E307** Tank Mill
- E308** TP2P
- E317** Laser Mill/GBE/BRE
- E337** HAVE(Multi-edge, Single-edge)
- E341** Technical Information for BT/HSK Tooling System
- E342** BT Tooling System (Alpha Mill, Mono-Tool)
- E353** HSK Tooling System (Alpha Mill, Mono-Tool, Pro-V Mill)
- E364** O-ring Cutter
- E366** Chamfer Tool (Multi-functional, Solid)
- E374** T-Cutter(TFE)

E Milling Cutter for Aluminum

- E375** Technical Information for Pro-A Mill/Pro-X Mill/Pro-L Mill/Pro-XL Mill/Pro-V Mill
- E385** Pro-A Mill
- E388** Pro-X Mill
- E394** Pro-L Mill
- E398** Pro-XL Mill
- E399** Pro-V Mill
- E401** Modular Adaptor (MAT/BT/HSK)

Side Milling Cutters

- E405** Technical Information for Side Milling Cutters
- E407** Side Milling Cutters
- E411** Side Cutter
- E414** Wind Mill

Milling Cutter for Cast iron at high feed

- E418** Technical information for High feed Cutter
- E420** Technical information for Cube Mill
- E421** Technical information for Couple Mill
- E423** Technical information for Shave Mill
- E425** Technical information for Shave Mill Ultra

Detail Information of Milling Cutter and Arbor

- E426** Actual Designation of Milling Cutter and Arbor

Gear Tools

- E429** Technical information for Gear Cutter Tools
- E430** Gear Cutter Table
- E431** Gear Cutter
- E439** Gear Cutter Order Form
- E440** Indexable HOB
- E441** Indexable HOB Cutter Order Form

DRILL

F Technical Information for Drills

- F02** KORLOY Drills
- F03** Available Insert

Indexable Drills

- F05** King Drill
- F20** King Drill (for through coolant system with a lathe)
- F24** King Drill (for large diameter drilling)
- F26** KED Plus Drill
- F37** TPDC Plus Drill

F Indexable Drills

- F54** TPDB Plus Drill
- F63** TPDB-F
- F68** TPDB-H
- F75** Technical information for WPDC
- F78** Center Drill
- F79** WPDC

Reamer

- F82** Indexable Reamer

TOOLING SYSTEM

G Tooling System

- G02** Tooling System Index
- G04** DHE/S
- G07** DHE
- G11** DHC/DHJ Collet
- G12** DSC
- G20** NPM
- G23** DCS/DC/TC
- G24** Collet Chuck Series
- G25** SDC/P
- G30** DSK
- G32** GSK
- G34** GERC
- G36** ER
- G37** ER/L
- G38** RTJW
- G40** NPU
- G41** DST
- G43** TER Tap Collet
- G44** DTN
- G46** TCA Tap Adaptor
- G47** SLA

G Tooling System

- G49** FMA
- G50** FMC
- G52** MD
- G54** EXT Bar
- G54** RDC Bar
- G55** FBH/B
- G62** DBCA
- G66** DBC
- G68** SMB
- G70** KMB
- G72** SMH
- G74** TBCA
- G79** TBC
- G82** FBC
- G85** SAH
- G86** Angular Head
- G94** DZC
- G95** DCJ
- G96** DCL
- G97** DAMPING PRO
- G104** Others

PARTS

H Parts

- H02** Shim
- H03** Cartridge/Chip Breaker
- H03** Chip Cover/Clamp
- H04** Coolant Bolt/Wrench Bolt
- H04** Lever
- H05** Locator/Nut

H Parts

- H05** Pin/Screw
- H06** Shim Pin
- H07** Spring/Wrench
- H07** Stop Ring/Washer
- H07** Stopper/Nozzle

CONTENTS

TECHNICAL INFORMATION

I General Information I

- I 02** Workpiece material grades
- I 06** Steel, Non-ferrous metal symbol list
- I 07** SI unit conversion table
- I 08** Hardness calculating table
- I 09** Properties of Korloy grades

Technical Information

- I 10** Technical Information for Turning
- I 20** Technical Information for Milling

I Technical Information

- I 24** Technical Information for Tapers
- I 27** Technical Information for Endmills
- I 30** Technical Information for Drill

General Information II

- I 36** The comparison of chip breakers
- I 37** KORLOY Grades
- I 40** The comparison of grades for Turning/Milling

OLD-FASHIONED PRODUCT INFORMATION

J Old-fashioned product information

- J02** Grade
- J02** External Holder
- J02** Fine Tool
- J03** Threading Tool

J Old-fashioned product information

- J03** Mill-Max
- J04** Cen-Mill
- J04** Jip Drill
- J04** LPD/SPD/NPD

INDEX

K Index

SAFETY GUIDE OF CARBIDE PRODUCTS

KORLOY Inc. is continuously trying to develop safer and higher quality products
Please be aware of the safety guidelines below prior to using KORLOY Inc. products

- It is generally accepted that the proper handling of cemented carbide tools requires awareness of safety as noted above. For more information, please contact us.
- KORLOY does not accept any responsibility for any accident caused by inappropriate use, abuse of tools, or changes to the products.

1. PL (Product Liability)

In accordance with the PL (Product Liability) law, we have attached a WARNING label on the case of KORLOY products. There is no warning on the surface of the tools. Please read this safety guidelines before using carbide tools and provide safety education to all users.

2. Basic characteristics of CEMENTED CARBIDE tools

Cemented carbide tools are made of carbides, nitrides, carbonitrides, oxides of Tungsten (W), Titanium (Ti), Alluninyum (Al), Silicon (Si), Tantalum (Ta), Boron (B) etc. and metal component like Cobalt (Co), Nickel (Ni), Chrom (Cr), Molybdenum (Mo) as binder. Cemented carbides tools have high hardness and specific gravity. Generally there's no smell but according to usage and treatment, appearance and color could be changed

3. Precaution for CEMENTED CARBIDE tools

- 1) Cemented carbides are extremely hard and brittle at the same time. Impact shock or excessive clamping power could cause fracture or breaking of the tool.
- 2) Cemented carbides have large specific gravity, thus they require special attention as a heavy material when you handle big sizes or large quantities.
- 3) Cemented carbides have different thermal expansion coefficient with steel and ferrous materials. Shrink fit or swell fit products may cause trouble if they are used at undesirable conditions like extremely high or low temperatures.
- 4) There are several cemented carbide products having sharp cutting edges. Be careful not to handle the tools with bare hands which may cause cuts or injury, especially when removing the tools from the case, do not touch the cutting edge and be careful not to drop it.
- 5) Storing carbide tools in a corrosive atmosphere may cause erosion which can reduce toughness.
- 6) Please refer to the catalogue safety guidance prior to handling the tools.
- 7) Do not abuse tools under inappropriate conditions.

4. Precaution for machining (grinding, welding, EDM) of CEMENTED CARBIDE tools

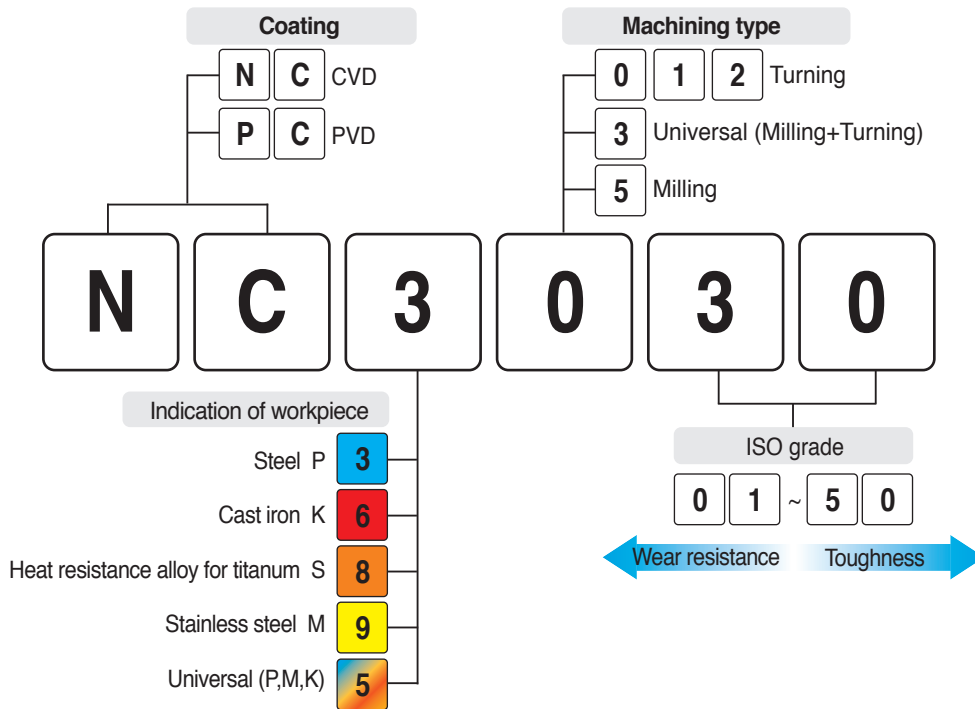
- 1) Surface condition can affect the toughness of the tool, so it is recommended to use a diamond grinding wheel.
- 2) Grinding of cemented carbide creates mist and dust. It contains harmful compositions like Cobalt (Co), thus it is recommended to use a mask, mist collection, and other protective facilities. If the dust gets in your skin or eye, rinse immediately with continuously running water.
- 3) In case of grinding with coolant, coolant contains harmful metal components which cause environmental problems. Handle the coolant according to the manufacturer's recommendations.
- 4) Check for cracks after re-grinding carbide tool and reuse.
- 5) Marking with laser or electric pen may cause cracks on the carbide tool. The crack can shorten tool life.
- 6) EDM of carbide may cause residual cracks on the carbide tool, so if necessary, remove the crack with a grinding process.
- 7) Brazing of carbide tools at extremely high or low temperatures compare with the melting point of brazing materials may cause loosening or breakage.
- 8) Overheating a oil base coolant may cause a fire or flames, thus be prepared for fire prevention.

5. METALCUTTING SAFETY

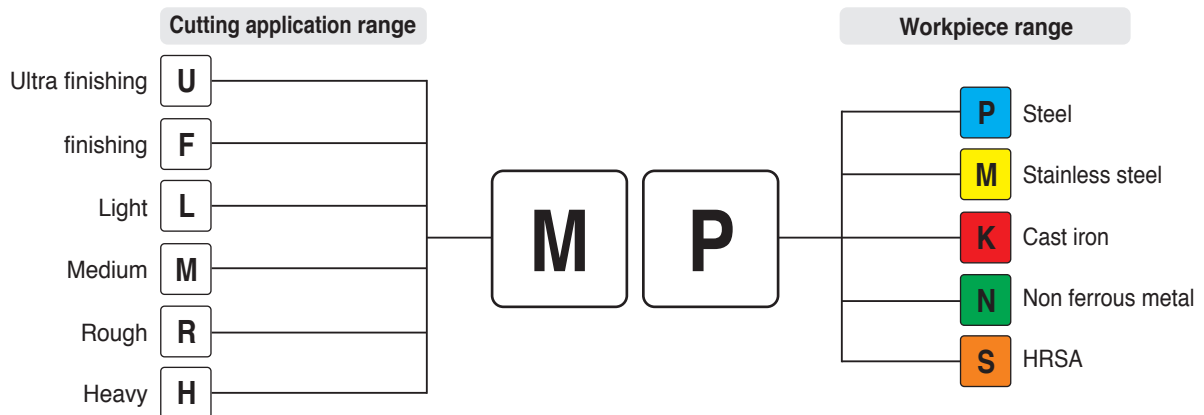
	DANGEROUS FACTOR	SAFETY COUNTERPLAN
Cutting tools	• Sharp cutting edge of cutting tools may cut your bare-hand	• Use gloves when pulling out the insert from the case or mounting it on the machine
	• Inappropriate conditions or usage may cause fragmentation and expel parts of tools which may cause injury	• Use glasses or safety cover for your safety • Use the tools within the recommended range • Please refer to catalogue and safety guidelines first
	• Severe load on tool and premature wear of cutting edge may bring excessive cutting force on tool, causing fracture of the tool and may cause injury	• Use glasses or safety cover for your safety • Change the tool as required before excessive wear or fracture
	• Chips evacuated during cutting are hot and sharp and may cause burns and cuts	• Use glasses or safety cover for your safety • Stop machining and put safety glove on and use a hook tool to remove chips
	• Touching the workpiece immediately after cutting may cause burns	• Use gloves or safety cover for your safety
	• Be aware of sparks, fire, or explosion of hot chips generated during the cutting operation	• Do not use at the place where having explosive materials • Prepare for fire extinguishments
	• In case of high RPM machining, vibration and chattering may occur due to the improper balance of the machine	• Use glasses or safety cover for your safety • Check first if there's any chattering, vibration or strange noises prior to your main cutting operation
	• Touching a burr remaining on the workpiece with a bare-hand may cause a cut	• Do not touch the burr with bare-hand · Use gloves or safety cover for your safety
	• Loose clamping of the workpiece may cause the tool to fracture and result in damage to the cutter body and possible injury	• Clamp the workpiece tightly
Indexable tools	• Tools are operated to right-hand direction normally	• Do not use left-hand direction without notice
	• Left-hand direction operation can cause fracture of tool and body damage	• Check the package of product to check the availability of left-hand operation
	• Loose clamping of inserts and parts may result in ejection of the tool during cutting and may cause serious injury	• Check the clamping of inserts and parts prior to machining, and use original parts only
Rotating tools	• Over loaded clamping of inserts by a lever (such as a pipe) may cause dangerous fracturing of parts and inserts	• Do not use lever inappropriately
	• In case of high speed machining, parts and inserts can be forced out by centrifugal force	• Use within recommended condition · Use glasses or safety cover for your safety
	• Since cutter has sharp cutting edges touching with a bare-hand may cause a cut	• Use gloves or safety cover for your safety
	• It is dangerous to use glove with rotating machine	• Do not wear gloves when you work with rotating machine
	• Contact with body or clothes is dangerous with rotating parts	• Keep your body and clothes away from rotating machine
Brazed tools	• Vibration generated by balancing trouble may cause a fracture and ejection of the tool which may cause serious injury	• RPM should be controlled within recommended condition • Check the balance of rotating part periodically
	• In case of drilling, the uncut bottom core can fly out of the part with high speed and cause serious injury	• Use gloves or safety cover for your safety
	• The edges of small diameter drill are sharp and easy to break	• Concentrate on safety regulation in using tools. • Use glove or safety cover for your safety.
	• Fragmentation and ejection of brazed carbide tip may cause injury	• Check the brazed tip before using • Do not use at high temperature cutting condition
ETC	• There's a possibility of breaking the carbide tip after several brazing	• Do not use brazing a tip that has been brazed several times
	• Abusing may cause fragmentation of tool and is very dangerous	• Stick to safety regulations and guidelines

KORLOY Inc. Code System

Grade name for coated carbide



Chip breaker



The same chip breaker code is used for both negative type and positive type.

Terminology of tool formula

TERM	CODE	UNIT
Tool diameter	D	mm
Cutting speed	vc	m/min
Revolution per minute	n	min ⁻¹
Feed per minute	vf	mm/min
Feed per revolution	fn	mm/rev
Feed per tooth	fz	mm/t
Tooth	z	
Axial depth of cut	ap	mm
Radial depth of cut	ae	mm
Peak feed	pf	mm

TERM	CODE	UNIT
Horse power requirement	Pc	kW
Specific cutting resistance	kc	MPa
Torque	Mc	N.m
Thrust	Tc	N
Cycle time	tc	min
Tool life	T	min
Flank wear	V _B	mm
Crater wear	Kt	mm
Nose radius	r	mm

Introduction of Digital Catalogue

1. Connect to the digital catalogue on PC or mobile

<https://catalog.korloy.com>

Special tooling
For special tooling such as gear, edge miller, railway, non-standard indexable & facemill

2. Guideline for main screen

PC

Grade guide
Explanation of standard grades on the catalogue

My assembly
Vivid assembly

Log in/ registration
E-mail/password

Language
Switch to the selected language

Measurement unit
Metric/inch

Current(Unused)
KRW/USD/EUR

Search items
Search necessary item with its grade or designation

Main application
Select the main application of necessary items.

Mobile

3. Details

Sub application



Item group



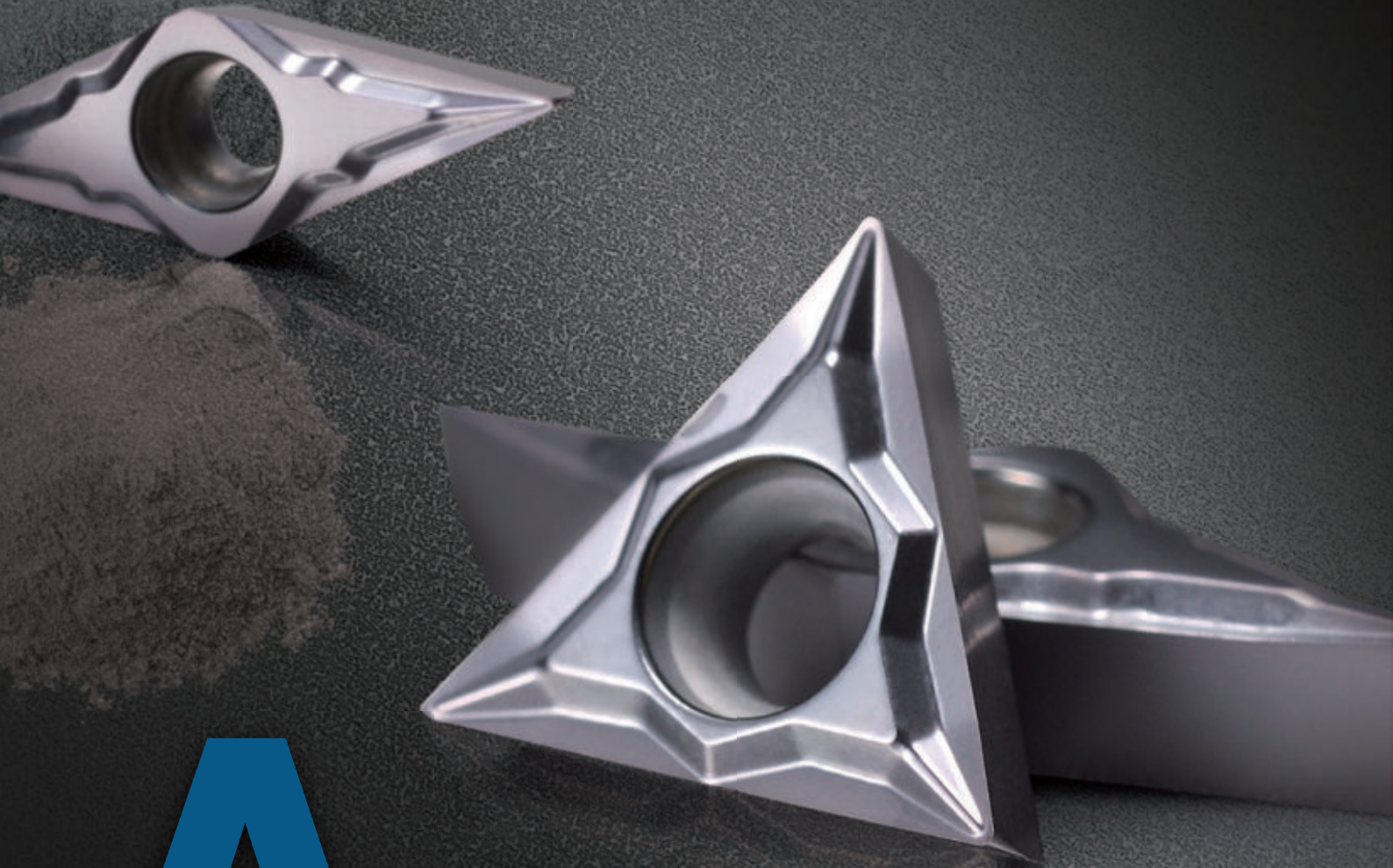
Item

Part	A.P. Code	Designation	DC	BSL	SLT	APRN	DC/BSL/SLT	LT	SHAB	QT	WCD	WCDW
<input type="checkbox"/>	118-00000	RichMill RML118000	18	50.000	0000	0.5	25	40	40	0.20		
<input type="checkbox"/>	118-00000	RichMill RML118000	18	50.000	0000	0.5	25	40	40	0.20		
<input type="checkbox"/>	118-00000	RichMill RML118000	18	75.000	0000	0.5	25	40	40	0.20		

Item data, 2/3D modeling, etc.

GRADES & CHIP BREAKERS

KORLOY's new grades are designed with optimal substrates for each application and are PVD coated for high temperature, high hardness and oxidation resistance, or CVD coated for high temperature and wear resistance. Additionally, the improved post-coating treatment provides superior surface finishes to ensure the highest levels of quality and productivity.



A

Grades

A02 KORLOY grades system

Turning Grades

A04 Turning grade selections
A05 CVD coated grades
A10 PVD coated grades
A12 Uncoated Carbide grades
A13 Cermet grades
A15 Coated Cermet grades

Milling Grades

A16 Milling grade selections
A17 CVD coated grades
A18 PVD coated grades
A23 Uncoated Carbide grades
A24 Cermet grades

Solid Endmills & Solid Drills Grades

A25 Solid Endmills grade selections
A26 Solid Endmills grades
A27 Solid Drills grade selections
A28 Solid Drills grades

Others (Turning/Milling/Endmills)

A29 Diamond coated grades
A30 DLC coated grades
A31 cBN inserts grades
A36 PCD inserts grades

Chip Breakers

A37 Chip Breaker for Turning
A42 Chip Breaker for Milling
A49 Chip Breaker for Drilling

Grades system

➤ Cutting tool

Uncoated carbide	P	Steel	ST10	ST20	ST30A
	M	Stainless steel	U20		
	K	Cast iron	H01	H05	G10
	S	Titanium alloy	H01	H05	
	N	Aluminum ally/Copper ally	H01	H05	
	H	Hardened steel	H01		

Coated carbide for turning	P	Steel	NC3215	NC3225	NC3120	NC3030	NC5330	PC5300	PC5400	PC3035			
	M	Stainless steel	PC8105	PC8110	PC8115	PC8120	NC9115	NC9125	NC5330	NC9135	PC5300	PC9030	PC5400
	K	Cast iron	NC6310	NC6315	NC5330	PC5300	PC5400						
	S	Heat resistant alloy	PC8105	PC8110	PC8115	PC8120	NC9125	NC9135	PC5300	PC5400			
	N	Non-ferrous metal	ND3000	PD1005	PD1010								
	H	Hardened steel	PC8105	PC8110	PC8115								

Multi-functional	P	Steel	NC3210	NC3225	NC3030	NC5330	PC3035
	M	Stainless steel	PC9030	PC5300			
	K	Cast iron	NC6315	PC5300			
	S	Heat resistant alloy	PC8110	PC5300			
	N	Non-ferrous metal	H01	H05			
	H	Hardened steel	PC8110	PC5300			

Coated carbide for milling	P	Steel	NC5330	NCM535	PC3700	PC5300	PC5400	NCM545
	M	Stainless steel	NC5330	PC5300	PC9530	PC5400	PC9540	
	K	Cast iron	PC6510	NC5330	NCM535	PC5300	PC5400	NCM545
	S	Heat resistant alloy	PC5300	PC5400	PC9540			
	N	Non-ferrous metal	ND3000	PD1005	PD1010			
	H	Hardened steel	PC2005	PC2010	PC2015	PC210F	PC2505	PC2510

Coated carbide for drills, endmills	P	Steel	PC3700	PC5300	PC5335	PC9530	PC9540	NC5330	NCM535
	M	Stainless steel	PC5300	PC5335	PC9530	PC9540			
	K	Cast iron	PC6510	PC5300					
	S	Heat resistant alloy	PC5300	PC9530	PC9540				
	N	Non-ferrous metal	H01						



Grades system

➤ Cutting tool

Turning cermet	P	Steel	CN1500	CN2500
	K	Cast iron	CN1500	CN2500

Coated carbide for turning cermet	P	Steel	CC1500	CC2500
	K	Cast iron	CC1500	CC2500

Milling cermet	P	Steel	CN2500	CN30
----------------	---	-------	--------	------

Solid endmills	P M K	Steel	PC203F	PC215F	PC303S	PC310U	PC315E	PC320	PC320S
	S	Heat resistant alloy	PC320	PC320S	SL				
	N	Non-ferrous metal	ND3000	ND2100	PD1005	PD1010	PC210C	H01	H05S
	H	Hardened steel	PC203F	PC303S	PC310U				

Solid drills	P M K	Steel	PC325U	PC215G	PC315G	PC230F
	S	Heat resistant alloy	PC325T			
	N	Non-ferrous metal	FG2	FA1	ND2100	

cBN	K	Cast iron	DBN500	DBN700A			
	S	Heat resistant alloy	DBN700				
	H	Hardened steel	DB1000	DB2000	DBNX20	DBN250	DBN350

Coated cBN	H	Hardened steel	DNC100	DNC250	DNC350	DNC400
------------	---	----------------	--------	--------	--------	--------

PCD	N	Non-ferrous metal	DP90	DP150	DP200
-----	---	-------------------	------	-------	-------

➤ Wear resistance tool

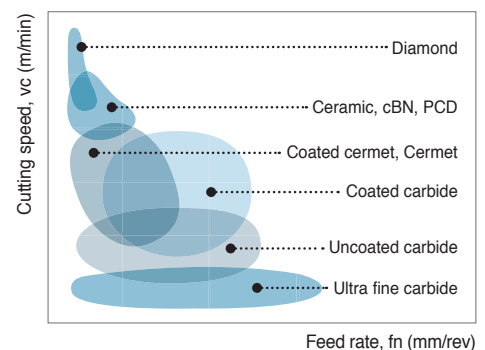
Ultra fine grain cemented carbide	Z	Ultra fine grain cemented carbide	FS1	FA1	FCC
-----------------------------------	---	-----------------------------------	-----	-----	-----

Uncoated carbide	V	Wear parts	D1	D2	D3	G5
	I	Corrosion resistance	IN10	IN20	IN40	

➤ Mining tool

Uncoated carbide	E	General	GR10	GR20	GR30	GR35	GR40
------------------	---	---------	------	------	------	------	------

➤ Application range

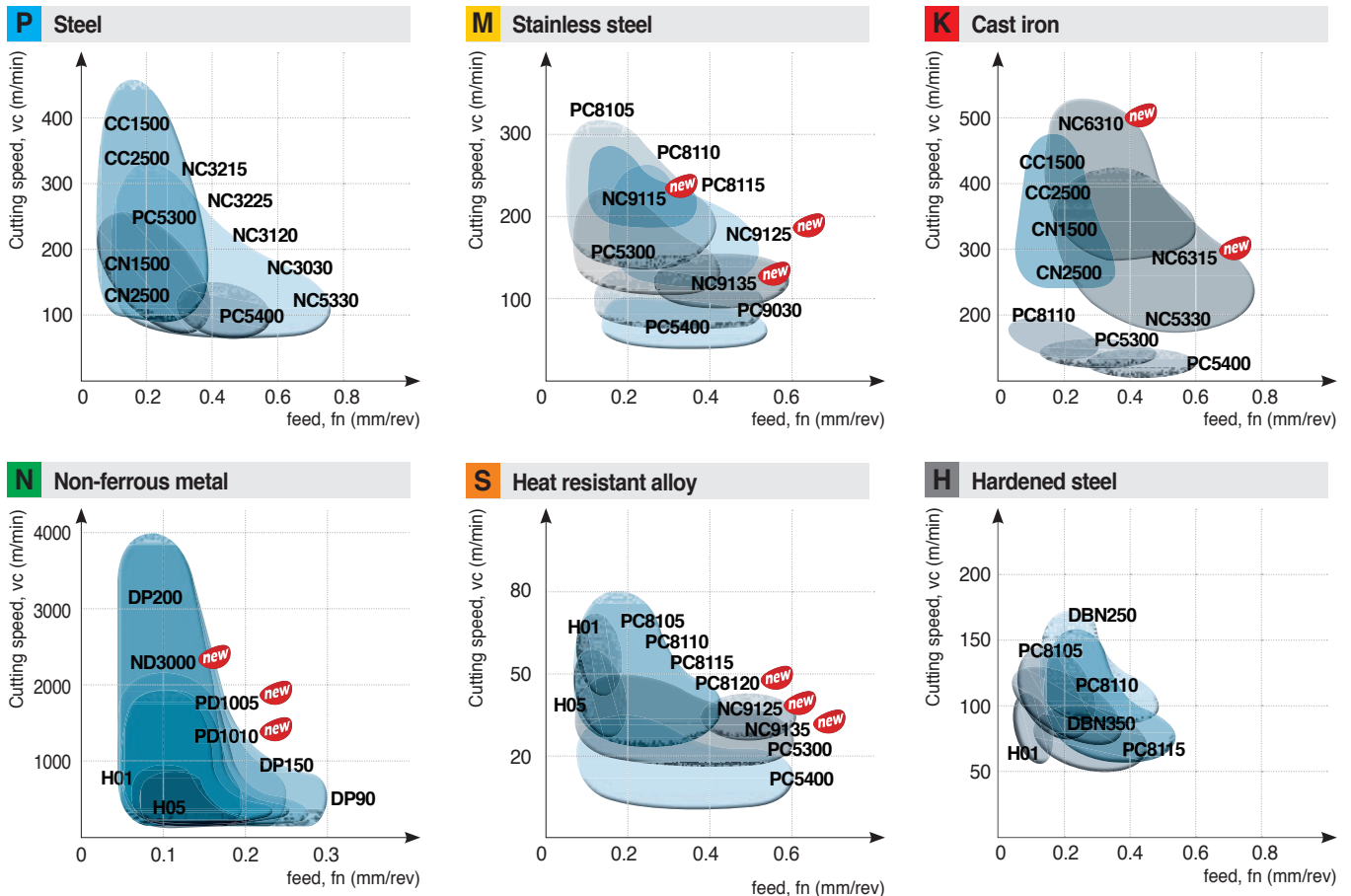


Turning grade selections

Selection system

Workpiece	P					M				K				S				N				H							
	ISO	P01	P10	P20	P30	P40	P50	M10	M20	M30	M40	K01	K10	K20	K30	S01	S10	S20	S30	N01	N10	N20	N30	H01	H10	H20	H30		
Coated carbide			NC3215					PC8105				NC6310 <i>new</i>			PC8105					ND3000 <i>new</i>							PC8105		
			NC3225					PC8110					NC6315		PC8110						PD1005 <i>new</i>						PC8110		
			NC3120					PC8115							PC8115													PC8115	
				NC3030				NC9115 <i>new</i>						NC5330		PC8120 <i>new</i>						PD1010 <i>new</i>						PC8115	
				NC5330				NC9125 <i>new</i>						PC5300		NC9125 <i>new</i>													PC8115
				PC5300				NC9135 <i>new</i>								PC5300													
					PC5400			PC5300								PC5400													
								PC9030																					
									PC5400																				
Cermets		CC1500											CC1500																
		CC2500											CC2500																
		CN1500											CN1500																
			CN2500											CN2500															
cBN / PCD												DBN700			DB7000					DP90						DNC100			
												DBN800								DP150						DNC250			
												DBN500								DP200						DNC400			
																										DNC350			
Uncoated carbide		ST10						U20				H01			H01					H01						H01			
			ST20									H05			H05					H05									
				ST30A									G10								H05								

Application range of turning grades



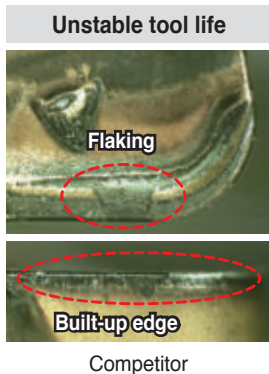
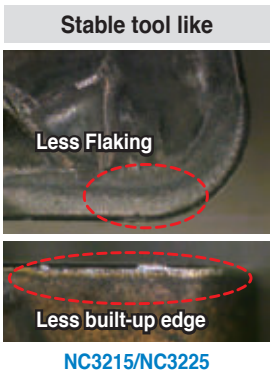
CVD coated grades

NC3215 / NC3225

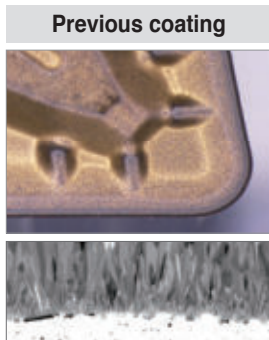
- Universal grade especially for machining forged automobile components and bearing steel both in continuous and interrupted cutting
- Available for all kinds of steels - carbon steel, alloy steel, rolled steel, tool steel, mild steel, bearing steel and other special kinds of steel
- New coating technology increases welding resistance and chipping resistance, which leads to longer tool life

Features

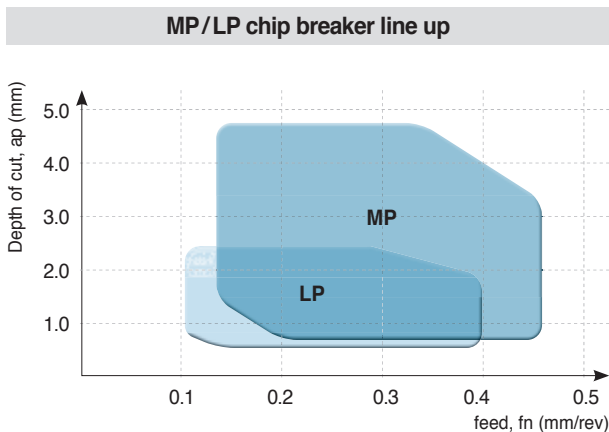
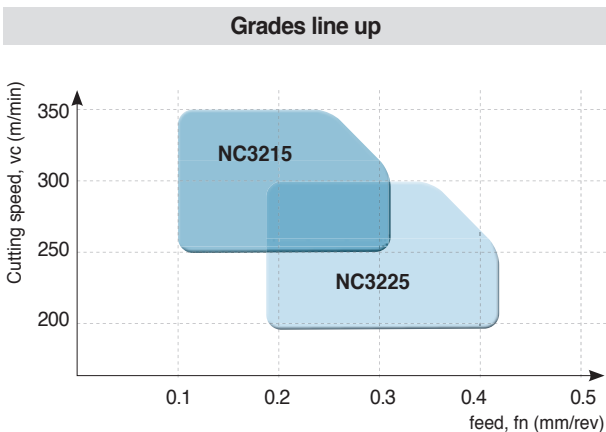
- Stable tool life → Higher production stability
- Longer tool life & Higher removal rate → High cutting conditions and shorter cutting time available
- Ideal combination of a grade and chip breakers → Prolongs tool life → Wide applications ranging from roughing to finishing



• Disperse cutting force → Reduce chipping → Increase tool life → Improved productivity



Application range



CVD coated grades

CVD coated grade for high efficiency and quality turning of cast iron

NC6310 ^{new} / NC6315 ^{new}

- CVD coating with improved wear resistance and chipping resistance.
- Solutions for the most common issues in cast iron machining: Preventing excessive wear on rake and flank surfaces of insert, chipping and burr

Features of NC6310

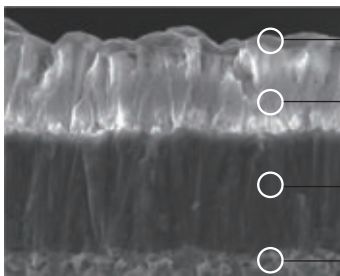
Normal wear on rake surface and nose radius



NC6310

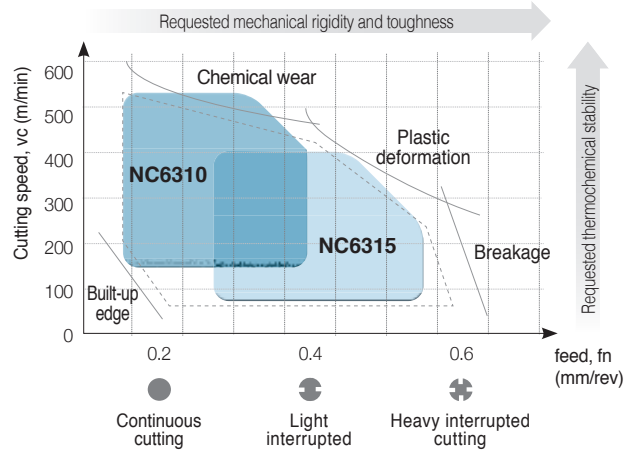


Existing grade (K10)



- Titanium layer with excellent lubrication identifying wear
- Alumina layer specialized for heat resistance
- Titanium layer with improved fracture resistance
- Functional substrate optimized for high speed cast iron machining

Recommended machining range for each grade

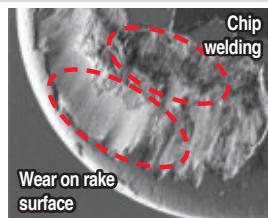


Features of NC6315

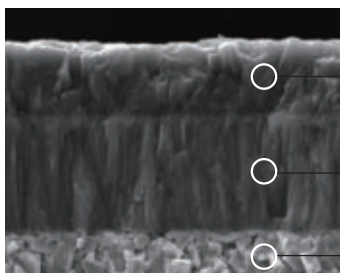
Improved flaking resistance and wear resistance on rake surface



NC6315



Existing grade (K15)



- Alumina layer with better surface finish and improved wear resistance and welding resistance
- Titanium layer with improved fracture resistance
- Functional substrate optimized for high feed and heavy interrupted cast iron machining

Normal wear on flank surface



NC6315



Existing grade (K15)



CVD coated grades

Turning grades for stainless steel

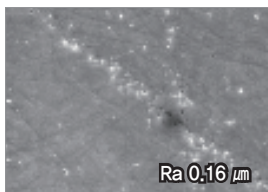
NC9115 ^{new} / NC9125 ^{new} / NC9135 ^{new}

- Optimized for reducing built-up edges, notch wear, plastic deformation and burrs, and for machining stainless steel
- Ideal combination of a grade and MM/RM chip breakers for stable tool life and wide applications ranging from roughing to finishing
- Stable tool life even at high speeds, feeds and depth of cuts (for STS316, vc over 150 m/min available), shortening cutting time
- Excellent versatility responding to workpiece change, covering the austenite, the martensite and the ferrite
- NC9115 is for P20 class, mild steel and forged steel machining.

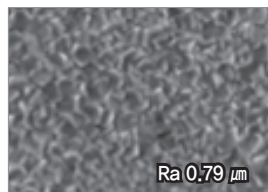
Features

- Improved surface finish thanks to the new lubricative CVD coating

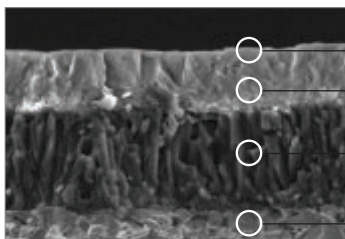
Lubricative coating layer to prevent built-up edge



NC9100 Series



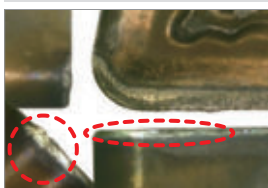
Existing coating



- Top coat with improved welding resistance
- Alumina coating layer for high speed cutting
- Titanium coating layer with stronger resistance to chipping
- Tough substrate optimized for continuous cutting and both light & heavy interruption

- Lubricative coating layers → Improves welding resistance

Inhibited built-up edge and blade damage



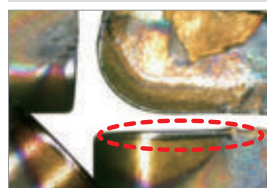
NC9125 (M25)



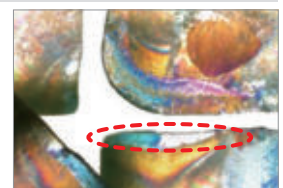
Competitor (M25)

- Coated layers of stronger chipping resistance and the substrate of high toughness → Inhibits notch wear creation

Inhibited wear on notch and relief surface



NC9135 (M35)

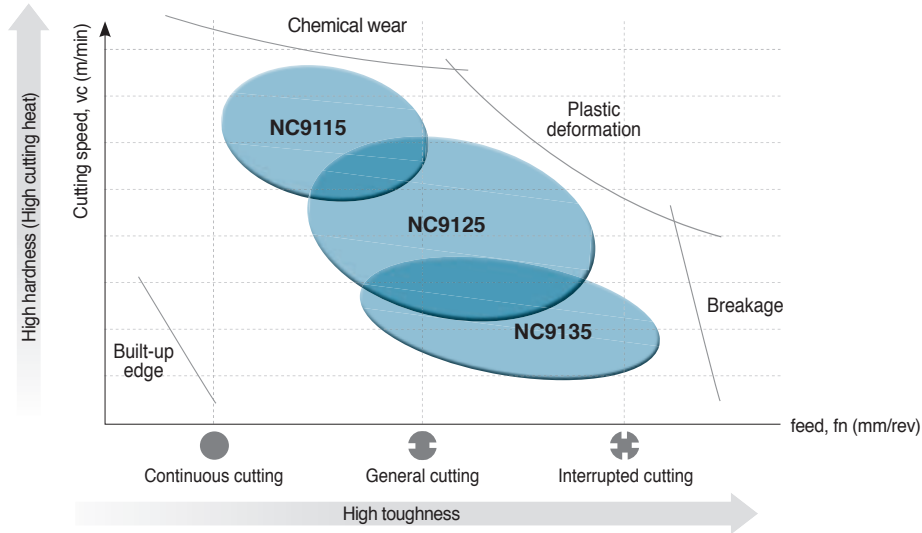


Competitor (M35)

A Turning Grades

CVD coated grades

Grades line up



Recommended grade and chip breaker per stainless steel type

[Austenitic stainless steel]

Grade	Cutting speed (m/min)				
	50	100	150	200	250
NC9115				160	220
NC9125			150	200	
NC9135		100	150		

[Duplex stainless steel]

Grade	Cutting speed (m/min)				
	50	100	150	200	250
NC9115			120	160	
NC9125		100	140		
NC9135		60	100		

[Ferritic/Martensitic stainless steel]

Grade	Cutting speed (m/min)				
	50	100	150	200	250
NC9115			150		250
NC9125		120		220	
NC9135		100	150		

[Precipitation hardened (PH) stainless steel]

Grade	Cutting speed (m/min)				
	50	100	150	200	250
NC9115	50	110			
NC9125	40	110			
NC9135	30	100			



Selection system of CVD coated grade

Workpiece	Machining types	Recommended grade	Recommended cutting speed (m/min)	ISO	Application range
P Steel	Continuous cutting	NC3215	295 (170~420)	P10	
		NC3225	260 (150~370)	P15	← NC3215 →
	Interrupted cutting	NC3120	260 (120~370)	P20	
		NC3030	205 (120~290)	P30	
		NC5330	185 (110~260)	P35	
M Stainless steel	Continuous cutting	NC9115 ^{new}	240 (220~260)	M10	
		NC9125 ^{new}	210 (190~230)	M20	
	Interrupted cutting	NC9135 ^{new}	180 (160~200)	M30	
				M40	
K Cast iron	Continuous cutting	NC6310 ^{new}	380 (300~500)	K10	
		NC6315	280 (200~400)	K20	
	Interrupted cutting	NC5330	190 (110~270)	K30	
S HRSA	Continuous cutting	NC9125 ^{new}	40 (20~60)	S10	
	Interrupted cutting	NC9135 ^{new}		S20	

The features of CVD coated grades

CVD Coated grades	ISO	Features
NC3215	P10~P15	<ul style="list-style-type: none"> Continuous machining of general steel and forged steel at high speed Substrate with excellent thermal crack/plastic deformation resistance, coating with improved chipping resistance for continuous machining · MT-TiCN + Al₂O₃ + TiN
NC3225	P20~P25	<ul style="list-style-type: none"> Universal grade for general steel and forged steel 1st recommended grade for general machining with the use of high toughness substrate and coating layer with improved welding/chipping resistance · MT-TiCN + Al₂O₃ + TiN
NC3120	P20~P25	<ul style="list-style-type: none"> Medium to roughing for steel Combining excellent fracture resistance substrate with chipping resistance and heat resistance Al₂O₃ increased stability · MT-TiCN + TiC + Al₂O₃
NC3030	P25~P35	<ul style="list-style-type: none"> Medium to low speed machining of steel and interrupted roughing Harmony between substrate with excellent wear/fracture resistance and Al₂O₃ film with excellent thermal/chipping resistance Increased stability in wide ranges of cutting conditions · MT-TiCN + TiC + Al₂O₃ + TiN
NC5330	P30~P35 M25~M35 K15~K25 S15~S25	<ul style="list-style-type: none"> Stainless Steel - General cutting for mild steel & forging steel Excellent cutting performance in hard to cut materials which are vulnerable to built up edge, due to the high tough substrate with improved fracture resistance and the coated layers · MT-TiCN + Al₂O₃ + TiN
NC9115 ^{new}	M10~M20	<ul style="list-style-type: none"> High speed cutting for ferritic and martensitic stainless steels · MT-TiCN + Al₂O₃ + TiN
NC9125 ^{new}	M20~M30	<ul style="list-style-type: none"> General cutting of stainless steel and heat resistant alloys · MT-TiCN + Al₂O₃ + TiN
NC9135 ^{new}	M30~M40	<ul style="list-style-type: none"> Interrupted cutting of stainless steel and heat resistant alloys · MT-TiCN + Al₂O₃ + TiN
NC6310 ^{new}	K01~K10	<ul style="list-style-type: none"> High speed and continuous cutting of grey cast iron Increased tool life due to coating layer with high wear resistance · MT-TiCN + Al₂O₃ + TiN
NC6315	K10~K20	<ul style="list-style-type: none"> Universal grade for ductile and gray cast Iron Excellent performance thanks to the alumina (Al₂O₃) coating's improved grip on the tough substrate · MT-TiCN + Al₂O₃



PVD coated grades

Turning grade for heat resistant alloy and stainless steel

PC8105

- Micro grain carbide minimizes chipping of cutting edge due to enhanced edge strength
- Latest PVD coating technology with high hardness and high temperature oxidation resistance
- Excellent tool life when finishing heat resistant alloys and stainless steels at high speeds

PC8110

- Substrate with superior wear resistance and plastic deformation resistance at high temperature
- PVD coating technology with high hardness and oxidation resistance at high temperature
- Long tool life when machining heat resistant alloy and stainless steel at high speed

PC8115

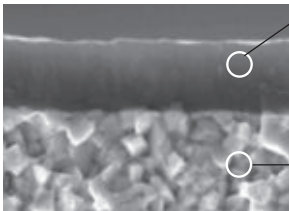
- Ultra fine matrix technology increases wear resistance and chipping resistance
- PVD coating technology with high hardness and oxidation resistance at high temperature
- Strong cutting edge and excellent chipping resistance guarantees stable machining
- Long tool life when machining heat resistant alloy and stainless steel at middle to low speed and medium cutting to roughing

PC8120 new

- Control technology for uniform ultra-fine substrate increases wear resistance and chipping resistance
- The new PVD dioxide film enhances oxidation resistance and heating resistance
- Special technology of coating surface treatment prevents chipping and realizes stable machining

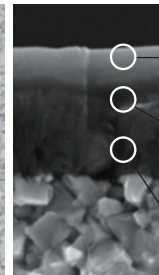
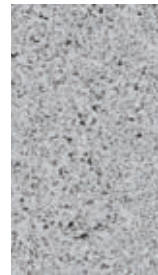
Features

Features of PC8105/10/15 series



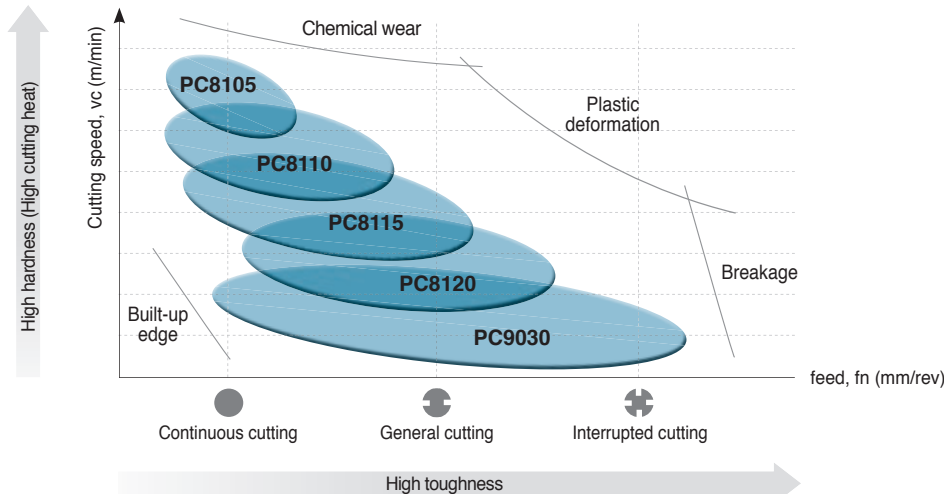
- It prevents wear at a high temperature to apply excellent surface roughness and coating with oxidation resistance and high hardness
- It improves wear resistance to equalize submicron matrix, secure stability between corners and improve chipping- and wear resistance

PC8120



- PVD multi-layer → Reducing cracks
- PVD oxidation layer → Good oxidation resistance and heating resistance
- PVD nitride → Good wear resistance

Grades line up



Selection system of PVD coated grade

Workpiece	Machining types	Recommended grade	Recommended cutting speed (m/min)	ISO	Application range	
P	Steel	PC5300	175 (100~250)	P30	PC5300	
			145 (80~120)	P40		PC5400
	Interrupted cutting	PC5400	125 (80~160)	P50		
M	Continuous cutting	PC8105	175 (120~230)	M01	PC8105	
		PC8110	160 (110~210)	M10		PC8110
		PC8115/8120 ^{new}	150 (100~200)	M20		
	Interrupted cutting	PC5300	135 (80~190)	M30	PC5300	
		PC9030	130 (80~180)	M40		PC9030
		PC5400	110 (80~140)	M50		
K	Continuous cutting	PC8110	135 (95~180)	K10	PC8110	
				K20		PC5300
	Interrupted cutting	PC5300	105 (75~140)	K30	PC5400	
		PC5400	90 (65~120)	K40		
S	Continuous cutting	PC8105	55 (40~70)	S01	PC8105	
		PC8110	50 (35~65)	S10		PC8110
		PC8115/8120 ^{new}	45 (30~60)	S20		
	Interrupted cutting	PC5300	40 (20~60)	S30	PC5300	
		PC5400	35 (20~50)	S40		PC5400
H	Interrupted cutting	PC8105	110 (80~140)	H01	PC8105	
		PC8110	100 (70~130)	H05		PC8110
		PC8115	90 (65~115)	H10		

The features of PVD coated grades

PVD Coated grades	ISO	Features
PC8105	M05~M15 S01~S10 H01~H05	<ul style="list-style-type: none"> For high speed and continuous finishing of hard-to-cut materials and STS Excellent cutting performance with high wear resistance and oxidation resistance Ultra fine substrate and the new TiAlN coating layer
PC8110	M10~M20 K10~K20 S05~S15 H05~H10	<ul style="list-style-type: none"> For high speed and continuous medium cutting of hard-to-cut materials and STS Excellent tool life with high wear/plastic deformation resistance at high temperature New TiAlN coating layer and substrate with excellent thermal resistance
PC8115	M15~M25 S10~S20 H10~H15	<ul style="list-style-type: none"> For medium to low speed and medium to rough cutting of hard-to-cut materials and STS Excellent tool life with high wear resistance and chipping resistance Ultra fine substrate and the new TiAlN coating layer
PC8120 ^{new}	M15~M25 S10~S20	<ul style="list-style-type: none"> For hard-to-cut materials and STS roughing Applied ultra-fine substrate and new PVD oxidation layer Better chipping resistance and fracture resistance than PC8115
PC5300	P30~P40 M20~M30 K20~K25 S15~S25	<ul style="list-style-type: none"> Universal grade for stainless, HRSA, steel and interrupted cast iron machining High chipping and welding resistance for longer tool life New TiAlN coating and ultra fine grain substrate adopted
PC9030	M25~M35	<ul style="list-style-type: none"> Medium, roughing and heavy interrupted cutting for stainless steel TiAlN coating and ultra fine grain substrate adopted High chipping and welding resistance for stable machining
PC5400	P35~P45 M30~M40 K30~K35 S25~S35	<ul style="list-style-type: none"> For medium cutting for hard-to-cut materials, stainless steel, steel, and cast iron at medium or low speed Stable machinability with chipping resistance, fracture resistance and welding resistance Ultra fine substrate with high toughness and new AlCrN layer

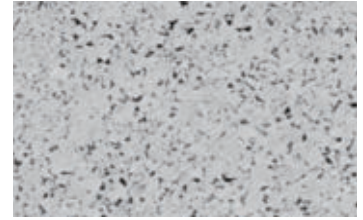
A Turning Grades

Uncoated carbide grades

Uncoated carbide grades for turning application of titanium

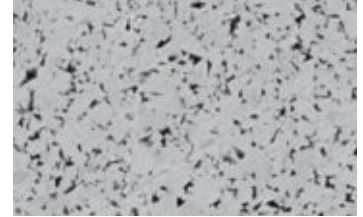
H01

- Increased wear resistance and chipping resistance with the use of ultra fine substrate
- Improved welding resistance and chipping resistance with the use of special surface treatment and sharp cutting edge of VP chip breaker
- Excellent tool life when finishing titanium alloy at high speed

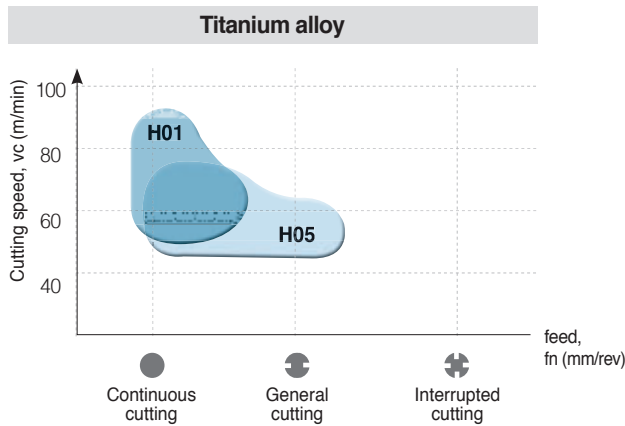


H05

- The 1st recommended grade for machining titanium alloy in a variety of cutting conditions
- Improved welding resistance and chipping resistance with the use of special surface treatment and sharp cutting edge of VP chip breaker
- Ideal for medium cutting of titanium alloy



Grades line up



Selection system of uncoated carbide grades

Workpiece	Recommended grade	Recommended cutting speed (m/min)	ISO	Application range
P Steel	ST10	110 (70~140)	P10	ST10
	ST20	80 (50~110)	P20	ST20
	ST30A	70 (40~90)	P30	ST30A
M Stainless steel	U20	70 (40~90)	M25	U20
K Cast iron	H01	105 (60~140)	K01	H01
	H05	105 (60~140)	K10	H05
	G10	90 (50~120)	K20	G10
N Aluminum alloy Copper alloys	H01	600 (450~750)	N10	H01
	H05	425 (320~530)	N20	H05
S Titanium alloy	H01	55 (40~70)	S01	H01
	H05	50 (35~65)	S10	H05
H High hardness steel	H01	80 (55~105)	H10	H01

Main composition and application range

Workpiece	Composition	Features	Workpiece
P	WC-TiC-TaC-Co	Heat resistance, excellent plastic deformation resistance	Carbon steel, Alloy steel, Stainless steel
M	WC-TiC-TaC-Co	General tools stable heat resistance with strength	Carbon steel, Alloy steel, Stainless steel, Cast steel
K	WC-Co	High strength and superior wear resistance	Cast iron, Non-ferrous metal, Plastic, etc.
S	WC-Co	Excellent wear resistance and chipping resistance	Titanium alloy



🔗 The physical properties of uncoated carbide grades

Workpiece	Grade	Hardness (HRA)	TRS (kgf/mm ²)	Young's modulus (10 ³ kgf/mm ²)	Thermal expansion coefficient (10 ⁻⁶ /°C)	Thermal conductivity (cal/cm · sec·°C)
P	ST10	92.1	175	48	6.2	25
	ST20	91.9	200	56	5.2	45
	ST30A	91.3	230	53	5.2	-
M	U20	91.1	210	-	-	88
	ST30A	91.3	230	53	5.2	-
K	H01	92.9	210	66	4.7	109
	G10	90.9	250	63	-	105
S	H01	92.9	210	66	4.7	109
	H05	91.8	250	-	-	-

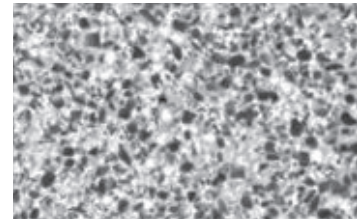
1KPa = 102kgf/m², 1w/mk = 2.39×10⁻³cal/cm·sec·°C

Cermets grades

Solution for turning application of steel

CN1500

- For continuous machining of cold/hot forged steel and Sintered ferrous alloy at high speed and low depth of cut
- Excellent wear resistance and crater resistance
- Improved surface roughness acquired by optimized cutting edges



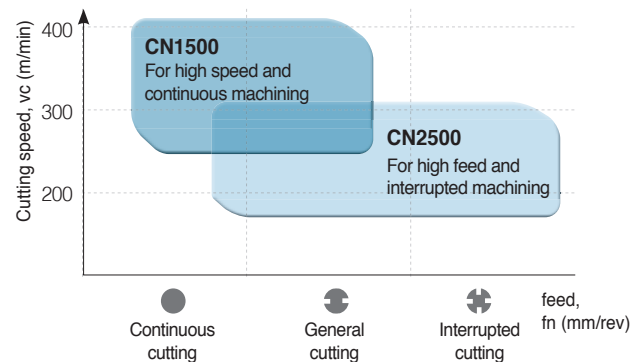
CN2500

- For high interrupted machining of cold/hot forged steel and Sintered ferrous alloy at high feed and high depth of cut
- Excellent resistance against chipping, fracture and thermal crack
- Improved surface roughness acquired by optimized cutting edges

🔗 Recommended cutting condition

Division	Workpiece	Grade	Recommended cutting speed (m/min)		
			Minimum	Recommended	Maximum
Turning	SM10C, SS440	CN1500	150	270	400
		CN2500	130	240	350
	SM45C	CN1500	150	250	350
		CN2500	130	220	300
	SCM440, Sintered Fe ferrous alloy	CN1500	120	220	300
		CN2500	100	200	250

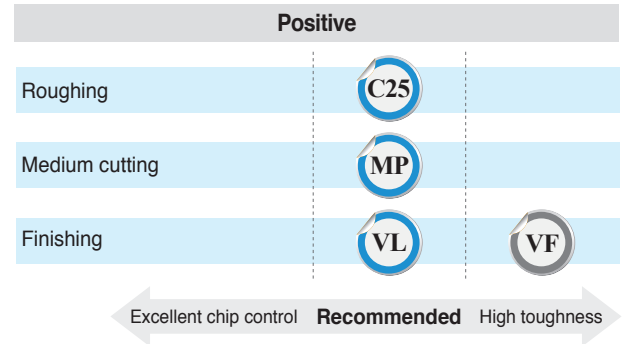
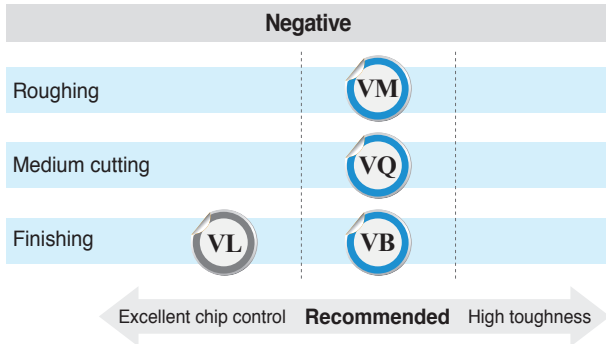
🔗 Grades line up



A Turning Grades

Cermet grades

Chip breakers line up



Selection system of cermet grades

Workpiece	Machining types	Recommended grade	Recommended cutting speed (m/min)	ISO	Application range
P	Steel	Continuous cutting	250 (150~350)	P10	
		Interrupted cutting	220 (130~300)	P20	
				P30	

Comparison of chip breakers

Insert types	Machining types	Application range	Chip breakers				
			KORLOY	Competitor A	Competitor B	Competitor C	Competitor D
Nega type	Continuous cutting	For machining mild steel with enhanced chip control	VL	FA	GP	TF	FA
	General cutting	For low interrupted cutting with stronger cutting edges than VG chip breaker	VB	FG	XP CQ	TSF TS	LU SE
	General cutting	For medium cutting to finishing at low interruption	VQ	MC	HQ	AS, ZM	SU
	Interrupted cutting	For medium cutting to roughing at high interruption	VM	MT	HS	TM	GU
Posi type	Continuous cutting	For machining mild steel with enhanced chip control	VL	FA	GP	PF	FP
	Continuous cutting	Enhanced chip control when machining internal diameter with stronger cutting edges than VL chip breaker	VF	FG-PC	HQ	PS	LU
	General cutting	For medium cutting to finishing at low interruption	MP	FG	HQ	PS	LU
	Interrupted cutting	For medium cutting to roughing at high interruption	C25	MT	GK	24	SC



Coated cermet grades

Coated cermet for machining carbon steel, alloy steel and sintered ferrous components

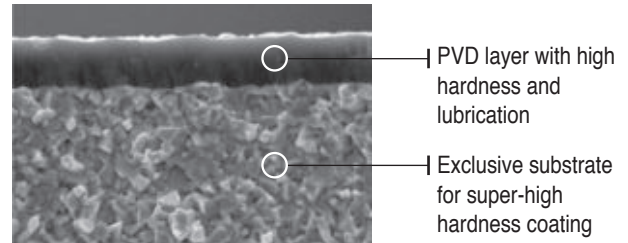
CC1500 **new**

- Maximized resistance to built-up edge and oxidation in continuous cutting at high speeds and low depth of cuts
- Superior wear resistance vs. existing tools in continuous cutting of carbon steel and alloy steel

CC2500 **new**

- Maximized resistance to built-up edge and oxidation in interrupted cutting at high feeds and high depth of cuts
- Superior impact resistance vs. existing tools in interrupted cutting of carbon steel and alloy steel

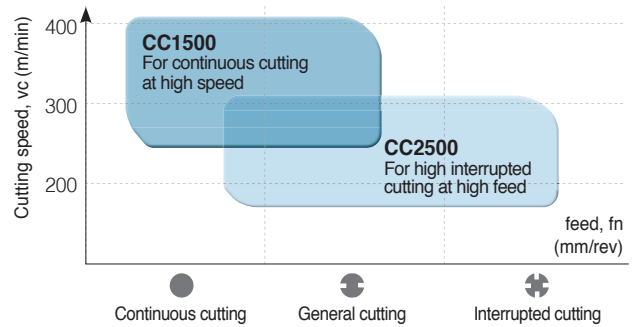
Features



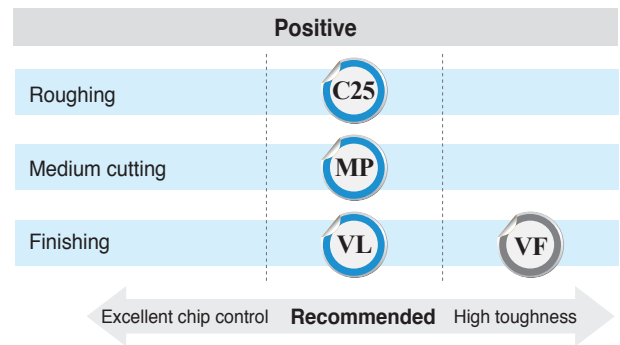
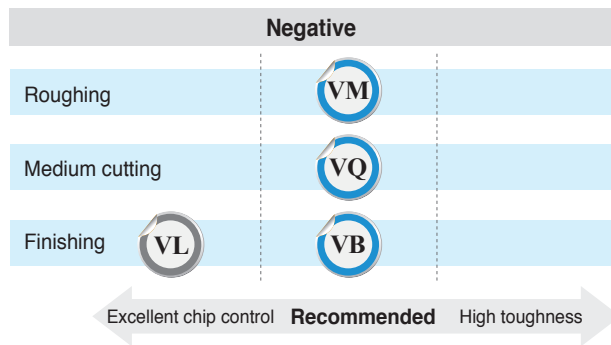
Recommended cutting condition

Division	Workpiece	Grade	Recommended cutting speed (m/min)		
			Minimum	Recommended	Maximum
Turning	SM10C, SS440	CC1500	200	350	450
		CC2500	180	290	400
	SM45C	CC1500	200	300	400
		CC2500	180	270	350
	SCM440, Sintered Fe ferrous alloy	CC1500	180	270	350
		CC2500	150	250	300

Grades line up



Chip breakers line up



Selection system of coated cermet grades

Workpiece	Machining types	Recommended grade	Recommended cutting speed (m/min)	ISO	Application range
P Steel	Continuous cutting	CC1500	325 (200~450)	P10	CC1500
	Interrupted cutting	CC2500	265 (180~350)	P20, P30	CC2500
K Cast iron	Continuous cutting	CC1500	270 (180~350)	K10	CC1500
	Interrupted cutting	CC2500	250 (150~300)	K20	CC2500

The features of coated cermet grade

Coated cermet	ISO	Features
CC1500	P10~P20 / K05~K15	• PVD coated Cermet • Light cutting for steel and cast iron in high speed machining • Optimized for precision boring
CC2500	P20~P30 / K10~K20	• PVD coated Cermet • Light cutting for steel and cast iron in medium or high speed machining • Dry and wet cutting are available

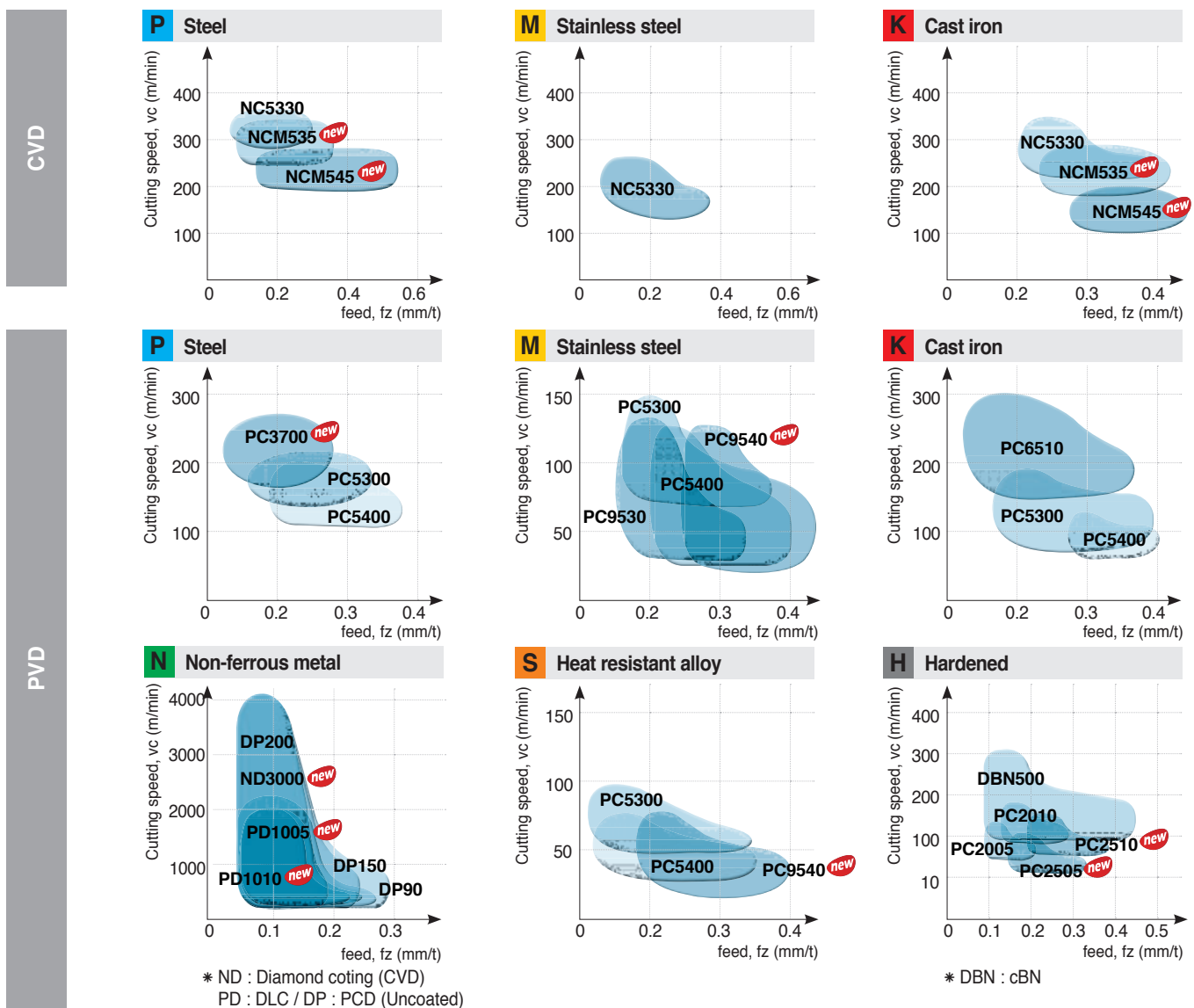


Milling grade selections

Selection system

피삭재	P Steel					M Stainless steel				K Cast iron				S HRSA				N Nonferrous			H Hardened					
ISO	P10	P20	P30	P40	P50	M10	M20	M30	M40	K01	K10	K20	K30	K40	S10	S20	S30	S40	N01	N10	N20	N30	H01	H10	H20	H30
Coated carbide			NC5330																							
Cermet																										
cBN / PCD																										
Uncoated carbide																										

Application range



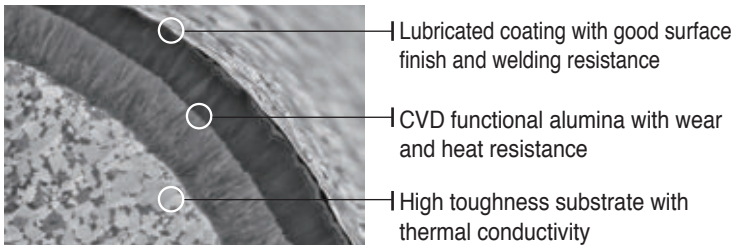
CVD coated grades

Milling Solutions for Steel and Cast Iron

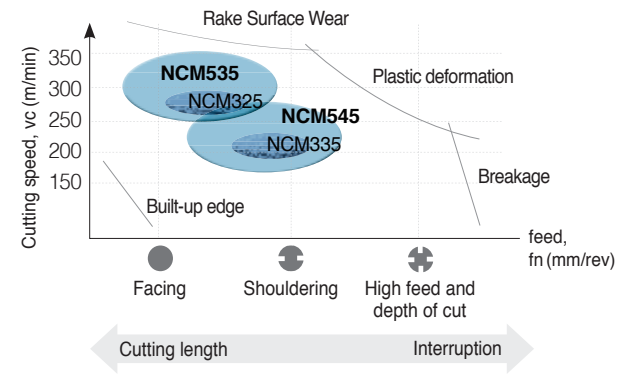
NCM535 ^{new} / NCM545 ^{new}

- Improved chipping resistance / heat and crack resistance: Applied after treatment with good chipping resistance and heat and crack resistance
- Improved wear and heat resistance: Applied high toughness substrate and high functional CVD alumina

Features



Guideline for grade application



Selection system of CVD coated grades

Workpiece	Machining types	Recommended grade	Recommended cutting speed (m/min)	ISO	Application range
P Steel	Continuous cutting	NC5330	200 (150~250)	P20 P25	NC5330
	Continuous cutting	NCM535 ^{new}	300 (200~400)	P30 P35	NCM535 ^{new}
	Interrupted cutting	NCM545 ^{new}	200 (150~250)	P40 P45	NCM545 ^{new}
M Stainless steel	Continuous cutting	NC5330	150 (120~180)	M10 M20	NC5330
K Cast iron	Continuous cutting	NC5330	200 (150~250)	K10 K20	NC5330
		NCM535 ^{new}	250 (200~300)	K30	NCM535 ^{new} NCM545 ^{new}

The features of CVD milling grades

CVD Coated grades	ISO	Features
NC5330	P20~P30 M20~M30 K15~K25	<ul style="list-style-type: none"> • For high speed milling of steel and stainless steel • Superior wear resistance and chipping resistance grade for steel and stainless steel • MT-TiCN + Al₂O₃ + TiN
NCM535 ^{new}	P30~P40 K20~K30	<ul style="list-style-type: none"> • Rising CVD milling grade for high productivity in large steel and cast iron machining at high speed • High toughness and thermal conductivity substrate and high functional CVD coating layer with heat resistance • High chipping resistance and heat and crack resistance from excellent after treatment • MT-TiCN + Al₂O₃
NCM545 ^{new}	P40~P50 K30~K40	<ul style="list-style-type: none"> • For steel and cast iron milling with high toughness • High toughness substrate and high functional CVD coating layer • High chipping resistance and heat and crack resistance from excellent after treatment • MT-TiCN + Al₂O₃



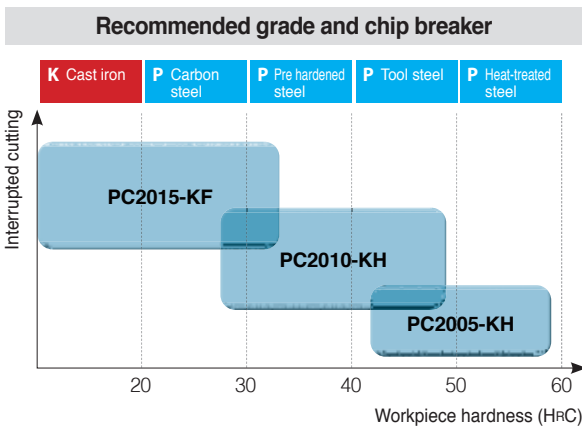
PVD coated grades

PVD coated grades for finishing high hardened steel

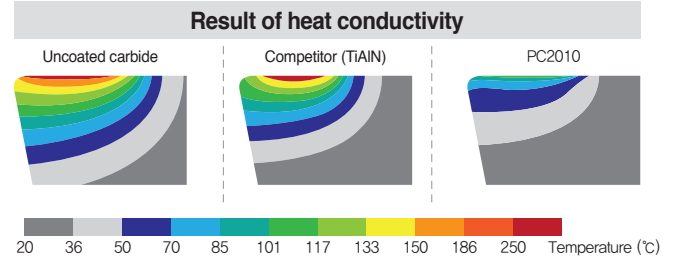
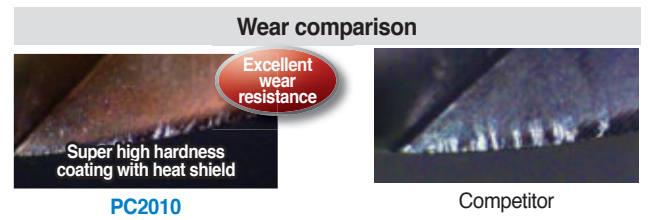
PC2005 / PC2010 / PC2015

- Finishing grade lineup for tool steel and plastic die steel
- PC2005 with extremely hard substrate and coatings
- PC2010 with high hardened cutting edges, ideally suited for pre-hardened steel and interrupted cutting
- PC2015 for carbon steel and casting machining, demonstrating excellent performance in hard-to-cut materials

Application guideline per workpiece



Features



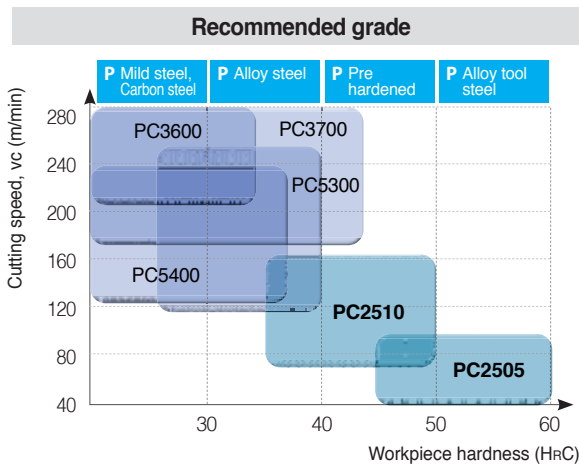
- Heat shield coating was applied to prevent thermal crack.
- Ultra fine WC was combined with high contents cobalt to be optimized for machining pre hardened steel.

PVD coated grades for roughing high hardened steel

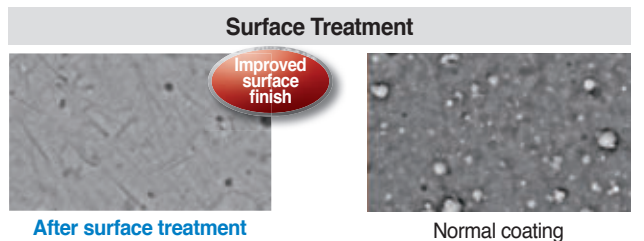
PC2505 ^{new} / PC2510 ^{new}

- Roughing grade series for high hardened steel
- PC2505 with excellent wear resistance, ideal for machining die steel and high hardened steels over HRC50
- PC2510 with stabilized toughness, ideal for interrupted cutting of high hardened steel and wet cutting accompanied by massive thermal shock

Application guideline per workpiece



Features



PVD coated grades

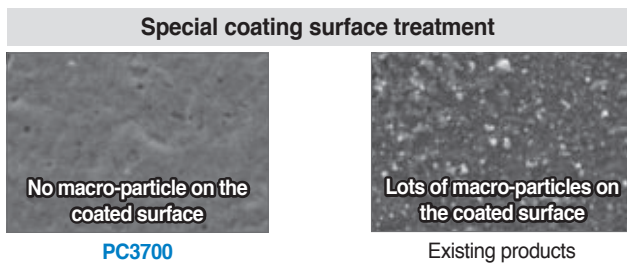
Milling grade specialized for steel

PC3700 new

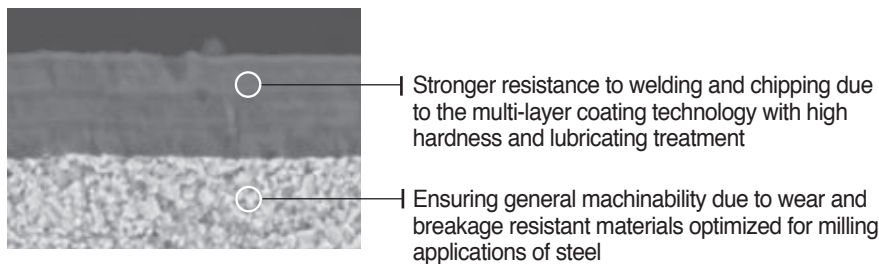
- Excellent chip removal rate due to a tough substrate specialized for steel, and lubricative PVD coating of high-hardness
- A highly chipping-resistant grade for minimized deviation and extended tool life under various cutting conditions

Features

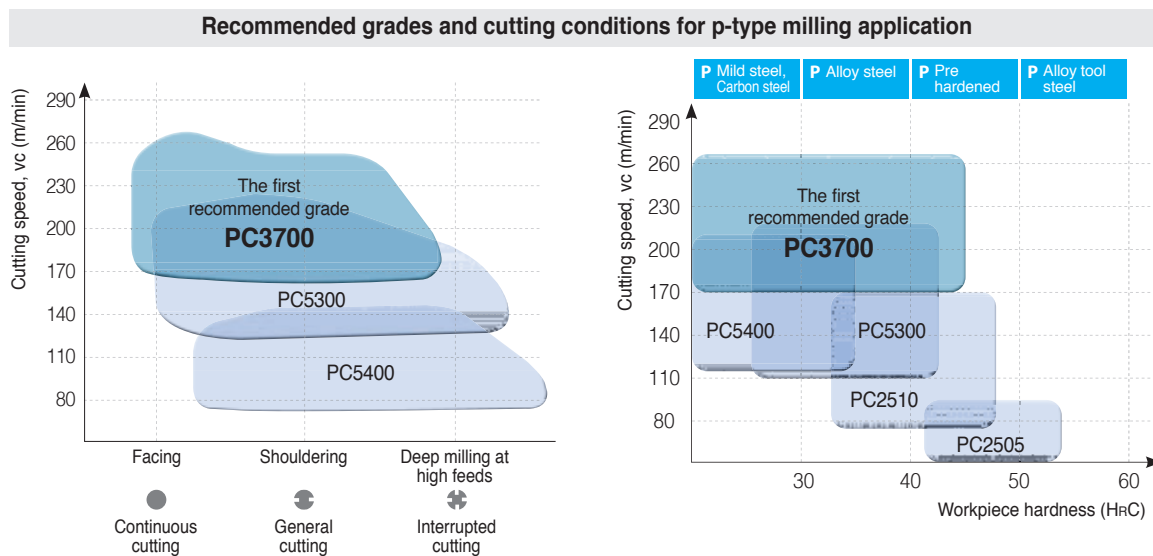
- Smooth surface due to special surface treatment
→ Smooth chip evacuation, improved chipping resistance and surface finish of the workpiece



- Substrate for general milling applications of steel and PVC coating treatment



Application range



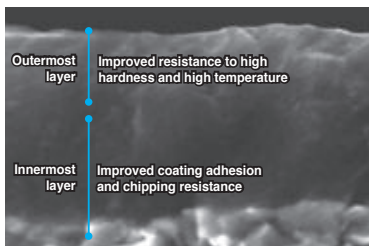
PVD coated grades

Universal PVD grade

PC5300

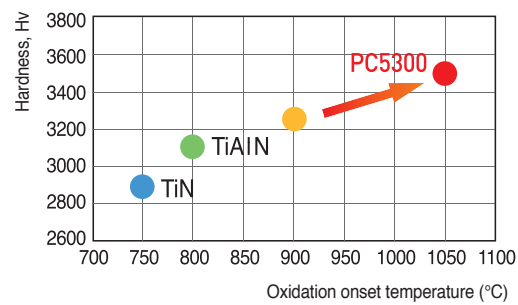
- Advanced PVD coating with high hardness and high temp stability
- High tough substrate and coating films produce excellent surface finish
- Universal tooling capability covering P, M, K, S with this single grade, PC5300
- Stable machining resulting from excellent edge hardness and chipping resistance

Features



- Latest PVD coating technology developed by KORLOY
- New concept of coating equipped with high temperature oxidation resistance and high hardness

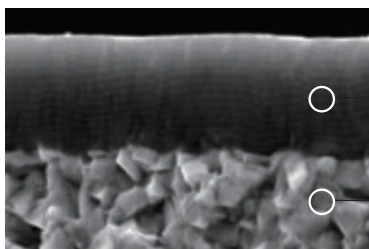
High temp properties



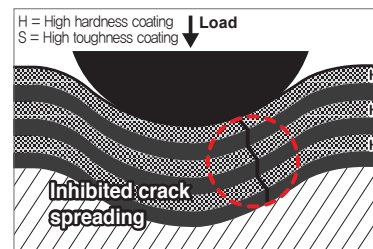
PC5400

- New PVD coating layer with high toughness and lubrication
- High adhesive strength and toughness between the substrate and coating layer
- Excellent cutting edge strength and chipping resistance ensure stable machinability for P, M, K, S.

Features



- Improved lubrication
- High toughness and strong adhesion
- Ultrafine substrate of high toughness



Crack creation on the coating surface after leaving an indentation by 60kg



Normal coating



High toughness coating



PVD coated grades

Optimal PVD grade for medium to rough cutting and highly interrupted milling in stainless steel

PC9540 **new**

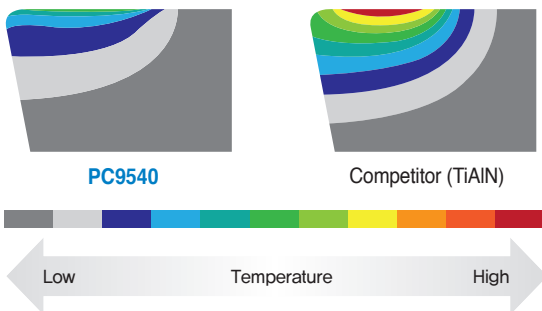
- Longer tool life due to higher breakage resistance applying high toughness substrate controlling crack growth
- Excellent and new PVD dioxide film with oxidation and heat resistance overcoming the limit of hard-to-cut materials machining
- Stable machinability by preventing welding and chipping due to applying special coating surface treatment

Features

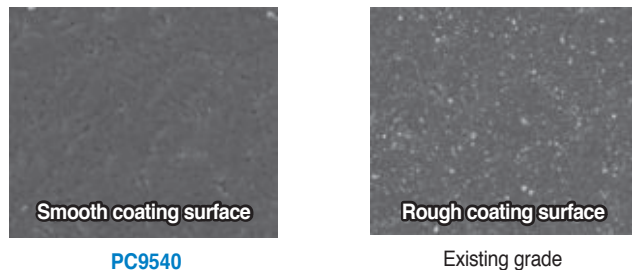


- Improved surface finish → Good welding resistance
- PVD multilayer → Controlling crack growth
- PVD dioxide film → Good oxidation and heat resistance
- PVD nitride film → Good wear resistance
- High toughness substrate → Good breakage resistance

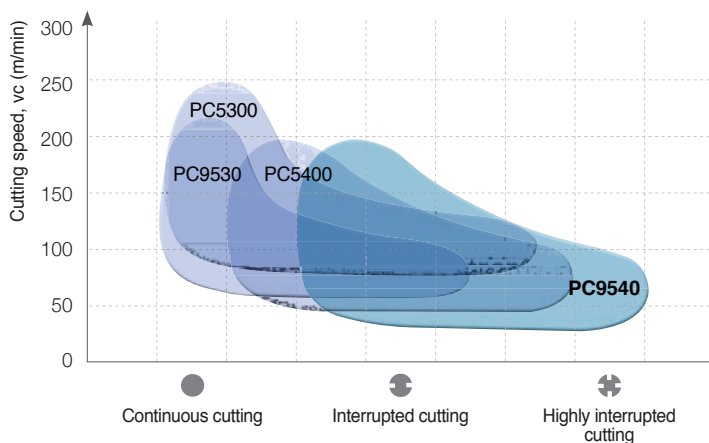
New PVD dioxide film (comparison of thermal conductivity)



Special coating surface treatment technology



Application range



Selection system of PVD coated grades

Workpiece	Machining types	Recommended grade	Recommended cutting speed (m/min)	ISO	Application range
P Steel	Continuous cutting	PC3600	235 (180~290)	P20	
		PC3700 ^{new}	235 (180~290)	P30	
	Interrupted cutting	PC5300	195 (150~240)	P40	
		PC5400	145 (80~210)	P50	
M Stainless steel	Continuous cutting	PC5300	130 (100~160)	M20	
		PC9530	130 (100~160)	M30	
	Interrupted cutting	PC5400	120 (95~155)	M40	
		PC9540 ^{new}	110 (80~140)	M50	
K Cast iron	Continuous cutting	PC6510	180 (140~230)	K01 K10	
		Interrupted cutting	PC5300	145 (110~180)	
	PC5400		125 (85~160)	K30	
	S HRSA	Continuous cutting	PC5300	55 (40~70)	
Interrupted cutting			PC5400	40 (30~50)	S30
		PC9540 ^{new}	40 (30~50)	S40	
H High hardness steel		Continuous cutting	PC2005	60 (40~80)	H01
	PC2010		55 (40~70)	H10	
	PC2015		50 (35~65)	H20	
	PC210F		50 (35~65)	H30	

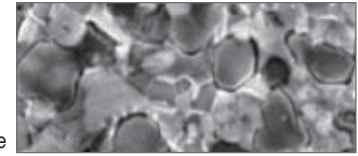
The features of PVD coated grades

PVD Coated grades	ISO	Features
PC3600	P20~P30	<ul style="list-style-type: none"> Milling grade for medium and roughing of steel New coating layer with superior wear resistance and oxidation resistance with high toughness substrate
PC3700 ^{new}	P30~P40	<ul style="list-style-type: none"> Exclusive grade for milling grade Lubricated and high hardness multi-layered coating
PC5300	P30~P40 M20~M30 S15~S25	<ul style="list-style-type: none"> Superior universal grade for steel, cast iron, hard to cut material, stainless steel New coating and ultra fine grain provide wear resistance and oxidation resistance TiAlN Series new coating
PC5400	P35~P45 M30~M40 S25~S35	<ul style="list-style-type: none"> Universal grade for interrupted machining of steel, cast iron, hard-to-cut materials and stainless steel with stable machinability New coating layer with high toughness and lubrication on ultra fine grain substrate with high toughness AlCrN series new coating
PC6510	K05~K15	<ul style="list-style-type: none"> High speed milling grade for cast iron and aluminum K-Gold coating
PC9530	M25~M35 S20~S30	<ul style="list-style-type: none"> Medium to rough cutting of hard to cut materials such as stainless steel, Cr-Ni steel, etc. The toughest sub-micron substrate provides excellent cutting performance at high feed TiAlN coating
PC9540 ^{new}	M35~M45 S30~S40	<ul style="list-style-type: none"> Exclusive high toughness grade for stainless steel milling PVD dioxide film with good heat resistance
PC2005	H01~H10 P01~P10 K01~K10	<ul style="list-style-type: none"> Exclusive for Laser Mill in milling of high hardness workpieces and press mold steel Utmost wear resistance due to high hardness substrate and coating Ultra high hardness K-Brown coating
PC2010	H05~H15	<ul style="list-style-type: none"> Exclusive for Laser Mill in milling of pre hardened steel and plastic mold steel High hardness enhanced cutting edges due to ultra fine WC and high contents binder for expanding application range to high hardness steel and pre hardened steel Ultra high hardness K-Brown coating
PC2015	H10~H20	<ul style="list-style-type: none"> Exclusive for Laser Mill in milling of carbon steel and cast Highly lubricative K-SILVER coating Lubricative coating layer and high contents substrate for machining mild steel and hard-to-cut cast materials
PC210F	H10~H20 P25~P35 K15~K25 M15~M25 S10~S20	<ul style="list-style-type: none"> High speed milling grade for hardened steel, cast iron, and stainless steel(Laser Mill) New coating and ultra fine grain provide wear resistance and oxidation resistance TiAlN Series new coating
PC2505 ^{new}	H01~H10	<ul style="list-style-type: none"> Roughing grade for high hardened steel and pressed die steel Excellent wear resistance ideal for machining die steel and high hardened steel over HRC50
PC2510 ^{new}	H05~H15	<ul style="list-style-type: none"> Roughing grade for pre-hardened steel and plastic die steel Stabilized toughness ideal for interrupted cutting of high hardened steel and wet cutting accompanied by massive thermal shock



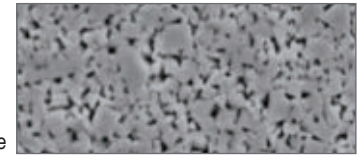
Uncoated carbide grades

- Features**
- Due to KORLOY's advanced sintering technology, our uncoated carbide grades have a fine alloy structure which is necessary to get superior quality from a uncoated cutting tool

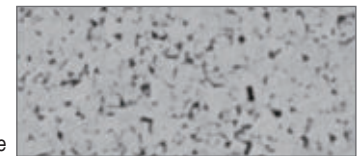


P type

- Advantages**
- Consist of P,M,K carbide grades and can be used in all kinds of workpiece
 - Excellent quality at machining with coolant, due to the superior thermal crack resistance of the carbide
 - Due to the special design of carbides, it has fine micro structure and low affinity with workpiece
 - It has excellent toughness and produces lower cutting loads



M type



K type

Selection system of uncoated carbide grade

Workpiece	Grade	Recommended cutting speed (m/min)	ISO	Application range
P	Steel	ST20	90 (70~110)	P20
		ST30A	80 (60~100)	P30
M	Stainless steel	U20	90 (70~110)	M20
				M30
K	Cast iron	H01, H05	150 (110~190)	K10
		G10	120 (90~150)	K20
N	Aluminum alloy	H01	600 (450~750)	N10
	Copper alloys	H05	425 (320~530)	N20

Main composition and application range

Workpiece	Composition	Features	Workpiece
P	WC-TiC-TaC-Co	Excellent thermal shock resistance and plastic deformation resistance	Carbon steel, Alloy steel, Stainless steel
M	WC-TiC-TaC-Co	General grades with thermal shock resistance and hardness	Carbon steel, Alloy steel, Stainless steel, Cast steel
K	WC-Co	High hardness and superior wear resistance	Cast iron, Non-ferrous metal, Non metal

The physical properties of uncoated carbide grades

Workpiece	Grade	Hardness (HRA)	TRS (kgf/mm ²)	Young's modulus (10 ³ kgf/mm ²)	Thermal expansion coefficient(10 ⁻⁶ /°C)	Thermal conductivity (cal/cm·sec·°C)
P	ST10	92.1	175	48	6.2	25
	ST20	91.9	200	56	5.2	45
	ST30A	91.3	230	53	5.2	-
M	U20	91.1	210	-	-	88
K	H01	92.9	210	66	4.7	109
	G10	90.9	250	63	-	105

1KPa = 102kgf/m², 1w/mk = 2.39×10⁻³cal/cm·sec·°C



Cermet grades

Features

- High hardness substrate ensures long tool life in high speed milling
- High toughness cutting edge ensures long tool life even in high impact machining
- Chemically stable substrate provides excellent surface finish of the workpiece

Selection system of cermet grades

Workpiece	Machining types	Grade	Recommended cutting speed (m/min)	ISO	Application range	
P	Steel	Continuous cutting	CN2500	250 (200~300)	P20	
		Interrupted cutting	CN30	150 (100~200)	P30	

The features of cermet grades

Cermet Grade	ISO	Features
CN2500	P20~P30	<ul style="list-style-type: none"> • Universal grade from finishing to roughing of steel • Functionally gradient material
CN30	P25~P35	<ul style="list-style-type: none"> • For milling of steel • Cermet with high toughness

The physical properties of cermet grades

Workpiece	Grade	Hardness (Hv)	TRS (kgf/mm ²)	SG (g·cm ⁻³)
P	CN2500	< 1800	210 <	6.8~7.0
	CN30	< 1500	240 <	7.0~7.3

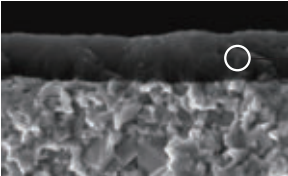


Solid endmills grade selection

PC303S / PC310U

- Ultrafine substrate & high hardness coatings for excellent wear resistance
- Special surface treatment provides higher chipping resistance

Features

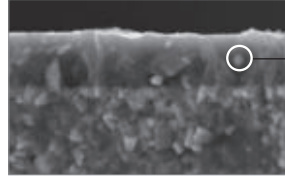


Exceptional wear resistance resulting from extremely hard coating layers

SL

- Applied high lubrication coating and special surface treatment technology

Features

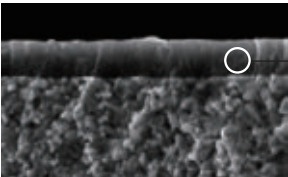


Enhanced welding resistance, chipping resistance and machining stability due to surface treatment technology

PC315E

- Fine substrate & lubricative coatings for stable machinability

Features

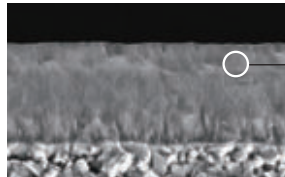


Lubricative coatings for excellent machinability

PC305H

- Enhanced wear resistance and stability from frictional heat due to high hardness substrate and high hardness coating

Features



Applied layer of AlTiSiN series

Selection system

Workpiece	Grade	ISO	Application range
P Steel	PC303S	P01	
	PC310U	P10	◀ PC303S ▶ ◀ PC203F ▶ ◀ PC305H ▶ ◀ PC310U ▶
	PC315F	P20	
	PC320	P30	◀ PC315E ▶ ◀ PC320 ▶ ◀ PC215F ▶ ◀ PC215F ▶
M Stainless steel	PC303S	M01	
	PC310U	M10	◀ PC303S ▶ ◀ PC203F ▶ ◀ PC305H ▶ ◀ PC310U ▶
	PC320S	M20	◀ PC320S ▶ ◀ PC315E ▶ ◀ PC320 ▶ ◀ PC215F ▶
	PC315E	M30	
K Cast iron	PC303S	K01	
	PC310U	K10	◀ PC303S ▶ ◀ PC203F ▶ ◀ PC305H ▶ ◀ PC310U ▶
	PC315E	K20	
	PC320	K30	◀ PC315E ▶ ◀ PC320 ▶ ◀ PC215F ▶
S HRSA	PC320S	S20	◀ PC320S ▶ ◀ PC315E ▶ ◀ PC320 ▶ ◀ PC215F ▶ ◀ SL ▶
	PC315E	S30	
N Nonferrous	ND3000 ^{new}	N01	
	ND2100 ^{new}	N05	◀ ND3000 ^{new} ▶ ◀ ND2100 ^{new} ▶ ◀ PD1005 ^{new} ▶ ◀ PD1010 ^{new} ▶ ◀ H01 ▶ ◀ H05S ▶ ◀ PC210C ▶
	PD3000	N10	
	H01	N20	
H High hardness steel	PC303S	H01	
	PC203F	H10	◀ PC303S ▶ ◀ PC203F ▶ ◀ PC305H ▶ ◀ PC310U ▶
	PC310U	H20	





Solid endmills grade

Grade information for each product

Item	Grade	
	Coated	Uncoated
H-Star Endmill	PC305H	-
V Endmill	PC215F	-
Z Endmill	PC315E	-
F Endmill	PC203F	-
T Endmill	PC2510, ND3000	H01
I+ Endmill	PC320	-
Z+ Endmill	PC320U	-
S+ Endmill	PC320S	-

Item	Carbide		HSS	
	Coated	Uncoated	Coated	Uncoated
R+ Endmill	PC10T, PC20T PC30T, PC40T	FN30T	HC10T, HC20T, HC30T	HN20T, HN30T
Aluminum Solid Endmill	PD1005, PD1010	H01	-	-
A+ Endmill	-	H05S	-	-
M+ Endmill	PC40T	-	-	-
C-Max	PC210C	-	-	-
Super Endmill	SL	-	-	-
D Endmill	ND3000	-	-	-
Composite Router Endmill	ND2100	-	-	-
Brazed Endmill	PC221F	FCC	-	-

The features of Coated grades

Workpiece	ISO	Features
PC305H	P05~P15, M05~M15, K05~K15, H05~H15	• Grade with higher Si, enhanced wear resistance and stability from frictional heat due to applying the new AlTiSiN series layer
PC315E PC320	P20~P35, K20~K35	• Excellent wear/welding resistance in high speed machining due to the combination of ultra fine substrate and PVD coating • For low/medium speed machining of general steel • New film applied with excellent chipping/wear resistance
PC320S	M20~M30, S20~S30	• Low to medium speed cutting of stainless steel and heat resistant alloys • Advanced coating layers with increased resistance to built-up edge and oxidation • Excellent resistance to wear and built-up edge at high speeds due to the ultrafine substrate and dedicated coating layers
SL	S20~S30	• Exclusive Endmill for Inconel • Coating layer with oxidation resistance and high hardness • Reducing fracture on cutting edge and enhancing wear resistance
PC210C	N10~N20	• Medium to high speed cutting of copper and copper electrode • K-Silver coating with excellent lubrication and wear and chipping resistant substrate • Medium to high speed cutting of acrylic materials
ND3000* 	N01~N05	• For electrode machining of graphite at medium to high speeds • Dia. coating layer with high wear resistance and lubrication
ND2100* 	N03~N08	• For composite materials • Diamond-coated layers with excellent adhesion
PD1005	N05~N10	• For Non-ferrous metals(Aluminum alloy) machining • DLC(Diamond Like Carbon) coating layer with high wear resistance and lubrication

* : CVD

Features of KORLOY endmills

Index	Features
H-Star Endmill (Endmill for high hardness steel)	• Carbide endmill for high hardness (HrC50~63) steel • Suitable for precision cutting due to high precision tolerance on radius and tool diameter
Z Endmill / I+ Endmill (Endmill for general cutting)	• Excellent in machining various workpieces such as carbon steel, alloy steel, cast iron, pre hardened steel, etc. under HRC45 • Longer tool life with the use of ultra fine substrate and new coating technology
T Endmill (For dental purpose)	• Endmill for dental prostheses made of zirconia, titanium, Co-Cr, wax, PMMA, and glass ceramic • Custom-made tools for each type of milling machines for dental purpose
Z+ Endmill	• Universal endmill applicable to a variety of workpiece materials under HrC47 • Roughing and finishing availability • Improved tool life thanks to the new substrate and the most advanced coating • Inhibited chipping and longer cutting time due to the optimized blade design
SSEA / A+ Endmill (Endmill for aluminum)	• Suitable for high speed machining in aluminum and other Non-ferrous materials • Can accomplish excellent surface finishing, superior chip removal in high feed rate
M+ Endmill (Multi-functional endmill)	• Various cutting with one Endmill: Drilling, Ramping, Slotting and Side Milling • Reducing cutting resistance and enhancing surface finish due to high tool rigidity
S+ Endmill (Endmill for hard-to-cut materials)	• Sharp cutting edge and high rake angle with streamline chip pocket shows good cutting performance in stainless steel machining where work hardening is a problem
R+ Endmill	• High efficient roughing endmill for medium to rough cutting • Excellent machining efficiency thanks to the high efficient roughing edge design • Reduced cutting force thanks to specifically designed corners, and irregular flute spacing and lead angle
D Endmill	• Diamond-coated endmill for graphite and ceramic • Excellent wear resistance thanks to the diamond coating of high hardness and high purity • Optimized for high speed and heavy duty cutting thanks to the strong grip of coating • Excellent cutting performance and finish thanks to the optimized blade design of high rake
Composite Router Endmill	• Router endmill for machining composite materials (CFRP & GFRP) • Minimized machining defects thanks to its design to prevent flaking, peeling off and burrs • Excellent resistance to wear and flaking thanks to the nano-crystalline diamond coating of high hardness and high purity
C-Max	• Ideally suited for machining copper, brass, bronze, and Non-ferrous materials thanks to the optimized combination between K-Silver coating with excellent lubrication and resistance to wear and chipping, and the dedicated substrate
Super Endmill	• High lubricated coating and special surface treatment • Improved welding and chipping resistance and machining stability due to surface treatment technology



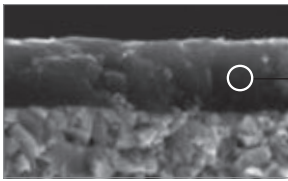
Solid drills grades selection

Grades for Mach Solid Drill (MSD)

PC325U

- Special surface treatment provides improved lubrication and reduced cutting loads
- Stable tool life thanks to increased welding resistance

Features



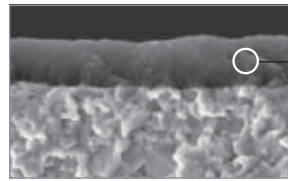
Increased welding resistance in medium to high speed cutting due to highly lubricative coating layers
Increased wear resistance in carbon steel machining

Grades for Mach Solid Drill (MSD)

PC325T ^{new}

- Good wear resistance in HRSA machining at high temperature
- Good surface finish reduces friction resistance and increases chip evacuation

Features



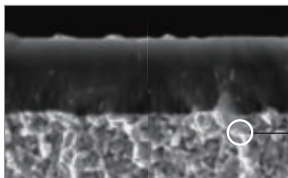
High heat and oxide resistance increase tool life
Increased wear.
Good surface finish coating layer ensures lubrication and high quality in machining.

Grades for Mach Long Drill (MLD)

PC215G / PC315G

- Improved wear resistance due to the ultrafine substrate
- Reduced friction resistance and smooth chip flow due to improved coating lubrication

Features



Exceptional wear resistance due to the ultrafine substrate

Selection system

Workpiece	Grade	ISO	Application range			
P Steel	PC215G	P01				
	PC315G	P10				
	PC325U	P20	PC215G	PC315G	PC325U	PC230F
	PC230F	P30				
M Stainless steel	PC215G	M01				
	PC315G	M10				
	PC205F	M20	PC215G	PC315G	PC325U	
	PC325U	M30				
K Cast iron	PC215G	K01				
	PC315G	K10				
	PC205F	K20	PC215G	PC315G	PC325U	
	PC325U	K30				
N Nonferrous	ND2100 ^{new}	N05	ND2100 ^{new}			
	FG2	N10		FG2	FA1	
	FA1	N20				
S HRSA	PC325T ^{new}	S20	PC325T ^{new}			
		S30				



Solid drills grades

Grade information for each product

Item	Grade	
	Coated	Uncoated
MSD Plus	PC325U	FG2
MSD Plus-S	PC325T	-
MSD Plus CFRP	ND2100	-
MSFD	PC325U	-
MLD Plus	PC215G, PC315G	FG2
VZD	PC230F	-
ESD Plus	PC325U	FG2
SSD Plus	-	FA1, FG2

The features of PVD coated grades

Workpiece	ISO	Features
PC325U	P20~P35 M20~M30 K20~K35	<ul style="list-style-type: none"> • Universal grade for machining steel, cast iron, stainless steel, etc. • Stable cutting performance with excellent wear/chipping resistance • Increased welding resistance due to lubricative new coating at medium to high speed
PC325T ^{new}	M20~M30 S20~S30	<ul style="list-style-type: none"> • Good wear resistance realizes HRSA machining at high temperature • Good wear and chipping resistance ensure stable machinability
PC215G	P15~P30 M15~M25 K15~K30	<ul style="list-style-type: none"> • Universal grade for machining steel, cast iron, etc. • Stable cutting performance with excellent wear/chipping resistance
PC315G	P15~P30 M15~M25 K15~K30	<ul style="list-style-type: none"> • Universal grade for machining steel, cast iron, stainless steel, etc. • Stable cutting performance with excellent wear/chipping resistance • Increased welding resistance due to lubricative new coating at medium to high speed
PC230F	P25~P35	<ul style="list-style-type: none"> • For machining general steel at medium to high speed • Stable cutting performance with excellent wear/chipping resistance
ND2100 ^{new}	N05~N10	<ul style="list-style-type: none"> • For machining composite materials • Diamond-coated layers with excellent adhesion
FG2 / FA1	N05~N25	<ul style="list-style-type: none"> • Increased wear/chipping resistance with the use of ultra fine substrate

Features of KORLOY drills

Index	Features
MSD Plus	<ul style="list-style-type: none"> • Increased welding resistance in medium to high speed cutting due to highly lubricative coating layers • Increased wear resistance in carbon steel machining • Reduced friction resistance around corners and flutes
MSD Plus-S	<ul style="list-style-type: none"> • Exclusive for HRSA grooving with good wear resistance at high temperature and chipping resistance. • New coating layer with good surface finish reduces frictional resistance and increases chip evacuation. • Preventing chipping on the cutting edge and fracture of tool ensures high productivity.
MSD Plus CFRP	<ul style="list-style-type: none"> • The best tool for hole making of CFRP workpieces • Excellent wear resistance due to the diamond-coated grade • Reduced burr creation in CFRP machining due to high rake cutting edges
MSFD	<ul style="list-style-type: none"> • High quality hole making capability with 180° point angle • Improved anti-chipping and welding resistance by edge honing and chamfering • Minimized creation of burrs compared to general drills
MLD Plus	<ul style="list-style-type: none"> • Higher rigidity due to straight-edge design • Smooth chip flow due to wider chip pockets and improved surface finish on flutes • Double margin system for stable machinability
ESD Plus	<ul style="list-style-type: none"> • Lubricative coating layer improves welding resistance at middle to high speed. • Increase wear resistance in machining carbon steel • Increased welding resistance and wear resistance with new PC325U grade applied.
SSD Plus	<ul style="list-style-type: none"> • New shape increases chip control • Surface finish and improved shape realize high quality of machining • Stable tool life increases productivity



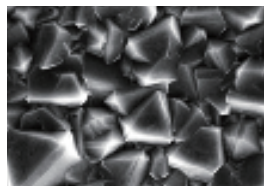
Diamond coated grades

Grade for graphite and ceramic

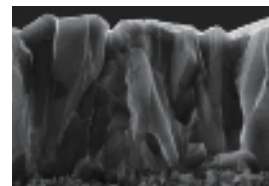
ND3000 new

- SP3-crystalline diamond coatings of high purity and high hardness
- Improved adhesion between coated layers and the substrate that is specialized for diamond coatings
- Excellent tool life when machining graphite and ceramic

Surface of ND3000



Cross section of ND3000's coated layers

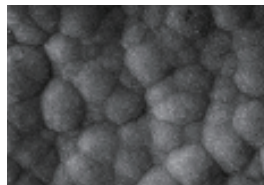


Grade for composite materials

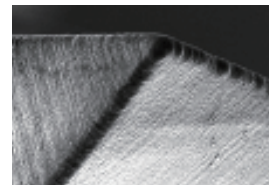
ND2100 new

- Improved surface finish and wear resistance due to the control technology of nano-crystalline diamond particles
- Improved flaking resistance due to the substrate that is specialized for diamond coatings
- High quality and high precision machining availability thanks to sharp edges
- Excellent tool life when machining composite materials

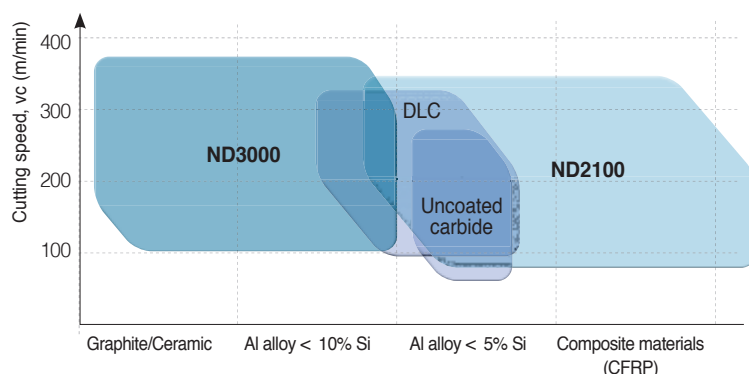
Surface of ND2100



Sharp edges of ND2100



Application range



Selection system

Workpiece		Grade	ISO	Application range	
N Nonferrous	Graphite/Ceramic	ND3000 <small>new</small>	N01	ND3000 <small>new</small>	
	Al alloy	ND3000 <small>new</small> ND2100 <small>new</small>	N05	ND3000 <small>new</small>	ND2100 <small>new</small>
	Composite materials	ND2100 <small>new</small>	N10	ND2100 <small>new</small>	

The features of diamond coated grades

Grade	ISO	Features
ND3000 <small>new</small>	N01~N05	<ul style="list-style-type: none"> • For continuous roughing of graphite, ceramic, and Al alloy at high speeds • Exceptional cutting performance due to high resistance to wear and flaking • High hardness diamond coatings of high purity SP3-crystalline structure
ND2100 <small>new</small>	N05~N10	<ul style="list-style-type: none"> • For continuous finishing of composite materials and Al alloy at high speeds • Stable machinability due to durable sharp edges • Nano-crystalline diamond coatings under particle control



DLC coated grades

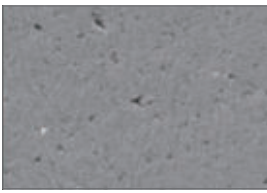
DLC-Coated Inserts for Non-Ferrous Metals

PD1005 ^{new} / PD1010 ^{new}

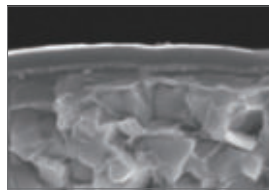
- High hardness and low friction DLC coating technology
- Lubrication and maximized wear resistance increases machinability and machining quality.
- Optimal substrate for each workpiece ensures stable and long tool life
- For non-ferrous metals such as aluminum, Al-Si alloy, copper and etc. machining

Features

Smooth coating surface

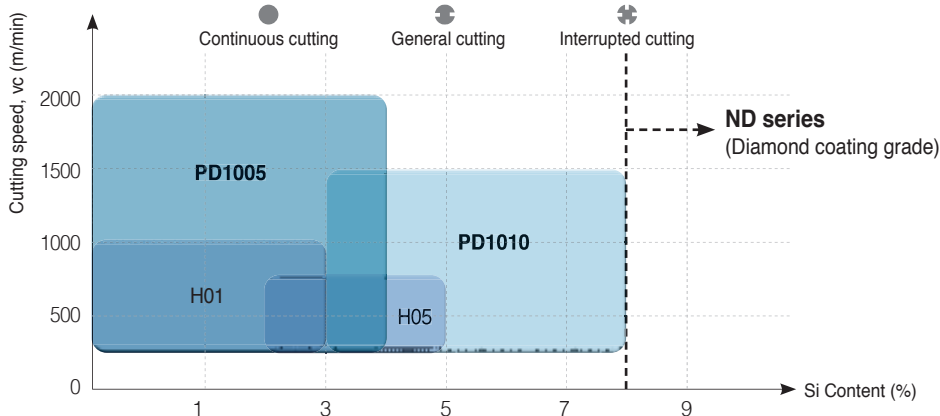


Hard DLC coating



Grade	Wear resistance and Welding resistance	Surface finish	Chip curl
Carbide non coated			
DLC PD1010			

Application range



Selection system

Workpiece		Grade	ISO	Application range	
N	Non-ferrous metals	Aluminum and copper (Soft non-ferrous metals)	PD1005	N05	
		Aluminum alloy	PD1005 PD1010	N10	
		Al-Si alloy (Hardened non-ferrous metals)	PD1010	N15	

The features of DLC coating grades

Grade	ISO	Features
PD1005 ^{new}	N05	<ul style="list-style-type: none"> • For high speed and continuous machining of Aluminum and copper • High wear and welding resistance realize good machinability • High performance of DLC coating with high hardness and low friction
PD1010 ^{new}	N10	<ul style="list-style-type: none"> • For medium to high and interrupted machining of aluminum alloy and Al-Si alloy • Stable tool life due to substrate with chipping resistance • High performance DLC coating with high hardness and low friction



cBN inserts grades

- Features**
- Excellent hardness and thermal resistance by sintering KORLOY's main constituents and special ceramic binder at high pressure and high temperature
 - Excellent hardness and wear resistance for higher productivity in machining cast iron and heat-treated alloy at high speed

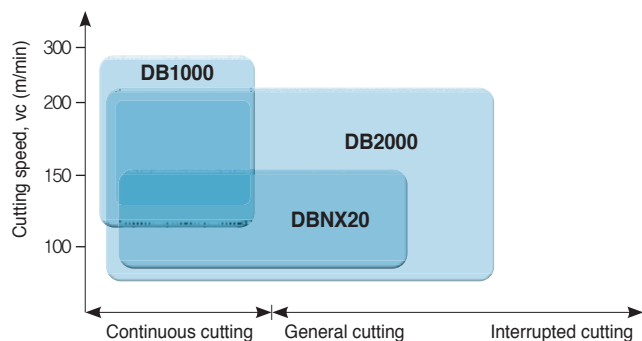
► Insert type

High precision		Wear resistance		Productivity	
For regrinding type	One use type	Multi-corner type	Multi-corner type (coated)	Solid type	Grooving type

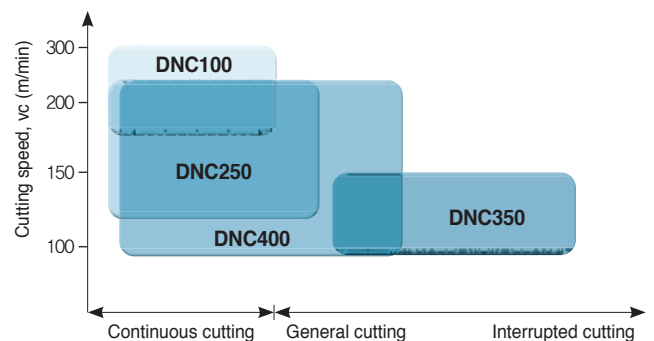
cBN inserts

Multi edge coated type		One use type	
<ul style="list-style-type: none"> • Easy handling of corners • Strong Brazing • Excellent tool life compared to non-coated inserts 	2NU-CNGA120408	<ul style="list-style-type: none"> • Economic price • Easy handling of tools • A wide variety of series • Smaller than expensive cBN and dramatic cost down • Strong weld face and stable cutting performance 	NU-CNGA120408
Multi edge type		Regrinding type	
<ul style="list-style-type: none"> • Price per edge is more reasonable compare to normal single cornered, one-used type • Insert with several brazed cBN • Wide application of continuous to interrupted machining 	2NU-CNGA120408	<ul style="list-style-type: none"> • Long tool life • Excellent wear resistance, High hardness • Saved tool cost due to the regrinding insert 3~4 time 	CNMA120408














cBN application range



Coated cBN application range



➤ Cutting condition of cBN grades

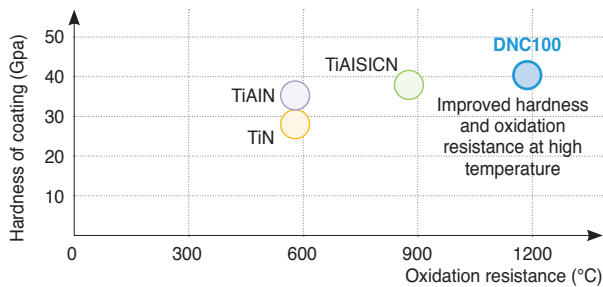
Workpiece	Grades	Insert color	Application	Cutting speed, vc (m/min)	Feed, fn (mm/rev)	Depth of cut, ap (mm)	
H High hardness steel	Coated	DNC100	Continuous cutting at high speed	180  300	0.03~0.3	0.03~0.3	
		DNC250	Continuous and low interrupted cutting at high speed	120  220	0.05~0.3	0.05~0.3	
		DNC300	Medium and low interrupted cutting	90  250	0.05~0.2	0.05~0.2	
		DNC350	Medium and high interrupted cutting	90  150	0.05~0.3	0.05~0.3	
		DNC400	Continuous and medium interrupted cutting	90  220	0.05~0.3	0.05~0.5	
	Non coated	DB1000		Continuous cutting at high speed	130  250	0.03~0.15	0.03~0.2
		DB2000		Medium and low interrupted cutting	80  200	0.03~0.2	0.03~0.3
		DBNX20		Highly efficient cutting	120  150	0.03~0.3	0.03~0.5
		DBN250		Medium and low interrupted cutting	80  120	0.03~0.2	0.03~0.3
		DBN350		High interrupted cutting	120  220	0.03~0.2	0.03~0.3
S HRSA	DB7000		Continuous cutting at high speed	100  300	0.05~0.2	0.1~1.0	
K Cast iron	DBN700A		Continuous cutting at high speed	500  2000	0.10~0.4	0.1~0.4	

Coated cBN

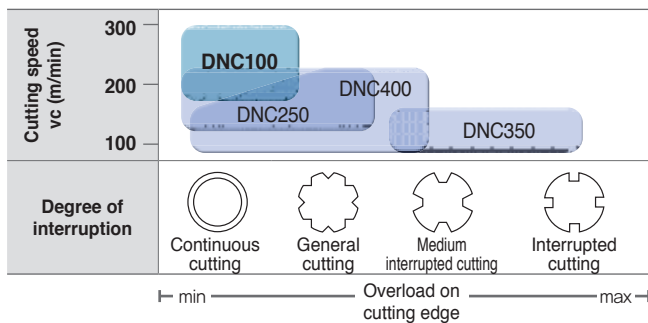
DNC100

➤ Features




- Excellent thermal resistance
- Coating layer with high hardness, oxidation resistance and chipping resistance



➤ Application range



➤ Recommended cutting condition

Cutting speed vc (m/min)	180  300
Feed fn (mm/rev)	0.03  0.3
Depth of cut per time ap (mm)	0.03  0.3

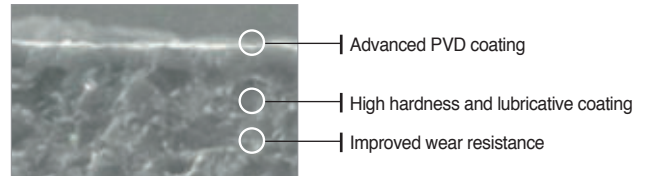
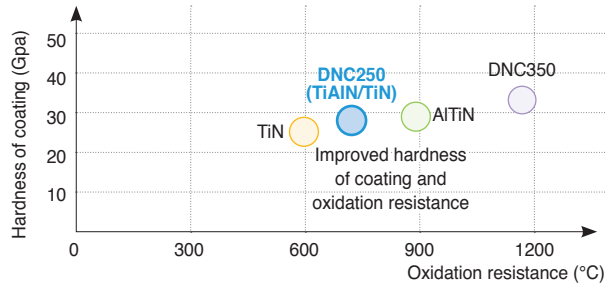
- Increased oxidation resistance and wear resistance due to high hardness coating layer
- Dramatically improved fracture resistance and chipping resistance



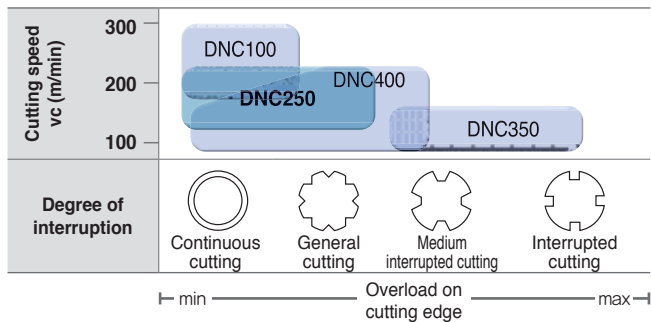
Multi-corner coated cBN for high efficient cutting of heat-treated alloy

DNC250

- Features**
- Stable and long tool life
 - Cost effective by multi-cornered one-use insert



Application range



Recommended cutting condition

Cutting speed vc (m/min)	120 ————— 220
Feed fn (mm/rev)	0.05 ————— 0.3
Depth of cut per time ap (mm)	0.05 ————— 0.3

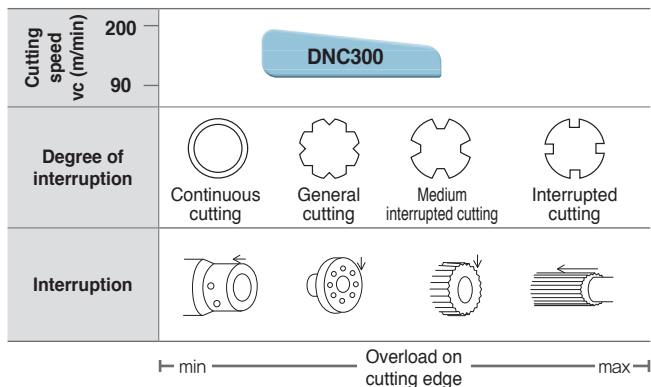
Coated cBN

DNC300

- Features**
- 1st recommended grade for low to medium interrupted cutting
 - Enhanced chipping resistance and wear resistance comparing to competitor's grade
 - Minimizing flaking of coating by stable coating



Application range



Recommended cutting condition

Cutting speed vc (m/min)	90 ————— 200
Feed fn (mm/rev)	0.05 ————— 0.3
Depth of cut per time ap (mm)	0.05 ————— 0.25

- Enhanced oxidation resistance and wear resistance due to high hardness layer
- Highly increased chipping resistance, fracture resistance and wear resistance

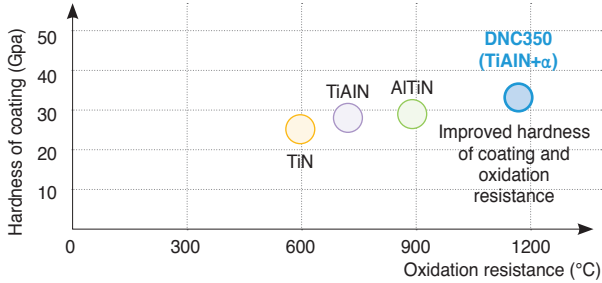


Coated cBN for high interrupted cutting

DNC350

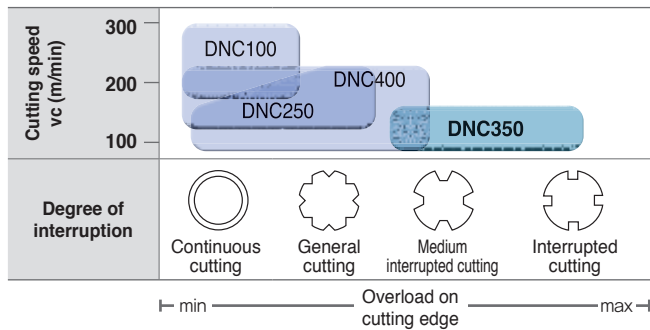
Features

- Excellent tool life and productivity in interrupted cutting
- New PVD coating applied with high hardness and oxidation resistance



- High hardness and oxidation-resistant coating
- High tough coating
- Fine cBN + High tough substrate

Application range



Recommended cutting condition

Cutting speed v_c (m/min)	90 — 150
Feed f_n (mm/rev)	0.05 — 0.3
Depth of cut per time a_p (mm)	0.05 — 0.3

Solid type coated cBN

DNC400 new

Features

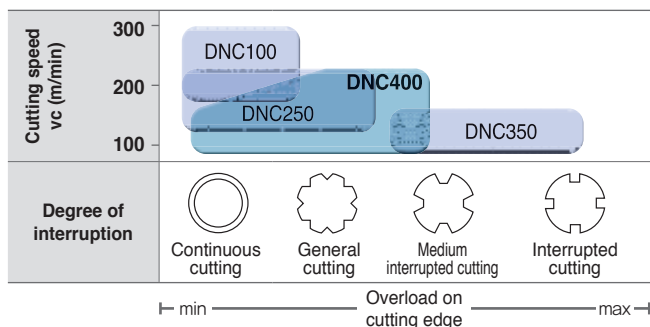
- For machining heat-treated steel in continuous and medium interrupted cutting
- Longer tool life due to coating layer
- Solid type for universal purpose

Features of solid type cBN

- Increased productivity at high speed and high depth of cut
- Ideal for removing cemented layer and the welds
- Better welding stability due to 3-face blazing
- Excellent cutting performance at varying depth of cuts



Application range



Recommended cutting condition

Feed f_n (mm/rev)	DNC400	0.05 — 0.3
	DNC250	0.05 — 0.3
	DNC350	0.05 — 0.3
Depth of cut per time a_p (mm)	DNC400	0.05 — 0.5
	DNC250	0.05 — 0.3
	DNC350	0.05 — 0.3



Non-coated cBN

DB1000

Features

- Non-coated cBN with the highest wear resistance at high speed
- Excellent tool life in continuous to light interrupted cutting
- Improved fracture resistance along with high wear resistance
 - Higher thermal resistance and hardness due to pure TiCN ceramic binder



Non-coated cBN

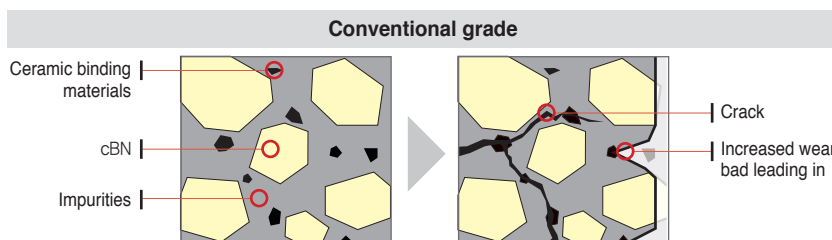
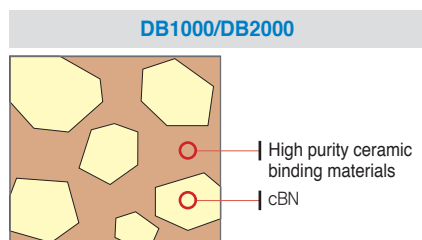
DB2000

Features

- Universal grade for overall machining of heat-treated
 - Stable tool life in continuous to low/medium interrupted cutting
- Both fracture resistance and wear resistance acquired with the use of pure ceramic binder
- Stable surface roughness



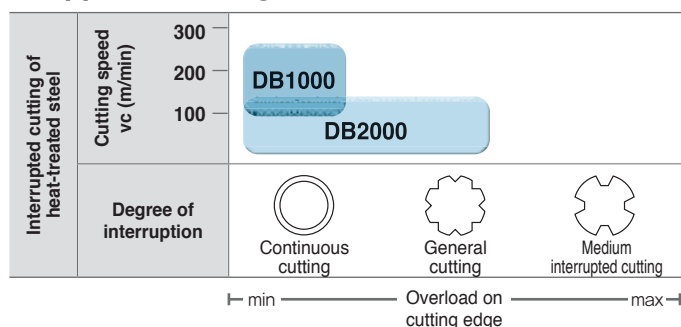
New technology of high purity ceramic binding materials



DB2000 dramatically minimizes impurities with the use of high purity ceramic binding materials and enhances thermal resistance and toughness.

Impurities included in conventional grade's ceramic binder caused inferior thermal resistance and hardness of sintered compounds, which led to crack (fracture) and wear

Application range



Recommended cutting condition (DB1000)

Cutting speed vc (m/min)	130 ————— 250
Feed fn (mm/rev)	0.03 ————— 0.15
Depth of cut ap (mm)	0.03 ————— 0.2

Recommended cutting condition (DB2000)

Cutting speed vc (m/min)	80 ————— 200
Feed fn (mm/rev)	0.03 ————— 0.2
Depth of cut ap (mm)	0.03 ————— 0.3



PCD inserts grades

Features

KORLOY PCD products are manufactured by using high quality PCD tips under ultra high temperatures and pressure. The PCD tip is welded on the qualified KORLOY carbide insert
KORLOY high quality PCD products meet a wide range of application needs in turning, milling, and endmills.

- Excellent tool life for aluminum alloy and copper alloy
- Excellent tool life for Ceramic, high-silicon aluminum and rock or stone
- Excellent tool life for rubber, carbon, graphite and wood

PCD grade

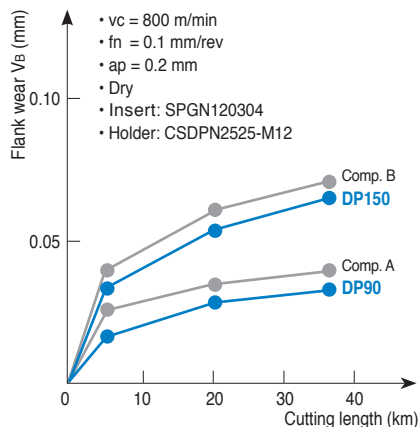
Grade	Features	Application	Grain size (μm)	Hardness (Hv)	TRS (kgf/mm ²)
DP90	Coarse diamond grain has been used to get excellent wear resistance enough to machine cemented-carbide, high Si aluminum alloy	Cemented carbide Ceramic roughing High Si aluminum alloy Rock, Stone	25~30	50~65	≒ 1.10
DP150	By use of fine diamond grain having good bonding property, it is suitable for machining of Non-ferrous metal, graphite	High Si aluminum alloy Copper, Bronze alloy Rubber, Wood, Carbon	5~10	50~60	≒ 1.95
DP200	By use of ultra fine diamond grain, it is possible to make sharp cutting edge. Thus it is appropriate grade to machine Non-ferrous material	Plastic Wood Precise finishing of aluminum	~2	45~55	≒ 2.45

Recommended cutting condition

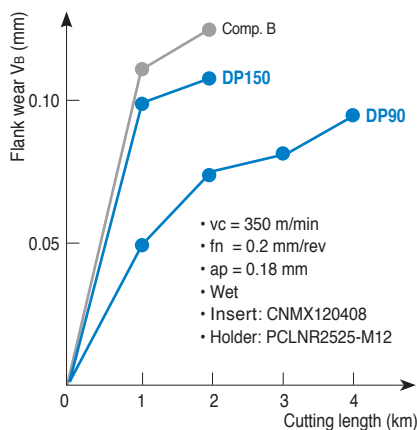
Workpiece	Cutting speed (m/min)	Feed (mm/rev)	Depth of cut (mm)	Recommended grade	
				1 st	2 nd
Aluminum alloy (4%~8% Si)	1000~3000	0.1~0.6	~3	DP150	DP200
Aluminum alloy (9%~14% Si)	600~2500	0.1~0.5	~3	DP150	DP200
Aluminum alloy (15%~18% Si)	300~700	0.1~0.4	~3	DP150	DP200
Copper, Bronze alloy	~1000	0.05~0.2	~3	DP150	DP200
Reinforced plastic	~1000	0.1~0.3	~2	DP150	DP200
Wood	~4000	0.1~0.4	-	DP150	DP200
Cemented carbide	10~30	~0.2	~0.5	DP90	DP150

Cutting performance

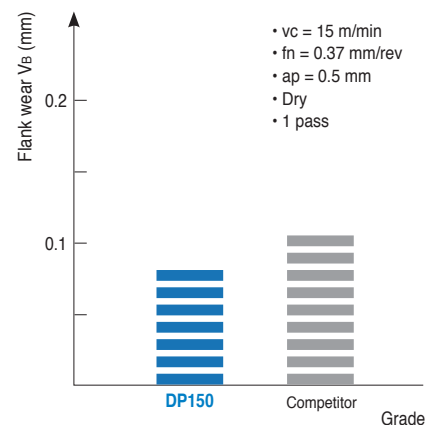
Continuous cutting test (Workpiece: Al-25%Si)



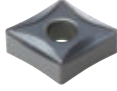
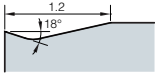
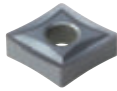
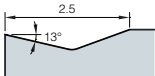
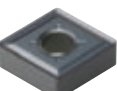
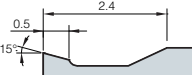

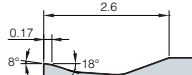

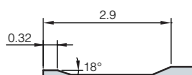

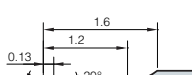

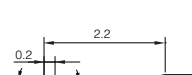

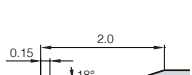
Interrupted cutting test (Workpiece: Al-20%Si)



Cutting test of cemented carbide




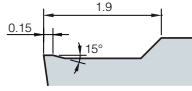

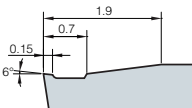

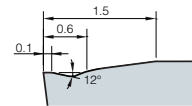

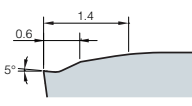
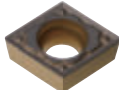
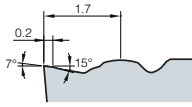
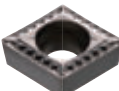
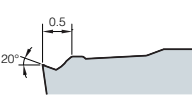
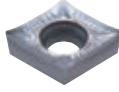
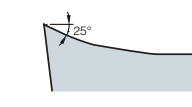
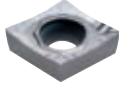
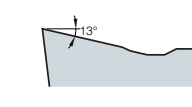
Chip breaker for turning

Geometry	Cutting edge	Application range											Features											
		feed rate f_n (mm/rev)																						
		0.04	0.063	0.10	0.16	0.25	0.4	0.63	1.0	1.6	2.5	4.0		6.3										
depth of cut ap (mm)																								
											0.1	0.16	0.25	0.4	0.63	1.0	1.6	2.5	4.0	6.3	10.0	11.6	13	
V series	VP1																							For Finishing <ul style="list-style-type: none"> High positive cutting edge Reduced contract chip minimizes temperature to improve tool life
	VP2																							For Medium to finish cutting <ul style="list-style-type: none"> Stable chip control and high machinability in copying with various depths of cut
	VP3																							For Medium cutting <ul style="list-style-type: none"> High positive cutting edge with wide land Stable cutting performance in interrupted machining with high toughness Stable machinability and chip control in machining with high depth of cut
	VP4																							For Roughing <ul style="list-style-type: none"> The first recommended chip breaker for inconel cutting High hard and resistant rake angle to prevent notch wear in roughing of rugged surfaces
	VR																							For Roughing <ul style="list-style-type: none"> High feed machining with the combination of wide land and pockets Shallow chip breaker design prevents chip blocking at high feed Decreased wear on major cutting edge due to special treatment on blade
-P series	LP																						For Medium to finish cutting <ul style="list-style-type: none"> Angle land decreases cutting resistance for better surface roughness Special dot design prevents chip blocking by clear chip breaking 	
	MP																						For Medium cutting <ul style="list-style-type: none"> Increased productivity due to excellent chip control in various conditions Stable tool life by reducing cutting load at high speed and high feed 	
	CP																						For Medium to finish cutting <ul style="list-style-type: none"> Chip breaker with strong cutting edge in high interrupted finishing and medium cutting Effective chip control in low depth of cut to high depth of cut due to 2-step rear angle 	

Notice: Application ranges are based on main cutting material



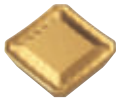















Chip breaker for turning

Geometry	Cutting edge	Application range													Features
		feed rate f_n (mm/rev)													
		0.04	0.063	0.10	0.16	0.25	0.4	0.63	1.0	1.6	2.5	4.0	6.3		
		depth of cut a_p (mm)													
		0.1	0.16	0.25	0.4	0.63	1.0	1.6	2.5	4.0	6.3	10.0	11.6	13	
C-Posi series	C25						0.10~0.35			1.0~3.0					For Roughing <ul style="list-style-type: none"> Suitable for interrupted cutting and cast iron machining Good surface finish due to low cutting force Suitable for both boring and outer diameter turning
	HMP						0.08~0.40			0.5~3.5					For Medium cutting <ul style="list-style-type: none"> Excellent chip control at wide range of cutting conditions Machining versatility over a wide range of materials
V-Posi series	VF						0.05~0.25			0.1~1.5					For Finishing <ul style="list-style-type: none"> Improved surface finish and size accuracy due to stable inner boring
	VL						0.05~0.20			0.1~1.0					For Finishing <ul style="list-style-type: none"> Superior chip control in low carbon steel, pipes, and steel plates
P-Posi series	MP						0.05~0.30			0.3~3.0					For Medium cutting <ul style="list-style-type: none"> Sharp cutting edge and wide chip pocket for low cutting load Stable chip control at varying depth of cuts Excellent cutting performance when machining automobile components
AL series	FP						0.01~0.20			0.1~1.0					For Finishing <ul style="list-style-type: none"> For chip control in low depth of cut mild cutting Enhanced surface finish and reduced cutting load
	AK						0.03~0.40			0.1~4.0					For Medium to finish cutting <ul style="list-style-type: none"> Exclusive chip breaker for aluminum and aluminum alloy cutting
	AR						0.05~0.50			0.5~4.0					For Medium to finish cutting <ul style="list-style-type: none"> High stability of cutting edge secures great performance in high speed and interrupted machining High speed of medium and interrupted operation

Notice: Application ranges are based on main cutting material









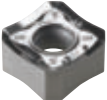
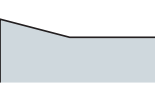





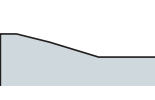


Chip breaker for milling

Geometry	Cutting edge	Application range																Features	
		feed rate f_n (mm/rev)																	
		0.05	0.10	0.15	0.20	0.25	0.30	0.35	0.40	0.80	1.20	1.40	1.60						
		depth of cut ap (mm)																	
		0.1	0.5	1	2	3	4	5	6	8	10	15	20						
MX series	MX																		For Roughing <ul style="list-style-type: none"> Possible to increase productivity through increase feed and depth Excellent heat resistance due to the special chip breaker design of top face of insert
																		0.10~0.30 1.0~5.0	
Mill-max Heavy	MM																		For Roughing <ul style="list-style-type: none"> Specialized tool for high depth of cut roughing with high rigidity cutting edge ensures stable machining.
																		0.20~0.40 2.0~14.0	
Rich Mill series-RM3	MA																		For Aluminum machining <ul style="list-style-type: none"> Sharp cutting edge for low cutting load, which is ideal for machining steel, hard-to-cut materials and aluminum
																		0.05~0.40 1.0~8.0	
	ML																		For machining hard-to-cut materials <ul style="list-style-type: none"> Low cutting resistance for light cutting and machining hard-to-cut materials with excellent tool life and surface roughness
																		0.05~0.30 1.0~8.0	
Rich Mill series-RM3	MM																		For General cutting <ul style="list-style-type: none"> Available for most of applications with universal design for general milling
																		0.05~0.35 1.0~8.0	
Rich Mill series-RM4	MA																		For Aluminum machining <ul style="list-style-type: none"> Sharp cutting edge design ensures low cutting resistance and excellent machining in difficult-to-cut materials, aluminum and light machining
																		0.05~0.25 0.3~14.0	
	MF																		For Light cutting <ul style="list-style-type: none"> Low cutting force chip breaker design ensures longer tool life and excellent machining in difficult-to-cut material and light machining
																		0.05~0.30 0.5~14.0	
Rich Mill series-RM4	MM																		For General cutting <ul style="list-style-type: none"> Suitable geometry design for general milling has wider ranges of machining
																		0.05~0.30 1.0~14.0	

Notice: Application ranges are based on main cutting material






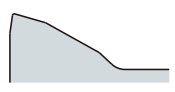

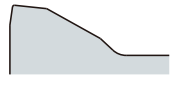

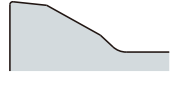



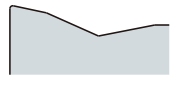




Chip breaker for milling

Geometry	Cutting edge	Application range														Features								
		feed rate f_n (mm/rev)																						
		0.05	0.10	0.15	0.20	0.25	0.30	0.35	0.40	0.80	1.20	1.40	1.60											
depth of cut a_p (mm)																								
0.1														0.5	1	2	3	4	5	6	8	10	15	20
Rich Mill series-RMG	MA			<div style="display: flex; justify-content: space-between;"> 0.05~0.20 1.0~8.2 </div>														For Aluminum machining <ul style="list-style-type: none"> Specialized sharp cutting edge for aluminum machining ensures machinability. Buffing treatment on the surface realizes good chip flow and welding resistance. 						
	ML			<div style="display: flex; justify-content: space-between;"> 0.05~0.25 1.0~8.2 </div>														For Machining hard-to-cut materials <ul style="list-style-type: none"> Low cutting load chip breaker for light cutting Long tool life and high quality of machining in hard-to-cut material cutting 						
	MM			<div style="display: flex; justify-content: space-between;"> 0.05~0.25 1.0~8.2 </div>														For General cutting <ul style="list-style-type: none"> Optimally designed shape for general shoulder milling in various cutting ranges 						
Rich Mill series-FM8	MA			<div style="display: flex; justify-content: space-between;"> 0.05~0.35 0.3~6.0 </div>														For Aluminum machining <ul style="list-style-type: none"> Sharp cutting edge and lubricated top face show excellent chip flow and welding resistance in aluminum machining 						
	MF			<div style="display: flex; justify-content: space-between;"> 0.05~0.35 0.3~6.0 </div>														For Light cutting <ul style="list-style-type: none"> Low cutting force chip breaker design ensures longer tool life and excellent machining in difficult-to-cut material and light machining 						
	ML			<div style="display: flex; justify-content: space-between;"> 0.05~0.30 0.3~6.0 </div>														For Machining hard-to-cut materials <ul style="list-style-type: none"> Chip breaker with low cutting load resistance ensures long tool life and high quality in light and hard-to-cut material cutting. 						
	MM			<div style="display: flex; justify-content: space-between;"> 0.10~0.40 0.5~6.0 </div>														For General cutting <ul style="list-style-type: none"> Suitable geometry design for general milling has wider ranges of machining 						
Rich Mill series-RMT8	MF			<div style="display: flex; justify-content: space-between;"> 0.05~0.20 0.5~5.0 </div>														For Light cutting <ul style="list-style-type: none"> Low cutting force chip breaker design ensures longer tool life and excellent machining in difficult-to-cut material and light machining 						

Notice: Application ranges are based on main cutting material



















Chip breaker for milling

Geometry	Cutting edge	Application range																Features								
		feed rate f_n (mm/rev)																								
		0.05	0.10	0.15	0.20	0.25	0.30	0.35	0.40	0.80	1.20	1.40	1.60													
depth of cut a_p (mm)																										
0.1																0.5	1	2	3	4	5	6	8	10	15	20
Rich Mill series-RMT8	MM			0.05~0.30																For General cutting • Suitable geometry design for general milling has wider ranges of machining						
				0.5~8.0																						
Rich Mill series-RM8-X	ML			0.05~0.30																For Machining hard-to-cut materials • Stable tool life and good cutting quality in hard-to-cut material cutting due to double reverse positive relief surface and low cutting load chip breaker						
				1.0~3.0																						
Rich Mill series-RM8-X	MM			0.05~0.30																For high hardness cutting • Stable tool life and good cutting quality due to double reverse positive relief surface and high rigidity chip breaker						
				1.0~3.0																						
Rich Mill series-RM8-X	MM			0.10~0.30																For General cutting • For general cutting range with optimal shape for general milling						
				1.0~3.0																						
Rich Mill series-RM14	ML			0.05~0.30																For HRSA cutting • Excellent cutting performance in heat resistance STS cutting from neutral type flat cutting edge and sharp chip breaker						
				1.0~3.0																						
Rich Mill series-RM14	ML			0.05~0.30																For cast iron and STS cutting • Excellent cutting performance in general STS and cast iron cutting from right-handed helix cutting edge and sharp chip breaker						
				1.0~3.0																						
Rich Mill series-RM16	MA			0.05~0.30																For Aluminum machining • Sharp cutting edge design ensures low cutting resistance and excellent machining in difficult-to-cut materials, aluminum and light machining						
				0.3~5.5																						
Rich Mill series-RM16	MF			0.05~0.40																For Light cutting • Low cutting force chip breaker design ensures longer tool life and excellent machining in difficult-to-cut material and light machining						
				0.3~5.5																						

Notice: Application ranges are based on main cutting material












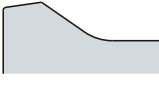






Chip breaker for milling

Geometry	Cutting edge	Application range																Features		
		feed rate f_n (mm/rev)																		
		0.05	0.10	0.15	0.20	0.25	0.30	0.35	0.40	0.80	1.20	1.40	1.60	depth of cut a_p (mm)						
				0.1	0.5	1	2	3	4	5	6	8	10	15	20					
Rich Mill series-FM16	ML			<div style="background-color: #ADD8E6; padding: 2px;">0.05~0.35</div> <div style="background-color: #90EE90; padding: 2px;">0.3~5.5</div>																For Machining hard-to-cut materials • Low cutting resistance for excellent tool life and surface roughness in machining hard-to-cut materials
	MM			<div style="background-color: #ADD8E6; padding: 2px;">0.10~0.45</div> <div style="background-color: #90EE90; padding: 2px;">0.5~5.5</div>																For General cutting • Suitable geometry design for general milling has wider ranges of machining
	W			<div style="background-color: #ADD8E6; padding: 2px;">0.05~0.30</div> <div style="background-color: #90EE90; padding: 2px;">0.3~2.0</div>																For Finishing of milling (Wiper) • Wiper insert provides improved surface roughness due to special cutting edge
Rich Mill series-RMR	ML			<div style="background-color: #ADD8E6; padding: 2px;">0.05~0.40</div> <div style="background-color: #90EE90; padding: 2px;">1.0~3.0</div>																For Machining hard-to-cut materials • Stable tool life and cutting performance in hard-to-cut material cutting from hard clamping side preventing reverse positive revolution and low cutting resistance chip breaker
Alpha Mill series	MA			<div style="background-color: #ADD8E6; padding: 2px;">0.10~0.40</div> <div style="background-color: #90EE90; padding: 2px;">0.5~16</div>																For Aluminum machining • Sharp cutting edge and lubricated top face show excellent chip flow and welding resistance in aluminum machining
	MF			<div style="background-color: #ADD8E6; padding: 2px;">0.05~0.15</div> <div style="background-color: #90EE90; padding: 2px;">0.5~16</div>																For Light cutting • Low cutting force chip breaker design ensures longer tool life and excellent machining in difficult-to-cut material and light machining
	MM			<div style="background-color: #ADD8E6; padding: 2px;">0.10~0.25</div> <div style="background-color: #90EE90; padding: 2px;">0.5~16</div>																For General cutting • Suitable geometry design for general milling has wider ranges of machining
	ML			<div style="background-color: #ADD8E6; padding: 2px;">0.05~0.15</div> <div style="background-color: #90EE90; padding: 2px;">0.5~16</div>																For Hard-to-cut material machining • The chip breaker with low cutting resistance ensures superior machinability in hard-to-cut materials

Notice: Application ranges are based on main cutting material



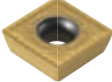







Chip breaker for milling

Geometry	Cutting edge	Application range																Features	
		feed rate f_n (mm/rev)																	
		0.05	0.10	0.15	0.20	0.25	0.30	0.35	0.40	0.80	1.20	1.40	1.60	depth of cut a_p (mm)					
				0.1	0.5	1	2	3	4	5	6	8	10	15	20				
Future Mill series P-posi	ML																0.3~3.0	0.30~0.50	For Hard-to-cut material machining <ul style="list-style-type: none"> Low cutting resistance and high hardness cutting edges for excellent surface roughness in machining titanium and Inconel
	MF																	0.12~0.50 0.3~6.0	For Light cutting <ul style="list-style-type: none"> Low cutting resistance for light cutting
	MM																	0.20~0.70 0.3~6.0	For General cutting <ul style="list-style-type: none"> Universal purpose for most of milling applications
	None C/B																0.3~0.5	0.30~0.50	For Machining high hardness steel <ul style="list-style-type: none"> Ideal for machining high hardness mold steel and heat resistant alloy
Triple Mill series	ML																0.10~0.30 1.0~15.5	For Hard-to-cut material machining <ul style="list-style-type: none"> Stable tool life and cutting performance in hard-to-cut material cutting due to low cutting load chip breaker 	
	MM																0.10~0.30 1.0~15.5	For General cutting <ul style="list-style-type: none"> For general cutting range with optimal shape for general milling 	
HFM	MF															0.1~0.4	0.30~1.0	For Light cutting <ul style="list-style-type: none"> Chip breaker for cutting with low cutting load is optimal for light cutting 	
	None C/B															0.1~0.4	0.30~0.80	For Machining high hardness steel <ul style="list-style-type: none"> Shape with hard cutting edge is optimal for high hardness alloy steel machining 	

Notice: Application ranges are based on main cutting material



Chip breaker for drilling

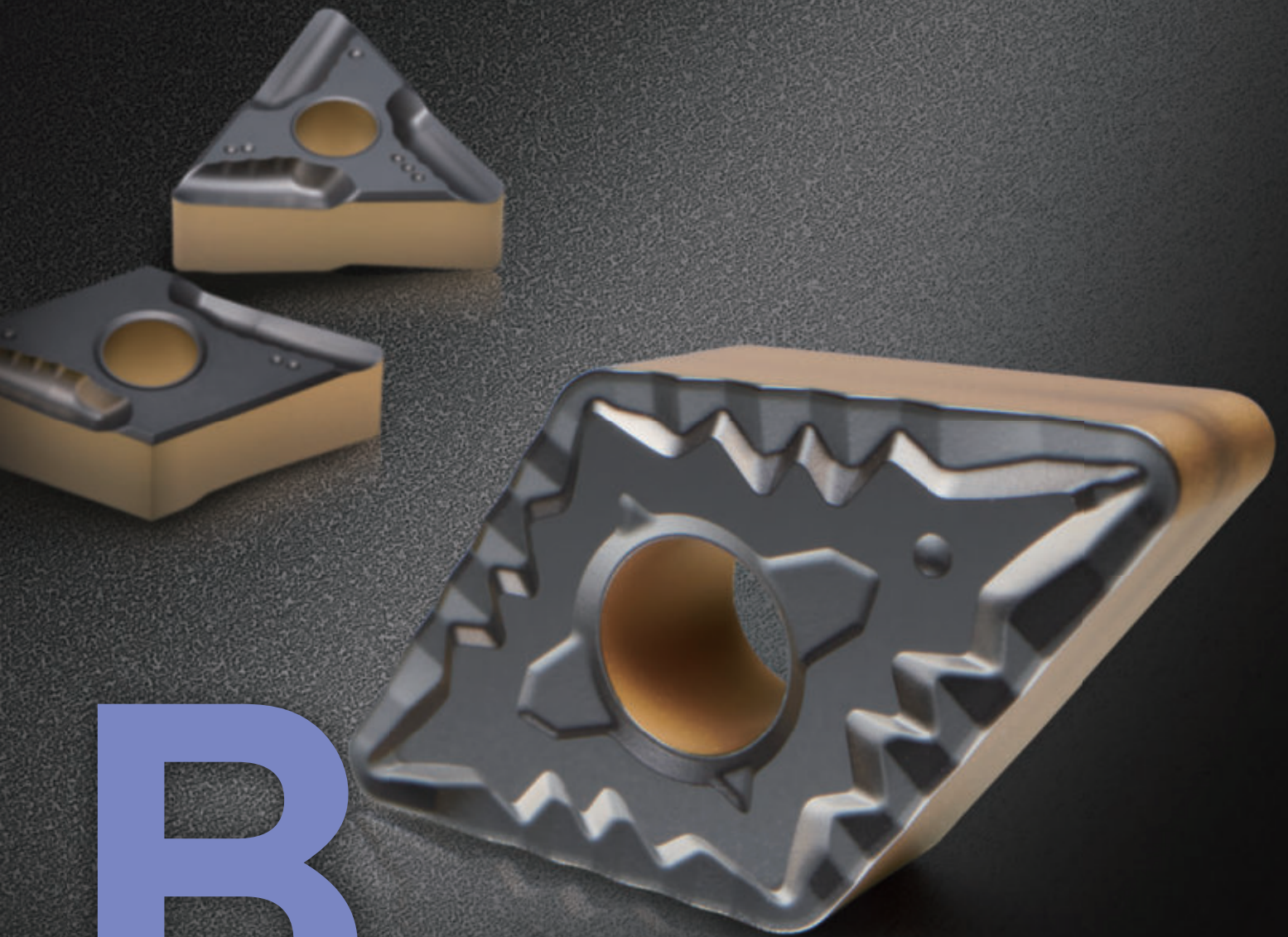
Geometry	Cutting edge	Application range												Features									
		feed rate f_n (mm/rev)																					
		0.04	0.063	0.10	0.16	0.25	0.4	0.63	1.0	1.6	2.5	4.0	6.3										
depth of cut a_p (mm)																							
												30	60	90	120	150	180	210	240	270	300	330	900
King Drill series	PD			<div style="display: flex; justify-content: space-between;"> <div style="background-color: #ADD8E6; padding: 2px;">0.04~0.20</div> <div style="background-color: #90EE90; padding: 2px;">60~300</div> </div>												<p>For General cutting</p> <ul style="list-style-type: none"> Chip breaker with strong cutting edge for universal applications with steel, stainless steel, and cast iron 							
	LD			<div style="display: flex; justify-content: space-between;"> <div style="background-color: #ADD8E6; padding: 2px;">0.04~0.15</div> <div style="background-color: #90EE90; padding: 2px;">40~250</div> </div>												<p>For Light cutting</p> <ul style="list-style-type: none"> Superior chip control in machining of mild steel, forged steel and stainless steel 							
	RD			<div style="display: flex; justify-content: space-between;"> <div style="background-color: #ADD8E6; padding: 2px;">0.04~0.20</div> <div style="background-color: #90EE90; padding: 2px;">60~300</div> </div>												<p>Reinforced chipping resistance</p> <ul style="list-style-type: none"> Improved central chipping resistance due to reinforced corners of the King Drill central inserts Excellent cutting performance even in machining where there is frequent corner breakage of central inserts e.g. Machining heat-treated steel or stainless steel, and high feed machining, etc. 							
	ND			<div style="display: flex; justify-content: space-between;"> <div style="background-color: #ADD8E6; padding: 2px;">0.04~0.10</div> <div style="background-color: #90EE90; padding: 2px;">100~400</div> </div>												<p>Non-ferrous metals</p> <ul style="list-style-type: none"> Chip breaker with sharp and polished cutting edge for aluminum and Non-ferrous metals. Machining with King Drill ensures good chip flow and resistance to chip welding 							

Notice: Application ranges are based on main cutting material



TURNING

Korloy turning tools cover a wide application range with a full line-up of ISO tools that produce high quality and high precision parts all for manufacturers' requirements.



B

Turning Chip Breakers

- B02** Application range of KORLOY Main Chip Breakers
- B04** Recommended Chip Breakers for workpiece
- B16** Feature of Chip Breakers

Inserts

- B34** Turning Insert Code System (ISO)
- B36** Turning Insert (Negative)
- B73** Turning Insert (Positive)
- B102** Aluminum Insert (Positive)
- B110** cBN Insert
- B113** PCD Insert

SAVE TURN

- B114** Technical Information for SAVE TURN
- B115** SAVE TURN Insert
- B116** SAVE TURN Holder
- B119** SAVE TURN Boring Bar

Auto Tools

- B121** Technical Information for Auto Tools
- B122** ISO Type
- B127** KHP Coolant
- B136** Blade Type
- B139** Multi Utility Type
- B142** KGT/MGT Type
- B145** MSB Tool
- B151** Sleeve

Multi Turn

- B152** Technical Information for Multi Turn
- B154** Multi Turn

Bearing Solutions

- B155** Technical Information for Bearing Solution
- B156** Bearing Solution
- B161** Special Order Form for Bearing Inserts

External Tool Holder

- B162** External Tool Holder Code System (ISO)
- B163** Index for External Holder
- B166** Instruction of External Holder
- B167** Double Clamp System
- B172** Lever Lock System
- B179** Wedge Clamp System
- B181** Clamp On System
- B183** Multi Lock System
- B190** Screw On System
- B197** Ceramic Holder

High Pressure Coolant

- B199** Technical Information for KHP Coolant
- B202** KHP Coolant

Boring Bar

- B204** Boring Bar Code System (ISO)
- B205** Index for Boring Bar
- B207** Instruction of Boring Bar assembly
- B208** Double Clamp System
- B210** Lever Lock System
- B212** Clamp On System
- B213** Multi Lock System
- B215** Screw On System
- B225** Compact Mini

HSK/KM Tooling System

- B228** Technical Information for HSK/KM Tooling System
- B230** Index for HSK/KM Tooling System
- B231** HSK Tooling System
- B237** KM Tooling System

Cartridges

- B241** Cartridge Code System (ISO)
- B242** Index for Cartridge
- B243** Clamp On System
- B245** Screw On System

B Turning Chip Breakers

Applications range of chip breakers

➤ Negative inserts

Workpiece P
Steel

Heavy			
Roughing			
Medium cutting			
Medium to finishing			
Finishing			

[Recommended]

Workpiece K
Cast iron

Roughing			
Medium cutting			
Medium to finishing			
Finishing			

[Recommended]

Workpiece M
Stainless steel

Roughing			
Medium cutting			
Medium to finishing			
Finishing			

[Recommended]

Workpiece N
Aluminum alloy

Medium to finishing			
---------------------	--	--	--

[Recommended]

Workpiece S
Heat resistant alloy

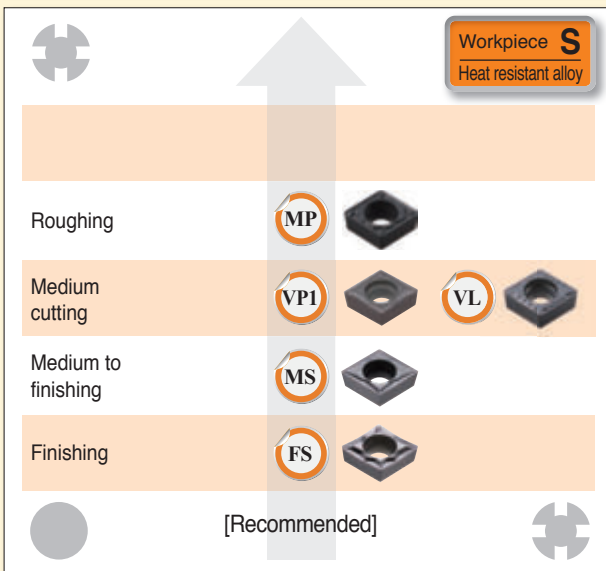
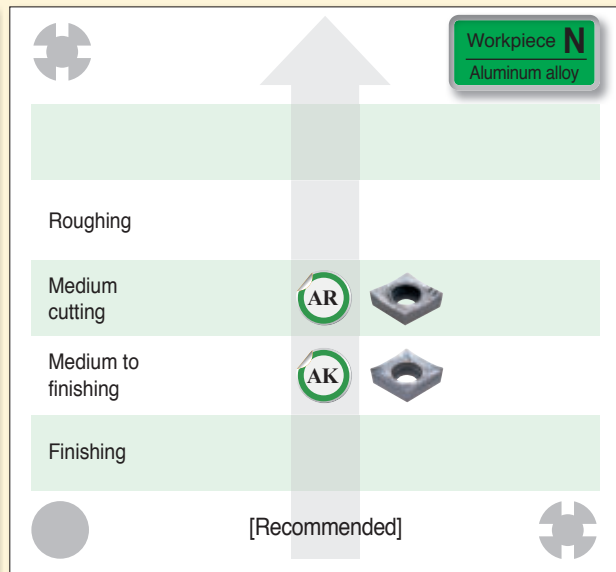
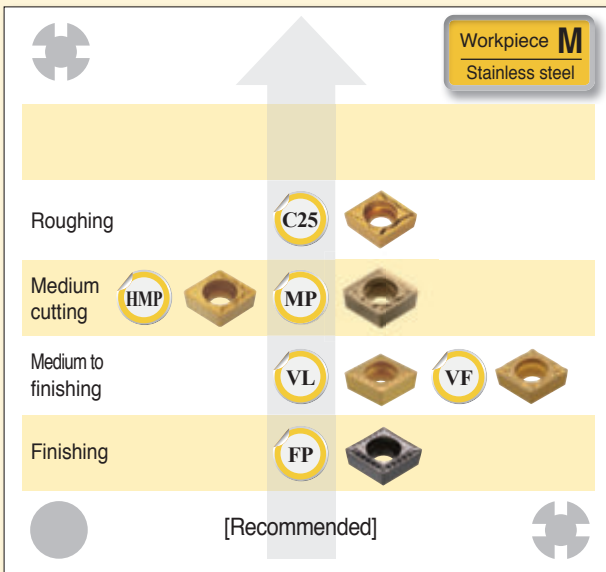
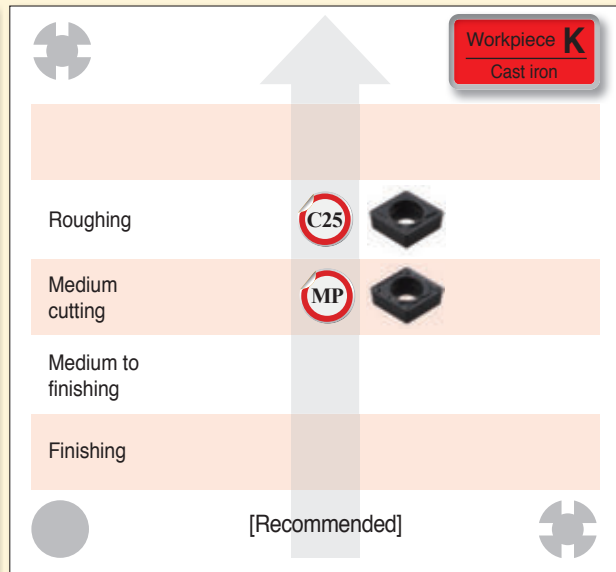
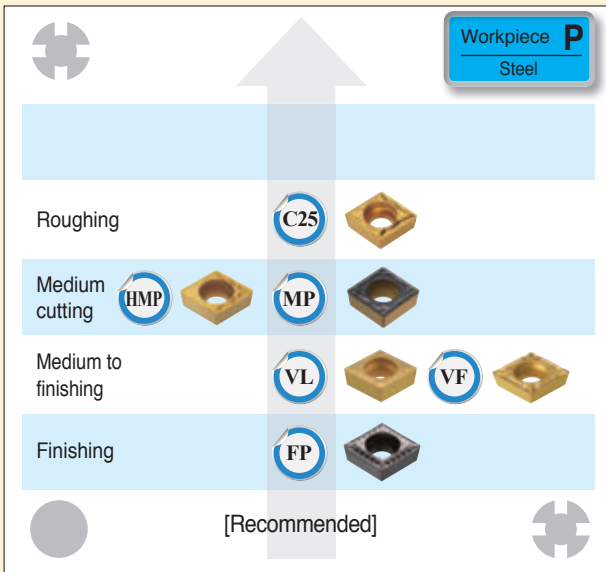
Roughing			
Medium cutting			
Medium to finishing			
Finishing			

[Recommended]



Applications range of chip breakers

Positive inserts



B Turning Chip Breakers

Workpiece
P
Steel

Recommended chip breaker for workpiece

Materials: SM10C, SM15C, SM25C, SS400, SCr415, SCM415, etc. Soft steel

Hardness: under 180HB

Depth of cut (mm)	C/B	Cutting edge	Feed (mm/rev)	Grades	Cutting Speed (m/min)	Insert shape						
Negative	0.2 ~ 0.8 ~ 1.5 Finishing	VL 		0.10 ~ 0.20 ~ 0.35	NC3215 NC3225 CN1500 CN2500	305 250 260 230	CNMG 	DNMG 	SNMG 	TNMG 	VNMG 	WNMG
	0.5 ~ 1.0 ~ 2.0 Finishing	VB 		0.15 ~ 0.20 ~ 0.40	NC3215 NC3225 CN1500 CN2500	340 250 240 210	CNMG 	DNMG 		TNMG 		WNMG
	0.5 ~ 1.0 ~ 1.5 Finishing	VF 		0.05 ~ 0.15 ~ 0.35	NC3215 NC3220 NC3225 NC5330	305 270 270 210	CNMG 	DNMG 	SNMG 	TNMG 	VNMG 	WNMG
	0.5 ~ 1.5 ~ 3.5 Medium to finishing	VC 		0.12 ~ 0.25 ~ 0.45	NC3215 NC3220 NC3225 NC5330	285 250 255 200	CNMG 	DNMG 	SNMG 	TNMG 	VNMG 	WNMG
	0.5 ~ 1.0 ~ 3.5 Medium to finishing	LP 		0.10 ~ 0.25 ~ 0.40	NC3215 NC3225 NC5330	300 250 200	CNMG 	DNMG 	SNMG 	TNMG 	VNMG 	WNMG
	0.5 ~ 1.3 ~ 3.5 Medium to finishing	VQ 		0.12 ~ 0.2 ~ 0.42	NC3215 NC3225 NC5330	300 250 200	CNMG 	DNMG 	SNMG 	TNMG 	VNMG 	WNMG
	0.5 ~ 1.3 ~ 3.5 Medium to finishing	CP 		0.1 ~ 0.28 ~ 0.35	NC3215P NC3225P	285 250	CNMG 	DNMG 	SNMG 	TNMG 	VNMG 	WNMG
	0.5 ~ 1.5 ~ 4.5 Medium cutting	MP 		0.15 ~ 0.30 ~ 0.45	NC3215 NC3225 NC5330	300 265 200	CNMG 	DNMG 	SNMG 	TNMG 	VNMG 	WNMG
	1.0 ~ 2.5 ~ 5.0 Medium cutting	VM 		0.10 ~ 0.25 ~ 0.50	NC3215 NC3220 NC3225 NC5330 CN1500 CN2500	295 260 260 205 220 200	CNMG 	DNMG 	SNMG 	TNMG 	VNMG 	WNMG
	1.5 ~ 2.5 ~ 5.5 Medium cutting	HM 		0.12 ~ 0.28 ~ 0.52	NC3215 NC3225 NC5330	300 265 200	CNMG 	DNMG 	SNMG 	TNMG 	VNMG 	WNMG


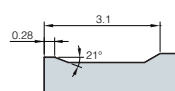






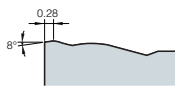



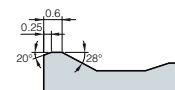



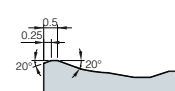


• The first recommended cutting condition



Workpiece
P
 Steel

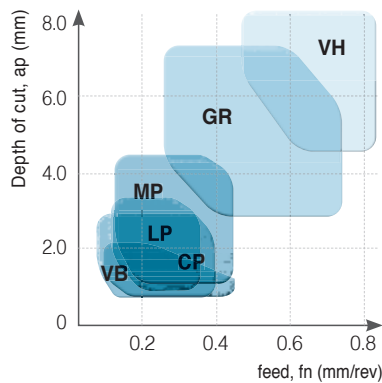
Recommended chip breaker for workpiece

Materials: SM10C, SM15C, SM25C, SS400, SCr415, SCM415, etc. Soft steel
Hardness: under 180HB

Depth of cut (mm)	C/B	Cutting edge	Feed (mm/rev)	Grades	Cutting Speed (m/min)	Insert shape					
						80°	55°	90°	60°	35°	80°
Negative	1.0 ~ 3.0 ~ 4.5 Roughing			0.20 ~ 0.35 ~ 0.50	NC3125 NC3225 NC5330	180~370 150~330 130~280	CNMG  p. B38	DNMG  p. B45	SNMG  p. B52	TNMG  p. B60	WNMG  p. B69
	3.0 ~ 7.0 ~ 11.0 Heavy			0.30 ~ 0.80 ~ 1.30	NC3125 NC3225 NC5330	180~370 150~330 130~280	CNMM  p. B42		SNMM  p. B57		
	6.0 ~ 10.0 ~ 15.0 Heavy (General)			0.70 ~ 1.00 ~ 1.40	NC3215 NC3030 NC500H NC5330	50~250 50~150 50~150 50~150	CNMM  p. B42		SNMM  p. B57		
	7.0 ~ 12.0 ~ 17.0 Heavy (High feed cutting)			0.75 ~ 1.20 ~ 1.60	NC3215 NC3030 NC500H NC5330	50~250 50~150 50~150 50~150	CNMM  p. B42		SNMM  p. B57		

● The first recommended cutting condition

P Negative



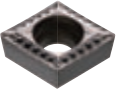
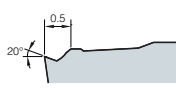






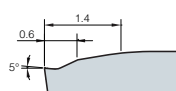






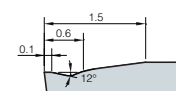





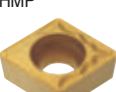
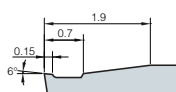






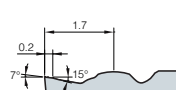






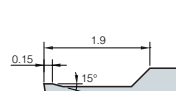




B Turning Chip Breakers

Workpiece
P
Steel

Recommended chip breaker for workpiece

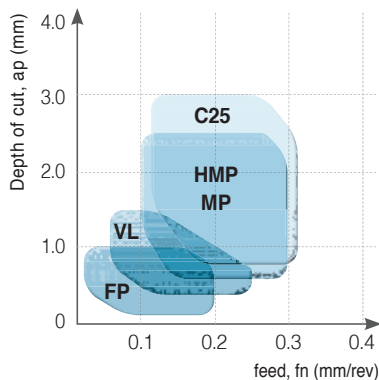
Materials: SM10C, SM15C, SM25C, SS400, SCr415, SCM415, etc. Soft steel

Hardness: under 180HB

Depth of cut (mm)	C/B	Cutting edge	Feed (mm/rev)	Grades	Cutting Speed (m/min)	Insert shape						
						80°	55°	90°	60°	35°	80°	
Positive	0.1 ~ 1.0 Finishing	FP 		0.01 ~ 0.20	NC3215 NC3225 CN1500 CN2500	350 270 260 240	CCMT  p. B73	DCMT  p. B79	SCMT  p. B84	TCMT  p. B88	VB(C)MT  p. B94	
	0.1 ~ 1.0 Medium to finishing	VL 		0.05 ~ 0.20	NC3215 NC3220 NC3225 NC5330 CN1500 CN2500	305 270 270 210 260 240	CCMT  p. B73	DCMT  p. B79	SCMT  p. B84	TCMT  p. B88	VB(C)MT  p. B94	
	0.1 ~ 1.5 Medium to finishing	VF 		0.05 ~ 0.25	NC3215 NC3220 NC3225 NC5330 CC1500 CN1500 CN2500	305 270 270 210 260 250 230	CCMT  p. B73	DCMT  p. B79	SCMT  p. B84	TC(P)MT  p. B88	VB(C)MT  p. B94	
	0.6 ~ 2.5 Medium cutting	HMP 		0.10 ~ 0.30	NC3215 NC3220 NC3225 NC5330 CN1500 CN2500	320 285 285 225 240 220	CCMT  p. B73	DCMT  p. B79	SCMT  p. B84	TCMT  p. B88	VB(C)MT  p. B94	
	0.6 ~ 2.5 Medium cutting	MP 		0.10 ~ 0.30	NC3215 NC3225 CN1500 CN2500	300 250 240 200	CCMT  p. B73	DCMT  p. B79	SCMT  p. B84	TC(P)MT  p. B88	VB(C)MT  p. B94	
	0.8 ~ 3.0 Roughing	C25 		0.12 ~ 0.32	NC3215 NC3220 NC3225 NC5330 CN1500 CN2500	320 285 285 225 230 210	CCMT  p. B74	DCMT  p. B80	SCMT  p. B84	TCMT  p. B89		

• The first recommended cutting condition

P Positive


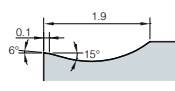




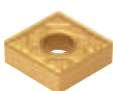
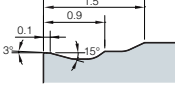







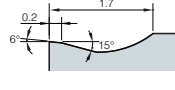







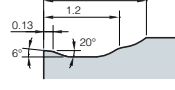






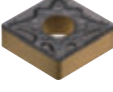
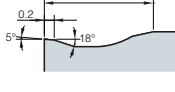







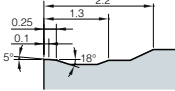







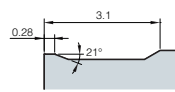






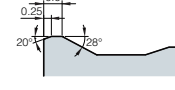



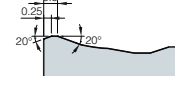




Workpiece
P
Steel

Recommended chip breaker for workpiece

Materials: SM45C, SM55C, SCM430, SCM440, etc. General steel

Hardness: under 180~260HB

Depth of cut (mm)	C/B	Cutting edge	Feed (mm/rev)	Grades	Cutting Speed (m/min)	Insert shape						
						80°	55°	90°	60°	35°	80°	
Negative	0.5 ~ 1.0 ~ 2.0 Finishing	VB 		0.15 ~ 0.20 ~ 0.40	NC3215 NC3225 CN1500 CN2500	340 250 230 190	CNMG 	DNMG 		TNMG 		WNMG 
	0.5 ~ 1.0 ~ 1.5 Finishing	VF 		0.08 ~ 0.15 ~ 0.35	NC3215 NC3225 NC5330	305 270 250	CNMG 	DNMG 	SNMG 	TNMG 	VNMG 	WNMG 
	0.5 ~ 1.0 ~ 3.5 Medium to finishing	VC 		0.12 ~ 0.25 ~ 0.45	NC3215 NC3220 NC3225 NC5330	285 255 250 200	CNMG 	DNMG 	SNMG 	TNMG 	VNMG 	WNMG 
	0.5 ~ 1.0 ~ 2.5 Medium cutting	LP 		0.10 ~ 0.25 ~ 0.40	NC3215 NC3225 NC5330	300 250 200	CNMG 	DNMG 	SNMG 	TNMG 	VNMG 	WNMG 
	0.5 ~ 1.5 ~ 4.5 Medium cutting	MP 		0.15 ~ 0.30 ~ 0.45	NC3215 NC3225 NC5330	300 250 200	CNMG 	DNMG 	SNMG 	TNMG 	VNMG 	WNMG 
	1.0 ~ 2.5 ~ 5.0 Medium cutting	VM 		0.15 ~ 0.25 ~ 0.50	NC3215 NC3220 NC3225 NC5330 CN1500 CN2500	260 245 245 205 210 170	CNMG 	DNMG 	SNMG 	TNMG 	VNMG 	WNMG 
	1.0 ~ 3.0 ~ 4.5 Medium to roughing	GR 		0.20 ~ 0.35 ~ 0.50	NC3125 NC3225 NC5330	180~370 150~330 130~280	CNMG 	DNMG 	SNMG 	TNMG 		WNMG 
	6.0 ~ 10.0 ~ 15.0 Heavy (General)	VH 		0.70 ~ 1.00 ~ 1.40	NC3215 NC3030 NC500H NC5330	50~250 50~150 50~150 50~150	CNMM 		SNMM 			
	7.0 ~ 12.0 ~ 17.0 Heavy (High feed cutting)	VT 		0.75 ~ 1.20 ~ 1.60	NC3215 NC3030 NC500H NC5330	50~250 50~150 50~150 50~150	CNMM 		SNMM 			

• The first recommended cutting condition



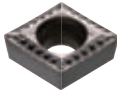
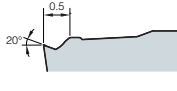






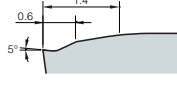






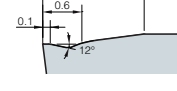





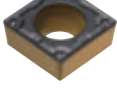
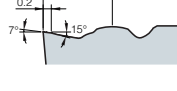






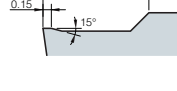




B Turning Chip Breakers

Workpiece
P
Steel

Recommended chip breaker for workpiece

Materials: SM45C, SM55C, SCM430, SCM440, etc. General steel

Hardness: under 180~260HB

Depth of cut (mm)	C/B	Cutting edge	Feed (mm/rev)	Grades	Cutting Speed (m/min)	Insert shape						
						80°	55°	90°	60°	35°	80°	
Positive	0.1 ~ 1.0 0.5 Finishing	FP 		0.01 ~ 0.06 0.06 ~ 0.20	NC3215 NC3225 CN1500 CN2500	350 270 260 240	CCMT  p. B73	DCMT  p. B79	SCMT  p. B84	TCMT  p. B88	VB(C)/MT  p. B94	
	0.4 ~ 1.0 0.5 Medium to finishing	VL 		0.05 ~ 0.10 0.10 ~ 0.25	NC3215 NC3220 NC3225 NC5330 CN1500 CN2500	345 310 310 240 250 210	CCMT  p. B73	DCMT  p. B79	SCMT  p. B84	TCMT  p. B88	VB(C)/MT  p. B94	
	0.1 ~ 1.5 0.5 Medium to finishing	VF 		0.05 ~ 0.15 0.15 ~ 0.25	NC3215 NC3220 NC3225 NC5330 CC1500 CN1500 CN2500	265 300 300 230 260 240 210	CCMT  p. B73	DCMT  p. B79	SCMT  p. B84	TC(P)/MT  p. B88	VB(C)/MT  p. B94	
	0.6 ~ 2.5 1.5 Medium cutting	MP 		0.10 ~ 0.15 0.15 ~ 0.30	NC3215 NC3225	300 250	CCMT  p. B73	DCMT  p. B79	SCMT  p. B84	TC(P)/MT  p. B88	VB(C)/MT  p. B94	
	0.8 ~ 3.0 2.0 Roughing	C25 		0.12 ~ 0.15 0.15 ~ 0.32	NC3215 NC3220 NC3225 NC5330 CN1500 CN2500	320 285 285 225 230 200	CCMT  p. B74	DCMT  p. B80	SCMT  p. B84	TCMT  p. B89		

• The first recommended cutting condition



Workpiece
P
Steel

Recommended chip breaker for workpiece

Materials: SNC415, SNC815, SNCM240, SNCM439, STS12, STS61, etc
SCM440, Hardened steel

Hardness: 260~350HB

Depth of cut (mm)	C/B	Cutting edge	Feed (mm/rev)	Grades	Cutting Speed (m/min)	Insert shape						
Negative	0.5 ~ 1.0 ~ 2.0 Finishing			0.15 ~ 0.20 ~ 0.40	NC3215 NC3225 CN1500 CN2500	200 148 220 200	CNMG 	DNMG 		TNMG 		WNMG
	0.5 ~ 1.0 ~ 1.5 Finishing			0.08 ~ 0.15 ~ 0.30	NC3215 NC3220 NC3225	180 159 159	CNMG 	DNMG 	SNMG 	TNMG 	VNMG 	WNMG
	0.5 ~ 1.5 ~ 3.5 Medium to finishing			0.12 ~ 0.25 ~ 0.45	NC3215 NC3220 NC3225 NC5330	168 148 150 200	CNMG 	DNMG 	SNMG 	TNMG 	VNMG 	WNMG
	0.5 ~ 1.0 ~ 2.5 Medium cutting			0.10 ~ 0.25 ~ 0.40	NC3215 NC3225 NC5330	250 200 200	CNMG 	DNMG 	SNMG 	TNMG 	VNMG 	WNMG
	0.5 ~ 1.5 ~ 4.5 Medium cutting			0.15 ~ 0.25 ~ 0.45	NC3215 NC3225 NC5330	250 200 200	CNMG 	DNMG 	SNMG 	TNMG 	VNMG 	WNMG
	1.0 ~ 2.5 ~ 5.0 Medium cutting			0.15 ~ 0.25 ~ 0.50	NC3215 NC3220 NC3225 CN1500 CN2500	174 153 153 120 100	CNMG 	DNMG 	SNMG 	TNMG 	VNMG 	WNMG
	1.0 ~ 3.0 ~ 4.5 Medium to roughing			0.20 ~ 0.35 ~ 0.50	NC3125 NC3225 NC5330	180~370 150~330 130~280	CNMG 	DNMG 	SNMG 	TNMG 		WNMG
	6.0 ~ 10.0 ~ 15.0 Heavy (General)			0.70 ~ 1.00 ~ 1.40	NC3215 NC3030 NC500H NC5330	50~250 50~150 50~150 50~150	CNMM 		SNMM 			
	7.0 ~ 12.0 ~ 17.0 Heavy (High feed cutting)			0.75 ~ 1.20 ~ 1.60	NC3215 NC3030 NC500H NC5330	50~250 50~150 50~150 50~150	CNMM 		SNMM 			

• The first recommended cutting condition



B Turning Chip Breakers

Workpiece
P
Steel

Recommended chip breaker for workpiece

Materials: SNC415, SNC815, SNCM240, SNCM439, STS12, STS61, etc
SCM440, Hardened steel
Hardness: 260~350HB

Depth of cut (mm)	C/B	Cutting edge	Feed (mm/rev)	Grades	Cutting Speed (m/min)	Insert shape					
Positive	0.1 ~ 0.5 ~ 1.0 Finishing	FP 		0.01 ~ 0.06 ~ 0.20	NC3215 NC3225 CN1500 CN2500	350 270 260 240	CCMT p. B73	DCMT p. B79	SCMT p. B84	TCMT p. B88	VB(C)MT p. B94
	0.4 ~ 0.5 ~ 1.5 Medium to finishing	VL 		0.05 ~ 0.10 ~ 0.25	NC3215 NC3220 NC3225 NC5330 CN1500 CN2500	305 310 310 240 210 190	CCMT p. B73	DCMT p. B79	SCMT p. B84	TCMT p. B88	VB(C)MT p. B94
	0.1 ~ 0.5 ~ 1.5 Medium to finishing	VF 		0.05 ~ 0.15 ~ 0.25	NC3215 NC3220 NC3225 NC5330 CC1500 CN1500 CN2500	330 300 300 230 260 250 240	CCMT p. B73	DCMT p. B79	SCMT p. B84	TC(P)MT p. B88	VB(C)MT p. B94
	0.6 ~ 1.5 ~ 2.5 Medium cutting	MP 		0.10 ~ 0.15 ~ 0.30	NC3215 NC3225 NC5300 CN1500 CN2500	305 285 225 240 220	CCMT p. B73	DCMT p. B79	SCMT p. B84	TC(P)MT p. B88	VB(C)MT p. B94
	0.8 ~ 2.0 ~ 3.0 Roughing	C25 		0.12 ~ 0.15 ~ 0.32	NC3215 NC3220 NC3225 NC5330 CN1500 CN2500	320 285 285 225 100 80	CCMT p. B74	DCMT p. B80	SCMT p. B84	TCMT p. B89	

• The first recommended cutting condition



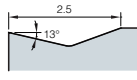
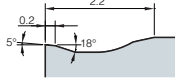
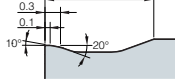
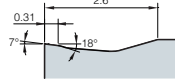
Workpiece
M
Stainless steel

Recommended chip breaker for workpiece

Materials: STS304, STS316, STS430, STS630

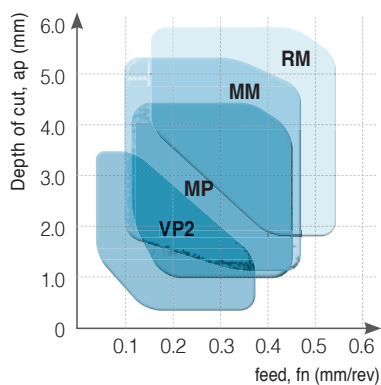
Ferrite, austenite, martensite, precipitation hardening stainless steels

Hardness: 135~300HB

Depth of cut (mm)	C/B	Cutting edge	Feed (mm/rev)	Grades	Cutting Speed (m/min)	Insert shape					
						80°	55°	90°	60°	35°	80°
Negative	0.5 ~ 1.5 ~ 4.0 Medium to finishing	VP2 	0.10 ~ 0.20 ~ 0.40	PC8105 PC8110 PC8115 PC5300 PC5400	185 170 160 135 120	CNMG p. B41	DNMG p. B47	SNMG p. B55	TNMG p. B63	VNMG	WNMG p. B71
	1.0 ~ 2.0 ~ 4.5 Medium cutting	MP 	0.15 ~ 0.23 ~ 0.45	PC8105 PC8110 PC8115 PC5300 PC5400	175 160 150 130 110	CNMG p. B37	DNMG p. B44	SNMG p. B51	TNMG p. B59	VNMG p. B66	WNMG p. B69
	0.5 ~ 3.0 ~ 5.5 Medium cutting	MM 	0.12 ~ 0.25 ~ 0.45	NC9115 NC9125 NC9135 PC8110 PC8115 PC5300	190 170 130 160 150 130	CNMG p. B40	DNMG p. B46	SNMG p. B54	TNMG p. B62	VNMG p. B67	WNMG p. B71
	2.0 ~ 4.0 ~ 6.0 Roughing	RM 	0.15 ~ 0.30 ~ 0.55	NC9115 NC9125 NC9135 PC8110 PC8115 PC5300	190 170 130 160 150 130	CNMG p. B40	DNMG p. B47	SNMG p. B55	TNMG p. B63	VNMG p. B67	WNMG p. B71

• The first recommended cutting condition

M Negative



B Turning Chip Breakers

Workpiece
M
Stainless steel

Recommended chip breaker for workpiece

Materials: STS304, STS316, STS430, STS630

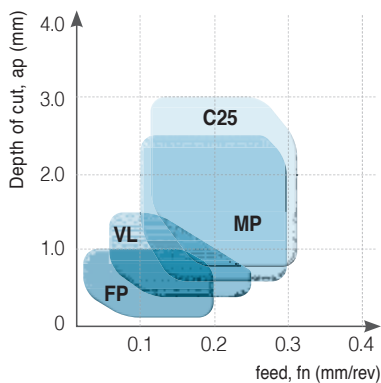
Ferrite, austenite, martensite, precipitation hardening stainless steels

Hardness: 135~300HB

Depth of cut (mm)	C/B	Cutting edge	Feed (mm/rev)	Grades	Cutting Speed (m/min)	Insert shape					
						80°	55°	90°	60°	35°	80°
Positive 0.1 ~ 1.0 Finishing	VL		0.05 ~ 0.10 ~ 0.20	PC8105 PC8110 PC8115 PC5300 PC5400 NC5330 NC9025	215 195 190 165 135 165 165	CCMT p. B73	DCMT p. B79	SCMT p. B84	TCMT p. B88	VB(C)/MT p. B94	
	HMP		0.05 ~ 0.10 ~ 0.25	PC8105 PC8110 PC8115 PC5400 NC5330 NC9025	190 175 170 120 150 150	CCMT p. B73	DCMT p. B79	SCMT p. B84	TCMT p. B88	VB(C)/MT p. B94	
	MP		0.05 ~ 0.15 ~ 0.35	PC8105 PC8110 PC8115 PC5400 NC5330 NC9025	190 175 170 120 150 150	CCMT p. B73	DCMT p. B79	SCMT p. B84	TC(P)/MT p. B88	VB(C)/MT p. B94	
	C25		0.08 ~ 0.13 ~ 0.25	PC8110 PC5300 PC9030	170 155	CCMT p. B74	DCMT p. B80	SCMT p. B84	TCMT p. B89		

• The first recommended cutting condition

M Positive



Workpiece
K
Cast iron

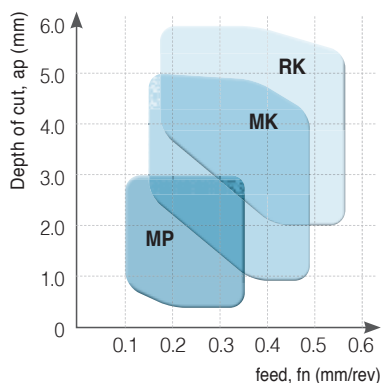
Recommended chip breaker for workpiece

Materials: GC250, GC300, GCD400, GCD700, etc : Gray cast iron, Ductile cast iron
Hardness: 135~185HB
Tensile strength: under 450N/mm²

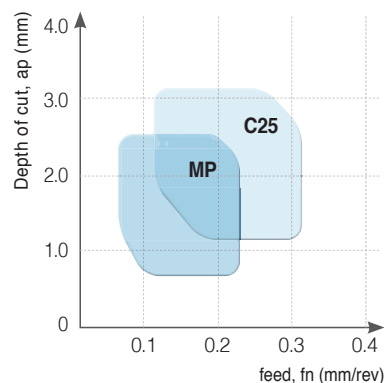
Depth of cut (mm)	C/B	Cutting edge	Feed (mm/rev)	Grades	Cutting Speed (m/min)	Insert shape						
						80°	55°	90°	60°	35°	80°	
Negative	1.0 ~ 3.0 ~ 4.5 Roughing	VR 		0.20 ~ 0.35 ~ 0.60	NC6310	220~420	CNMG p. B39	DNMG p. B46	SNMG p. B54	TNMG p. B62	WNMG p. B70	
	1.5 ~ 3.0 ~ 6.0 Roughing	RK 		0.20 ~ 0.30 ~ 0.60	NC6310	350~550	CNMG p. B39	DNMG p. B46	SNMG p. B54	TNMG p. B62	WNMG p. B70	
	1.0 ~ 2.5 ~ 6.0 Roughing	C/B none 		0.15 ~ 0.30 ~ 0.60	DB1000 DBN500 DBN700A NC6310 NC6315	150 ~ 200 200 ~ 500 500 ~ 2000 140 ~ 420 120 ~ 290	CNMA p. B39	DNMA p. B46	SNMA p. B53	TNMA p. B61		
	1.0 ~ 2.5 ~ 5.0 Medium ~ Medium to finishing	MK 		0.10 ~ 0.25 ~ 0.50	NC6310	350~550	CNMG p. B38	DNMG p. B46	SNMG p. B53	TNMG p. B61	VNMG p. B67	WNMG p. B70
	0.5 ~ 2.0 ~ 3.5 Medium to finishing	B25 		0.20 ~ 0.35 ~ 0.60	NC6310 NC6315	140~380 120~290	CNMG p. B38	DNMG p. B45	SNMG p. B52	TNMG p. B60		
	0.5 ~ 1.0 ~ 2.5 Finishing	MP 		0.10 ~ 0.25 ~ 0.45	NC6310 NC6315	140~380 120~290	CNMG p. B37	DNMG p. B44	SNMG p. B51	TNMG p. B59	VNMG p. B66	WNMG p. B69
Positive	1.0 ~ 3.0 ~ 4.5 Roughing	MP 		0.10 ~ 0.20 ~ 0.35	NC6310	225~290	CCMT p. B73	DCMT p. B79	SCMT p. B84	TC(P)MT p. B88	VB(C)MT p. B94	
	1.5 ~ 3.0 ~ 6.0 Roughing	C25 		0.10 ~ 0.25 ~ 0.40	NC6310 NC6315	285~340 200	CCMT p. B74	DCMT p. B80	SCMT p. B84	TCMT p. B89		

• The first recommended cutting condition

K Negative



K Positive



B Turning Chip Breakers

Workpiece
N
Aluminum alloy

Recommended chip breaker for workpiece

Materials: Aluminum alloy

Hardness: 20~110HB

Depth of cut (mm)	C/B	Cutting edge	Feed (mm/rev)	Grades	Cutting Speed (m/min)	Insert shape					
						80°	55°	90°	60°	35°	80°
Negative 0.5 ~ 2.0 ~ 6.0 Medium cutting	HA		0.10 ~ 0.20 ~ 0.50	H01	500	CNMG	DNMG	SNMG	TNMG	VNMG	WNMG
Positive 0.1 ~ 1.0 ~ 4.0 Medium to finishing	AK		0.03 ~ 0.20 ~ 0.40	H01 ND1000 PD1000	1000 1000 1000	CCGT	DCGT	SCGT	TCGT	VB(C)GT	RCGT
0.5 ~ 1.5 ~ 4.0 Medium cutting	AR		0.05 ~ 0.30 ~ 0.50	H01 ND1000 PD1000	1000 1000 1000	CCGT	DCGT	SCGT	TCGT	VB(C)GT	RCGT

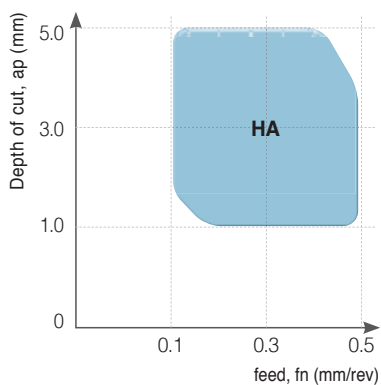
Materials: Copper, Bronze alloy

Hardness: 20~110HB

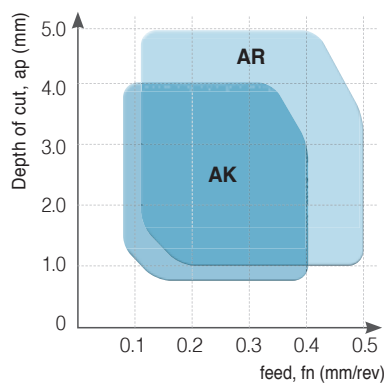
Depth of cut (mm)	C/B	Cutting edge	Feed (mm/rev)	Grades	Cutting Speed (m/min)	Insert shape					
						80°	55°	90°	60°	35°	80°
Negative 0.5 ~ 2.0 ~ 4.0 Medium to finishing	HA		0.10 ~ 0.20 ~ 0.50	H01	1000	CNMG	DNMG	SNMG	TNMG	VNMG	WNMG
Positive 0.1 ~ 1.0 ~ 3.0 Medium to finishing	AK		0.03 ~ 0.20 ~ 0.30	H01	1000	CCGT	DCGT	SCGT	TCGT	VB(C)GT	RCGT
0.5 ~ 1.5 ~ 3.0 Medium cutting	AR		0.05 ~ 0.25 ~ 0.40	H01	1000	CCGT	DCGT	SCGT	TCGT	VB(C)GT	RCGT

•: The first recommended cutting condition

N Negative



N Positive



Workpiece
S
Heat resistant alloy

Recommended chip breaker for workpiece

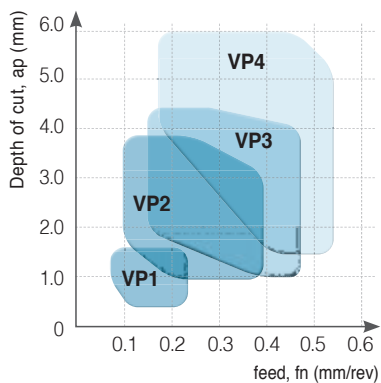
Materials: Inconel, Nimonic, Stellite, Ti alloy

Hardness: 160~350HB

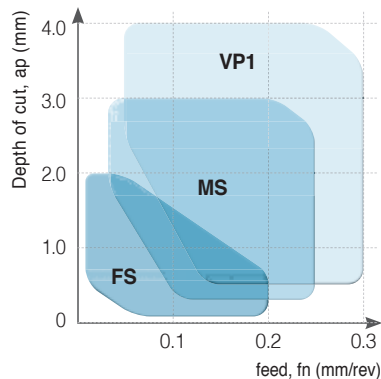
Depth of cut (mm)	C/B	Cutting edge	Feed (mm/rev)	Grades	Cutting Speed (m/min)	Insert shape						
						80°	55°	90°	60°	35°	80°	
Negative	0.1 ~ 0.5 ~ 1.5 Finishing	VP1		0.05 ~ 0.10 ~ 0.20	PC8110 PC5300 NC5330	60 50 50	CNGG p. B40	DNGG p. B47				
	0.5 ~ 1.5 ~ 4.0 Medium to finishing	VP2		0.10 ~ 0.20 ~ 0.40	PC8110 PC5300	60 45	CNMG p. B41	DNMG p. B47	SNMG p. B55	TNMG p. B63		WNMG p. B71
	0.05 ~ 2.0 ~ 3.0 Medium cutting	VP3		0.05 ~ 0.15 ~ 0.25	PC8110 PC5300	60 40	CNMG p. B41	DNMG p. B47	SNMG p. B55	TNMG p. B63	VNMG p. B67	WNMG p. B71
	1.0 ~ 2.5 ~ 4.0 Roughing	VP4		0.15 ~ 0.20 ~ 0.35	PC8115	60 40	CNMG p. B41	DNMG p. B48	SNMG p. B55	TNMG p. B63		WNMG p. B71
Positive	0.5 ~ 2.0 ~ 4.0 Medium cutting	VP1		0.05 ~ 0.23 ~ 0.30	PC8110 PC5300	60 45	CCGT p. B74	DCGT p. B81			VCGT p. B98	
	0.2 ~ 1.0 ~ 2.5 Medium cutting	MS		0.03 ~ 0.10 ~ 0.25	PC8110 PC5300	60 45	CCGT p. B74	DCGT p. B80			VCGT p. B98	
	0.1 ~ 0.8 ~ 1.5 Finishing	FS		0.01 ~ 0.08 ~ 0.20	PC8110 PC5300	60 45	CCGT p. B74	DCGT p. B80		TCGT p. B89	VCGT p. B98	

●: The first recommended cutting condition

S Negative



S Positive



Features of Chip Breaker

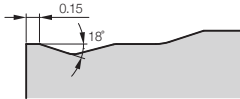
CP Chip Breaker new [For medium to finishing]

- Chip breaker with strong cutting edge for heavy interruption in the range of medium to finishing
- Effective chip control in the range from low depth of cut to high depth of cut due to 2-stepped back angle
- Stable chip evacuation and breaking long chip in deep cutting by side rake angle and continuous bumps

Features of CP chip breaker

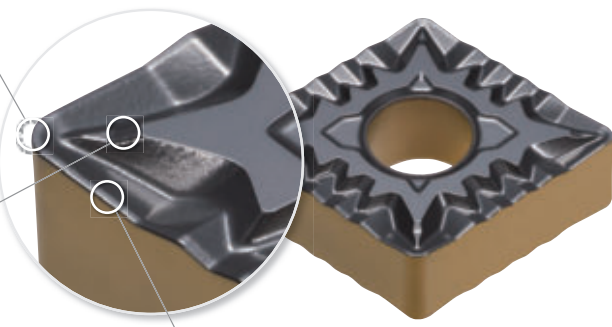
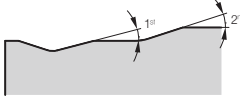
► Flat land

- Strong cutting edge in interrupted roughing
- Keeping the balance between continuous cutting and interrupted cutting
- Expanded versatility



► 2-stepped back side

- Better chip control in low depth of cut machining
- Improved chip evacuation in high feed machining
- Expanded versatility by 2-stepped rake angle



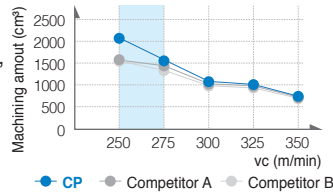
► Side rake angle + continuous bumps

- Enhanced surface finish
- Improved chip evacuation
- Breaking long chips

Performance evaluation

V-T (Vc-Tool life)

- **Workpiece** Alloy steel (SCM440), External machining
- **Cutting condition** vc (m/min) = 250, 300, 350, fn (mm/rev) = 0.3, ap (mm) = 0.5, wet
- **Tools** Insert : CNMG120408-RM (NC9115)
Holder : PCLNL2525-M12



CP



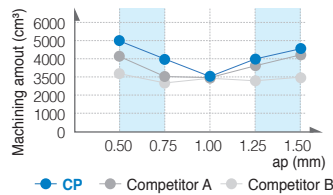
Competitor A



Competitor B

D-T (Depth of cut-Tool life)

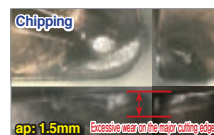
- **Workpiece** Alloy steel (SCM440), External machining
- **Cutting condition** vc (m/min) = 250, fn (mm/rev) = 0.2, ap (mm) = 0.50, 0.75, 1.00, 1.25, 1.50, wet
- **Tools** Insert : CNMG120408-CP (NC3215P)
Holder : PCLNL2525-M12



CP

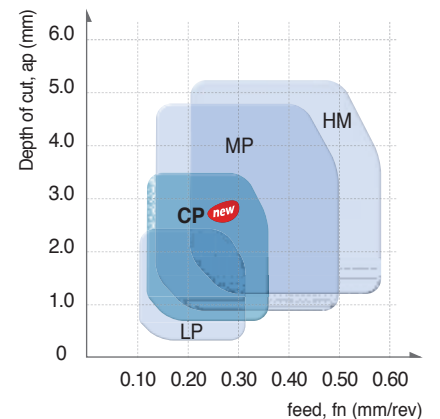


Competitor A



Competitor B

Application range



Features of Chip Breaker

FP Chip Breaker new [For chip control in finishing]

- Chip breaker applied on one side of insert controls chip in mild steel machining with low depth of cut
- Chip control in poor machining (with lower depth of cut than nose R, in machining minor cutting edge and in back cutting)
- Decreased cutting load and excellent surface finish due to 3-dimensional cutting edge and side rake angle

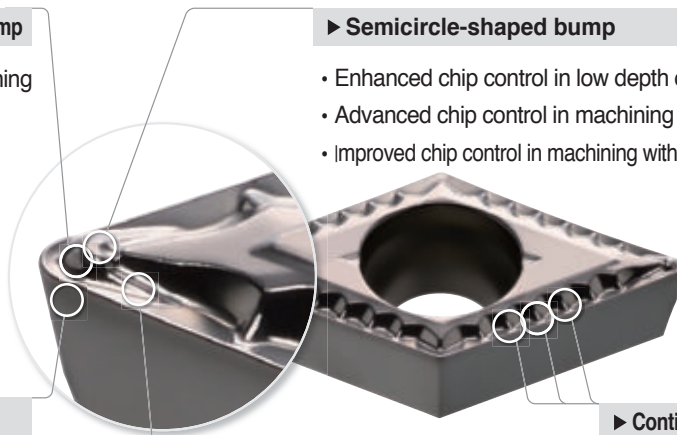
Features of FP chip breaker

► Concave form of semicircle-shaped bump

- Better chip curling in mild steel machining
- Enhanced chip control in low depth of cut and low feed machining

► Semicircle-shaped bump

- Enhanced chip control in low depth of cut machining
- Advanced chip control in machining of minor cutting edge
- Improved chip control in machining with lower depth of cut than nose R



► 3-dimensional side rake angle

- Ensuring surface finish and guiding chip to right direction

► Assistant bump on flank surface

- Better chip curling in high depth of cut and low feed machining
- Preventing chip twist

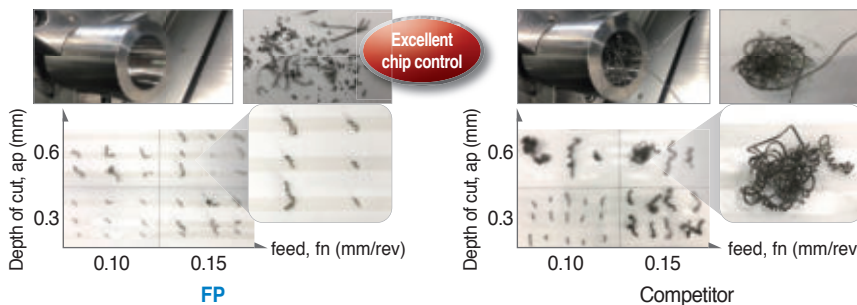
► Continuous bump on flank surface

- Cutting long chip

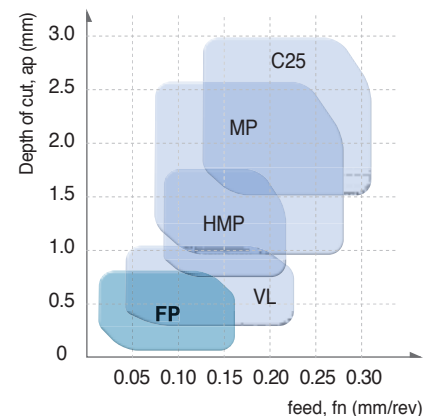
Performance evaluation

Chip control

- **Workpiece** Mild steel (SM20C), Ø40 Internal machining
- **Cutting condition** vc (m/min) = 200, n (rpm) = 1,600, fn (mm/rev) = 0.03, ap (mm) = 0.5, wet
- **Tools** Insert : CCMT09T304-FP (NC3215)
Holder : S16M-SCLCR-M09



Application range



Surface finish

- **Workpiece** Mild steel (SM20C), Ø30 External machining
- **Cutting condition** vc (m/min) = 200, n (rpm) = 2,000, fn (mm/rev) = 0.08, ap (mm) = 0.8, wet
- **Tools** Insert : CCMT09T304-FP (NC3215)
Holder : SCLCR1616-M09



Features of Chip Breaker

FS Chip Breaker new [For finishing]

- Chip breaker for ultra-precision automatic Swiss lathe machining (for lower depth of cut and lower feed cutting range than VP1 and MS)
- Available for various workpieces, P, M and S
- Reduced cutting load and good surface finish due to sharp cutting edge

Features of FS chip breaker

▶ Variable elevated triangular pyramid shape

- Applicable for various cutting range due to optimally designed chip breaker
- Enhanced chip evacuation function per variation of cutting depth
- Enhanced chip control with low depth of cut
- Lowered cutting load in high feed machining

▶ Side high rake angle

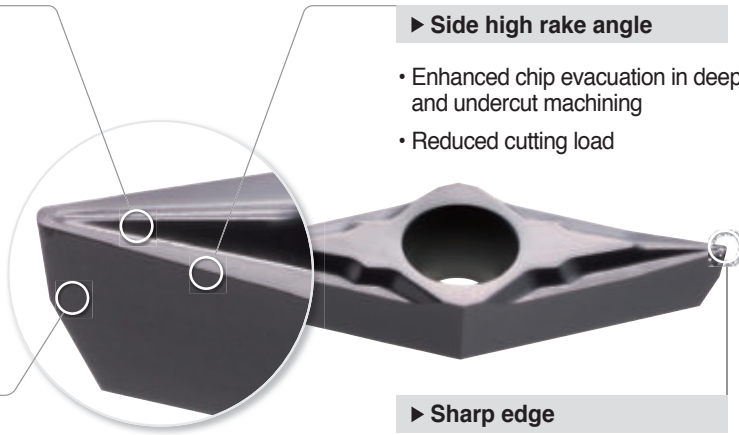
- Enhanced chip evacuation in deep grooving and undercut machining
- Reduced cutting load

▶ Side grinding

- Periphery grinding G class
- High precision grinding

▶ Sharp edge

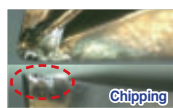
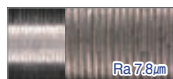
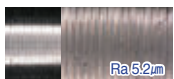
- Reduced cutting resistance
- Improved chip control



Performance evaluation

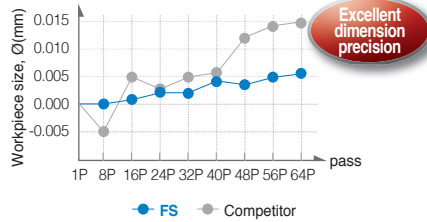
Workpiece size and surface finish

- **Workpiece** Stainless steel (STS406)
- **Cutting condition** vc (m/min) = 80, n (rpm) = 1,000, fn (mm/rev) = 0.05, ap (mm) = 0.1, wet
- **Tools** **Insert** : VCGT110301-FS (PC8110)
Holder : SVJCR1212-X11A



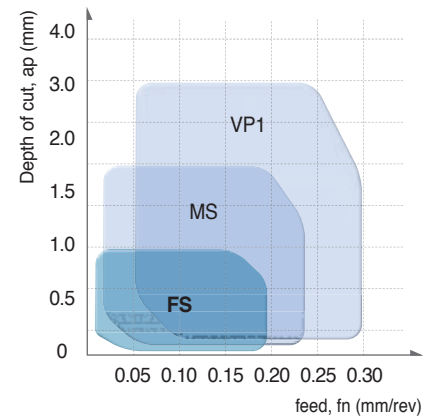
FS

Competitor



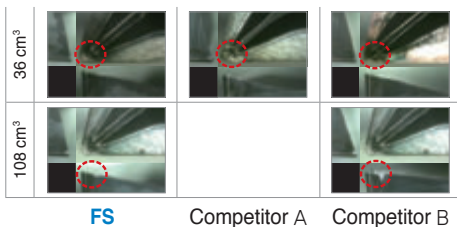
Excellent dimension precision

Application range



Wear resistance

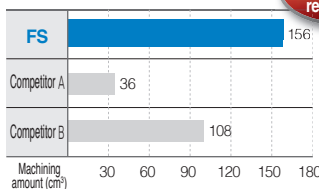
- **Workpiece** Alloy steel (SCM440)
- **Cutting condition** vc (m/min) = 100, n (rpm) = 1,000, fn (mm/rev) = 0.05, ap (mm) = 0.5, wet
- **Tools** **Insert** : CCGT09T304-FS (PC8110)
Holder : SCLCR1212-X09A



FS

Competitor A

Competitor B



Improved wear resistance



Features of Chip Breaker

MS Chip Breaker new [For medium to finishing]

- Sharp cutting edge with welding resistance reducing the cutting heat is necessary for machining hard-to-cut materials
- Chip evacuation is increased in low to high feed cutting conditions

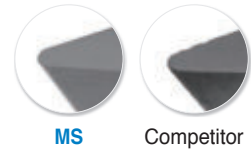
Features of MS chip breaker

▶ Sharp cutting edge

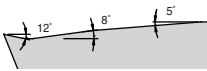
- Decreased cutting heat
- Minimized welding

▶ Flank surface grinding

- G grade of periphery grinding
- Precise grinding



▶ 2-level angle back area



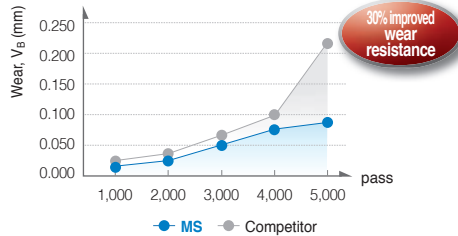
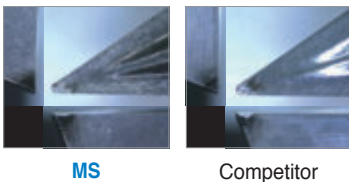
- Improved chip curl and chip control in low feed cutting range
- Better chip evacuation in high feed cutting range

- Reduced cutting resistance
- Protected cutting edge without chip blockage

Performance evaluation

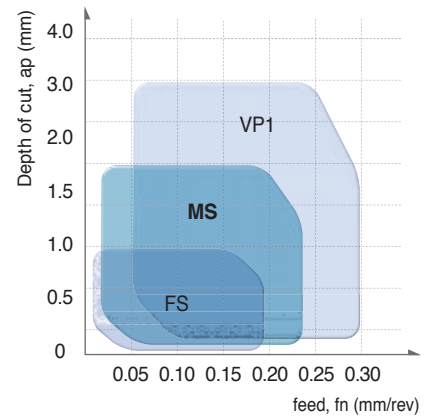
Wear resistance

- **Workpiece** Pure titanium (Grade4)
- **Cutting condition** vc (m/min) = 100, n (rpm) = 3,500, fn (mm/rev) = 0.03, ap (mm) = 0.5, wet
- **Tools** Insert : VCGT1203008FN-MS (PC8110)
Holder : SVJCR1212-X12A

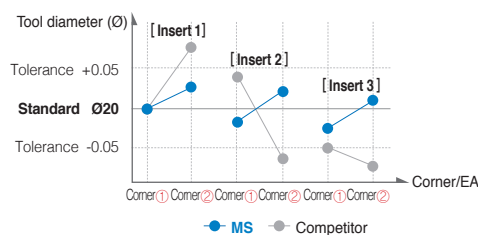
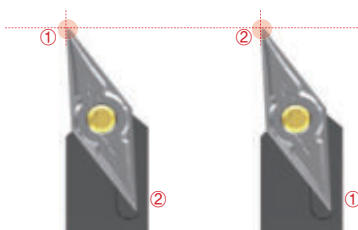


- ▶ Ultra-fine substrate and high hardness coating ensure stable tool life.

Application range



Dimension precision



- ▶ Changing tool offset in switching insert corners and items is not necessary using MS chip breaker due to tight dimension deviation management.

Features of Chip Breaker

LP Chip Breaker new [For medium to finishing]

- Chip breaker for forged steel of automobile parts and normal steel
- Quad dots improve productivity through efficient chip control at high feed
- Angle land minimizes cutting force

Features of LP chip breaker

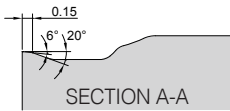
▶ Front dot

- Higher stability of chip curls at high feed
- Excellent chip control when copying
- Lower cutting force at low depth of cut and high feed

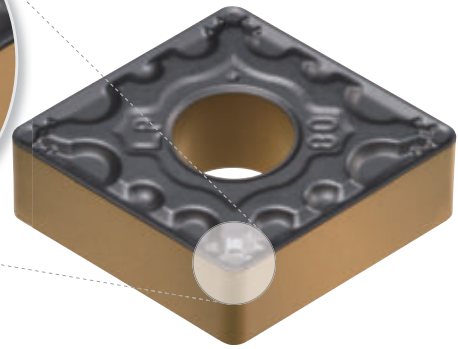
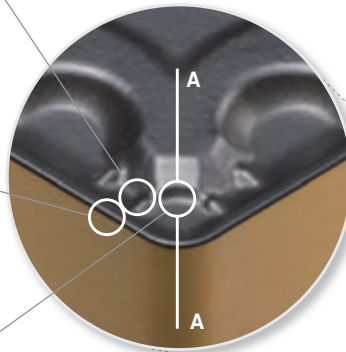
▶ Variable land

- Less crater wear
- Prevents chipping on minor cutting edge

▶ Flat zone



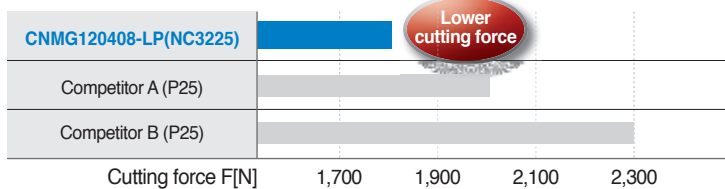
- Larger chip pocket for better chip evacuation at high feed
- Reduced cutting force with larger contact surface of chips



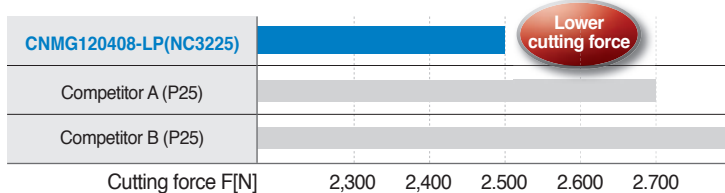
Performance evaluation (Evaluation of cutting force)

- **Workpiece** SM45C, Ø100, External machining
- **Cutting condition** vc (m/min) = 250, ap (mm) = 1.0, fn (mm/rev) = 0.25/0.40, wet
- **Tools** CNMG120408-□□

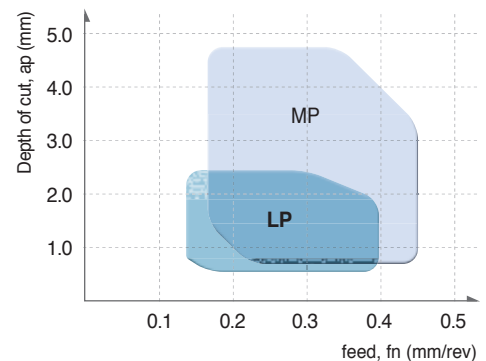
Medium feed (0.25 mm/rev)



High feed (0.40 mm/rev)



Application range



Features of Chip Breaker

MP Chip Breaker new [For medium cutting]

- Chip breaker for forged steel of automobile parts and all other steels
- Quad dots improve productivity through efficient chip control at high feed
- Angle land minimizes cutting force

Features of MP chip breaker

► Front two step dot

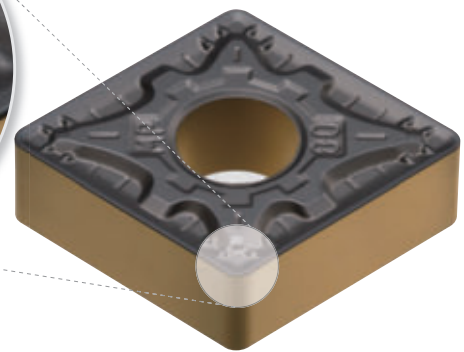
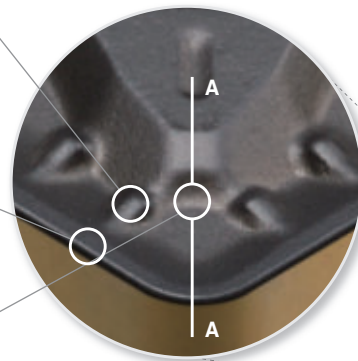
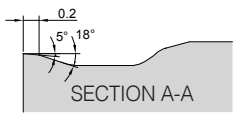
- Higher stability of chip curls at high feed
- Excellent chip control when copying
- Lower cutting force at high depth of cut

► Variable land

- Less crater wear
- Prevents chipping on minor cutting edge
- Higher toughness at high depth of cut and interrupted cutting

► Flat zone

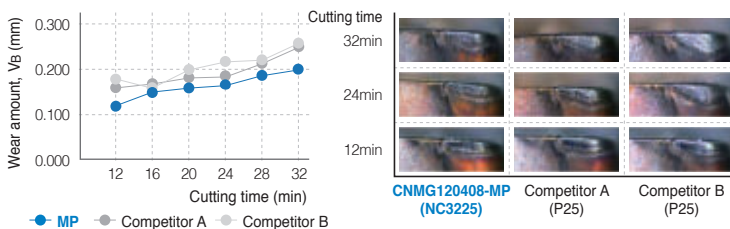
- Larger chip pocket for better chip evacuation at high feed
- Reduced cutting force with larger contact surface of chips



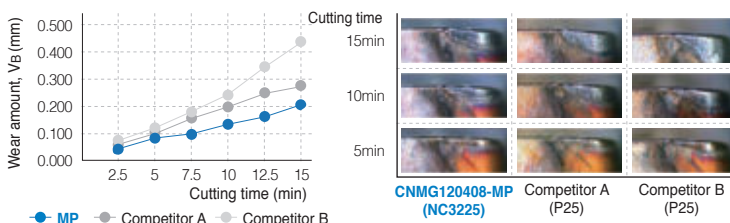
Performance evaluation

- **Workpiece** Alloy steel (SCM440), Ø100, External machining
- **Cutting condition** vc (m/min) = 280, ap (mm) = 1.5, fn (mm/rev) = 0.25/0.40, wet
- **Tools** CNMG120408-□□

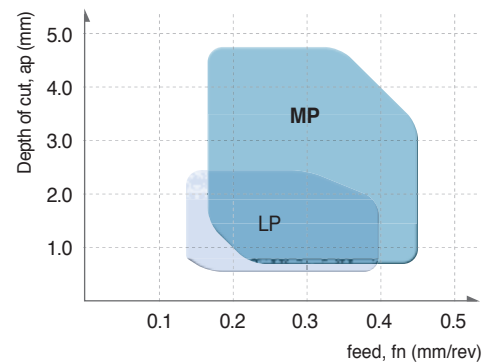
Medium feed (0.25 mm/rev)



High feed (0.40 mm/rev)



Application range



Features of Chip Breaker

MM Chip Breaker new [For medium cutting]

- The 1st recommended chip breaker for stainless steel machining
- Change to: A dual land achieves sharp cutting performance and insert toughness
- Wide chip pockets for stable chip evacuation at high feeds/depths of cut

Features of MM chip breaker

▶ Variable Land

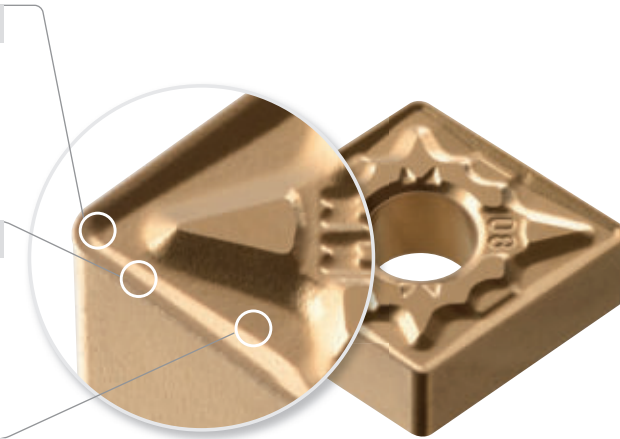
- Excellent chip control and sharp cutting at low depths of cut
- Delays crater wear
- Prevents plastic deformation

▶ Dual Land

- Balance between requirements of sharp and tough cutting edges
- Sharp cutting edge for high speed machining
- Prevents chipping in interrupted machining

▶ Wide Chip Pocket

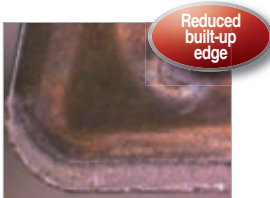
- Stable chip evacuation at high speeds/feeds
- Improved surface finishes by reduced workpiece scratches caused by work-hardened chips at high depths of cut
- Prevents built-up edge



Performance evaluation

Built-up edge

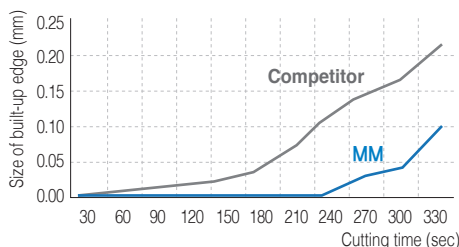
- **Workpiece** STS405 (Ferrite)
- **Cutting condition** vc (m/min) = 180, fn (mm/rev) = 0.3, ap (mm) = 3.0, wet
- **Tools** **Insert** : CNMG120408-MM (NC9125)
Holder : PCLNL2525-M12



MM(NC9125)

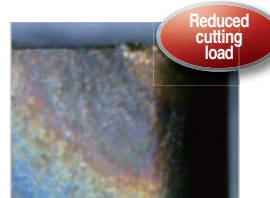


Competitor

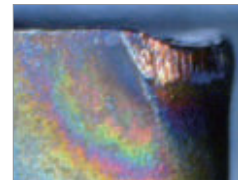


Plastic deformation

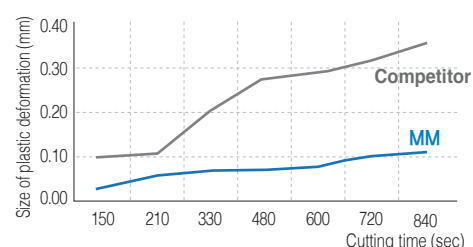
- **Workpiece** STS316 (Austenite)
- **Cutting condition** vc (m/min) = 200, fn (mm/rev) = 0.35, ap (mm) = 2.0, dry
- **Tools** **Insert** : CNMG120408-MM (NC9135)
Holder : PCLNL2525-M12



MM(NC9135)



Competitor



Features of Chip Breaker

RM Chip Breaker new [For roughing]

- The 1st recommended chip breaker for rough and interrupted machining of stainless steel
- Prevents notch wear and burrs at high feeds and depths of cut
- Reduced cutting force extends tool life in high feed machining

Features of RM chip breaker

► **Variable Land**

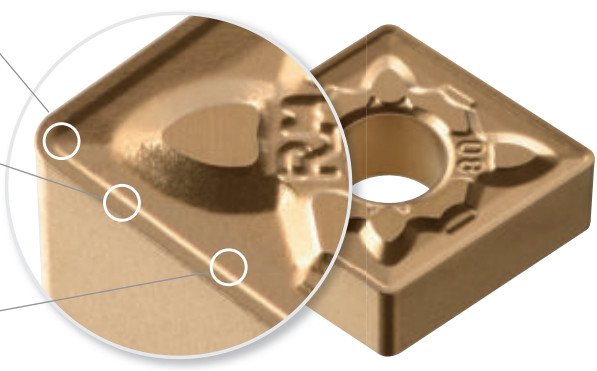
- Excellent chip control and sharp cutting at low depths of cut
- Delays crater wear
- Prevents plastic deformation

► **Wide land & Gentle front angle**

- Sharp cutting edges and a wide land reduce cutting force
- Reduced burrs
- Dispersed cutting load enables higher toughness

► **Stepped Design**

- Stepped design makes chip evacuation easier
- Smooth chip evacuation prevents plastic deformation



Performance evaluation

Notch wear

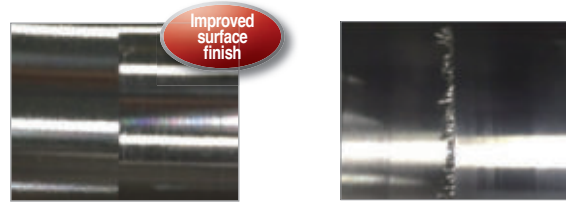
- **Workpiece** STS410 (Martensite)
- **Cutting condition** vc (m/min) = 150, fn (mm/rev) = 0.25, ap (mm) = 3.0, wet
- **Tools** **Insert** : CNMG120408-RM (NC9115)
Holder: PCLNL2525-M12

Burr

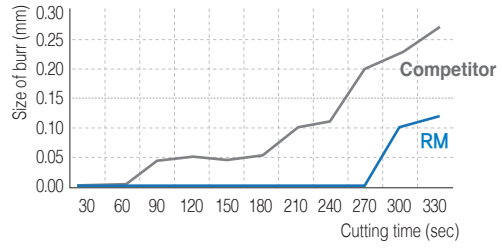
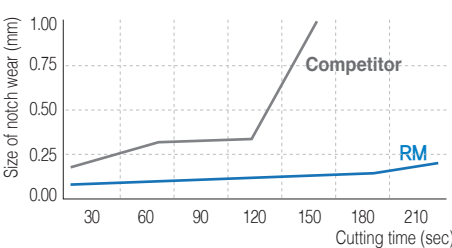
- **Workpiece** Duplex
- **Cutting condition** vc (m/min) = 120, fn (mm/rev) = 0.2, ap (mm) = 2.0, dry
- **Tools** **Insert** : CNMG120408-RM (NC9125)
Holder: PCLNL2525-M12



RM(NC9115) Competitor



RM(NC9125) Competitor



Features of Chip Breaker

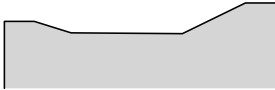
MK Chip Breaker new [For medium cutting]

- Ideally suited for continuous cutting of ductile cast iron and gray cast iron
- Angle lands provide upgraded surface finish

Features of MK chip breaker

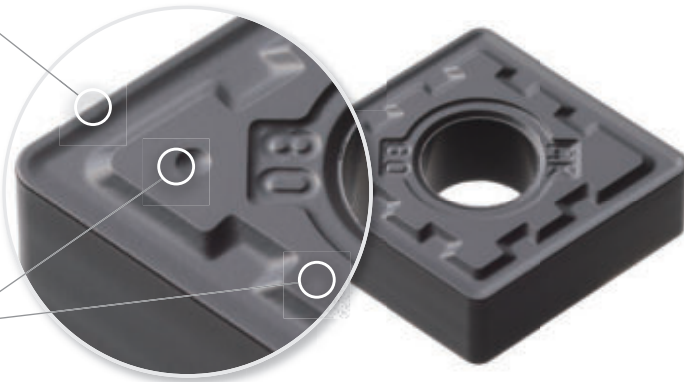
▶ Angle land

- Angle lands provide sharper cutting performance
- Maximized wear resistance in continuous cutting
- High quality results in surface finish



▶ Wide supporting area

- Higher clamping stability
- Prevents chipping at vibrations during operation



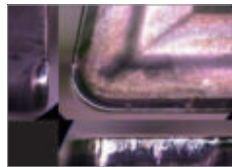
Performance evaluation

Wear resistance

- **Workpiece** GCD500(KS), Ø90 (Spherical tube) → Ø30 machining
- **Cutting conditions** vc (m/min) = 400, fn (mm/rev) = 0.35, ap (mm) = 2.5, wet
- **Cutting time** 30 passes with results of normal wear on rake/flank surface
- **Tools** Insert : CNMG120408-MK (NC6315)
Holder: DCLNR2525-M12

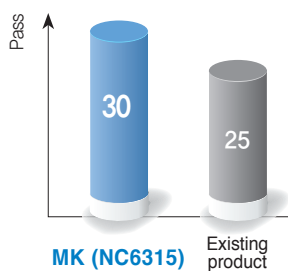


MK (NC6315)

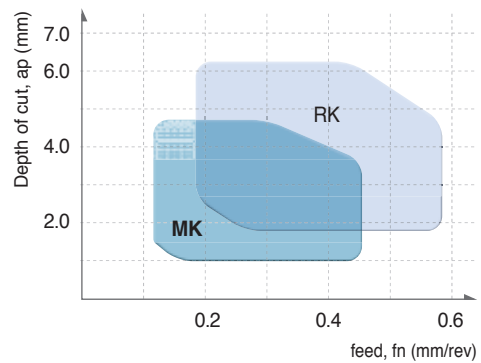


Existing product

130% increased flank wear resistance



Application range



Features of Chip Breaker

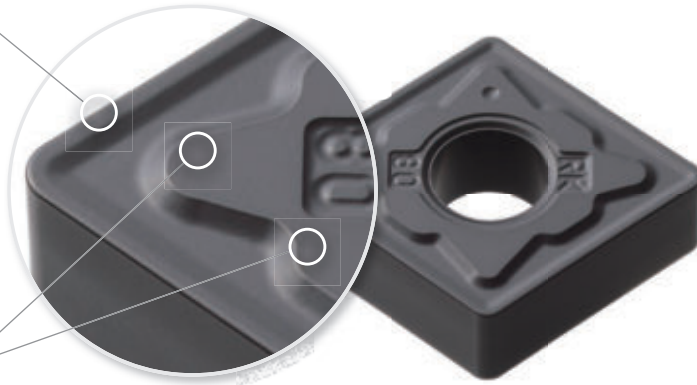
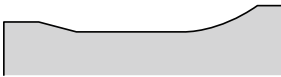
RK Chip Breaker **new** [For roughing]

- Ideally suited for high speed / high feed cutting of ductile cast iron and gray cast iron
- Flat lands provide upgraded toughness and chipping resistance

Features of RK chip breaker

► Flat land

- Flat lands provide upgraded toughness and chipping resistance
- Stable machining availability under high cutting loads at high depth of cuts or interrupted cutting
- Optimized land width for high feed machining



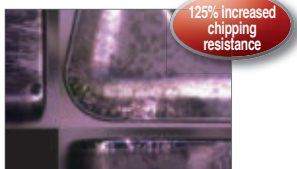
► Wide supporting area

- Higher clamping stability
- Minimizes vibration and chipping.

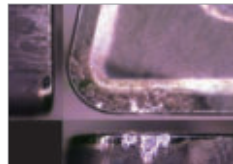
Performance evaluation

Impact resistance

- **Workpiece** GCD500 (KS), Ø90 (Triangular tube) → Ø30 machining
- **Cutting conditions** vc (m/min) = 380, fn (mm/rev) = 0.35, ap (mm) = 2, wet
- **Cutting time** 15 passes with results of normal rake surface wear and good chipping resistance
- **Tools** **Insert** : CNMG120408-RK (NC6315)
Holder : DCLNR2525-M12

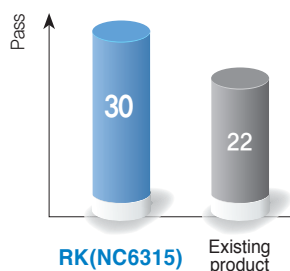
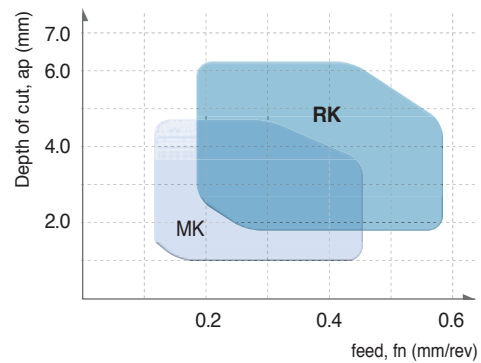


RK(NC6315)



Existing product

Application range



Features of Chip Breaker

VP1 Chip Breaker [For finishing]

- Cutting edges designed in high-positive
 - Reduced contact area between rake surface and chip minimizes cutting heat and improved tool life
- Recommended cutting conditions: f_n (mm/rev) = 0.05~0.2, a_p (mm) = 0.1~1.5

Features of VP1 chip breaker

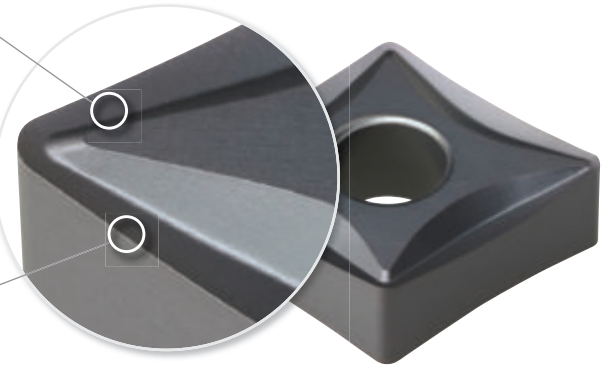
► Optimized design for finishing

- Obtains excellent cutting performance and quality surface finish at low depth of cut and high speed



► High-positive blade design

- Minimizes cutting heat by reducing the contact area between flank surface and chips
- Prevents built-up edge and extends tool life



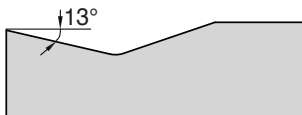
VP2 Chip Breaker [For medium to finishing]

- High-positive cutting edge design/Side rake angle applied
 - Stable chip control improves machinability when ball machining at variable depths of cut
- Recommended cutting conditions: f_n (mm/rev) = 0.1~0.4, a_p (mm) = 0.5~4.5

Features of VP2 chip breaker

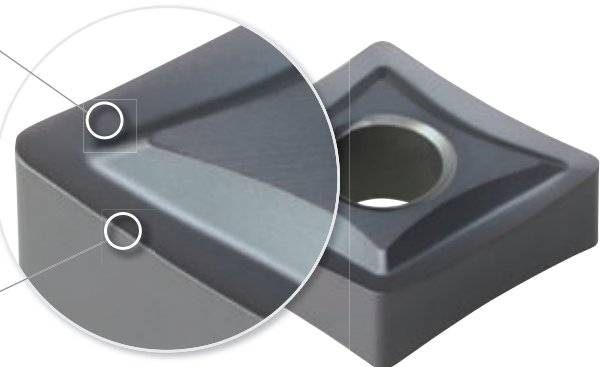
► Sharp blades and wide chip pockets

- Increase productivity
- Ideal for medium to finish cutting



► High-positive blade design

- Improves cutting performance with its stable chip control at varying depth of cuts



Features of Chip Breaker

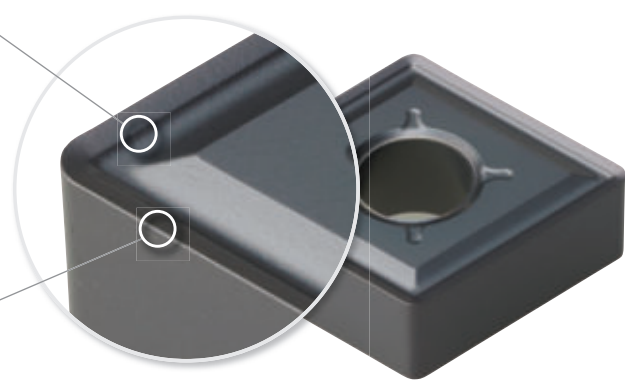
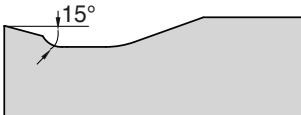
VP3 Chip Breaker [For medium cutting]

- High-positive cutting edge design/Wide land applied
 - Improved stability at interrupted cutting when toughness is required. Stable chip control and machinability at high depth of cut
- Recommended cutting conditions: f_n (mm/rev) = 0.1~0.45, a_p (mm) = 0.5~5.0

Features of VP3 chip breaker

► Chip pocket design leading to a R-shaped cutting edge

- Creates a stepped space between edge and land to make smooth chip flow at low and high depth of cuts



► High-positive blade design / Wide land

- Minimize heat concentration at high depth of cut
- Improves stability in interrupted machining of a tough workpiece

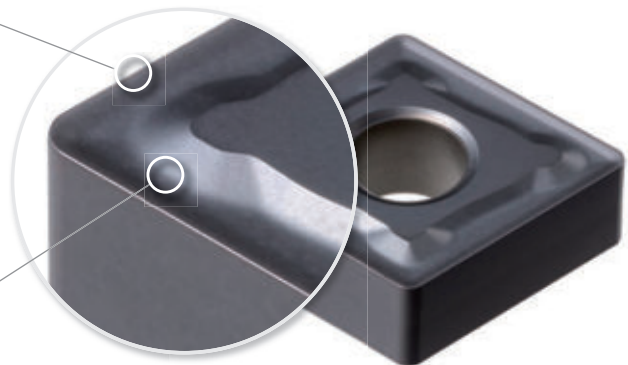
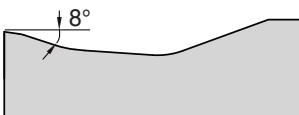
VP4 Chip Breaker **new** [For roughing]

- The 1st recommended chip breakers for machining Inconel which remains highly resistant to and hard at high temperature
- Rough machining stability resulting from reinforced cutting edges and wide chip pockets

Features of VP4 chip breaker

► Rake angle design resistant to high hardness cutting

- Reinforces cutting edges and prevents notch wear in rough surface machining
- Prevents chipping in interrupted cutting



► Wide chip pockets

- Reduce cutting loads and improve stability even at high depth of cut in roughing

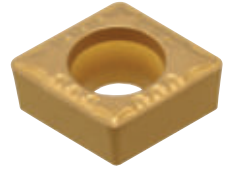


Features of Chip Breaker

Single-sided VL Chip Breaker

[For finishing]

- The sharp flank surface and the chip breaker design significantly improve chip control when machining tough materials such as low carbon steel, pipe steel, and iron plates
- Sharp cutting edges reduce cutting resistance and provide excellent chip control at low depth of cuts, leading to stable machining on automated production lines



Features of VL chip breaker

• Sharp cutting edges

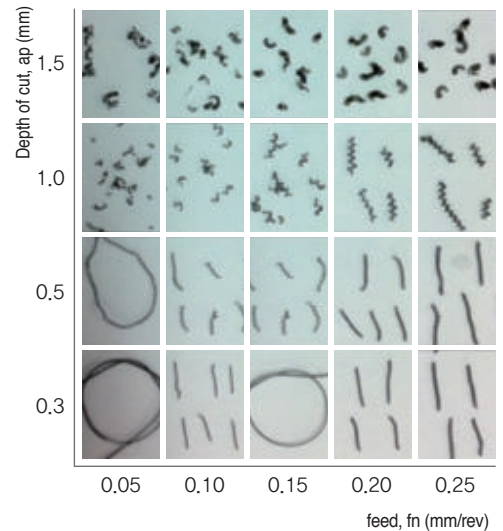
- High rake cutting edges provide improved surface finishes
- Low cutting resistance reduces cutting heat

• 2-step rear rake angle

- Stable chip control regardless of varying feed rates
- Excellent machinability even when machining mild workpieces

Chip control test

- **Workpiece** SCM440(Alloy steel), Ø50, Internal diameter turning
- **Cutting condition** $vc = 250$ m/min, $ap = 0.3\sim 1.5$ mm, $fn = 0.05\sim 0.25$ mm/rev
- **Tools** CCMT09T304-VL



Single-sided MP Chip Breaker

[For medium to finishing]

- For continuous cutting of forged steel at high feed
- Turning insert for internal machining of automobile components

Features of MP chip breaker

• Three-dimensional 2 step chip breaker

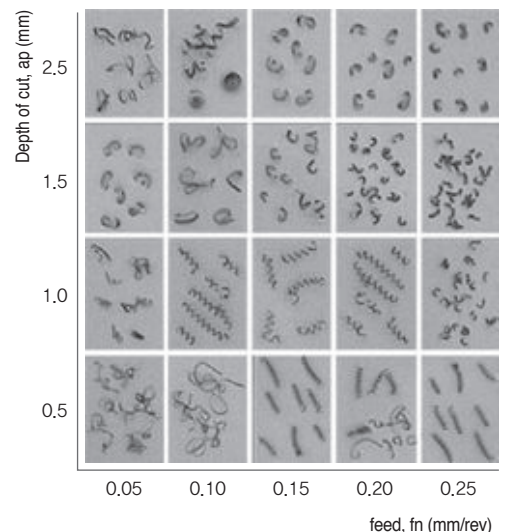
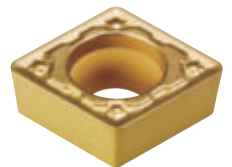
- Stable chip control in unstable internal machining
- Prevents chip blocking at internal diameter at varying depth of cut and feed.

• Stronger cutting edge and wide chip pocket

- Increased chipping resistance in unstable internal machining

Chip control test

- **Workpiece** SCM440
- **Cutting condition** $vc = 200$ m/min, $ap = 0.5\sim 2.5$ mm, $fn = 0.05\sim 0.25$ mm/rev
- **Tools** CCMT09T304-MP



Features of Chip Breaker

VL Chip Breaker [For finishing]



- Improved chip control for machining material that have high toughness such as low carbon steel, pipe, steel plate etc
- Improved chip control and decreased cutting load on external, facing, and copying applications
- Improved strength of the cutting edge for measurable efficiency in automated production

Features of VL chip breaker

- **2 steps designed chip-breaker** - Suitable Mild steel
- Stable chip control on the low feed and cutting depth
- **Designed with special dots** - Stable chip breaking on the low cutting depth
- **Applied side rake angle** - Improved chip control on facing, copying applications
- Decreased cutting load and better surface finish

Chip control test

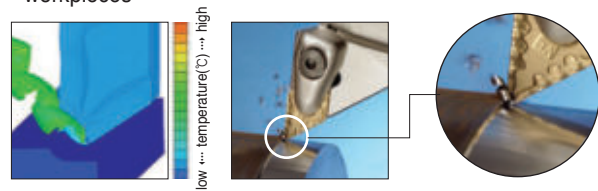
- **Workpiece** SM20C
- **Cutting conditions** $vc = 250$ m/min, $ap = 0.5$ mm
 $fn = 0.2$ mm/rev (Side), dry
- **Tools** DNMG150408-VL



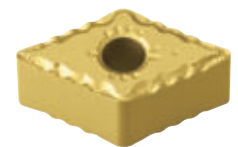
VL Chip Breakers

FEM Cutting simulation analysis in the design

- For design of geometry, chip shapes and chip flow are predictable
- Optimal chip breaker design by various cutting conditions and workpieces



VB Chip Breaker [For finishing]



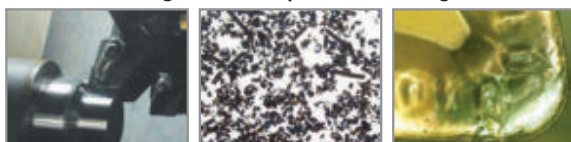
- Excellent chip evacuation in continuous and high speed machining of various workpieces
- 3-dimensional chip breaker achieves lower cutting resistance, high rigidity of the cutting edge, and longer tool life
- Stable chip control in copying and internal machining

Features of VB chip breaker

- **6 bumps on the insert corner** - Superior chip control and chip cutting in copying with various depths of cut
- **Side rake angle** - Superb chip cutting in facing and copying. Superior tool life due to improved surface roughness and lower cutting resistance
- **Cutting edge on 100° part for medium machining (For CNMG)** - Excellent chip evacuation and toughness in machining with high depth of cut

Performance

Better machining Better Chip control Longer tool life



VB Chip Breakers



Conventional chip breaker

Features of Chip Breaker

VC Chip Breaker [For medium to finishing]

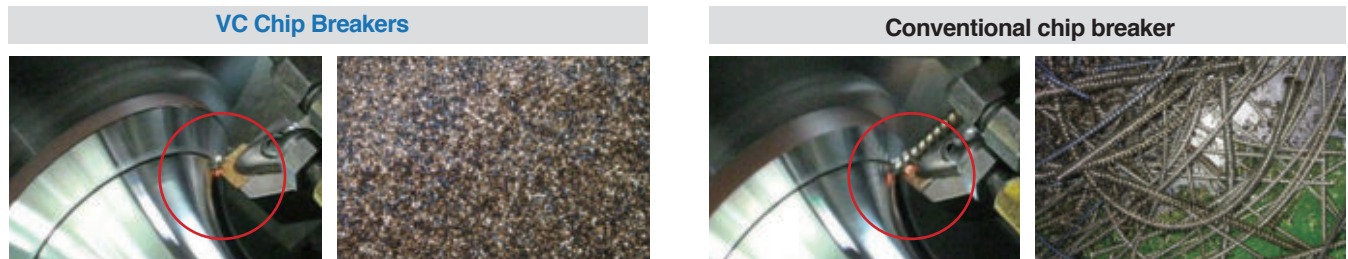
- Superior chip evacuation in high speed and continuous machining of various workpieces (carbon steel, alloy steel etc)
- KORLOY 3 dimensional chip breaker ensures longer tool life due to low cutting load and improved cutting edge strength
- Stable chip control in copying and internal machining



Features of VC chip breaker

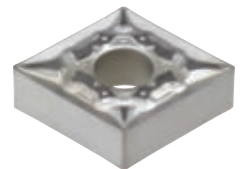
- 4 bumps on the insert corner
 - Excellent chip control in various depths of cut and superb chip cutting in external, internal, copy machining and facing

Evaluation of chip control (Copying)



VQ Chip Breaker [For medium to finishing_For cermet]

- Excellent cutting performance and reinforced cutting edges
- Improved chip control at low depth of cuts

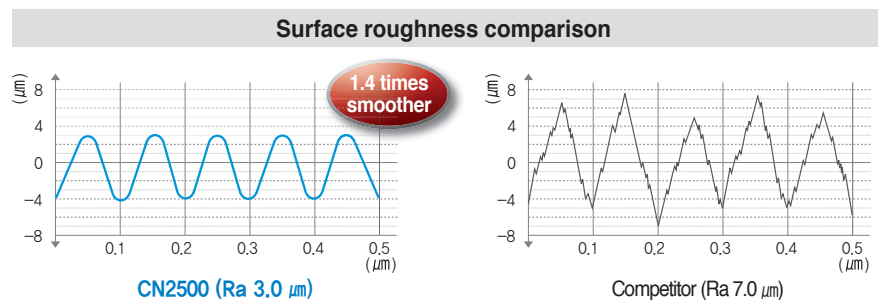
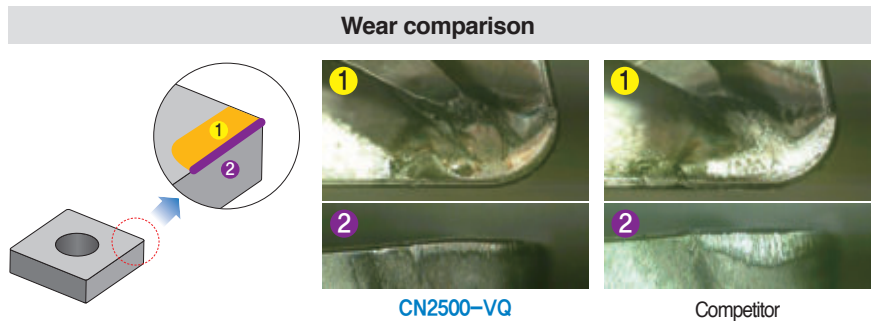


Features of VQ chip breaker

- Three dimensional rake angle
 - Improved surface finish thanks to sharp cutting performance
 - Less cutting heat and longer tool life thanks to low cutting resistance
- Beveled protruding structure
 - Smooth chip flow at low depth of cuts
 - Wide application range

Performance evaluation

- **Workpiece** SCM440(Alloy steel), Ø100, External diameter turning
- **Cutting conditions** $vc = 280 \text{ m/min}$, $ap = 1.5 \text{ mm}$, $fn = 0.25 \text{ mm/rev}$
- **Tools** CNMG120408-VQ (CN2500)



Features of Chip Breaker

VH/VT Chip Breaker [For heavy duty machining]

- Heavy duty chip breaker suitable for Heavy machining in the ship building and power plant industries
- Suitable for large vertical machines when machining shafts, rollers, rotors and optimal for the big flange machining

Features of VH chip breaker

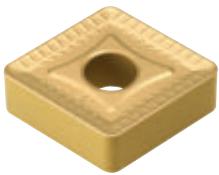
► For good chip control in heavy machining (comprehensive type)



- Designed from the study of heavy cutting mechanism
- Smooth chip control from the high rake angle
- Wider cutting edge land provides stronger cutting
- Unique cutting edge treatment provides smooth cutting
- Optimized chip pocket design provides smooth chip flow

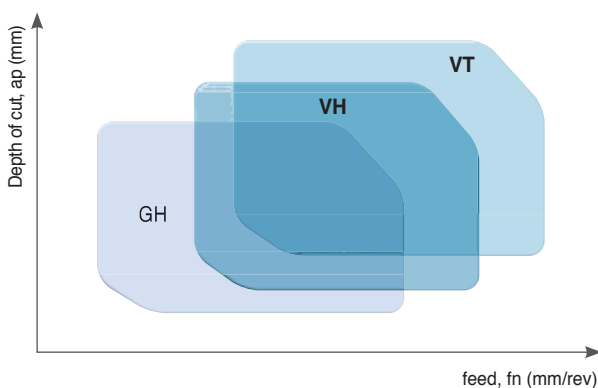
Features of VT chip breaker

► For long tool life and stable cutting (higher feeds, big depth) in heavy machining



- Designed from the study of heavy cutting mechanism
- Strong edge design provides long and stable cutting (2 step rake angle of cutting edge)
- Varied cutting edge land strengthens the cutting edge
- The positioning of the chip breaking convex dot deflect the machining heat, optimizes inserts wear & absorb shock

Applications range of chip breakers



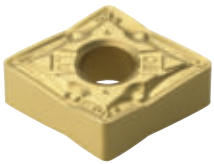
B Turning Chip Breakers

Features of Chip Breaker

LW/VW Chip Breaker [For high feed cutting]

- Improved productivity with higher feed rates and surface finishes
- Improved wear resistance and toughness

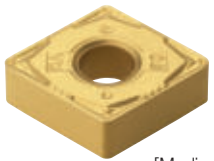
Features of LW chip breaker



[For medium cutting]

- **Curvilinear cutting edge** - Reduces cutting force
- **Cutting edge design able to handle deeper depth of cuts** - lower cutting load & reduces heat
- **Greater chip control at shallow depths of cuts** - Chip pocket design improves smooth chip flow
- **For shallow depth cutting and low speed machining** - 3D design at the corner

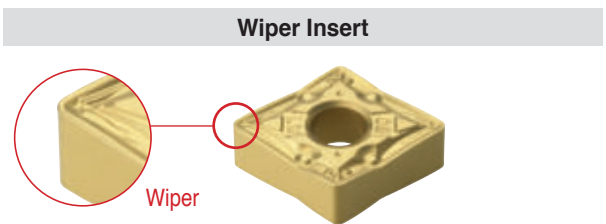
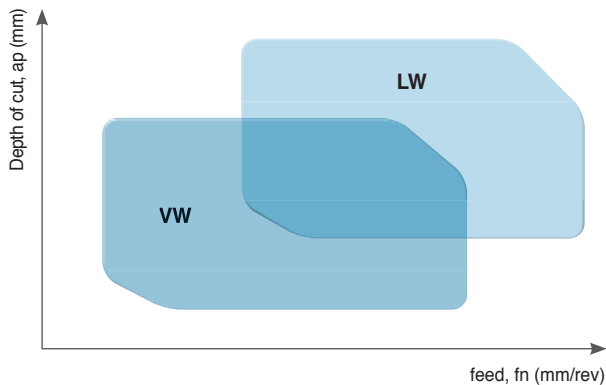
Features of VW chip breaker



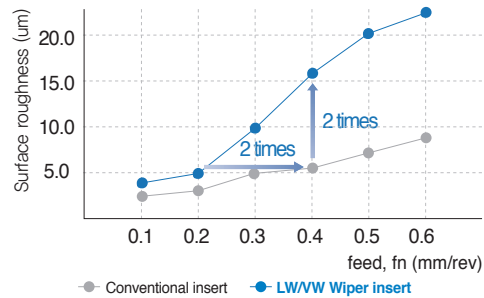
[Medium to finishing]

- **Excellent Finishing applications** - Excellent chip control
- **Insert design great for stable clamping** - Chip breaker designed close to the cutting edge
- **Similar cutting edge to C/B for medium** - strong cutting edge
- **3 Dimensional dot design on cutting corner** - reduces cutting force and good chip control at shallow depth of cut

Applications range of chip breakers



- High productivity
- Improved surface roughness
- High feed-reducing machining time
- Improved tool life due to reduce cutting force

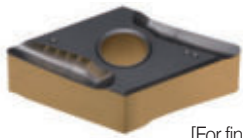


Features of Chip Breaker

SR/SH Chip Breaker new [For machining a shaft]

- Specialized for machining slender bars and thin walls
- High rake helix angle to reduce cutting resistance
- For machining steel and stainless steel

Features of SR chip breaker



[For finishing]

- The first recommended chip breaker for machining a shaft
- For continuous finishing
- Improved chip and heat evacuation due to high rake cutting edge and 3-dimensional shape
- Good surface finish
- Preventing fracture due to chamfering on the cutting edge

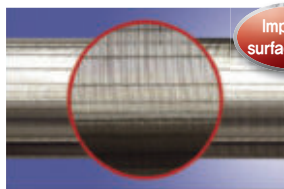
Features of SH chip breaker



[For medium cutting]

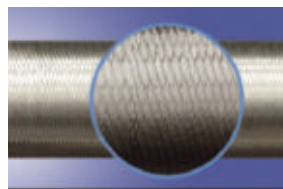
- Specialized for interrupted and medium cutting
- Efficient heat evacuation due to concave shaped back side of insert

Surface finish evaluation



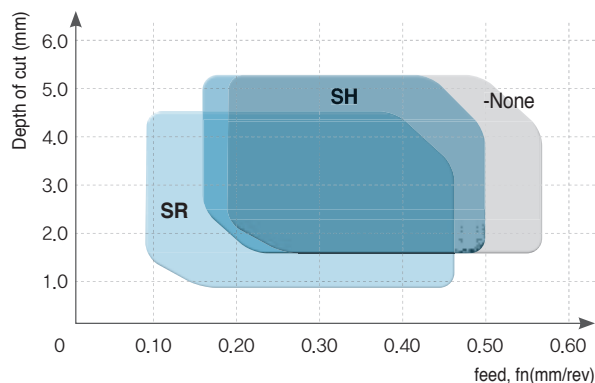
SR chip breaker

Improved surface finish



Other chip breakers

Applications range of chip breakers



Machining	C/B	a_p (mm)	f_n (mm/rev)
Medium to rough cutting	-None	1.5~5.0	0.20~0.55
Medium cutting	SH	1.5~5.0	0.15~0.50
Finish cutting	SR	1.0~4.5	0.12~0.45

B Turning Insert Code System (ISO)



1 Insert Shape

C N M G 12 04 08 - MP

C D E K L
R S T V W

2 Relief Angle

C N M G 12 04 08 - MP

B C D E
F N P O

3 Tolerance

C N M G 12 04 08 - MP

d: Inscribed circle
t: Thickness
m: Refer to figure

Class	d	m	t
A	±0.025	±0.005	±0.025
C	±0.025	±0.013	±0.025
H	±0.013	±0.013	±0.025
E	±0.025	±0.025	±0.025
G	±0.025	±0.025	±0.13
J*	±0.05~±0.15	±0.005	±0.025
K*	±0.05~±0.15	±0.013	±0.025
L*	±0.05~±0.15	±0.025	±0.025
M*	±0.05~±0.15	±0.08~±0.20	±0.13
N*	±0.05~±0.15	±0.08~±0.18	±0.025
U*	±0.08~±0.25	±0.13~±0.38	±0.13

(mm)

* Sides are based on unground insert

Tolerance on C, H, R, T, W Insert Shape (Exceptional case)

d	Tolerance on d		Tolerance on m	
	J, K, L, M, N	U	M, N	U
6.35	±0.05	±0.08	±0.08	±0.13
9.525	±0.05	±0.08	±0.08	±0.13
12.7	±0.08	±0.13	±0.13	±0.20
15.875	±0.10	±0.18	±0.15	±0.27
19.05	±0.10	±0.18	±0.15	±0.27
25.4	±0.13	±0.25	±0.18	±0.38

Tolerance on D Insert Shape (Exceptional case)

d	Tolerance on d	Tolerance on m
6.35	±0.05	±0.11
9.525	±0.05	±0.11
12.7	±0.08	±0.15
15.875	±0.10	±0.18
19.05	±0.10	±0.18

4 Cross Section Type

C N M G 12 04 08 - MP

A B C
F G H
J M N
Q R T
U W X



04

08

-

MP

6

7

8

Height of Cutting Edge

Nose "r"

Chip Breaker for Turning

5 Cutting Edge Length, Diameter of Incribed Circle
C N M G 12 04 08 - MP

Symbol							Inch	IC d (mm)
C	d	S	T	R	V	W		
03	04	03	06	03	-	02	1.2 (5)	3.97
04	05	04	08	04	08	S3	1.5 (6)	4.76
05	06	05	09	05	09	03	1.8 (7)	5.56
-	-	-	-	06	-	-	-	6.00
06	07	06	11	06	11	04	2	6.35
08	09	07	13	07	13	05	2.5	7.94
-	-	-	-	08	-	-	-	8.00
09	11	09	16	09	16	06	3	9.525
-	-	-	-	10	-	-	-	10.00
11	13	11	19	11	19	07	3.5	11.11
-	-	-	-	12	-	-	-	12.00
12	15	12	22	12	22	08	4	12.70
14	17	14	24	14	24	09	4.5	14.29
16	19	15	27	15	27	10	5	15.875
-	-	-	-	16	-	-	-	16.00
17	21	17	30	17	30	11	5.5	17.46
19	23	19	33	19	33	13	6	19.05
-	-	-	-	20	-	-	-	20.00
22	27	22	38	22	38	15	7	22.225
-	-	-	-	25	-	-	-	25.00
25	31	25	44	25	44	17	8	25.40
32	38	31	54	31	54	21	10	31.75
-	-	-	-	32	-	-	-	32.00

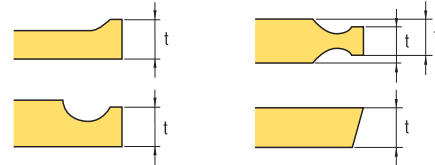
() Symbol for small size insert

7 Nose "r"
C N M G 12 04 08 - MP



Symbol		Nose "r"	
Metric	Inch	Metric	Inch
003	0.1	0.03	0.0012
005	0.13	0.05	0.002
01	0.2	0.1	0.004
02	0.5	0.2	0.008
04	1	0.4	1/64
08	2	0.8	1/32
12	3	1.2	3/64
16	4	1.6	1/16
20	5	2.0	5/64
24	6	2.4	3/32
28	7	2.8	7/64
32	8	3.2	1/8
00	-	Round insert (Inch)	
M0	-	Round insert (Metric)	

6 Height of Cutting Edge
C N M G 12 04 08 - MP

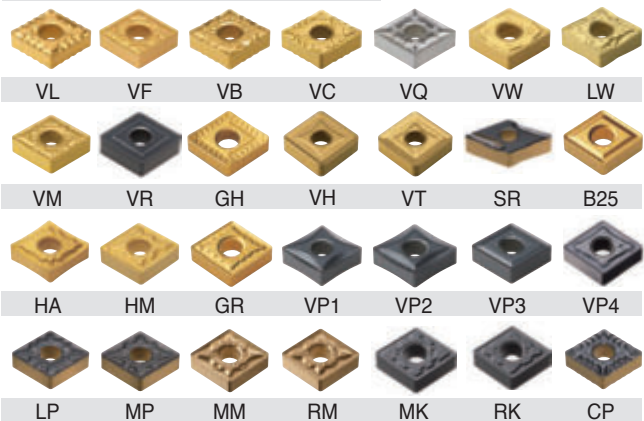


Symbol		Height of Cutting Edge (t)	
Metric	Inch	mm	Inch
01	1 (2)	1.59	1/16
T0	1.125	1.79	9/128
T1	1.2	1.98	5/64
02	1.5 (3)	2.38	3/32
T2	1.75	2.78	7/64
03	2	3.18	1/8
T3	2.5	3.97	5/32
04	3	4.76	3/16
05	3.5	5.56	7/32
06	4	6.35	1/4
07	5	7.94	5/16
09	6	9.52	3/8
11	7	11.11	7/16
12	8	12.70	1/2

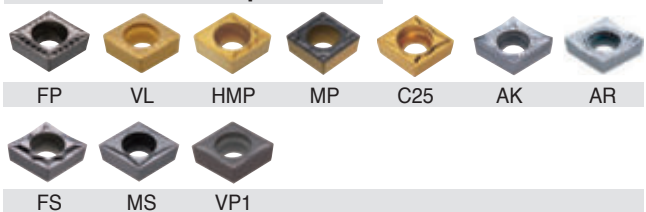
() Symbol for small size insert

8 Chip Breaker for Turning
C N M G 12 04 08 - MP

Negative Insert Chip Breaker

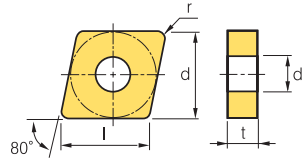


Positive Insert Chip Breaker



B Turning Insert (Negative)

CN



Dimensions (mm)			
Size	d	t	d ₁
09	9.525	3.18	3.81
12	12.7	4.76	5.16
16	15.875	6.35	6.35

Rhombic **80° Negative**

Workpiece	Machining types																						
	P	M	K	N	S	H	NC3215P	NC3225P	NC3215	NC3225	NC3120	NC3030	NC3235	NC5330	NC6310	NC6315	NC9115	NC9125	NC9135	PC8105	PC8110	PC8115	PC9030
Steel	●	●	●	●	●	●	●	●	●	●	●	●	●	●	●	●	●	●	●	●	●	●	●
Stainless steel	●	●	●	●	●	●	●	●	●	●	●	●	●	●	●	●	●	●	●	●	●	●	●
Cast iron	●	●	●	●	●	●	●	●	●	●	●	●	●	●	●	●	●	●	●	●	●	●	●
Non-ferrous metal	●	●	●	●	●	●	●	●	●	●	●	●	●	●	●	●	●	●	●	●	●	●	●
Heat resistant alloy, Titanium alloy	●	●	●	●	●	●	●	●	●	●	●	●	●	●	●	●	●	●	●	●	●	●	●
Hardened steel	●	●	●	●	●	●	●	●	●	●	●	●	●	●	●	●	●	●	●	●	●	●	●

Inserts	Designation	Cermet		Coated		Coated													Uncoated		Cutting Condition							
		CN1500	CN2500	CC1500	CC2500	NC3215P	NC3225P	NC3215	NC3225	NC3120	NC3030	NC3235	NC5330	NC6310	NC6315	NC9115	NC9125	NC9135	PC8105	PC8110	PC8115	PC9030	H01	H05	f _n (mm/rev)	a _p (mm)		
Finishing		CNMG 120404-VB	●	●	●	●		●	●				●													0.15~0.35	0.30~2.00	
		120408-VB	●	●	●	●		●	●				●														0.15~0.45	0.50~2.00
		120412-VB						●	●				●														0.20~0.50	0.50~2.00
Finishing		CNMG 090304-VF							●	●																0.07~0.30	0.50~1.50	
		090308-VF																									0.10~0.30	0.50~1.50
		120404-VF								●			●														0.07~0.30	0.50~1.50
		120408-VF											●														0.10~0.40	0.50~1.50
		120412-VF																										0.10~0.50
Finishing		CNMG 120404-VL	●	●									●													0.05~0.25	0.10~1.00	
		120408-VL	●	●					●	●			●														0.10~0.35	0.20~1.50
		120412-VL							●																		0.10~0.35	0.20~1.50
Medium to finishing		CNMG 090304-LP																								0.07~0.30	0.30~1.50	
		090308-LP							●	●																	0.10~0.30	0.30~1.50
		120404-LP							●	●			●														0.10~0.35	0.30~2.00
		120408-LP							●	●			●														0.10~0.40	0.50~2.50
		120412-LP							●	●			●														0.13~0.45	0.80~3.00
Medium to finishing		CNMG 090304-CP																								0.08~0.30	0.40~3.00	
		090308-CP																									0.10~0.30	0.40~3.00
		090404-CP																									0.08~0.30	0.40~3.00
		090408-CP																									0.10~0.30	0.40~3.00
		120404-CP						●	●																		0.10~0.35	0.50~3.50
		120408-CP						●	●																		0.12~0.35	0.50~3.50
		120412-CP						●	●																		0.13~0.35	0.80~3.50
		160608-CP						●	●																		0.15~0.40	0.80~4.50
160612-CP						●	●																		0.18~0.40	1.00~4.50		
Medium to finishing		CNMG 120404-VC						●	●			●														0.10~0.35	0.30~2.00	
		120408-VC						●	●			●														0.15~0.40	0.50~3.00	
		120412-VC						●	●																	0.15~0.45	0.50~3.00	

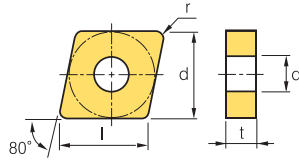
Cutting edge geometry **A37~A49**
 Recommended chip breaker **B04~B15**
 Code system **B34~B35**
● : Stock item

Available tool holders			
Designation	Page	Designation	Page
MCKNR/L	B183	MCRNR/L	B184
MCLNR/L	B183	PCBNR/L	B172
MCMNN	B183	PCLNR/L	B173



CN

Rhombic 80° Negative



Dimensions (mm)			
Size	d	t	d ₁
09	9.525	3.18	3.81
12	12.7	4.76	5.16
16	15.875	6.35	6.35
19	19.05	6.35	7.93

Workpiece	Steel	P	●	*	●	●	●	●	●	●	●	●	●	●	●	●	●	●	●	●	●	●	●	●	●	Machining types		
	Stainless steel	M	●	*	●	●	●	●	●	●	●	●	●	●	●	●	●	●	●	●	●	●	●	●	●	●	●	●
Cast iron	K	●	*	●	●	●	●	●	●	●	●	●	●	●	●	●	●	●	●	●	●	●	●	●	●	●	●	●
Non-ferrous metal	N	●	*	●	●	●	●	●	●	●	●	●	●	●	●	●	●	●	●	●	●	●	●	●	●	●	●	●
Heat resistant alloy, Titanium alloy	S	●	*	●	●	●	●	●	●	●	●	●	●	●	●	●	●	●	●	●	●	●	●	●	●	●	●	●
Hardened steel	H	●	*	●	●	●	●	●	●	●	●	●	●	●	●	●	●	●	●	●	●	●	●	●	●	●	●	●

● Continuous cutting
 ● General cutting
 * Interrupted cutting

Inserts	Designation	Cermet		Coated		Coated										Uncoated		Cutting Condition										
		CN1500	CN2500	CC1500	CC2500	NC3215	NC3225	NC3120	NC3030	NC3235	NC5330	NC6310	NC6315	NC9115	NC9125	NC9135	PC5300	PC5400	PC8105	PC8110	PC8115	PC9030	H01	H05	f _n (mm/rev)	a _p (mm)		
Medium cutting HM	CNMG 090304-HM																									0.12~0.40	0.50~3.80	
	090308-HM																										0.15~0.40	0.80~3.80
	120404-HM							●	●	●												●				0.05~0.30	0.90~5.00	
	120408-HM							●	●	●						●						●				0.10~0.50	1.00~5.00	
	120412-HM							●														●				0.18~0.50	1.00~5.00	
	190612-HM									●																	0.13~0.60	1.30~7.00
Medium cutting MP	CNMG 090304-MP					●	●								●											0.10~0.40	0.40~3.80	
	090308-MP					●	●								●											0.15~0.40	0.50~4.00	
	090312-MP																									0.15~0.50	0.80~4.20	
	090404-MP																									0.10~0.40	0.40~3.80	
	090408-MP																									0.15~0.40	0.50~4.00	
	090412-MP																									0.15~0.50	0.80~4.20	
	120404-MP					●	●				●	●			●	●	●			●	●	●				0.10~0.40	0.40~4.00	
	120408-MP					●	●		●		●	●			●	●	●			●	●	●				0.15~0.45	0.50~4.50	
	120412-MP					●	●				●	●			●	●	●			●	●					0.15~0.50	0.80~5.00	
	120416-MP					●	●				●	●			●	●	●									0.28~0.55	1.00~5.00	
	160608-MP					●	●				●	●			●	●	●									0.15~0.50	0.50~7.00	
	160612-MP					●	●				●	●			●	●	●									0.18~0.60	0.80~7.00	
	160616-MP					●	●				●	●			●	●	●									0.15~0.60	1.00~7.00	
	190608-MP								●																	0.15~0.60	0.50~8.50	
190612-MP									●																0.10~0.40	0.40~3.80		
190616-MP										●					●	●	●									0.15~0.40	0.50~4.00	
Medium cutting VM	CNMG 090304-VM									●	●															0.05~0.30	0.90~3.50	
	090308-VM									●	●															0.10~0.45	1.00~3.50	
	120404-VM	●	●							●	●				●	●					●				0.05~0.30	0.90~5.00		
	120408-VM	●	●							●	●				●	●					●				0.10~0.50	1.00~5.00		
	120412-VM									●	●				●	●					●				0.13~0.60	1.30~5.00		
	120416-VM										●														0.20~0.60	1.50~5.50		
	160608-VM										●														0.10~0.50	1.00~6.70		
	160612-VM											●													0.13~0.60	1.30~6.70		
	190608-VM										●														0.13~0.65	1.30~7.00		
	190612-VM											●													0.15~0.70	1.50~7.00		
190616-VM																									0.18~0.75	1.80~7.00		

Cutting edge geometry A37~A49
 Recommended chip breaker B04~B15
 Code system B34~B35
 ● : Stock item

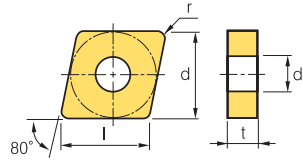
Available tool holders			
Designation	Page	Designation	Page
MCKNR/L	B183	MCRNR/L	B184
MCLNR/L	B183	PCBNR/L	B172
MCMNN	B183	PCLNR/L	B173



B Turning Insert (Negative)





CN ○ ○

Rhombic 80° Negative



Dimensions (mm)			
Size	d	t	d ₁
09	9.525	3.18	3.81
12	12.7	4.76	5.16
16	15.875	6.35	6.35
19	19.05	6.35	7.93
25	25.4	9.52	9.12

Workpiece	Material												Machining types				
	Steel	Stainless steel	Cast iron	Non-ferrous metal	Heat resistant alloy, Titanium alloy	Hardened steel	P	M	K	N	S	H	●	⊙	⊙	⊙	
Steel							●	⊙	⊙	⊙	⊙	⊙	⊙	⊙	⊙	⊙	⊙
Stainless steel		●	⊙	⊙	⊙	⊙	⊙	⊙	⊙	⊙	⊙	⊙	⊙	⊙	⊙	⊙	⊙
Cast iron			●	⊙	⊙	⊙	⊙	⊙	⊙	⊙	⊙	⊙	⊙	⊙	⊙	⊙	⊙
Non-ferrous metal				●	⊙	⊙	⊙	⊙	⊙	⊙	⊙	⊙	⊙	⊙	⊙	⊙	⊙
Heat resistant alloy, Titanium alloy					●	⊙	⊙	⊙	⊙	⊙	⊙	⊙	⊙	⊙	⊙	⊙	⊙
Hardened steel																	

Inserts	Designation	Cermet		Coated										Uncoated		Cutting Condition											
		CN1500	CN2500	CC1500	CC2500	NC3215	NC3225	NC3120	NC3030	NC3235	NC5330	NC6310	NC6315	NC9115	NC9125	NC9135	PC5300	PC5400	PC8105	PC8110	PC8115	PC9030	H01	H05	f _n (mm/rev)	a _p (mm)	
Medium to roughing 	CNMG 120404-B25	●	●			●	●	●	●	●	●	●	●	●	●	●	●	●	●	●	●	●	●	●	●	0.17~0.45	1.00~5.00
	120408-B25	●	●			●	●	●	●	●	●	●	●	●	●	●	●	●	●	●	●	●	●	●	●	0.23~0.60	1.50~5.00
	120412-B25		●			●	●	●	●	●	●	●	●	●	●	●	●	●	●	●	●	●	●	●	●	0.25~0.60	2.00~5.00
	160608-B25					●	●	●	●	●	●	●	●	●	●	●	●	●	●	●	●	●	●	●	●	0.25~0.60	2.00~6.50
	160612-B25					●	●	●	●	●	●	●	●	●	●	●	●	●	●	●	●	●	●	●	●	0.27~0.60	2.00~6.50
	160616-B25					●	●	●	●	●	●	●	●	●	●	●	●	●	●	●	●	●	●	●	●	0.27~0.60	2.00~6.50
	190604-B25								●	●	●	●	●	●	●	●	●	●	●	●	●	●	●	●	●	0.20~0.45	3.00~8.00
	190608-B25					●	●	●	●	●	●	●	●	●	●	●	●	●	●	●	●	●	●	●	●	0.25~0.60	3.00~8.00
	190612-B25					●	●	●	●	●	●	●	●	●	●	●	●	●	●	●	●	●	●	●	●	0.30~0.60	3.00~8.00
	190616-B25					●	●	●	●	●	●	●	●	●	●	●	●	●	●	●	●	●	●	●	●	0.23~0.70	3.00~8.00
Roughing 	CNMG 120408-GR					●	●	●	●	●	●	●	●	●	●	●	●	●	●	●	●	●	●	●	●	0.20~0.50	1.00~7.00
	120412-GR						●	●	●	●	●	●	●	●	●	●	●	●	●	●	●	●	●	●	●	0.25~0.50	1.30~7.00
	120416-GR							●	●	●	●	●	●	●	●	●	●	●	●	●	●	●	●	●	●	0.25~0.60	1.80~6.00
	160608-GR					●	●	●	●	●	●	●	●	●	●	●	●	●	●	●	●	●	●	●	●	0.20~0.70	1.00~8.00
	160612-GR					●	●	●	●	●	●	●	●	●	●	●	●	●	●	●	●	●	●	●	●	0.25~0.70	1.30~8.00
	160616-GR					●	●	●	●	●	●	●	●	●	●	●	●	●	●	●	●	●	●	●	●	0.25~0.75	1.80~8.00
	190608-GR							●	●	●	●	●	●	●	●	●	●	●	●	●	●	●	●	●	●	0.20~0.70	1.70~10.00
	190612-GR					●	●	●	●	●	●	●	●	●	●	●	●	●	●	●	●	●	●	●	●	0.30~0.75	1.70~10.00
	190616-GR					●	●	●	●	●	●	●	●	●	●	●	●	●	●	●	●	●	●	●	●	0.30~0.80	1.80~10.00
	190624-GR																									0.35~0.85	2.00~12.00
	250724-GR																										0.40~1.00
250924-GR								●	●	●	●	●	●	●	●	●	●	●	●	●	●	●	●	●	●	0.40~1.00	2.30~15.00
Medium to finishing  [Cermet]	CNMG 090304-VQ																									0.05~0.30	0.50~3.50
	090308-VQ																									0.08~0.30	0.80~4.00
	090408-VQ																									0.05~0.30	0.50~3.50
	090412-VQ																									0.08~0.30	0.80~4.00
	120404-VQ																									0.05~0.30	0.80~4.00
	120408-VQ	●	●	●	●																					0.08~0.40	0.80~4.00
	120412-VQ	●	●	●	●																					0.10~0.40	0.80~4.00
Medium cutting 	CNMG 120404-MK																									0.05~0.30	0.90~4.00
	120408-MK																									0.10~0.50	1.00~5.00
	120412-MK																									0.13~0.60	1.30~5.00
	120416-MK																									0.15~0.60	1.30~5.00
	160608-MK																									0.28~0.70	1.80~7.00
	160612-MK																									0.28~0.72	2.00~8.00
	160616-MK																									0.28~0.74	2.00~8.00
	190608-MK																									0.33~0.78	2.50~9.00
	190612-MK																									0.35~0.78	2.60~9.50
	190616-MK																									0.35~0.80	2.60~10.00

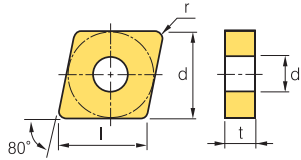
Cutting edge geometry A37~A49
 Recommended chip breaker B04~B15
 Code system B34~B35
 ● : Stock item

Available tool holders			
Designation	Page	Designation	Page
MCKNR/L	B183	MCRNR/L	B184
MCLNR/L	B183	PCBNR/L	B172
MCMNN	B183	PCLNR/L	B173



CN

Rhombic 80° Negative



Dimensions (mm)			
Size	d	t	d ₁
09	9.525	3.18	3.81
12	12.7	4.76	5.16
16	15.875	6.35	6.35
19	19.05	6.35	7.93

Workpiece	Material Compatibility													Machining types				
	Steel	Stainless steel	Cast iron	Non-ferrous metal	Heat resistant alloy, Titanium alloy	Hardened steel	P	M	K	N	S	H	●	●	●	●	●	●
Steel	●	●	●	●	●	●	●	●	●	●	●	●	●	●	●	●	●	●
Stainless steel	●	●	●	●	●	●	●	●	●	●	●	●	●	●	●	●	●	●
Cast iron	●	●	●	●	●	●	●	●	●	●	●	●	●	●	●	●	●	●
Non-ferrous metal	●	●	●	●	●	●	●	●	●	●	●	●	●	●	●	●	●	●
Heat resistant alloy, Titanium alloy	●	●	●	●	●	●	●	●	●	●	●	●	●	●	●	●	●	●
Hardened steel	●	●	●	●	●	●	●	●	●	●	●	●	●	●	●	●	●	●

Inserts	Designation	Cermet		Coated		Coated										Uncoated		Cutting Condition												
		CN1500	CN2500	CC1500	CC2500	NC3215	NC3225	NC3120	NC3030	NC3235	NC5330	NC6310	NC6315	NC9115	NC9125	NC9135	PC5300	PC5400	PC8105	PC8110	PC8115	PC9030	H01	H05	f _n (mm/rev)	a _p (mm)				
Roughing		CNMA 090308																								0.10~0.30	0.50~3.00			
		120404										●														●	0.15~0.60	1.00~5.00		
		120408										●	●													●	0.15~0.60	1.00~6.00		
		120412										●	●														●	0.15~0.70	1.50~6.00	
		120416										●	●														●	0.20~0.80	2.00~6.00	
		160608																										●	0.15~0.70	2.00~6.00
		160612												●														●	0.15~0.70	2.00~6.00
		160616												●														●	0.15~0.70	2.00~6.00
		190608												●														●	0.15~0.70	2.00~10.00
		190612												●														●	0.15~0.70	2.00~10.00
190616												●	●													●	0.20~1.00	3.00~10.00		
Roughing		CNMG 120404-RK																									●	0.20~0.47	1.30~6.00	
		120408-RK										●	●														●	0.20~0.50	1.50~6.00	
		120412-RK										●	●														●	0.28~0.53	1.80~6.00	
		120416-RK											●														●	0.28~0.63	2.00~6.00	
		160608-RK											●														●	0.28~0.70	1.80~7.00	
		160612-RK											●	●													●	0.28~0.72	2.00~8.00	
		160616-RK											●														●	0.28~0.74	2.00~8.00	
		190612-RK												●													●	0.35~0.78	2.60~9.50	
		190616-RK												●													●	0.35~0.80	2.60~10.00	
Roughing		CNMG 120404-VR																									●	0.20~0.50	1.00~6.50	
		120408-VR																									●	0.25~0.55	1.20~7.00	
		120412-VR																									●	0.30~0.60	1.50~7.00	
		120416-VR																									●	0.35~0.65	1.70~7.00	
		120508-VR																									●	0.25~0.55	1.20~7.00	
		120512-VR																									●	0.30~0.60	1.50~7.00	
		160612-VR																									●	0.35~0.70	2.00~8.00	
		160616-VR																									●	0.35~0.75	2.20~8.00	
		190612-VR									●	●															●	0.35~0.70	2.00~10.00	
		190616-VR									●	●															●	0.35~0.75	2.20~10.00	

➤ Cutting edge geometry **A37~A49**
 ➤ Recommended chip breaker **B04~B15**
 ➤ Code system **B34~B35**
 ● : Stock item

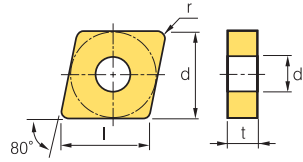
Available tool holders			
Designation	Page	Designation	Page
MCKNR/L	B183	MCRNR/L	B184
MCLNR/L	B183	PCBNR/L	B172
MCMNN	B183	PCLNR/L	B173



B Turning Insert (Negative)



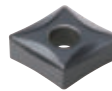

CN○○○

 Rhombic **80° Negative**



Dimensions (mm)			
Size	d	t	d ₁
09	9.525	3.18	3.81
12	12.7	4.76	5.16
16	15.875	6.35	6.35
19	19.05	6.35	7.93
25	25.4	9.52	9.12

Workpiece	Material Compatibility																Machining types				
	Steel	Stainless steel	Cast iron	Non-ferrous metal	Heat resistant alloy, Titanium alloy	Hardened steel	P	M	K	N	S	H	●	⊕	⊖	⊗	⊙	⊚	⊛	⊜	
Steel	●	●	●	●	●	●	●	●	●	●	●	●	●	●	●	●	●	●	●	●	●
Stainless steel	●	●	●	●	●	●	●	●	●	●	●	●	●	●	●	●	●	●	●	●	●
Cast iron	●	●	●	●	●	●	●	●	●	●	●	●	●	●	●	●	●	●	●	●	●
Non-ferrous metal	●	●	●	●	●	●	●	●	●	●	●	●	●	●	●	●	●	●	●	●	●
Heat resistant alloy, Titanium alloy	●	●	●	●	●	●	●	●	●	●	●	●	●	●	●	●	●	●	●	●	●
Hardened steel	●	●	●	●	●	●	●	●	●	●	●	●	●	●	●	●	●	●	●	●	●

Inserts	Designation	Cermet		Coated		Coated										Uncoated		Cutting Condition										
		CN1500	CN2500	CC1500	CC2500	NC3215	NC3225	NC3120	NC3030	NC3235	NC5330	NC6310	NC6315	NC9115	NC9125	NC9135	PC5300	PC5400	PC8105	PC8110	PC8115	PC9030	H01	H05	f _n (mm/rev)	a _p (mm)		
Medium cutting 	CNMG 090304-MM																									0.08-0.35	0.50-5.00	
	090308-MM													●	●											0.10-0.40	0.50-5.00	
	090312-MM																									0.12-0.45	0.50-5.00	
	090404-MM																									0.08-0.35	0.50-5.00	
	090408-MM																									0.10-0.40	0.50-5.00	
	090412-MM																									0.12-0.45	0.50-5.00	
	120404-MM													●	●	●				●	●	●				0.10-0.40	0.50-5.50	
	120408-MM													●	●	●	●			●	●	●				0.12-0.45	0.50-5.50	
	120412-MM													●	●	●	●			●	●	●				0.15-0.60	0.50-5.50	
	120416-MM													●	●	●				●						0.20-0.65	0.50-5.50	
	160608-MM													●	●	●				●						0.12-0.45	0.50-7.00	
	160612-MM													●	●	●				●		●				0.15-0.60	0.50-7.00	
	160616-MM													●	●	●				●		●				0.18-0.65	0.50-7.00	
	190608-MM													●	●	●				●						0.12-0.45	0.50-8.50	
	190612-MM													●	●	●				●		●				0.15-0.60	0.50-8.50	
190616-MM													●	●	●				●		●				0.18-0.65	0.50-8.50		
Roughing 	CNMG 120404-RM													●	●	●				●	●					0.10-0.50	2.00-6.00	
	120408-RM													●	●	●	●			●	●	●				0.15-0.55	2.00-6.00	
	120412-RM													●	●	●	●			●	●	●				0.20-0.60	2.00-6.00	
	120416-RM													●	●	●				●						0.25-0.70	2.00-6.00	
	160608-RM													●	●	●				●						0.15-0.55	2.00-8.00	
	160612-RM													●	●	●				●						0.20-0.60	2.00-8.00	
	160616-RM													●	●	●				●						0.25-0.70	2.00-8.00	
	190608-RM													●	●	●				●						0.15-0.55	2.00-10.00	
	190612-RM													●	●	●				●							0.20-0.60	2.00-10.00
	190616-RM													●	●	●				●							0.25-0.70	2.00-10.00
250924-RM																										0.40-1.20	4.00-14.00	
Finishing 	CNMG 120404-VP1																		●	●			●			0.05-0.15	0.10-1.50	
	120408-VP1																			●	●			●			0.07-0.20	0.10-1.50
Finishing 	CNGG 120402-VP1																									0.01-0.10	0.10-1.00	
	120404-VP1																										0.05-0.15	0.10-1.50
	120408-VP1																										0.07-0.20	0.10-1.50

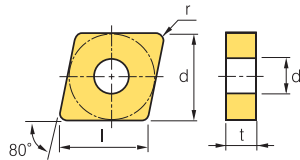
 Cutting edge geometry **A37~A49**
 Recommended chip breaker **B04~B15**
 Code system **B34~B35**
● : Stock item

Available tool holders			
Designation	Page	Designation	Page
MCKNR/L	B183	MCRNR/L	B184
MCLNR/L	B183	PCBNR/L	B172
MCMNN	B183	PCLNR/L	B173



CN ○ ○ ○

Rhombic 80° Negative



Dimensions (mm)			
Size	d	t	d1
12	12.7	4.76	5.16
16	15.875	6.35	6.35
19	19.05	6.35	7.93

Workpiece	Steel	P	●	*	●	●	●	●	●	●	●	●	●	●	●	●	●	Machining types	
	Stainless steel		M	●	*	●	●	●	●	●	●	●	●	●	●	●	●	●	●
Cast iron		K	●	*	●	●	●	●	●	●	●	●	●	●	●	●	●		
Non-ferrous metal		N	●		●	●	●	●	●	●	●	●	●	●	●	●	●	●	
Heat resistant alloy, Titanium alloy		S			●					●	●	●	●	●	●	●	●	●	
Hardened steel		H								●	●	●	●	●	●	●	●	●	

Inserts	Designation	Cermet		Coated		Coated										Uncoated		Cutting Condition										
		CN1500	CN2500	CC1500	CC2500	NC3215	NC3225	NC3120	NC3030	NC3235	NC5330	NC6315	NC9115	NC9125	NC9135	PC5300	PC5400	PC8105	PC8110	PC8115	PC8120	PC9030	H01	H05	fn (mm/rev)	ap (mm)		
Medium to finishing	VP2	CNMG	120404-VP2				●								●	●	●	●	●			●	●	0.05~0.30	0.10~3.00			
			120408-VP2													●	●	●	●	●			●	●	0.10~0.40	0.50~4.50		
			160608-VP2																							0.12~0.45	0.80~5.00	
			190608-VP2																							0.12~0.50	1.00~5.20	
			190612-VP2																								0.15~0.50	1.20~5.50
			190616-VP2																								0.18~0.50	1.50~5.50
Medium cutting	VP3	CNMG	120404-VP3												●	●	●	●	●				●	●	0.05~0.30	0.10~3.00		
			120408-VP3													●	●	●	●	●				●	●	0.10~0.40	0.50~4.50	
			120412-VP3													●	●	●	●	●					●	●	0.12~0.50	0.50~5.00
			120416-VP3																								0.25~0.45	1.00~4.00
			160608-VP3																								0.15~0.35	0.80~6.00
			160612-VP3																								0.20~0.40	1.00~6.00
			160616-VP3																								0.20~0.40	1.00~6.00
			190608-VP3																								0.20~0.50	1.00~7.00
			190612-VP3																								0.25~0.55	1.00~8.00
	190616-VP3																								0.30~0.60	1.00~8.00		
Medium cutting	VP3	CNGG	120404-VP3																						0.05~0.30	0.10~3.00		
			120408-VP3																							0.10~0.40	0.50~4.50	
			120412-VP3																							0.12~0.50	0.50~5.00	
Roughing	VP4 <small>new</small>	CNMG	120408-VP4																●	●					0.15~0.35	1.00~4.00		
			120412-VP4																●	●						0.20~0.40	1.00~4.00	
			160608-VP4																								0.20~0.45	1.00~6.50
			160612-VP4																								0.25~0.50	1.50~6.50
			190608-VP4																	●	●						0.15~0.45	1.00~8.00
			190612-VP4																	●	●						0.20~0.50	1.20~8.50
Medium to finishing	HA	CNMG	120404-HA																					●	●	0.05~0.20	0.80~3.50	
			120408-HA																						●	●	0.10~0.40	0.80~3.50
			120412-HA																						●		0.13~0.55	0.80~3.50
Finishing	VW	CNMG	120404-VW																							0.10~0.30	0.50~3.00	
			120408-VW						●																		0.15~0.50	0.50~4.00
			120412-VW																								0.20~0.55	1.00~4.50

➤ Cutting edge geometry **A37~A49** ➤ Recommended chip breaker **B04~B15** ➤ Code system **B34~B35** ● : Stock item

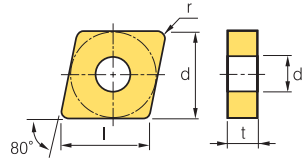
Available tool holders			
Designation	Page	Designation	Page
MCKNR/L	B183	MCRNR/L	B184
MCLNR/L	B183	PCBNR/L	B172
MCMNN	B183	PCLNR/L	B173



B Turning Insert (Negative)

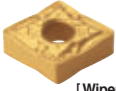



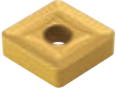
CN ○ ○

Rhombic 80° Negative



Dimensions (mm)			
Size	d	t	d ₁
12	12.7	4.76	5.16
16	15.875	4.76~6.35	6.35
19	19.05	6.35	7.93
25	25.4	7.94~9.52	9.12

Workpiece	Material	Grade	Machining types																				
			●	●	●	●	●	●	●	●	●	●	●	●	●	●	●	●	●	●	●	●	●
Steel		P	●	●	●	●	●	●	●	●	●	●	●	●	●	●	●	●	●	●	●	●	
Stainless steel		M	●	●	●	●	●	●	●	●	●	●	●	●	●	●	●	●	●	●	●	●	
Cast iron		K	●	●	●	●	●	●	●	●	●	●	●	●	●	●	●	●	●	●	●	●	
Non-ferrous metal		N	●	●	●	●	●	●	●	●	●	●	●	●	●	●	●	●	●	●	●	●	
Heat resistant alloy, Titanium alloy		S	●	●	●	●	●	●	●	●	●	●	●	●	●	●	●	●	●	●	●	●	
Hardened steel		H	●	●	●	●	●	●	●	●	●	●	●	●	●	●	●	●	●	●	●	●	

Inserts	Designation	Cermet		Coated		Coated														Uncoated		Cutting Condition					
		CN1500	CN2500	CC1500	CC2500	NC3215	NC3225	NC3120	NC3030	NC3235	NC5330	NC6310	NC6315	NC9115	NC9125	NC9135	PC5300	PC5400	PC8105	PC8110	PC8115	PC9030	HO1	HO5	f _n (mm/rev)	a _p (mm)	
Medium cutting  [Wiper]	CNMG 120408-LW					●	●				●				●										0.15~0.60	1.00~5.00	
	120412-LW					●	●								●											0.20~0.70	1.00~6.00
Medium cutting 	CNMM 120408-GR																								0.20~0.50	1.00~7.00	
	120412-GR																									0.25~0.50	1.30~7.00
	190612-GR								●																	0.30~0.75	1.70~10.00
	190616-GR																									0.30~0.80	1.80~10.00
Heavy 	CNMM 120408-GH					●	●				●														0.30~0.60	2.50~8.00	
	120412-GH					●	●	●																		0.30~0.70	2.50~8.00
	160412-GH																									0.30~0.70	2.50~8.00
	160424-GH																									0.30~1.20	2.50~8.00
	160612-GH								●																	0.30~0.90	2.50~8.00
	160616-GH																									0.30~1.20	2.50~8.00
	160624-GH																									0.30~1.50	2.50~8.00
	190608-GH										●															0.30~0.60	2.50~8.00
	190612-GH					●	●	●	●		●															0.30~0.70	3.00~8.00
	190616-GH					●	●	●	●		●															0.45~0.90	3.00~8.00
	190624-GH					●	●			●																0.55~1.20	4.00~9.00
	250716-GH																									0.50~1.00	4.50~10.00
250724-GH						●	●																		0.55~1.20	5.00~12.00	
250924-GH						●	●	●	●		●														0.55~1.20	5.00~12.00	
Heavy 	CNMM 190612-VH					●																			0.50~0.90	5.00~10.00	
	190616-VH					●																				0.50~1.10	5.00~10.00
	190624-VH					●																				0.60~1.20	6.00~12.00
	250724-VH					●																				0.70~1.40	6.00~15.00
	250924-VH					●																				0.70~1.40	6.00~15.00
Heavy  [High feed cutting]	CNMM 190612-VT					●		●	●																0.60~1.00	6.00~13.00	
	190616-VT					●																				0.60~1.10	5.00~10.00
	190624-VT					●																				0.60~1.60	7.00~13.00
	250724-VT					●																				0.75~16.0	7.00~17.00
	250924-VT					●																				0.75~16.0	7.00~17.00

🔄 Cutting edge geometry A37~A49

🔄 Recommended chip breaker B04~B15

🔄 Code system B34~B35

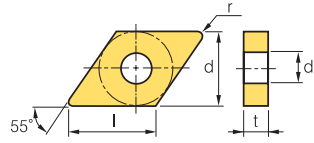
● : Stock item

Available tool holders			
Designation	Page	Designation	Page
MCKNR/L	B183	MCRNR/L	B184
MCLNR/L	B183	PCBNR/L	B172
MCMNN	B183	PCLNR/L	B173



B Turning Insert (Negative)

DN



Dimensions (mm)			
Size	d	t	d ₁
11	9.525	3.18~4.76	3.81
15	12.7	4.76~6.35	5.16

Rhombic **55° Negative**

Workpiece	Machining types															
	P	M	K	N	S	H										
Steel	●	●	●	●	●	●	●	●	●	●	●	●	●	●	●	●
Stainless steel	●	●	●	●	●	●	●	●	●	●	●	●	●	●	●	●
Cast iron	●	●	●	●	●	●	●	●	●	●	●	●	●	●	●	●
Non-ferrous metal	●	●	●	●	●	●	●	●	●	●	●	●	●	●	●	●
Heat resistant alloy, Titanium alloy	●	●	●	●	●	●	●	●	●	●	●	●	●	●	●	●
Hardened steel	●	●	●	●	●	●	●	●	●	●	●	●	●	●	●	●

Inserts	Designation	Cermets		Coated		Coated													Uncoated		Cutting Condition						
		CN1500	CN2500	CC1500	CC2500	NC3215P	NC3225P	NC3215	NC3225	NC3120	NC3030	NC3235	NC5330	NC6310	NC6315	NC9115	NC9125	NC9135	PC8105	PC8110	PC8115	PC9030	H01	H05	f _n (mm/rev)	a _p (mm)	
Medium to finishing 	DNMG 110404-CP																								0.08-0.30	0.40-3.00	
	110408-CP																									0.10-0.30	0.40-3.00
	110504-CP																									0.08-0.30	0.40-3.00
	110508-CP																									0.10-0.30	0.40-3.00
	150404-CP					●	●																			0.10-0.35	0.50-3.50
	150408-CP					●	●																			0.12-0.35	0.50-3.50
	150412-CP					●	●																			0.13-0.35	0.80-3.50
	150604-CP					●	●																			0.10-0.35	0.50-3.50
	150608-CP					●	●																			0.12-0.35	0.50-3.50
	150612-CP					●	●																			0.13-0.35	0.80-3.50
Medium to finishing 	DNMG 150404-VC							●	●																0.10-0.35	0.30-2.00	
	150408-VC							●	●			●														0.15-0.40	0.50-3.00
	150412-VC							●	●																	0.15-0.45	0.50-3.00
	150604-VC							●	●																	0.10-0.35	0.30-2.00
	150608-VC							●	●				●													0.15-0.40	0.50-3.00
	150612-VC							●	●																	0.15-0.45	0.50-3.00
Medium cutting 	DNMG 110404-HM												●												0.05-0.50	0.80-4.00	
	110408-HM																								0.10-0.50	1.00-4.00	
	150404-HM									●															0.05-0.30	0.90-5.00	
	150408-HM										●														0.10-0.50	1.00-5.00	
	150604-HM											●	●			●									0.05-0.30	0.90-5.00	
	150608-HM												●	●	●										0.10-0.50	1.00-5.00	
150612-HM												●												0.18-0.50	1.00-5.00		
Medium cutting 	DNMG 110404-MP							●	●				●			●	●								0.10-0.40	0.40-3.80	
	110408-MP							●	●				●				●	●							0.15-0.40	0.50-4.00	
	110412-MP																								0.15-0.50	0.80-4.20	
	110504-MP																								0.10-0.40	0.40-3.80	
	110508-MP																								0.15-0.40	0.50-4.00	
	110512-MP																								0.15-0.50	0.80-4.20	
	150404-MP							●	●				●			●	●	●		●					0.10-0.40	0.40-4.00	
	150408-MP							●	●				●			●	●	●	●	●					0.15-0.45	0.50-4.50	
	150412-MP							●	●				●							●					0.15-0.50	0.80-5.00	
	150416-MP																								0.15-0.50	0.85-5.00	
	150604-MP							●	●				●	●		●	●	●	●	●					0.10-0.40	0.40-4.00	
	150608-MP							●	●				●	●		●	●	●	●	●					0.15-0.45	0.50-4.50	
	150612-MP							●	●				●			●	●	●	●	●					0.15-0.50	0.80-5.00	
	150616-MP							●	●				●			●	●	●	●	●					0.15-0.55	0.85-5.00	

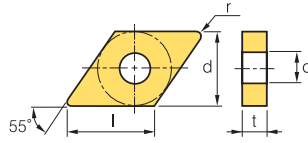
Cutting edge geometry A37~A49
 Recommended chip breaker B04~B15
 Code system B34~B35
 ● : Stock item

Available tool holders			
Designation	Page	Designation	Page
MCKNR/L	B183	MCRNR/L	B184
MCLNR/L	B183	PCBNR/L	B172
MCMNN	B183	PCLNR/L	B173



DN

Dimensions (mm)			
Size	d	t	d ₁
11	9.525	4.76	3.81
15	12.7	4.76~6.35	5.16



Rhombic 55° Negative

Workpiece	Steel	P															Machining types	
	Stainless steel	M															● Continuous cutting	
Cast iron	K															● General cutting		
Non-ferrous metal	N															● Interrupted cutting		
Heat resistant alloy, Titanium alloy	S																	
Hardened steel	H																	

Inserts	Designation	Cermet		Coated		Coated											Uncoated		Cutting Condition											
		CN1500	CN2500	CC1500	CC2500	NC3215	NC3225	NC3120	NC3030	NC3235	NC5330	NC6310	NC6315	NC9115	NC9125	NC9135	PC5300	PC5400	PC8105	PC8110	PC8115	PC9030	H01	H05	f _n (mm/rev)	a _p (mm)				
Medium cutting		DNMG 110404-VM																								0.05~0.30	0.90~4.00			
		110408-VM																									0.10~0.50	1.00~4.00		
		110412-VM																										0.13~0.50	1.30~4.00	
		150404-VM	●															●	●									0.05~0.30	0.90~5.00	
		150408-VM	●	●														●	●									0.10~0.50	1.00~5.00	
		150412-VM																●	●									0.13~0.60	1.30~5.00	
		150604-VM	●	●														●	●					●				0.05~0.30	0.90~5.00	
		150608-VM	●															●	●					●				0.10~0.50	1.00~5.00	
150612-VM																●	●									0.13~0.60	1.30~5.00			
Medium to roughing		DNMG 150404-B25		●																							0.17~0.45	1.00~4.00		
		150408-B25		●																								0.17~0.55	1.50~4.00	
		150412-B25																										0.25~0.55	1.50~4.00	
		150604-B25	●																									0.17~0.55	1.50~4.00	
		150608-B25	●																					●				0.17~0.55	1.50~4.00	
		150612-B25																											0.25~0.55	1.50~4.00
Roughing		DNMG 150408-GR																										0.20~0.50	1.00~7.00	
		150412-GR																										0.25~0.90	1.30~7.00	
		150416-GR																										0.30~0.75	1.80~7.00	
		150608-GR																										0.20~0.50	1.00~7.00	
		150612-GR																										0.25~0.70	1.30~7.00	
		150616-GR																										0.20~0.75	1.80~7.00	
Medium to finishing	 [Cermet]	DNMG 110404-VQ	●	●																							0.05~0.30	0.50~3.50		
		110408-VQ																										0.08~0.40	0.80~4.00	
		110412-VQ																										0.10~0.40	1.00~4.00	
		110508-VQ																										0.08~0.40	0.80~4.00	
		110512-VQ																										0.10~0.40	1.00~4.00	
		150404-VQ	●	●	●	●																						0.05~0.30	0.80~3.50	
		150408-VQ	●	●	●	●																						0.08~0.40	0.80~4.00	
		150412-VQ																										0.10~0.40	0.50~4.20	
		150604-VQ	●	●	●	●																							0.05~0.30	0.80~4.00
		150608-VQ	●	●	●	●																							0.08~0.40	0.80~4.00
150612-VQ																											0.10~0.40	0.50~4.20		

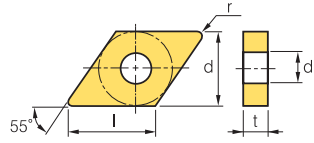
↻ Cutting edge geometry **A37~A49**
 ↻ Recommended chip breaker **B04~B15**
 ↻ Code system **B34~B35**
 ● : Stock item

Available tool holders			
Designation	Page	Designation	Page
MCKNR/L	B183	MCRNR/L	B184
MCLNR/L	B183	PCBNR/L	B172
MCMNN	B183	PCLNR/L	B173



B Turning Insert (Negative)

DN



Dimensions (mm)			
Size	d	t	d ₁
11	9.525	3.18~4.76	3.81
15	12.7	4.76~6.35	5.16
19	19.05	6.35	7.93

Rhombic 55° Negative

Workpiece	Material Compatibility													Machining types			
	Steel	Stainless steel	Cast iron	Non-ferrous metal	Heat resistant alloy, Titanium alloy	Hardened steel	P	M	K	N	S	H	●	⊕	⊖	⊙	
Steel							●	⊕	⊖	⊙	⊙	⊙	⊙	⊙	⊙	⊙	⊙
Stainless steel							●	⊕	⊖	⊙	⊙	⊙	⊙	⊙	⊙	⊙	⊙
Cast iron							●	⊕	⊖	⊙	⊙	⊙	⊙	⊙	⊙	⊙	⊙
Non-ferrous metal																	
Heat resistant alloy, Titanium alloy																	
Hardened steel																	

Inserts	Designation	Cermet		Coated		Coated										Uncoated		Cutting Condition								
		CN1500	CN2500	CC1500	CC2500	NC3215	NC3225	NC3120	NC3030	NC3235	NC5330	NC6310	NC6315	NC9115	NC9125	NC9135	PC5300	PC5400	PC8105	PC8110	PC8115	PC9030	H01	H05	f _n (mm/rev)	a _p (mm)
Medium cutting 	DNMG 150404-MK											●													0.05~0.30	0.90~5.00
	150408-MK											●													0.10~0.50	1.00~5.00
	150412-MK																								0.13~0.60	1.30~5.00
	150604-MK											●	●												0.05~0.30	0.90~5.00
	150608-MK											●	●												0.10~0.50	1.00~5.00
	150612-MK												●													0.13~0.60
Roughing 	DNMA 110408																								0.17~0.45	0.80~3.00
	150404																								0.17~0.55	0.40~4.00
	150408																								0.25~0.55	0.80~4.00
	150412											●													0.25~0.65	0.50~4.00
	150604																								0.17~0.55	0.40~4.00
	150608											●													0.25~0.55	0.80~4.00
	190608												●												0.25~0.65	1.20~4.00
Roughing 	DNMG 150408-RK																								0.15~0.50	1.50~5.00
	150412-RK											●													0.20~0.60	1.80~5.00
	150608-RK											●	●												0.15~0.50	1.50~5.00
	150612-RK												●												0.20~0.60	1.80~5.00
Roughing 	DNMG 150408-VR																								0.25~0.55	1.20~7.00
	150412-VR																								0.30~0.60	1.50~7.00
	150608-VR																								0.25~0.55	1.20~7.00
	150612-VR																								0.30~0.60	1.50~7.00
Medium cutting 	DNMG 110404-MM																								0.08~0.35	0.50~5.00
	110408-MM													●	●										0.10~0.40	0.50~5.00
	110412-MM																								0.12~0.45	0.50~5.00
	110504-MM																								0.08~0.35	0.50~5.00
	110508-MM																								0.10~0.40	0.50~5.00
	110512-MM																								0.12~0.45	0.50~5.00
	150404-MM														●	●	●								0.10~0.40	0.50~6.40
	150408-MM													●	●	●	●								0.12~0.45	0.50~6.40
	150412-MM													●	●	●									0.15~0.60	0.50~6.40
	150416-MM																								0.15~0.60	0.50~6.00
	150604-MM														●	●	●								0.10~0.40	0.50~6.40
	150608-MM													●	●	●	●								0.12~0.45	0.50~6.40
	150612-MM													●	●	●									0.15~0.60	0.50~6.40
150616-MM																								0.18~0.65	0.50~8.00	

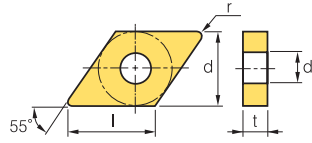
Cutting edge geometry A37~A49
 Recommended chip breaker B04~B15
 Code system B34~B35
 ● : Stock item

Available tool holders			
Designation	Page	Designation	Page
MCKNR/L	B183	MCRNR/L	B184
MCLNR/L	B183	PCBNR/L	B172
MCMNN	B183	PCLNR/L	B173



DN

Dimensions (mm)			
Size	d	t	d ₁
15	12.7	4.76~6.35	5.16



Rhombic 55° Negative

Workpiece	Machining types															
	P	M	K	N	S	H	●	●	●	●	●	●	●	●	●	●
Steel	●	●	●	●	●	●	●	●	●	●	●	●	●	●	●	●
Stainless steel	●	●	●	●	●	●	●	●	●	●	●	●	●	●	●	●
Cast iron	●	●	●	●	●	●	●	●	●	●	●	●	●	●	●	●
Non-ferrous metal	●	●	●	●	●	●	●	●	●	●	●	●	●	●	●	●
Heat resistant alloy, Titanium alloy	●	●	●	●	●	●	●	●	●	●	●	●	●	●	●	●
Hardened steel	●	●	●	●	●	●	●	●	●	●	●	●	●	●	●	●

Inserts	Designation	Cermets		Coated		Coated										Uncoated		Cutting Condition										
		CN1500	CN2500	CC1500	CC2500	NC3215	NC3225	NC3120	NC3030	NC3235	NC5330	NC6310	NC6315	NC9115	NC9125	NC9135	PC5300	PC5400	PC8105	PC8110	PC8115	PC9030	H01	H05	f _n (mm/rev)	a _p (mm)		
Roughing	 RM <small>new</small>	DNMG 150404-RM												●	●	●					●				0.10~0.50	2.00~6.00		
		150408-RM												●	●	●	●					●				0.15~0.55	2.00~6.00	
		150412-RM															●					●				0.20~0.60	2.00~6.00	
		150416-RM																				●				0.25~0.70	2.00~6.00	
		150604-RM													●	●	●					●	●			0.10~0.50	2.00~6.00	
		150608-RM												●	●	●					●	●				0.15~0.55	2.00~6.00	
		150612-RM												●	●	●										0.20~0.60	2.00~6.00	
		150616-RM																								0.25~0.70	2.00~6.00	
Finishing	 VP1	DNMG 150404-VP1																	●	●	●		●		0.05~0.15	0.10~1.50		
		150408-VP1																		●	●	●		●		0.07~0.20	0.10~1.50	
		150604-VP1																			●	●	●		●		0.05~0.15	0.10~1.50
		150608-VP1																			●	●	●		●		0.07~0.20	0.10~1.50
Finishing	 VP1	DNGG 150404-VP1																							0.05~0.15	0.10~1.50		
		150408-VP1																								0.07~0.20	0.10~1.50	
		150604-VP1																								0.05~0.15	0.10~1.50	
		150608-VP1																								0.07~0.20	0.10~1.50	
Medium to finishing	 VP2	DNMG 150404-VP2														●	●	●	●	●		●		0.05~0.30	0.10~3.00			
		150408-VP2														●	●	●	●	●		●		0.10~0.40	0.50~4.50			
		150604-VP2														●	●	●	●	●		●		0.05~0.30	0.10~3.00			
		150608-VP2								●						●	●	●	●	●		●		0.10~0.40	0.50~4.50			
Medium to finishing	 VP3	DNMG 150404-VP3														●	●		●	●		●	●	0.05~0.30	0.10~3.00			
		150408-VP3														●	●		●	●		●	●	0.10~0.45	0.50~5.00			
		150412-VP3														●	●	●	●	●		●		0.12~0.50	0.50~5.00			
		150604-VP3														●	●	●	●	●		●		0.05~0.30	0.10~3.00			
		150608-VP3														●	●	●	●	●		●		0.10~0.45	0.50~5.00			
		150612-VP3														●	●	●	●	●		●		0.12~0.50	0.50~5.00			
Medium cutting	 VP3	DNGG 150404-VP3																		●	●		●		0.05~0.30	0.10~3.00		
		150408-VP3																			●	●		●		0.10~0.45	0.50~5.00	
		150412-VP3																				●			●		0.12~0.50	0.50~5.00
		150604-VP3																				●	●		●		0.05~0.30	0.10~3.00
		150608-VP3																				●	●		●		0.10~0.45	0.50~5.00
		150612-VP3																				●	●		●		0.12~0.50	0.50~5.00

➡ Cutting edge geometry A37~A49
➡ Recommended chip breaker B04~B15
➡ Code system B34~B35
● : Stock item

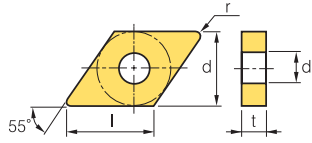
Available tool holders			
Designation	Page	Designation	Page
MCKNR/L	B183	MCRNR/L	B184
MCLNR/L	B183	PCBNR/L	B172
MCMNN	B183	PCLNR/L	B173



B Turning Insert (Negative)

DN

Dimensions (mm)			
Size	d	t	d ₁
15	12.7	4.76~6.35	5.16



Rhombic 55° Negative

Workpiece	Material Compatibility													Machining types				
	Steel	Stainless steel	Cast iron	Non-ferrous metal	Heat resistant alloy, Titanium alloy	Hardened steel	P	M	K	N	S	H	●	⊕	⊖	⊙	⊚	
Steel	●	●	●	●	●	●	●	●	●	●	●	●	●	●	●	●	●	●
Stainless steel	●	●	●	●	●	●	●	●	●	●	●	●	●	●	●	●	●	●
Cast iron	●	●	●	●	●	●	●	●	●	●	●	●	●	●	●	●	●	●
Non-ferrous metal	●	●	●	●	●	●	●	●	●	●	●	●	●	●	●	●	●	●
Heat resistant alloy, Titanium alloy	●	●	●	●	●	●	●	●	●	●	●	●	●	●	●	●	●	●
Hardened steel	●	●	●	●	●	●	●	●	●	●	●	●	●	●	●	●	●	●

Inserts	Designation	Cermet		Coated		Coated												Uncoated		Cutting Condition									
		CN1500	CN2500	CC1500	CC2500	NC3215	NC3225	NC3120	NC3030	NC3235	NC5330	NC6315	NC9115	NC9125	NC9135	PC5300	PC5400	PC8105	PC8110	PC8115	PC8120	PC9030	H01	H05	f _n (mm/rev)	a _p (mm)			
Roughing 	DNMG	150408-VP4																								0.15~0.35	1.00~4.00		
		150412-VP4																									0.20~0.40	1.00~4.00	
		150608-VP4																		●	●						0.15~0.35	1.00~4.00	
		150612-VP4																		●	●						0.20~0.40	1.00~4.00	
Medium to finishing 	DNMG	150404-HA																					●	●			0.05~0.30	0.80~3.50	
		150408-HA																					●	●			0.10~0.40	0.80~3.50	
		150604-HA																	●					●	●			0.05~0.30	0.80~3.50
		150608-HA																					●	●			0.10~0.40	0.80~3.50	
Finishing 	DNMG	150404-VW																									0.10~0.35	0.30~3.00	
		150408-VW																									0.10~0.40	0.30~3.00	
		150604-VW																									0.10~0.35	0.30~3.00	
		150608-VW																									0.10~0.40	0.30~3.00	
Medium cutting 	DNMG	150408-LW																									0.15~0.50	0.70~4.50	
		150412-LW																									0.20~0.60	1.00~5.00	
		150608-LW					●	●																			0.15~0.50	0.70~4.50	
		150612-LW					●	●																			0.20~0.60	1.00~5.00	
Medium to finishing 	DNMX	150404R-SR																									0.10~0.40	0.70~4.50	
		150408R-SR																									0.12~0.45	1.00~4.50	
		150604R-SR																									0.10~0.40	0.70~4.50	
		150608R-SR																									0.12~0.45	1.00~4.50	
		150404L-SR																										0.10~0.40	0.70~4.50
		150408L-SR																										0.12~0.45	1.00~4.50
		150604L-SR																										0.10~0.40	0.70~4.50
		150608L-SR																										0.12~0.45	1.00~4.50
Medium cutting 	DNMX	150404R-SH																									0.15~0.30	1.00~4.00	
		150408R-SH																									0.15~0.50	1.50~5.00	
		150604R-SH																									0.15~0.30	1.00~4.00	
		150608R-SH																									0.15~0.50	1.50~5.00	
		150404L-SH																										0.15~0.30	1.00~4.00
		150408L-SH																									0.15~0.50	1.50~5.00	
		150604L-SH																									0.15~0.30	1.00~4.00	
		150608L-SH																									0.15~0.50	1.50~5.00	

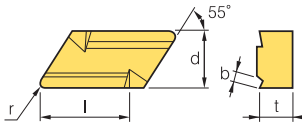
Cutting edge geometry A37~A49
 Recommended chip breaker B04~B15
 Code system B34~B35
 ● : Stock item

Available tool holders			
Designation	Page	Designation	Page
MCKNR/L	B183	MCRNR/L	B184
MCLNR/L	B183	PCBNR/L	B172
MCMNN	B183	PCLNR/L	B173



KN ○ ○

Dimensions (mm)		
Size	d	t
16	9.525	4.76



Parallelogram 55° Negative

Workpiece	Machining types															
	P	M	K	N	S	H										
Steel	●	●	●	●	●	●	●	●	●	●	●	●	●	●	●	●
Stainless steel	●	●	●	●	●	●	●	●	●	●	●	●	●	●	●	●
Cast iron	●	●	●	●	●	●	●	●	●	●	●	●	●	●	●	●
Non-ferrous metal	●	●	●	●	●	●	●	●	●	●	●	●	●	●	●	●
Heat resistant alloy, Titanium alloy	●	●	●	●	●	●	●	●	●	●	●	●	●	●	●	●
Hardened steel	●	●	●	●	●	●	●	●	●	●	●	●	●	●	●	●

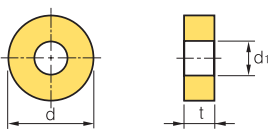
Inserts	Designation	Cermet		Coated		Coated										Uncoated		Cutting Condition										
		CN1500	CN2500	CC1500	CC2500	NC3215	NC3225	NC3120	NC3030	NC3235	NC5330	NC6310	NC6315	NC9115	NC9125	NC9135	PC5300	PC5400	PC8105	PC8110	PC8115	PC9030	H01	H05	fn (mm/rev)	ap (mm)		
Medium cutting	11	KNUX		160405R-11		●	●	●	●	●	●	●	●	●	●	●	●	●	●	●	●	●	●	●	●	0.20~0.35	1.00~6.00	
		160410R-11		●	●	●	●	●	●	●	●	●	●	●	●	●	●	●	●	●	●	●	●	●	●	0.30~0.60	1.50~6.00	
		160405L-11		●	●	●	●	●	●	●	●	●	●	●	●	●	●	●	●	●	●	●	●	●	●	●	0.20~0.35	1.00~6.00
		160410L-11		●	●	●	●	●	●	●	●	●	●	●	●	●	●	●	●	●	●	●	●	●	●	●	0.30~0.60	1.50~6.00
Roughing	12	KNUX		160405R-12		●	●	●	●	●	●	●	●	●	●	●	●	●	●	●	●	●	●	●	●	0.25~0.35	1.50~6.00	
		160410R-12		●	●	●	●	●	●	●	●	●	●	●	●	●	●	●	●	●	●	●	●	●	●	0.40~0.70	1.50~6.00	
		160405L-12		●	●	●	●	●	●	●	●	●	●	●	●	●	●	●	●	●	●	●	●	●	●	●	0.25~0.35	1.50~6.00
		160410L-12		●	●	●	●	●	●	●	●	●	●	●	●	●	●	●	●	●	●	●	●	●	●	●	0.40~0.70	1.50~6.00

➤ Cutting edge geometry A37~A49 ➤ Recommended chip breaker B04~B15 ➤ Code system B34~B35 ● : Stock item

Available tool holders			
Designation	Page	Designation	Page
CKJNR/L	B181	CKUNR/L	B212
CKNNR/L	B181		

RN ○ ○

Dimensions (mm)			
Size	d	t	d ₁
09	9.525	3.18	3.81
12	12.7	4.76	5.16
15	15.875	6.35	6.35
19	19.05	6.35	7.93
25	25.4	6.35~9.52	9.12
31	31.75	9.52	12.7



Round Negative

Workpiece	Machining types															
	P	M	K	N	S	H										
Steel	●	●	●	●	●	●	●	●	●	●	●	●	●	●	●	●
Stainless steel	●	●	●	●	●	●	●	●	●	●	●	●	●	●	●	●
Cast iron	●	●	●	●	●	●	●	●	●	●	●	●	●	●	●	●
Non-ferrous metal	●	●	●	●	●	●	●	●	●	●	●	●	●	●	●	●
Heat resistant alloy, Titanium alloy	●	●	●	●	●	●	●	●	●	●	●	●	●	●	●	●
Hardened steel	●	●	●	●	●	●	●	●	●	●	●	●	●	●	●	●

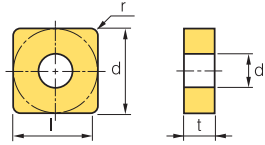
Inserts	Designation	Cermet		Coated		Coated										Uncoated		Cutting Condition										
		CN1500	CN2500	CC1500	CC2500	NC3215	NC3225	NC3120	NC3030	NC3235	NC5330	NC6310	NC6315	NC9115	NC9125	NC9135	PC5300	PC5400	PC8105	PC8110	PC8115	PC9030	H01	H05	fn (mm/rev)	ap (mm)		
General	B25	RNMG		090300-B25		●	●	●	●	●	●	●	●	●	●	●	●	●	●	●	●	●	●	●	●	0.90~4.50	0.09~0.90	
		120400-B25		●	●	●	●	●	●	●	●	●	●	●	●	●	●	●	●	●	●	●	●	●	●	1.20~4.80	0.12~1.20	
		150600-B25		●	●	●	●	●	●	●	●	●	●	●	●	●	●	●	●	●	●	●	●	●	●	●	1.15~1.50	1.50~7.50
		190600-B25		●	●	●	●	●	●	●	●	●	●	●	●	●	●	●	●	●	●	●	●	●	●	●	1.90~7.60	0.19~1.90
		250600-B25		●	●	●	●	●	●	●	●	●	●	●	●	●	●	●	●	●	●	●	●	●	●	●	2.50~10.0	0.25~2.50
		250900-B25		●	●	●	●	●	●	●	●	●	●	●	●	●	●	●	●	●	●	●	●	●	●	●	2.50~10.0	0.25~2.50
		310900-B25		●	●	●	●	●	●	●	●	●	●	●	●	●	●	●	●	●	●	●	●	●	●	●	3.50~13.0	0.30~2.50

➤ Cutting edge geometry A37~A49 ➤ Recommended chip breaker B04~B15 ➤ Code system B34~B35 ● : Stock item



B Turning Insert (Negative)

SN



Dimensions (mm)			
Size	d	t	d ₁
09	9.525	3.18	3.81
12	12.7	4.76	5.16

Square 90° Negative

Workpiece	Material											Machining types			
	Steel	Stainless steel	Cast iron	Non-ferrous metal	Heat resistant alloy, Titanium alloy	Hardened steel	P	M	K	N	S	H	●	⊙	⊕
Steel	●	●	●	●	●	●	●	●	●	●	●	●	●	●	●
Stainless steel	●	●	●	●	●	●	●	●	●	●	●	●	●	●	●
Cast iron	●	●	●	●	●	●	●	●	●	●	●	●	●	●	●
Non-ferrous metal	●	●	●	●	●	●	●	●	●	●	●	●	●	●	●
Heat resistant alloy, Titanium alloy	●	●	●	●	●	●	●	●	●	●	●	●	●	●	●
Hardened steel	●	●	●	●	●	●	●	●	●	●	●	●	●	●	●

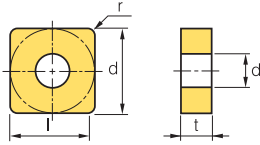
Inserts	Designation	Cermet		Coated		Coated										Uncoated		Cutting Condition											
		CN1500	CN2500	CC1500	CC2500	NC3215P	NC3225P	NC3215	NC3225	NC3120	NC3030	NC3235	NC5330	NC6310	NC6315	NC9115	NC9125	NC9135	PC8105	PC8110	PC8115	PC9030	H01	H05	f _n (mm/rev)	a _p (mm)			
Finishing		SNMG 120404-VB	●	●	●	●	●	●	●	●	●	●	●	●	●	●	●	●	●	●	●	●	●	●	0.15~0.35	0.30~2.00			
			120408-VB	●	●	●	●	●	●	●	●	●	●	●	●	●	●	●	●	●	●	●	●	●	●	●	0.15~0.40	0.50~2.00	
Finishing		SNMG 090304-VF	●	●	●	●	●	●	●	●	●	●	●	●	●	●	●	●	●	●	●	●	●	●	●	0.07~0.30	0.50~1.50		
			090308-VF	●	●	●	●	●	●	●	●	●	●	●	●	●	●	●	●	●	●	●	●	●	●	●	0.07~0.30	0.50~1.50	
			120404-VF	●	●	●	●	●	●	●	●	●	●	●	●	●	●	●	●	●	●	●	●	●	●	●	0.07~0.30	0.50~1.50	
			120408-VF	●	●	●	●	●	●	●	●	●	●	●	●	●	●	●	●	●	●	●	●	●	●	●	●	0.10~0.40	0.50~1.50
			120412-VF	●	●	●	●	●	●	●	●	●	●	●	●	●	●	●	●	●	●	●	●	●	●	●	●	0.20~0.50	0.50~1.50
Finishing		SNMG 120408-VL	●	●	●	●	●	●	●	●	●	●	●	●	●	●	●	●	●	●	●	●	●	●	●	0.10~0.35	0.20~1.50		
Medium to finishing		SNMG 090308-LP	●	●	●	●	●	●	●	●	●	●	●	●	●	●	●	●	●	●	●	●	●	●	●	0.10~0.30	0.30~1.50		
			090408-LP	●	●	●	●	●	●	●	●	●	●	●	●	●	●	●	●	●	●	●	●	●	●	●	0.10~0.30	0.30~1.50	
			120404-LP	●	●	●	●	●	●	●	●	●	●	●	●	●	●	●	●	●	●	●	●	●	●	●	0.10~0.35	0.30~2.00	
			120408-LP	●	●	●	●	●	●	●	●	●	●	●	●	●	●	●	●	●	●	●	●	●	●	●	●	0.10~0.40	0.50~2.50
			120412-LP	●	●	●	●	●	●	●	●	●	●	●	●	●	●	●	●	●	●	●	●	●	●	●	●	0.13~0.45	0.80~3.00
Medium to finishing		SNMG 090304-CP	●	●	●	●	●	●	●	●	●	●	●	●	●	●	●	●	●	●	●	●	●	●	●	0.08~0.30	0.40~3.00		
			090308-CP	●	●	●	●	●	●	●	●	●	●	●	●	●	●	●	●	●	●	●	●	●	●	●	0.10~0.30	0.40~3.00	
			090404-CP	●	●	●	●	●	●	●	●	●	●	●	●	●	●	●	●	●	●	●	●	●	●	●	0.08~0.30	0.40~3.00	
			090408-CP	●	●	●	●	●	●	●	●	●	●	●	●	●	●	●	●	●	●	●	●	●	●	●	0.10~0.30	0.40~3.00	
			120404-CP	●	●	●	●	●	●	●	●	●	●	●	●	●	●	●	●	●	●	●	●	●	●	●	0.10~0.35	0.50~3.50	
			120408-CP	●	●	●	●	●	●	●	●	●	●	●	●	●	●	●	●	●	●	●	●	●	●	●	●	0.12~0.35	0.50~3.50
120412-CP	●	●	●	●	●	●	●	●	●	●	●	●	●	●	●	●	●	●	●	●	●	●	●	●	0.13~0.35	0.80~3.50			
Medium to finishing		SNMG 120408-VC	●	●	●	●	●	●	●	●	●	●	●	●	●	●	●	●	●	●	●	●	●	●	●	0.15~0.40	0.50~3.50		

Cutting edge geometry A37~A49
 Recommended chip breaker B04~B15
 Code system B34~B35
 ● : Stock item

Available tool holders					
Designation	Page	Designation	Page	Designation	Page
MSBNR/L	B185	MSRNR/L	B186	PSDNN	B175
MSDNN	B185	MSSNR/L	B187	PSKNR/L	B176
MSKNR/L	B186	PSBNR/L	B175	PSSNR/L	B177



SN



Dimensions (mm)			
Size	d	t	d ₁
09	9.525	3.18	3.81
12	12.7	3.18~4.76	5.16
15	15.875	4.76~6.35	6.35
19	19.05	4.76~6.35	7.93

Square **90° Negative**

Workpiece	Material	Grade	Machining types																		
			●	*	●	*	●	*	●	*	●	*	●	*	●	*	●	*	●	*	
Steel		P	●	*	●	*	●	*	●	*	●	*	●	*	●	*	●	*	●	*	
Stainless steel		M																			
Cast iron		K	●	*	●	*	●	*	●	*	●	*	●	*	●	*	●	*	●	*	
Non-ferrous metal		N																			
Heat resistant alloy, Titanium alloy		S																			
Hardened steel		H																			

Inserts	Designation	Cermet		Coated		Coated												Uncoated		Cutting Condition							
		CN1500	CN2500	CC1500	CC2500	NC3215	NC3225	NC3120	NC3030	NC3235	NC5330	NC6310	NC6315	NC9115	NC9125	NC9135	PC5300	PC5400	PC8105	PC8110	PC8115	PC9030	H01	H05	f _n (mm/rev)	a _p (mm)	
HM 	SNMG 120404-HM																						●			0.15~0.42	0.60~4.20
	120408-HM					●		●	●				●										●			0.10~0.50	1.00~5.00
	120412-HM					●																	●			0.18~0.50	1.00~5.00
MP 	SNMG 090304-MP					●	●				●															0.10~0.40	0.40~3.80
	090308-MP					●	●				●															0.15~0.40	0.50~4.00
	090312-MP																									0.15~0.50	0.80~4.20
	090404-MP																									0.10~0.40	0.40~3.80
	090408-MP																									0.15~0.40	0.50~4.00
	090412-MP																									0.15~0.50	0.80~4.20
	120404-MP					●	●				●			●	●	●			●	●						0.10~0.40	0.40~4.00
	120408-MP					●	●				●			●	●	●			●	●						0.15~0.45	0.50~4.50
	120412-MP					●	●				●			●	●	●			●	●						0.15~0.50	0.80~5.00
	120416-MP					●	●				●															0.18~0.60	0.80~7.00
	150608-MP																									0.15~0.50	0.50~7.00
	150612-MP																									0.18~0.60	0.80~8.50
190608-MP																									0.15~0.50	0.50~8.50	
190612-MP																									0.18~0.60	0.80~8.50	
VM 	SNMG 090304-VM																								0.05~0.30	0.90~3.50	
	090308-VM																								0.10~0.50	1.00~3.50	
	120404-VM	●								●					●	●									0.05~0.30	0.90~5.00	
	120408-VM	●							●	●			●		●	●			●		●				0.10~0.50	1.00~5.00	
	120412-VM									●					●	●									0.13~0.60	1.30~5.00	
	190612-VM																								0.25~0.60	2.50~7.50	
190616-VM																								0.25~0.60	2.50~7.50		

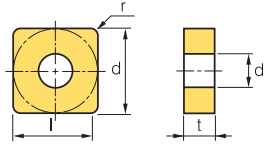
Cutting edge geometry **A37~A49**
 Recommended chip breaker **B04~B15**
 Code system **B34~B35**
 ● : Stock item

Available tool holders					
Designation	Page	Designation	Page	Designation	Page
MSBNR/L	B185	MSRNR/L	B186	PSDNN	B175
MSDNN	B185	MSSNR/L	B187	PSKNR/L	B176
MSKNR/L	B186	PSBNR/L	B175	PSSNR/L	B177



B Turning Insert (Negative)

SN



Dimensions (mm)			
Size	d	t	d ₁
09	9.525	3.18	3.81
12	12.7	3.18~4.76	5.16
15	15.875	4.76~6.35	6.35
19	19.05	6.35	7.93
25	25.4	7.94~9.52	9.12

□ Square 90° Negative

Workpiece	Material	Machining types																
		● Continuous cutting ◐ General cutting ✱ Interrupted cutting																
Steel	P	●	✱	●	◐	●	◐	◐	✱	✱	✱	●	●	●	●	✱		
Stainless steel	M	●	✱	●	◐				✱	✱	✱	●	●	●	●	●	●	✱
Cast iron	K	●	✱	●	◐				✱	✱	✱	●	●	●	●	●	●	✱
Non-ferrous metal	N																	
Heat resistant alloy, Titanium alloy	S																	
Hardened steel	H																	

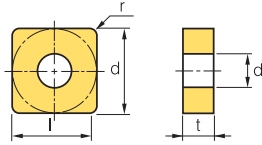
Inserts	Designation	Cermet		Coated		Coated										Uncoated		Cutting Condition									
		CN1500	CN2500	CC1500	CC2500	NC3215	NC3225	NC3120	NC3030	NC3235	NC5330	NC6310	NC6315	NC9115	NC9125	NC9135	PC5300	PC5400	PC8105	PC8110	PC8115	PC9030	H01	H05	f _n (mm/rev)	a _p (mm)	
Medium to roughing B25 	SNMG 090308-B25																								0.17~0.45	0.80~3.50	
	120404-B25	●	●			●	●		●	●																0.17~0.45	1.00~3.50
	120408-B25	●	●			●	●		●	●						●	●						●			0.23~0.60	1.50~5.00
	120412-B25		●			●	●		●	●																0.25~0.60	2.00~5.00
	120416-B25					●	●		●	●																0.35~0.70	2.50~5.00
	120420-B25																									0.40~0.70	3.00~5.00
	150608-B25									●																0.25~0.60	1.50~6.00
	150612-B25																									0.25~0.60	2.00~6.00
	150616-B25									●																0.35~0.70	2.00~6.00
	190608-B25								●	●		●														0.25~0.60	3.00~8.00
	190612-B25								●	●		●		●												0.30~0.60	3.00~8.00
	190616-B25								●	●		●		●												0.35~0.70	3.00~8.00
	250716-B25																									0.35~0.70	4.00~12.00
	250724-B25								●				●													0.50~1.00	5.00~12.00
250924-B25								●																	0.50~1.00	5.00~12.00	
Roughing GR 	SNMG 120404-GR																								0.15~0.45	0.08~6.00	
	120408-GR										●		●	●	●											0.20~0.50	1.00~7.00
	120412-GR										●			●												0.20~0.50	1.00~7.00
	150608-GR										●															0.25~0.60	1.00~7.00
	150612-GR								●	●	●	●														0.29~0.75	1.40~7.00
	190608-GR										●															0.30~0.80	1.70~9.00
	190612-GR								●	●	●	●		●												0.30~0.80	1.70~9.00
	190616-GR								●	●	●	●		●												0.31~0.82	1.90~12.30
	190624-GR																									0.35~0.82	2.00~12.50
	250724-GR											●														0.45~1.20	2.60~14.00
250924-GR										●	●														0.50~1.20	2.60~14.00	
Medium to finishing VQ [Cermet]	SNMG 090304-VQ																								0.05~0.30	0.50~3.50	
	090408-VQ																									0.08~0.30	0.80~4.00
	090412-VQ																									0.10~0.30	1.00~4.00
	120404-VQ	●	●																							0.05~0.30	0.80~4.00
	120408-VQ	●	●																							0.08~0.40	0.80~4.00

➤ Cutting edge geometry A37~A49
➤ Recommended chip breaker B04~B15
➤ Code system B34~B35
● : Stock item

Available tool holders					
Designation	Page	Designation	Page	Designation	Page
MSBNR/L	B185	MSRNR/L	B186	PSDNN	B175
MSDNN	B185	MSSNR/L	B187	PSKNR/L	B176
MSKNR/L	B186	PSBNR/L	B175	PSSNR/L	B177



SN



Dimensions (mm)			
Size	d	t	d ₁
09	9.525	3.18	3.81
12	12.7	3.18~4.76	5.16
15	15.875	4.76~6.35	6.35
19	19.05	4.76~6.35	7.93
25	25.4	6.35~9.52	9.12

○ Square **90° Negative**

Workpiece	Material	Grade	Cutting Conditions																Machining types											
			●	✱	●	✱	●	✱	●	✱	●	✱	●	✱	●	✱	●	✱												
Steel	Stainless steel	P	●	✱	●	✱	●	✱	●	✱	●	✱	●	✱	●	✱	●	✱	●	✱	●	✱	●	✱	●	✱	●	✱	●	✱
Cast iron	Non-ferrous metal	M	●	✱	●	✱	●	✱	●	✱	●	✱	●	✱	●	✱	●	✱	●	✱	●	✱	●	✱	●	✱	●	✱	●	✱
Heat resistant alloy, Titanium alloy	Hardened steel	K	●	✱	●	✱	●	✱	●	✱	●	✱	●	✱	●	✱	●	✱	●	✱	●	✱	●	✱	●	✱	●	✱	●	✱
		N	●	✱	●	✱	●	✱	●	✱	●	✱	●	✱	●	✱	●	✱	●	✱	●	✱	●	✱	●	✱	●	✱	●	✱
		S	●	✱	●	✱	●	✱	●	✱	●	✱	●	✱	●	✱	●	✱	●	✱	●	✱	●	✱	●	✱	●	✱	●	✱
		H	●	✱	●	✱	●	✱	●	✱	●	✱	●	✱	●	✱	●	✱	●	✱	●	✱	●	✱	●	✱	●	✱	●	✱

Inserts	Designation	Cermet		Coated		Coated													Uncoated		Cutting Condition						
		CN1500	CN2500	CC1500	CC2500	NC3215	NC3225	NC3120	NC3030	NC3235	NC5330	NC6310	NC6315	NC9115	NC9125	NC9135	PC5300	PC5400	PC8105	PC8110	PC8115	PC9030	H01	H05	f _n (mm/rev)	a _p (mm)	
Medium cutting	SNGG	090304R																								0.12~0.35	1.00~3.00
		090308R																								0.15~0.35	1.00~3.00
		120404R																								0.15~0.35	1.00~4.00
		120408R																								0.15~0.35	1.00~4.00
		120412R																								0.15~0.35	1.00~4.00
		090304L																								0.12~0.35	1.00~3.00
		090308L																								0.15~0.35	1.00~3.00
		120404L																								0.15~0.35	1.00~4.00
		120408L																								0.15~0.35	1.00~4.00
		120412L																								0.15~0.35	1.00~4.00
Medium cutting	SNMG	090308-MK																								0.17~0.45	0.80~3.50
		120404-MK																								0.08~0.45	0.80~4.00
		120408-MK											●													0.10~0.50	1.00~5.00
		120412-MK											●													0.13~0.60	1.30~5.00
		120416-MK																								0.15~0.63	1.50~6.00
		150608-MK																								0.25~0.60	1.80~6.00
		150612-MK																								0.20~0.70	1.80~7.00
		150616-MK																								0.23~0.70	2.00~7.50
		190608-MK																								0.31~0.75	2.30~9.50
		190612-MK												●												0.33~0.78	2.50~10.00
	190616-MK																								0.35~0.78	2.70~10.00	
Roughing	SNMA	090304																								0.10~0.45	0.50~4.50
		090308																								0.15~0.50	0.50~4.50
		090312																								0.20~0.50	0.50~4.50
		120402																								0.10~0.50	1.00~4.50
		120404																								0.15~0.60	1.00~5.00
		120408												●												0.15~0.70	1.00~6.00
		120412												●												0.20~0.80	1.50~6.00
		120416												●												0.30~1.00	2.00~6.00
		120420																								0.30~0.70	2.50~5.00
		150612																								0.20~0.80	2.00~8.00
		150616												●												0.25~0.85	2.50~10.00
		190608																								0.20~0.80	2.00~10.00
		190612												●												0.20~0.80	2.00~10.00
		190616											●	●												0.25~0.85	2.50~10.00
		190624																								0.35~0.90	3.00~10.00
		250724																								0.40~1.00	3.00~13.00
		250924																								0.40~1.00	3.00~13.00

↻ Cutting edge geometry **A37~A49**
 ↻ Recommended chip breaker **B04~B15**
 ↻ Code system **B34~B35**
 ● : Stock item

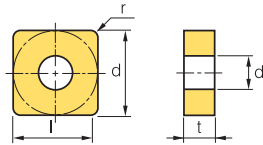
Available tool holders					
Designation	Page	Designation	Page	Designation	Page
MSBNR/L	B185	MSRNR/L	B186	PSDNN	B175
MSDNN	B185	MSSNR/L	B187	PSKNR/L	B176
MSKNR/L	B186	PSBNR/L	B175	PSSNR/L	B177



B Turning Insert (Negative)

SN

□ Square 90° Negative



Dimensions (mm)			
Size	d	t	d ₁
09	9.525	3.18	3.81
12	12.7	4.76	5.16
15	15.875	6.35	6.35
19	19.05	6.35	7.93
25	25.4	7.94	9.12

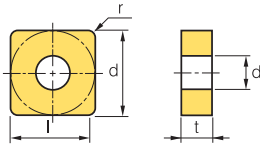
Workpiece	Material	Code	Machining types																	
			●	✱	●	✱	●	✱	●	✱	●	✱	●	✱	●	✱				
Steel	P																			
Stainless steel	M																			
Cast iron	K																			
Non-ferrous metal	N																			
Heat resistant alloy, Titanium alloy	S																			
Hardened steel	H																			

Inserts	Designation	Cermet		Coated		Coated										Uncoated		Cutting Condition											
		CN1500	CN2500	CC1500	CC2500	NC3215	NC3225	NC3120	NC3030	NC3235	NC5330	NC6310	NC6315	NC9115	NC9125	NC9135	PC5300	PC5400	PC8105	PC8110	PC8115	PC9030	H01	H05	f _n (mm/rev)	a _p (mm)			
Roughing		SNGA 090304																								0.17~0.50	0.50~4.50		
		090308																									0.17~0.50	0.50~4.50	
		120404																									0.15~0.60	1.50~8.00	
		120408																									0.15~0.60	1.50~8.00	
		120412																									0.20~0.80	1.50~8.00	
		150608																									0.20~0.80	2.00~10.00	
		150616																									0.20~0.90	2.00~10.00	
		190608																										0.15~0.60	3.00~12.00
		190612																										0.20~0.80	3.00~12.00
Roughing		SNMG 120404-RK																									0.15~0.50	1.20~6.00	
		120408-RK										●	●														0.23~0.53	1.50~6.00	
		120412-RK										●	●														0.28~0.53	1.80~6.00	
		120416-RK											●														0.28~0.53	2.00~6.00	
		150612-RK																										0.20~0.70	1.80~7.00
		150616-RK																										0.23~0.70	2.00~7.50
		190612-RK																										0.33~0.78	2.50~10.00
		190616-RK																										0.35~0.78	2.70~10.00
Roughing		SNMG 120408-VR																									0.25~0.55	1.20~7.00	
		120412-VR																									0.30~0.60	1.50~7.00	
		120416-VR																									0.35~0.60	2.00~7.00	
		190612-VR						●	●																		0.35~0.70	2.00~10.00	
		190616-VR						●	●																			0.35~0.75	2.20~10.00
Medium cutting		SNMG 090304-MM																									0.08~0.35	0.50~5.00	
		090308-MM																									0.10~0.40	0.50~5.00	
		090312-MM																									0.12~0.45	0.50~5.00	
		090404-MM																									0.08~0.35	0.50~5.00	
		090408-MM																									0.10~0.40	0.50~5.00	
		120404-MM												●	●	●	●				●	●					0.10~0.40	0.50~6.40	
		120408-MM												●	●	●	●			●	●	●					0.12~0.45	0.50~6.40	
		120412-MM													●	●	●						●	●				0.15~0.60	0.50~6.40
		120416-MM														●	●	●										0.18~0.65	0.50~6.40
		150608-MM																										0.12~0.45	0.50~8.00
		150612-MM														●	●	●						●	●			0.15~0.60	0.50~8.00
		150616-MM														●	●											0.18~0.65	0.50~8.00
		190608-MM														●	●	●						●				0.12~0.45	0.50~9.50
		190612-MM														●	●	●						●	●			0.15~0.60	0.50~9.50
		190616-MM														●	●									●		0.18~0.65	0.50~9.50
		250924-MM															●											0.20~0.80	1.00~10.00

🔄 Cutting edge geometry **A37~A49**
🔄 Recommended chip breaker **B04~B15**
🔄 Code system **B34~B35**
● : Stock item

Available tool holders					
Designation	Page	Designation	Page	Designation	Page
MSBNR/L	B185	MSRNR/L	B186	PSDNN	B175
MSDNN	B185	MSSNR/L	B187	PSKNR/L	B176
MSKNR/L	B186	PSBNR/L	B175	PSSNR/L	B177





Dimensions (mm)			
Size	d	t	d ₁
12	12.7	4.76	5.16
15	15.875	6.35	6.35
16	9.525	3.18~4.76	3.81
19	19.05	6.35	7.93
25	25.4	7.94	9.12

Square **90° Negative**

Workpiece	Material	Grade	Machining types															
			●	●	●	●	●	●	●	●	●	●	●	●	●	●	●	●
Steel		P	●	●	●	●	●	●	●	●	●	●	●	●	●	●	●	●
Stainless steel		M	●	●	●	●	●	●	●	●	●	●	●	●	●	●	●	●
Cast iron		K	●	●	●	●	●	●	●	●	●	●	●	●	●	●	●	●
Non-ferrous metal		N	●	●	●	●	●	●	●	●	●	●	●	●	●	●	●	●
Heat resistant alloy, Titanium alloy		S	●	●	●	●	●	●	●	●	●	●	●	●	●	●	●	●
Hardened steel		H	●	●	●	●	●	●	●	●	●	●	●	●	●	●	●	●

Inserts	Designation	Cermet		Coated		Coated										Uncoated		Cutting Condition									
		CN1500	CN2500	CC1500	CC2500	NC3215	NC3225	NC3120	NC3030	NC3235	NC5330	NC6315	NC9115	NC9125	NC9135	PC5300	PC5400	PC8105	PC8110	PC8115	PC8120	PC9030	H01	H05	f _n (mm/rev)	a _p (mm)	
RM 	SNMG 120404-RM											●	●	●	●					●					0.10~0.50	2.00~6.00	
	120408-RM											●	●	●	●					●	●	●				0.15~0.55	2.00~6.00
	120412-RM												●	●	●						●					0.20~0.60	2.00~6.00
	120416-RM																					●				0.25~0.70	2.00~6.00
	150608-RM																									0.20~0.60	0.20~6.00
	150612-RM												●	●	●							●				0.20~0.60	2.00~8.00
	150616-RM																									0.25~0.70	2.00~8.00
	190608-RM													●	●	●						●				0.20~0.60	2.00~10.00
	190612-RM													●	●	●						●				0.20~0.60	2.00~10.00
	190616-RM													●	●											0.27~0.70	2.00~10.00
190624-RM																									0.30~0.75	3.00~10.00	
250924-RM																									0.40~1.20	4.00~14.00	
VP2 	SNMG 120404-VP2															●	●	●	●	●			●		0.05~0.35	0.10~3.00	
	120408-VP2							●								●	●	●	●	●			●		0.10~0.45	0.50~4.50	
	120412-VP2															●	●	●	●	●			●		0.10~0.50	0.50~5.00	
VP3 	SNMG 120404-VP3															●	●	●	●	●			●	●	0.05~0.30	0.10~3.00	
	120408-VP3															●	●	●	●	●			●	●	0.10~0.45	1.00~5.00	
	120412-VP3															●	●	●	●	●			●		0.12~0.50	1.00~5.00	
	120416-VP3																									0.25~0.45	0.50~4.00
	160608-VP3																									0.15~0.35	0.80~6.00
	160612-VP3																									0.20~0.40	1.00~6.00
	160616-VP3																									0.20~0.40	1.00~6.00
	190608-VP3																									0.15~0.35	0.80~7.00
190612-VP3																									0.20~0.40	1.00~7.00	
190616-VP3																									0.25~0.45	1.00~7.00	
VP3 	SNGG 120404-VP3																						●		0.05~0.30	0.10~3.00	
	120408-VP3																						●		0.10~0.45	1.00~5.00	
	120412-VP3																						●		0.12~0.50	1.00~5.00	
VP4 	SNMG 120408-VP4																								0.15~0.35	1.00~4.00	
	120412-VP4																								0.20~0.40	1.00~4.00	
	150612-VP4																								0.20~0.45	1.00~5.00	
	190608-VP4																								0.20~0.50	1.00~9.00	
	190612-VP4																								0.23~0.55	1.00~9.00	
190616-VP4																								0.27~0.60	1.00~9.00		

Cutting edge geometry **A37~A49**
 Recommended chip breaker **B04~B15**
 Code system **B34~B35**
● : Stock item

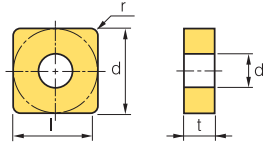
Available tool holders					
Designation	Page	Designation	Page	Designation	Page
MSBNR/L	B185	MSRNR/L	B186	PSDNN	B175
MSDNN	B185	MSSNR/L	B187	PSKNR/L	B176
MSKNR/L	B186	PSBNR/L	B175	PSSNR/L	B177



B Turning Insert (Negative)

SN ○ ○

○ Square **90° Negative**



Dimensions (mm)			
Size	d	t	d ₁
09	9.525	3.18	3.81
12	12.7	4.76	5.16
15	15.875	6.35	6.35
19	19.05	6.35	7.93
25	25.4	7.94~9.52	9.12

Workpiece	Material																Machining types			
	Steel	Stainless steel	Cast iron	Non-ferrous metal	Heat resistant alloy, Titanium alloy	Hardened steel	P	M	K	N	S	H	●	⊕	⊖	⊙	⊚	⊛	⊜	
Steel							●	⊕	⊖	⊙	⊚	⊛	⊜							
Stainless steel																				
Cast iron																				
Non-ferrous metal																				
Heat resistant alloy, Titanium alloy																				
Hardened steel																				

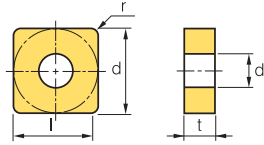
Inserts	Designation	Cermet		Coated		Coated												Uncoated		Cutting Condition									
		CN1500	CN2500	CC1500	CC2500	NC3215	NC3225	NC3120	NC3030	NC3235	NC5330	NC6310	NC6315	NC9115	NC9125	NC9135	PC5300	PC5400	PC8105	PC8110	PC8115	PC9030	H01	H05	f _n (mm/rev)	a _p (mm)			
Medium to finishing	HA																									●	●	0.10-0.35	0.80-3.50
																										●	●	0.10-0.40	0.80-3.50
																										●	●	0.13-0.55	0.80-3.50
Roughing	SNGN																											0.05-0.30	0.50-4.00
																												0.10-0.35	0.50-4.00
																												0.10-0.40	1.00-4.00
																												0.13-0.50	1.30-5.00
																												0.15-0.60	1.50-6.00
																												0.17-0.60	1.70-6.00
																												0.10-0.45	1.00-5.00
																												0.13-0.50	1.30-5.00
																												0.15-0.60	1.50-6.00
																												0.17-0.60	1.70-6.00
																												0.20-0.65	2.00-6.00
																												0.10-0.50	0.50-6.00
																												0.15-0.60	1.50-8.00
																												0.17-0.60	2.00-8.00
																												0.20-0.65	2.50-8.50
																												0.10-0.60	2.00-8.50
																												0.17-0.70	2.50-10.00
																										0.20-0.75	2.50-10.00		
																										0.30-0.80	3.00-12.00		
																										0.35-1.00	4.00-12.00		
Medium to roughing	SNUN																											0.23-0.60	1.50-5.00
																												0.25-0.60	2.00-5.00
																												0.30-1.00	3.00-10.00
																												0.25-0.60	2.00-5.00
																												0.30-1.20	3.00-12.00
Medium cutting	SNMX																											0.15-0.35	1.00-4.00

➤ Cutting edge geometry A37~A49 ➤ Recommended chip breaker B04~B15 ➤ Code system B34~B35 ● : Stock item

Available tool holders					
Designation	Page	Designation	Page	Designation	Page
MSBNR/L	B185	MSRNR/L	B186	PSDNN	B175
MSDNN	B185	MSSNR/L	B187	PSKNR/L	B176
MSKNR/L	B186	PSBNR/L	B175	PSSNR/L	B177






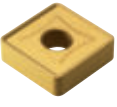
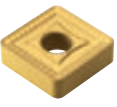
SN



Dimensions (mm)			
Size	d	t	d ₁
12	12.7	4.76	5.16
15	15.875	6.35	6.35
19	19.05	6.35	7.93
25	25.4	7.94~9.52	9.12

 Square **90° Negative**

Workpiece	Material	Machining types																					
		● Continuous cutting				● General cutting				● Interrupted cutting													
Steel	P	●	●	●	●	●	●	●	●	●	●	●	●	●	●	●	●	●	●	●	●	●	●
Stainless steel	M	●	●	●	●	●	●	●	●	●	●	●	●	●	●	●	●	●	●	●	●	●	●
Cast iron	K	●	●	●	●	●	●	●	●	●	●	●	●	●	●	●	●	●	●	●	●	●	●
Non-ferrous metal	N	●	●	●	●	●	●	●	●	●	●	●	●	●	●	●	●	●	●	●	●	●	●
Heat resistant alloy, Titanium alloy	S	●	●	●	●	●	●	●	●	●	●	●	●	●	●	●	●	●	●	●	●	●	●
Hardened steel	H	●	●	●	●	●	●	●	●	●	●	●	●	●	●	●	●	●	●	●	●	●	●

Inserts	Designation	Cermet		Coated		Coated													Uncoated		Cutting Condition								
		CN1500	CN2500	CC1500	CC2500	NC3215	NC3225	NC3120	NC3030	NC3235	NC5330	NC6310	NC6315	NC9115	NC9125	NC9135	PC5300	PC5400	PC8105	PC8110	PC8115	PC9030	H01	H05	f _n (mm/rev)	a _p (mm)			
Medium cutting		SNGX 120408R																								0.15~0.35	1.00~4.00		
		Roughing		SNMM 120408-GR																								0.20~0.50	1.00~7.00
120412-GR										●																	0.25~0.65	1.30~7.00	
190612-GR																												0.25~0.65	1.30~11.50
190616-GR																												0.32~0.85	1.80~11.50
Heavy		SNMM 120408-GH																									0.30~0.60	2.50~8.00	
		120412-GH								●																		0.30~0.70	2.50~8.00
		150612-GH																										0.30~0.70	2.50~8.00
		190612-GH								●																		0.30~0.70	3.00~8.00
		190616-GH								●																		0.45~1.00	4.00~9.00
		190624-GH								●																		0.55~1.20	4.00~9.00
		250724-GH								●																		0.55~1.20	5.00~12.00
		250924-GH								●																		0.55~1.20	5.00~12.00
Heavy		SNMM 190612-VH																									0.50~0.90	5.00~10.00	
		190616-VH																										0.50~1.10	5.00~10.00
		190624-VH																										0.60~1.20	6.00~12.00
		250716-VH																										0.70~1.50	6.00~14.00
		250724-VH																										0.70~1.40	6.00~15.00
		250920-VH																										0.70~1.40	6.00~15.00
		250924-VH																										0.70~1.40	6.00~15.00
		Heavy		SNMM 190612-VT																									0.60~1.00
190616-VT																												0.60~1.10	6.00~13.00
190624-VT																												0.60~1.60	7.00~13.00
250716-VT																												0.75~1.60	7.00~15.00
250724-VT																												0.75~1.60	7.00~15.00
250920-VT																												0.75~1.60	7.00~15.00
250924-VT																												0.75~1.60	7.00~17.00

➤ Cutting edge geometry **A37~A49**
➤ Recommended chip breaker **B04~B15**
➤ Code system **B34~B35**
● : Stock item

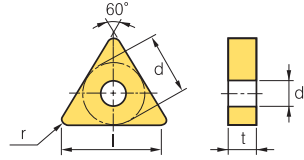
Available tool holders					
Designation	Page	Designation	Page	Designation	Page
MSBNR/L	B185	MSRNR/L	B186	PSDNN	B175
MSDNN	B185	MSSNR/L	B187	PSKNR/L	B176
MSKNR/L	B186	PSBNR/L	B175	PSSNR/L	B177



B Turning Insert (Negative)

TN

Triangular 60° Negative



Dimensions (mm)			
Size	d	t	d ₁
11	6.35	3.18	2.40
16	9.525	3.18~4.76	3.81
22	12.7	4.76	5.16

Workpiece	Material	Compatibility																Machining types
		P	M	K	N	S	H											
Steel	P	●	✳	●	✳	●	✳	●	✳	●	✳	●	✳	●	✳	●	✳	● Continuous cutting ✳ General cutting ✳ Interrupted cutting
Stainless steel	M																	
Cast iron	K	●	✳	●	✳	●	✳	●	✳	●	✳	●	✳	●	✳	●	✳	
Non-ferrous metal	N																	
Heat resistant alloy, Titanium alloy	S																	
Hardened steel	H																	

Inserts	Designation	Cermets		Coated		Coated														Uncoated		Cutting Condition							
		CN1500	CN2500	CC1500	CC2500	NC3215P	NC3225P	NC3215	NC3225	NC3120	NC3030	NC3235	NC5330	NC6310	NC6315	NC9115	NC9125	NC9135	PC8105	PC8110	PC8115	PC9030	H01	H05	f _n (mm/rev)	a _p (mm)			
Finishing	VB	TNMG		160404-VB		●	●	●	●		●	●	●	●	●	●	●	●	●	●	●	●	●			0.10~0.35	0.30~1.50		
		160408-VB		●	●	●	●		●	●		●														0.15~0.45	0.50~7.00		
		160412-VB							●	●																	0.18~0.45	0.80~3.00	
		220408-VB								●				●													0.15~0.45	0.50~2.50	
		220412-VB																										0.20~0.50	0.70~2.50
Finishing	VL	TNMG		160404-VL		●					●															0.05~0.25	0.10~1.00		
		160408-VL		●					●	●			●														0.10~0.35	0.20~1.50	
		160412-VL							●																		0.15~0.40	0.20~1.50	
		220408-VL																									0.10~0.35	0.20~1.50	
		220412-VL																										0.10~0.35	0.50~2.00
Finishing	VF	TNMG		110304-VF		●									●											0.05~0.20	0.20~1.00		
		160404-VF		●							●				●						●						0.07~0.30	0.50~1.50	
		160408-VF								●	●				●													0.10~0.40	0.50~1.50
		160412-VF																										0.15~0.50	0.50~1.50
		220404-VF																						●				0.10~0.40	0.50~1.50
		220408-VF																										0.10~0.40	0.50~1.50
Medium to finishing	LP <small>new</small>	TNMG		110304-LP																						0.07~0.30	0.30~1.50		
		110308-LP																									0.10~0.30	0.30~1.50	
		160404-LP								●	●				●													0.10~0.35	0.30~2.00
		160408-LP								●	●				●													0.10~0.40	0.50~2.50
		160412-LP								●	●																	0.13~0.45	0.80~3.00
Medium to finishing	CP <small>new</small>	TNMG		110304-CP																							0.08~0.26	0.40~2.50	
		110308-CP																									0.10~0.26	0.40~2.50	
		160404-CP							●	●																		0.10~0.30	0.50~3.00
		160408-CP							●	●																		0.12~0.30	0.50~3.00
		160412-CP							●	●																		0.13~0.30	0.80~3.00
		220408-CP							●	●																		0.15~0.35	0.80~4.00
		220412-CP							●	●																		0.18~0.35	1.00~4.00

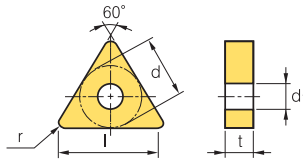
↻ Cutting edge geometry A37~A49
 ↻ Recommended chip breaker B04~B15
 ↻ Code system B34~B35
 ● : Stock item

Available tool holders					
Designation	Page	Designation	Page	Designation	Page
MTENN	B187	PTFNR/L	B177	WTJNR/L	B179
MTFNR/L	B187	PTGNR/L	B178	WTXNR/L	B179
MTGNR/L	B188	PTTNR/L	B178		
MTJNR/L	B188	WTENN	B179		





Triangular 60° Negative



Size	Dimensions (mm)		
	d	t	d ₁
11	6.35	3.18	2.40
16	9.525	3.18~4.76	3.81
22	12.7	4.76	5.16
27	15.875	6.35	6.35

Workpiece	Material																Machining types						
	Steel	P	●	✱	●	✱	●	✱	●	✱	●	✱	●	✱	●	✱	●	✱	●	✱	●	✱	
Stainless steel	M	●	✱	●	✱	●	✱	●	✱	●	✱	●	✱	●	✱	●	✱	●	✱	●	✱	●	✱
Cast iron	K	●	✱	●	✱	●	✱	●	✱	●	✱	●	✱	●	✱	●	✱	●	✱	●	✱	●	✱
Non-ferrous metal	N	●	✱	●	✱	●	✱	●	✱	●	✱	●	✱	●	✱	●	✱	●	✱	●	✱	●	✱
Heat resistant alloy, Titanium alloy	S	●	✱	●	✱	●	✱	●	✱	●	✱	●	✱	●	✱	●	✱	●	✱	●	✱	●	✱
Hardened steel	H	●	✱	●	✱	●	✱	●	✱	●	✱	●	✱	●	✱	●	✱	●	✱	●	✱	●	✱

Inserts	Designation	Cermets		Coated		Coated										Uncoated		Cutting Condition								
		CN1500	CN2500	CC1500	CC2500	NC3215	NC3225	NC3120	NC3030	NC3235	NC5330	NC6310	NC6315	NC9115	NC9125	NC9135	PC5300	PC5400	PC8105	PC8110	PC8115	PC9030	H01	H05	f _n (mm/rev)	a _p (mm)
Medium to finishing VC	TNMG 160404-VC					●	●				●														0.10~0.35	0.30~2.00
	160408-VC					●	●				●														0.15~4.00	0.50~3.00
	160412-VC					●	●				●														0.15~4.50	0.50~3.00
	220408-VC					●	●																		0.15~0.40	0.50~3.00
	220412-VC					●	●																		0.15~0.45	0.50~3.00
Medium cutting HM	TNMG 110308-HM							●																	0.17~0.40	1.50~3.00
	160404-HM						●	●	●						●								●		0.05~0.30	0.90~4.00
	160408-HM					●	●	●	●														●		0.10~0.50	1.00~4.00
	160412-HM																						●		0.13~0.60	1.30~4.00
	220404-HM						●																		0.15~0.45	0.60~5.00
	220408-HM						●	●	●																0.18~0.48	0.80~5.80
Medium cutting MP	TNMG 110308-MP					●	●																		0.15~0.42	0.50~3.50
	160404-MP					●	●			●	●		●	●	●			●	●						0.10~0.40	0.40~3.50
	160408-MP					●	●			●	●		●	●	●			●	●						0.15~0.45	0.50~4.00
	160412-MP					●	●			●	●		●	●	●			●	●						0.15~0.50	0.80~4.50
	160416-MP																								0.18~0.50	1.00~4.50
	220404-MP					●	●			●	●		●	●	●										0.10~0.35	0.40~5.00
	220408-MP					●	●			●	●		●	●	●										0.15~0.45	0.50~5.50
	220412-MP					●	●			●	●		●	●	●										0.15~0.50	0.80~6.00
	220416-MP					●	●			●	●		●	●	●										0.20~0.55	1.00~6.00
	270612-MP																								0.28~0.60	1.20~8.00
Medium cutting VM	TNMG 110308-VM																								0.05~0.30	0.80~4.00
	160404-VM	●					●	●		●				●	●										0.05~0.30	0.90~5.00
	160408-VM	●	●			●	●	●	●		●			●	●							●			0.10~0.50	1.00~5.00
	160412-VM	●				●	●							●	●										0.13~0.60	1.30~5.00
	220404-VM													●	●										0.05~0.30	0.90~6.60
	220408-VM						●			●				●	●			●							0.10~0.50	1.00~6.60
	220412-VM																								0.13~0.60	1.30~6.60

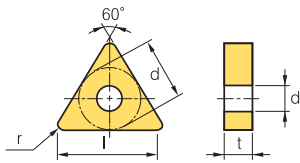
➔ Cutting edge geometry **A37~A49**
 ➔ Recommended chip breaker **B04~B15**
 ➔ Code system **B34~B35**
 ● : Stock item

Available tool holders					
Designation	Page	Designation	Page	Designation	Page
MTENN	B187	PTFNR/L	B177	WTJNR/L	B179
MTFNR/L	B187	PTGNR/L	B178	WTXNR/L	B179
MTGNR/L	B188	PTTNR/L	B178		
MTJNR/L	B188	WTENN	B179		

B Turning Insert (Negative)

TN ○ ○

Triangular 60° Negative



Dimensions (mm)			
Size	d	t	d ₁
11	6.35	3.18	2.40
16	9.525	4.76	3.81
22	12.7	4.76	5.16
27	15.875	6.35	6.35
33	19.05	9.52	7.93

Workpiece	Material	Grade	Machining types															
			●	✱	●	✱	●	✱	●	✱	●	✱	●	✱	●	✱		
Steel		P	●	✱	●	✱	●	✱	●	✱	●	✱	●	✱	●	✱		
Stainless steel		M																
Cast iron		K	●	✱	●	✱	●	✱	●	✱	●	✱	●	✱	●	✱	●	✱
Non-ferrous metal		N																
Heat resistant alloy, Titanium alloy		S																
Hardened steel		H																

Inserts	Designation	Cermet		Coated		Coated														Uncoated		Cutting Condition					
		CN1500	CN2500	CC1500	CC2500	NC3215	NC3225	NC3120	NC3030	NC3235	NC5330	NC6310	NC6315	NC9115	NC9125	NC9135	PC5300	PC5400	PC8105	PC8110	PC8115	PC9030	H01	H05	f _n (mm/rev)	a _p (mm)	
Medium to roughing B25	TNMG 110308-B25																									0.17-0.40	1.50-3.00
	160404-B25	●	●			●	●		●		●															0.17-0.45	2.00-3.50
	160408-B25	●	●			●	●		●		●											●				0.17-0.55	2.00-3.50
	160412-B25		●			●	●		●		●															0.25-0.55	2.00-3.50
	160416-B25					●	●		●		●															0.30-0.60	2.50-3.00
	220404-B25					●	●		●		●															0.17-0.45	1.50-5.00
	220408-B25					●	●		●		●															0.17-0.55	2.00-5.00
	220412-B25					●	●		●		●															0.25-0.55	2.00-5.00
	220416-B25					●	●		●		●															0.30-0.60	2.00-5.00
	220424-B25																									0.35-0.70	3.00-7.00
	220432-B25																									0.40-0.75	3.50-7.00
	270608-B25									●																0.17-0.55	2.00-5.00
	270612-B25								●		●		●													0.25-0.55	3.00-7.00
	270616-B25								●		●		●													0.30-0.60	3.00-7.00
	330716-B25								●	●																0.35-0.70	3.00-9.00
330924-B25																									0.40-0.80	3.00-9.00	
Roughing GR	TNMG 160408-GR							●		●																0.20-0.50	1.00-7.00
	160412-GR							●																		0.23-0.54	1.20-8.00
	220408-GR							●		●		●														0.22-0.61	1.10-7.80
	220412-GR							●	●	●																0.28-0.78	1.20-7.80
	220416-GR							●		●																0.31-0.75	1.50-7.80
	270608-GR							●		●																0.31-0.75	1.50-7.80
	270612-GR							●	●	●																0.31-0.75	1.50-7.80
	270616-GR							●		●																0.36-1.00	1.60-7.80
330924-GR									●																0.40-1.00	2.00-9.00	
Finishing SC	TNGG 160402R-SC																									0.03-0.20	0.10-1.50
	160404R-SC																									0.05-0.25	0.30-2.00
	160402L-SC																									0.03-0.20	0.10-1.50
	160404L-SC																									0.05-0.25	0.30-2.00
Medium to finishing VQ [Cermet]	TNMG 110304-VQ																									0.05-0.30	0.50-3.00
	160404-VQ	●	●	●	●																					0.05-0.30	0.80-3.50
	160408-VQ	●	●	●	●																					0.08-0.40	0.80-3.50
	160412-VQ																									0.10-0.40	0.80-3.50
	220404-VQ																									0.05-0.35	0.80-4.00

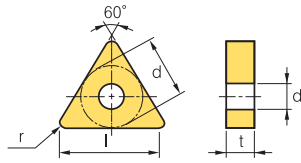
Cutting edge geometry **A37~A49**
 Recommended chip breaker **B04~B15**
 Code system **B34~B35**
● : Stock item

Available tool holders					
Designation	Page	Designation	Page	Designation	Page
MTENN	B187	PTFNR/L	B177	WTJNR/L	B179
MTFNR/L	B187	PTGNR/L	B178	WTXNR/L	B179
MTGNR/L	B188	PTTNR/L	B178		
MTJNR/L	B188	WTENN	B179		





Triangular 60° Negative



Dimensions (mm)			
Size	d	t	d ₁
11	6.35	3.18	2.40
16	9.525	3.18-4.76	3.81
22	12.7	4.76	5.16
27	15.875	6.35	6.35
33	19.05	9.52	7.93

Workpiece	Material	Grade	Machining types													
			●	*	●	*	●	*	●	*	●	*				
Steel	P		●	*	●	*	●	*	●	*	●	*	●	*	●	*
Stainless steel	M															
Cast iron	K		●	*	●	*	●	*	●	*	●	*	●	*	●	*
Non-ferrous metal	N															
Heat resistant alloy, Titanium alloy	S															
Hardened steel	H															

● Continuous cutting
* General cutting
* Interrupted cutting

Inserts	Designation	Cermets		Coated										Uncoated		Cutting Condition													
		CN1500	CN2500	CC1500	CC2500	NC3215	NC3225	NC3120	NC3030	NC3235	NC5330	NC6310	NC6315	NC9115	NC9125	NC9135	PC5300	PC5400	PC8105	PC8110	PC8115	PC9030	H01	H05	f _n (mm/rev)	a _p (mm)			
Medium cutting	TNGG	110304R																								0.05~0.30	0.50~2.50		
		160402R																									0.08~0.30	0.50~3.50	
		160404R	●																								0.12~0.30	1.00~3.50	
		160408R																									0.15~0.35	1.30~3.50	
		220404R																									0.12~0.30	1.00~5.00	
		220408R																									0.15~0.35	1.30~5.00	
		220412R																									0.17~0.40	1.50~5.00	
		110304L																										0.05~0.30	0.50~2.50
		160402L																										0.08~0.30	0.50~3.50
		160404L	●																									0.12~0.30	1.00~3.50
		160408L																										0.15~0.35	1.30~3.50
		220404L																										0.12~0.30	1.00~5.00
		220408L																										0.15~0.35	1.30~5.00
220412L																										0.17~0.40	1.50~5.00		
Medium cutting	TNMG	160404-MK																									0.05~0.30	0.90~3.50	
		160408-MK											●	●													0.10~0.50	1.00~4.00	
		160412-MK												●													0.12~0.60	1.20~4.50	
		160416-MK													●												0.13~0.60	1.20~4.50	
		220404-MK																									0.17~0.45	1.50~5.00	
		220408-MK																									0.21~0.50	1.30~5.50	
		220412-MK																									0.23~0.52	1.40~5.50	
		220416-MK																										0.25~0.53	1.60~6.00
		270612-MK																										0.25~0.55	3.00~7.00
Roughing	TNMA	110308																								0.05~0.30	0.50~3.00		
		160404																									0.10~0.30	1.00~4.00	
		160408																									0.10~0.40	1.00~4.00	
		160412																									0.10~0.50	1.50~4.50	
		160416																									0.15~0.55	1.50~4.50	
		220404																									0.10~0.35	1.00~4.00	
		220408																									0.15~0.40	1.50~5.00	
		220412																									0.20~0.50	1.50~5.00	
		220416																									0.25~0.55	1.50~5.00	
		220420																									0.30~0.65	2.00~5.00	
		220432																									0.35~0.70	2.00~5.00	
		270608																									0.20~0.45	2.00~7.00	
		270612																									0.25~0.55	3.00~7.00	
		270616																									0.30~0.65	3.00~7.00	
		330924																									0.35~0.75	3.00~9.00	

Cutting edge geometry **A37~A49** Recommended chip breaker **B04~B15** Code system **B34~B35** ● : Stock item

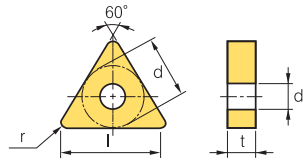
Available tool holders					
Designation	Page	Designation	Page	Designation	Page
MTENN	B187	PTFNR/L	B177	WTJNR/L	B179
MTFNR/L	B187	PTGNR/L	B178	WTXNR/L	B179
MTGNR/L	B188	PTTNR/L	B178		
MTJNR/L	B188	WTENN	B179		



B Turning Insert (Negative)

TN ○ ○

Triangular 60° Negative



Dimensions (mm)			
Size	d	t	d ₁
11	6.35	3.18	2.40
16	9.525	4.76	3.81
22	12.7	4.76	5.16
27	15.875	6.35	6.35

Workpiece	Material	Grade	Machining types															
			●	✱	●	✱	●	✱	●	✱	●	✱	●	✱	●	✱	●	✱
Steel		P	●	✱	●	✱	●	✱	●	✱	●	✱	●	✱	●	✱	●	✱
Stainless steel		M	●	✱	●	✱	●	✱	●	✱	●	✱	●	✱	●	✱	●	✱
Cast iron		K	●	✱	●	✱	●	✱	●	✱	●	✱	●	✱	●	✱	●	✱
Non-ferrous metal		N																
Heat resistant alloy, Titanium alloy		S																
Hardened steel		H																

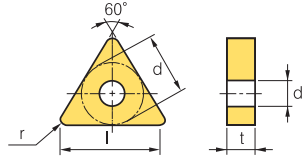
Inserts	Designation	Cermet		Coated		Coated										Uncoated		Cutting Condition												
		CN1500	CN2500	CC1500	CC2500	NC3215	NC3225	NC3120	NC3030	NC3235	NC5330	NC6310	NC6315	NC9115	NC9125	NC9135	PC5300	PC5400	PC8105	PC8110	PC8115	PC9030	H01	H05	f _n (mm/rev)	a _p (mm)				
Roughing		TNGA	110302																							0.05-0.30	0.20-3.00			
			110304																									0.05-0.30	0.40-3.00	
			160304																									0.10-0.35	0.40-4.00	
			160402																									0.10-0.30	0.20-4.00	
			160404																									0.10-0.35	0.40-5.00	
			160408																									0.12-0.40	0.50-5.00	
			220304																									0.10-0.35	0.50-5.00	
			220402																										0.05-0.30	0.20-3.00
			220404																										0.10-0.35	0.40-5.00
			220408																										0.10-0.40	0.50-5.00
			220412																										0.12-0.45	1.00-5.50
			270612																										0.12-0.45	1.00-7.00
			270624																										0.20-0.55	2.00-7.00
Roughing		TNMG	160408-RK																							0.23-0.53	1.50-5.00			
			160412-RK																								0.28-0.53	1.80-5.00		
			160416-RK																									0.28-0.53	1.80-5.00	
			220408-RK																									0.23-0.53	1.50-6.00	
			220412-RK																										0.28-0.53	1.80-6.00
			220416-RK																										0.28-0.63	2.00-6.00
Roughing		TNMG	160404-VR																							0.20-0.50	0.80-7.00			
			160408-VR																								0.25-0.55	1.20-7.00		
			160412-VR																								0.35-0.65	1.70-7.00		
			160416-VR																								0.35-0.70	2.00-10.0		
			220408-VR																									0.35-0.70	2.00-10.0	
			220412-VR																									0.35-0.70	2.00-10.0	
			220416-VR																									0.35-0.75	2.20-10.0	
Medium cutting		TNMG	160404-MM																							0.10-0.40	0.50-4.80			
			160408-MM																								0.12-0.45	0.50-4.80		
			160412-MM																								0.18-0.65	0.50-4.80		
			160416-MM																								0.18-0.65	0.50-4.80		
			220404-MM																									0.10-0.40	0.50-6.50	
			220408-MM																									0.12-0.45	0.50-6.50	
			220412-MM																									0.15-0.60	0.50-6.50	
			220416-MM																									0.18-0.65	0.50-6.50	

➤ Cutting edge geometry A37~A49
➤ Recommended chip breaker B04~B15
➤ Code system B34~B35
● : Stock item

Available tool holders					
Designation	Page	Designation	Page	Designation	Page
MTENN	B187	PTFNR/L	B177	WTJNR/L	B179
MTFNR/L	B187	PTGNR/L	B178	WTXNR/L	B179
MTGNR/L	B188	PTTNR/L	B178		
MTJNR/L	B188	WTENN	B179		



TN



Dimensions (mm)			
Size	d	t	d ₁
16	9.525	4.76	3.81
22	12.7	4.76	5.16

Triangular 60° Negative

Workpiece	Steel	P	● * ● * ● * ● * ● * ● * ● * ● * ● * ● * ● * ● *																Machining types	
	Stainless steel	M	● * ● * ● * ● * ● * ● * ● * ● * ● * ● * ● * ● *																●	●
Cast iron	K	● * ● * ● * ● * ● * ● * ● * ● * ● * ● * ● * ● *																●	●	
Non-ferrous metal	N	● * ● * ● * ● * ● * ● * ● * ● * ● * ● * ● * ● *																●	●	
Heat resistant alloy, Titanium alloy	S	● * ● * ● * ● * ● * ● * ● * ● * ● * ● * ● * ● *																●	●	
Hardened steel	H	● * ● * ● * ● * ● * ● * ● * ● * ● * ● * ● * ● *																●	●	

● Continuous cutting ● General cutting * Interrupted cutting

Inserts	Designation	Cermet		Coated		Coated												Uncoated		Cutting Condition									
		CN1500	CN2500	CC1500	CC2500	NC3215	NC3225	NC3120	NC3030	NC3235	NC5330	NC6315	NC9115	NC9125	NC9135	PC5300	PC5400	PC8105	PC8110	PC8115	PC8120	PC9030	H01	H05	f _n (mm/rev)	a _p (mm)			
Roughing		TNMG	160404-RM	●	●	●	●	●	●	●	●	●	●	●	●	●	●	●	●	●	●	●	●	●	●	0.10~0.50	2.00~5.50		
			160408-RM	●	●	●	●	●	●	●	●	●	●	●	●	●	●	●	●	●	●	●	●	●	●	●	0.15~0.55	2.00~5.50	
			160412-RM	●	●	●	●	●	●	●	●	●	●	●	●	●	●	●	●	●	●	●	●	●	●	●	●	0.20~0.60	2.00~5.50
			220408-RM	●	●	●	●	●	●	●	●	●	●	●	●	●	●	●	●	●	●	●	●	●	●	●	●	0.10~0.50	2.00~7.50
			220412-RM	●	●	●	●	●	●	●	●	●	●	●	●	●	●	●	●	●	●	●	●	●	●	●	●	0.15~0.55	2.00~7.50
			220416-RM	●	●	●	●	●	●	●	●	●	●	●	●	●	●	●	●	●	●	●	●	●	●	●	●	0.25~0.70	2.00~7.50
Medium to finishing		TNMG	160404-VP2	●	●	●	●	●	●	●	●	●	●	●	●	●	●	●	●	●	●	●	●	●	●	0.05~0.30	0.10~3.00		
			160408-VP2	●	●	●	●	●	●	●	●	●	●	●	●	●	●	●	●	●	●	●	●	●	●	●	0.10~0.45	0.50~5.00	
			160412-VP2	●	●	●	●	●	●	●	●	●	●	●	●	●	●	●	●	●	●	●	●	●	●	●	0.13~0.55	0.80~3.30	
			220404-VP2	●	●	●	●	●	●	●	●	●	●	●	●	●	●	●	●	●	●	●	●	●	●	●	0.05~0.30	0.80~5.00	
			220408-VP2	●	●	●	●	●	●	●	●	●	●	●	●	●	●	●	●	●	●	●	●	●	●	●	●	0.10~0.40	0.80~5.00
Medium cutting		TNMG	160404-VP3	●	●	●	●	●	●	●	●	●	●	●	●	●	●	●	●	●	●	●	●	●	●	●	0.05~0.30	0.10~3.00	
			160408-VP3	●	●	●	●	●	●	●	●	●	●	●	●	●	●	●	●	●	●	●	●	●	●	●	●	0.10~0.45	0.50~5.00
			160412-VP3	●	●	●	●	●	●	●	●	●	●	●	●	●	●	●	●	●	●	●	●	●	●	●	●	0.20~0.40	0.50~3.50
			220404-VP3	●	●	●	●	●	●	●	●	●	●	●	●	●	●	●	●	●	●	●	●	●	●	●	●	0.20~0.30	0.80~4.00
			220408-VP3	●	●	●	●	●	●	●	●	●	●	●	●	●	●	●	●	●	●	●	●	●	●	●	●	0.25~0.35	0.80~5.00
			220412-VP3	●	●	●	●	●	●	●	●	●	●	●	●	●	●	●	●	●	●	●	●	●	●	●	●	0.30~0.40	1.00~5.00
			220416-VP3	●	●	●	●	●	●	●	●	●	●	●	●	●	●	●	●	●	●	●	●	●	●	●	●	0.30~0.40	1.00~5.00
Medium cutting		TNGG	160404-VP3	●	●	●	●	●	●	●	●	●	●	●	●	●	●	●	●	●	●	●	●	●	●	0.05~0.30	0.10~3.00		
			160408-VP3	●	●	●	●	●	●	●	●	●	●	●	●	●	●	●	●	●	●	●	●	●	●	●	0.10~0.45	0.50~5.00	
Roughing		TNMG	160408-VP4	●	●	●	●	●	●	●	●	●	●	●	●	●	●	●	●	●	●	●	●	●	●	0.15~0.35	1.00~4.00		
			160412-VP4	●	●	●	●	●	●	●	●	●	●	●	●	●	●	●	●	●	●	●	●	●	●	●	0.20~0.40	1.00~4.00	
Medium to finishing		TNMG	160404-HA	●	●	●	●	●	●	●	●	●	●	●	●	●	●	●	●	●	●	●	●	●	●	0.05~0.30	0.80~3.50		
			160408-HA	●	●	●	●	●	●	●	●	●	●	●	●	●	●	●	●	●	●	●	●	●	●	●	0.10~0.40	0.80~3.50	
			160412-HA	●	●	●	●	●	●	●	●	●	●	●	●	●	●	●	●	●	●	●	●	●	●	●	0.13~0.55	0.80~3.50	
			220408-HA	●	●	●	●	●	●	●	●	●	●	●	●	●	●	●	●	●	●	●	●	●	●	●	0.10~0.40	0.80~5.30	

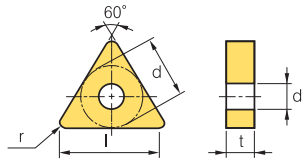
↻ Cutting edge geometry A37~A49
↻ Recommended chip breaker B04~B15
↻ Code system B34~B35
● : Stock item

Available tool holders					
Designation	Page	Designation	Page	Designation	Page
MTENN	B187	PTFNR/L	B177	WTJNR/L	B179
MTFNR/L	B187	PTGNR/L	B178	WTXNR/L	B179
MTGNR/L	B188	PTTNR/L	B178		
MTJNR/L	B188	WTENN	B179		



B Turning Insert (Negative)

TN



Dimensions (mm)			
Size	d	t	d ₁
11	6.35	3.18	2.40
16	9.525	4.76	3.81
22	12.7	4.76	5.16
27	15.875	6.35	6.35

Triangular 60° Negative

Workpiece	Machining types																
	P	M	K	N	S	H	●	⊛	⊚	⊙	⊘	⊙	⊘	⊙	⊘	⊙	⊘
Steel	●	⊛	●	⊚	●	⊛	●	⊚	●	⊛	●	⊚	●	⊛	●	⊚	●
Stainless steel	●	⊛	●	⊚	●	⊛	●	⊚	●	⊛	●	⊚	●	⊛	●	⊚	●
Cast iron	●	⊛	●	⊚	●	⊛	●	⊚	●	⊛	●	⊚	●	⊛	●	⊚	●
Non-ferrous metal	●	⊛	●	⊚	●	⊛	●	⊚	●	⊛	●	⊚	●	⊛	●	⊚	●
Heat resistant alloy, Titanium alloy	●	⊛	●	⊚	●	⊛	●	⊚	●	⊛	●	⊚	●	⊛	●	⊚	●
Hardened steel	●	⊛	●	⊚	●	⊛	●	⊚	●	⊛	●	⊚	●	⊛	●	⊚	●

Inserts	Designation	Cermets		Coated		Coated													Uncoated		Cutting Condition								
		CN1500	CN2500	CC1500	CC2500	NC3215	NC3225	NC3120	NC3030	NC3235	NC5330	NC6310	NC6315	NC9115	NC9125	NC9135	PC5300	PC5400	PC8105	PC8110	PC8115	PC9030	H01	H05	f _n (mm/rev)	a _p (mm)			
Finishing	[Wiper]	TNMG 160404-VW	●	●	●	●	●	●	●	●	●	●	●	●	●	●	●	●	●	●	●	●	●	●	●	0.10-0.35	0.30-3.00		
			160408-VW	●	●	●	●	●	●	●	●	●	●	●	●	●	●	●	●	●	●	●	●	●	●	●	0.10-0.40	0.30-3.00	
Medium cutting	[Wiper]	TNMG 160408-LW	●	●	●	●	●	●	●	●	●	●	●	●	●	●	●	●	●	●	●	●	●	●	●	0.15-0.50	0.70-4.50		
			160412-LW	●	●	●	●	●	●	●	●	●	●	●	●	●	●	●	●	●	●	●	●	●	●	●	0.20-0.60	1.00-5.00	
Medium cutting		TNGN	110302	●	●	●	●	●	●	●	●	●	●	●	●	●	●	●	●	●	●	●	●	●	●	0.05-0.25	0.20-2.50		
			110304	●	●	●	●	●	●	●	●	●	●	●	●	●	●	●	●	●	●	●	●	●	●	●	0.10-0.30	0.50-2.50	
			110308	●	●	●	●	●	●	●	●	●	●	●	●	●	●	●	●	●	●	●	●	●	●	●	0.10-0.30	0.80-2.50	
			160302	●	●	●	●	●	●	●	●	●	●	●	●	●	●	●	●	●	●	●	●	●	●	●	●	0.05-0.30	0.20-3.00
			160304	●	●	●	●	●	●	●	●	●	●	●	●	●	●	●	●	●	●	●	●	●	●	●	●	0.10-0.30	0.50-4.00
			160308	●	●	●	●	●	●	●	●	●	●	●	●	●	●	●	●	●	●	●	●	●	●	●	●	0.10-0.40	0.80-4.00
			160404	●	●	●	●	●	●	●	●	●	●	●	●	●	●	●	●	●	●	●	●	●	●	●	●	0.10-0.40	0.50-4.00
			160408	●	●	●	●	●	●	●	●	●	●	●	●	●	●	●	●	●	●	●	●	●	●	●	●	0.10-0.40	1.00-4.00
			160412	●	●	●	●	●	●	●	●	●	●	●	●	●	●	●	●	●	●	●	●	●	●	●	●	0.10-0.50	1.50-4.50
			220404	●	●	●	●	●	●	●	●	●	●	●	●	●	●	●	●	●	●	●	●	●	●	●	●	0.10-0.35	1.00-4.00
			220408	●	●	●	●	●	●	●	●	●	●	●	●	●	●	●	●	●	●	●	●	●	●	●	●	0.15-0.40	1.50-5.00
			220412	●	●	●	●	●	●	●	●	●	●	●	●	●	●	●	●	●	●	●	●	●	●	●	●	0.20-0.50	1.50-5.00
			220416	●	●	●	●	●	●	●	●	●	●	●	●	●	●	●	●	●	●	●	●	●	●	●	●	0.25-0.55	1.50-5.00
220424	●	●	●	●	●	●	●	●	●	●	●	●	●	●	●	●	●	●	●	●	●	●	●	●	0.30-0.65	2.00-5.00			
270630	●	●	●	●	●	●	●	●	●	●	●	●	●	●	●	●	●	●	●	●	●	●	●	●	0.35-0.70	2.00-5.00			
Medium to finishing	[Shaft]	TNMX	160404R-SR	●	●	●	●	●	●	●	●	●	●	●	●	●	●	●	●	●	●	●	●	●	●	0.10-0.35	0.70-3.50		
			160408R-SR	●	●	●	●	●	●	●	●	●	●	●	●	●	●	●	●	●	●	●	●	●	●	●	0.12-0.40	1.00-3.50	
			160404L-SR	●	●	●	●	●	●	●	●	●	●	●	●	●	●	●	●	●	●	●	●	●	●	●	0.10-0.35	0.70-3.50	
			160408L-SR	●	●	●	●	●	●	●	●	●	●	●	●	●	●	●	●	●	●	●	●	●	●	●	0.12-0.40	1.00-3.50	
Medium cutting	[Shaft]	TNMX	160404R-SH	●	●	●	●	●	●	●	●	●	●	●	●	●	●	●	●	●	●	●	●	●	●	0.15-0.30	0.50-4.00		
			160408R-SH	●	●	●	●	●	●	●	●	●	●	●	●	●	●	●	●	●	●	●	●	●	●	●	0.15-0.45	1.00-4.00	
			160404L-SH	●	●	●	●	●	●	●	●	●	●	●	●	●	●	●	●	●	●	●	●	●	●	●	0.15-0.30	0.50-4.00	
			160408L-SH	●	●	●	●	●	●	●	●	●	●	●	●	●	●	●	●	●	●	●	●	●	●	●	0.15-0.45	1.00-4.00	

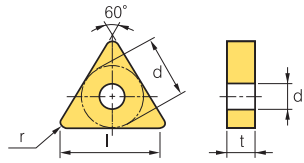
Cutting edge geometry A37~A49
 Recommended chip breaker B04~B15
 Code system B34~B35
 ● : Stock item

Available tool holders					
Designation	Page	Designation	Page	Designation	Page
MTENN	B187	PTFNR/L	B177	WTJNR/L	B179
MTFNR/L	B187	PTGNR/L	B178	WTXNR/L	B179
MTGNR/L	B188	PTTNR/L	B178		
MTJNR/L	B188	WTENN	B179		



TN

Triangular 60° Negative



Dimensions (mm)			
Size	d	t	d ₁
16	9.525	4.76	3.81
22	12.7	4.76	5.16
27	15.875	6.35	6.35
33	19.05	7.94~9.52	7.93

Workpiece	Machining types											
	P	M	K	N	S	H	●	⊙	⊚	⊛	⊜	⊝
Steel	●	●	●	●	●	●	●	●	●	●	●	●
Stainless steel	●	●	●	●	●	●	●	●	●	●	●	●
Cast iron	●	●	●	●	●	●	●	●	●	●	●	●
Non-ferrous metal	●	●	●	●	●	●	●	●	●	●	●	●
Heat resistant alloy, Titanium alloy	●	●	●	●	●	●	●	●	●	●	●	●
Hardened steel	●	●	●	●	●	●	●	●	●	●	●	●

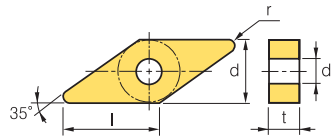
Inserts	Designation	Cermet		Coated														Uncoated		Cutting Condition							
		CN1500	CN2500	CC1500	CC2500	NC3215	NC3225	NC3120	NC3030	NC3235	NC5330	NC6310	NC6315	NC9115	NC9125	NC9135	PC5300	PC5400	PC8105	PC8110	PC8115	PC9030	H01	H05	f _n (mm/rev)	a _p (mm)	
Medium to roughing	TNMX 160402R		●																						0.10~0.30	0.50~3.00	
	160404R					●	●	●		●																0.12~0.30	1.00~3.50
	160408R					●	●	●																		0.15~0.35	1.30~3.40
	220404R																									0.12~0.30	1.00~5.00
	220408R																									0.15~0.35	1.30~5.00
	160404L					●	●	●																		0.12~0.30	1.00~3.50
	160408L						●	●																		0.15~0.35	1.30~3.40
Roughing	TNMM 220408-GR																								0.22~0.61	1.10~7.80	
	220412-GR																									0.28~0.78	1.20~7.80
	220416-GR																									0.31~0.75	1.50~7.80
Heavy	TNMM 160408-GH																								0.20~0.50	1.00~7.00	
	220408-GH																								0.25~0.60	1.30~7.00	
	220412-GH					●																			0.20~0.50	1.00~8.00	
	220416-GH																								0.25~0.60	1.30~8.00	
	270616-GH																								0.32~0.70	1.80~8.00	
	270624-GH																								0.35~0.50	1.80~13.00	
	330924-GH																								0.35~0.70	2.30~13.00	

➡ Cutting edge geometry A37~A49
➡ Recommended chip breaker B04~B15
➡ Code system B34~B35
● : Stock item

Available tool holders					
Designation	Page	Designation	Page	Designation	Page
MTENN	B187	PTFNR/L	B177	WTJNR/L	B179
MTFNR/L	B187	PTGNR/L	B178	WTXNR/L	B179
MTGNR/L	B188	PTTNR/L	B178		
MTJNR/L	B188	WTENN	B179		

B Turning Insert (Negative)

VN○○○



Dimensions (mm)			
Size	d	t	d ₁
16	9.525	4.76	3.81

Rhombic **35° Negative**

Workpiece	Material											Machining types			
	Steel	Stainless steel	Cast iron	Non-ferrous metal	Heat resistant alloy, Titanium alloy	Hardened steel	P	M	K	N	S	H	Continuous cutting	General cutting	Interrupted cutting
							●	●	●	●	●	●	●	●	●

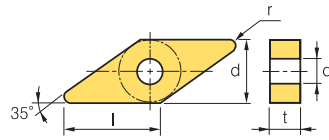
Inserts	Designation	Cermet		Coated		Coated											Uncoated		Cutting Condition										
		CN1500	CN2500	CC1500	CC2500	NC3215P	NC3225P	NC3215	NC3225	NC3120	NC3030	NC3235	NC5330	NC6310	NC6315	NC9115	NC9125	NC9135	PC8105	PC8110	PC8115	PC9030	H01	H05	f _n (mm/rev)	a _p (mm)			
Finishing		VNMG		160404-VB		●	●	●	●	●	●	●	●	●	●	●	●	●	●	●	●	●	●	●	●	0.10-0.35	0.30-1.50		
		160408-VB		●	●	●	●	●	●	●	●	●	●	●	●	●	●	●	●	●	●	●	●	●	●	0.15-0.45	0.50-2.00		
		160412-VB		●	●	●	●	●	●	●	●	●	●	●	●	●	●	●	●	●	●	●	●	●	●	●	0.20-0.45	0.80-2.50	
Finishing		VNMG		160402-VF						●															0.06-0.20	0.30-1.00			
		160404-VF		●					●			●													●	0.08-0.30	0.50-1.50		
		160408-VF		●						●	●		●														0.10-0.40	0.50-1.50	
		160412-VF		●																							0.15-0.50	0.50-1.50	
Finishing		VNMG		160404-VL		●	●			●	●			●												0.05-0.20	0.10-1.00		
		160408-VL		●	●					●	●			●													0.10-0.25	0.20-1.50	
		160412-VL		●	●					●																	0.15-0.30	0.50-2.00	
Medium to finishing		VNMG		160404-LP		●	●				●	●														0.10-0.35	0.30-1.50		
		160408-LP		●	●					●	●																0.10-0.40	0.50-2.00	
		160412-LP		●	●					●	●																	0.10-0.45	0.80-2.50
Medium to finishing		VNMG		160404-CP		●	●			●	●															0.10-0.35	0.5-3.0		
		160408-CP		●	●					●	●																0.12-0.30	0.5-3.0	
		160412-CP		●	●					●	●																	0.13-0.30	0.8-3.0
Medium to finishing		VNMG		160404-VC		●	●				●	●														0.10-0.35	0.30-2.00		
		160408-VC		●	●					●	●																0.15-4.00	0.50-3.00	
		160412-VC		●	●					●	●																	0.15-0.40	0.80-3.00
Medium cutting		VNMG		160404-HM		●	●					●	●									●				0.13-0.40	0.80-3.80		
		160408-HM		●	●					●	●	●											●				0.20-0.45	0.80-4.50	
		160412-HM		●	●					●																		0.10-0.60	1.00-4.00
Medium cutting		VNMG		160404-MP		●	●				●	●			●	●	●	●	●	●	●	●	●	●	●	0.10-0.40	0.40-3.50		
		160408-MP		●	●					●	●			●	●	●	●	●	●	●	●	●	●	●	●		0.15-0.45	0.50-4.00	
		160412-MP		●	●					●	●			●														0.15-0.50	0.80-4.50
		160416-MP		●	●									●														0.18-0.50	1.00-4.50

Cutting edge geometry **A37~A49**
 Recommended chip breaker **B04~B15**
 Code system **B34~B35**
 ● : Stock item

Available tool holders			
Designation	Page	Designation	Page
MVJNR/L	B188	MVVNN	B189
MVQNR/L	B189	MVUNR/L	B214



VN



Dimensions (mm)			
Size	d	t	d ₁
16	9.525	4.76	3.81
22	12.7	4.76	5.16

Rhombic 35° Negative

Workpiece	Steel	P																	Machining types
	Stainless steel	M																	
Cast iron	K																	● Continuous cutting ● General cutting # Interrupted cutting	
Non-ferrous metal	N																		
Heat resistant alloy, Titanium alloy	S																		
Hardened steel	H																		

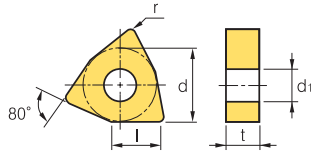
Inserts	Designation	Cermet		Coated														Uncoated		Cutting Condition								
		CN1500	CN2500	CC1500	CC2500	NC3215	NC3225	NC3120	NC3030	NC3235	NC5330	NC6310	NC6315	NC9115	NC9125	NC9135	PC5300	PC5400	PC8105	PC8110	PC8115	PC9030	H01	H05	f _n (mm/rev)	a _p (mm)		
Medium cutting VM	VNMG 160404-VM	●						●	●								●	●								0.08~0.45	0.50~3.50	
	VNMG 160408-VM	●				●	●	●	●								●	●		●	●					0.10~0.50	1.00~4.00	
	VNMG 160412-VM																									0.20~0.50	1.50~4.00	
	VNMG 220404-VM																										0.08~0.45	1.00~5.00
	VNMG 220408-VM																										0.10~0.50	1.50~5.00
Medium to finishing VQ [Cermet]	VNMG 160404-VQ	●	●	●	●																						0.10~0.40	0.50~3.50
	VNMG 160408-VQ	●	●	●	●																						0.12~0.45	0.50~3.50
	VNMG 160412-VQ																										0.15~0.45	0.80~3.50
Medium cutting MK new	VNMG 160404-MK																										0.08~0.45	0.50~3.00
	VNMG 160408-MK												●	●													0.10~0.50	1.00~3.50
	VNMG 160412-MK												●														0.20~0.50	1.50~4.00
Medium cutting MM new	VNMG 160404-MM																										0.10~0.40	0.50~4.80
	VNMG 160408-MM																										0.12~0.45	0.50~4.80
	VNMG 160412-MM																										0.15~0.60	0.50~4.00
Medium cutting RM new	VNMG 160404-RM																										0.10~0.50	2.00~5.00
	VNMG 160408-RM																										0.15~0.55	2.00~5.00
	VNMG 160412-RM																										0.20~0.60	2.00~5.00
Medium cutting VP3	VNMG 160404-VP3																						●	●	0.05~0.30	0.10~3.00		
	VNMG 160408-VP3																						●	●	0.10~0.45	0.50~5.00		
	VNMG 160412-VP3																									0.20~0.40	0.50~3.50	
Medium cutting VP3	VNMG 160404-VP3																										0.05~0.30	0.10~3.00
	VNMG 160408-VP3																										0.10~0.45	0.50~5.00
Medium to finishing HA	VNMG 160408-HA																										0.10~0.40	0.80~3.50

Cutting edge geometry A37~A49
 Recommended chip breaker B04~B15
 Code system B34~B35
 ● : Stock item

Available tool holders			
Designation	Page	Designation	Page
MVJNR/L	B188	MVVNN	B189
MVQNR/L	B189	MVUNR/L	B214

B Turning Insert (Negative)

WN ○ ○



Dimensions (mm)			
Size	d	t	d ₁
06	9.525	4.76	3.81
08	12.7	4.76	5.16

Trigon **80° Negative**

Workpiece	Material	Machining types													
		●	✱	●	✱	●	✱	●	✱	●	✱	●	✱	●	✱
Steel	P	●	✱	●	✱	●	✱	●	✱	●	✱	●	✱	●	✱
Stainless steel	M	●	✱	●	✱	●	✱	●	✱	●	✱	●	✱	●	✱
Cast iron	K	●	✱	●	✱	●	✱	●	✱	●	✱	●	✱	●	✱
Non-ferrous metal	N	●	✱	●	✱	●	✱	●	✱	●	✱	●	✱	●	✱
Heat resistant alloy, Titanium alloy	S	●	✱	●	✱	●	✱	●	✱	●	✱	●	✱	●	✱
Hardened steel	H	●	✱	●	✱	●	✱	●	✱	●	✱	●	✱	●	✱

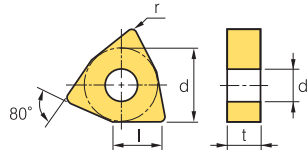
Inserts	Designation	Cermet		Coated													Uncoated		Cutting Condition									
		CN1500	CN2500	CC1500	CC2500	NC3215P	NC3225P	NC3215	NC3225	NC3120	NC3030	NC3235	NC5330	NC6310	NC6315	NC9115	NC9125	NC9135	PC8105	PC8110	PC8115	PC9030	H01	H05	f _n (mm/rev)	a _p (mm)		
Finishing		WNMG 080404-VB						●	●																0.10-0.35	0.30-1.50		
		080408-VB						●	●				●													0.15-0.45	0.50-2.00	
		080412-VB						●	●																		0.18-0.45	0.80-2.50
Finishing		WNMG 060404-VF												●												0.07-0.30	0.50-1.50	
		060408-VF																								0.10-0.40	0.50-1.50	
		080404-VF									●				●												0.07-0.30	0.50-1.50
		080408-VF													●												0.10-0.40	0.50-1.50
		080412-VF																									0.20-0.50	0.50-1.50
Finishing		WNMG 060404-VL																								0.05-0.25	0.20-1.50	
		080404-VL																								0.05-0.25	0.10-1.00	
		080408-VL									●			●													0.10-0.35	0.20-1.50
Medium to finishing		WNMG 06T308-LP																								0.07-0.30	0.30-1.50	
		060404-LP																									0.07-0.30	0.30-1.50
		060408-LP									●	●															0.10-0.30	0.30-1.50
		080404-LP									●	●			●												0.10-0.35	0.30-2.00
		080408-LP									●	●			●												0.10-0.40	0.50-2.50
		080412-LP									●	●			●												0.13-0.45	0.80-3.00
Medium to finishing		WNMG 060404-CP																								0.08-0.30	0.40-3.00	
		060408-CP																									0.10-0.30	0.40-3.00
		080404-CP								●	●																0.10-0.35	0.50-3.50
		080408-CP								●	●																0.12-0.35	0.50-3.50
		080412-CP								●	●																0.13-0.35	0.80-3.50
		080416-CP								●	●																0.14-0.35	0.80-3.50
Medium to finishing		WNMG 080404-VC								●	●															0.15-0.40	0.15-4.00	
		080408-VC								●	●															0.15-0.45	0.15-4.50	
		080412-VC								●	●			●													0.15-0.45	0.15-4.50

Cutting edge geometry **A37~A49**
 Recommended chip breaker **B04~B15**
 Code system **B34~B35**
 : Stock item

Available tool holders			
Designation	Page	Designation	Page
MWLN/L	B189	WWLN/L	B180
PWLN/L	B211		








WN



Dimensions (mm)			
Size	d	t	d ₁
06	9.525	4.76	3.81
08	12.7	4.76	5.16

Trigon **80° Negative**

Workpiece	Material											Machining types				
	Steel	Stainless steel	Cast iron	Non-ferrous metal	Heat resistant alloy, Titanium alloy	Hardened steel	P	M	K	N	S	H	Continuous cutting	General cutting	Interrupted cutting	
Steel							●	●	●	●	●	●	●	●	●	●
Stainless steel		●	●	●	●		●	●	●	●	●	●	●	●	●	●
Cast iron			●	●	●		●	●	●	●	●	●	●	●	●	●
Non-ferrous metal				●	●		●	●	●	●	●	●	●	●	●	●
Heat resistant alloy, Titanium alloy					●					●		●	●	●	●	●
Hardened steel						●						●	●	●	●	●

Inserts	Designation	Cermet		Coated		Coated											Uncoated		Cutting Condition								
		CN1500	CN2500	CC1500	CC2500	NC3215	NC3225	NC3120	NC3030	NC3235	NC5330	NC6310	NC6315	NC9115	NC9125	NC9135	PC5300	PC5400	PC8105	PC8110	PC8115	PC9030	H01	H05	f _n (mm/rev)	a _p (mm)	
	WNMG 060404-HM											●													0.15~0.43	0.42~3.00	
	060408-HM								●	●												●			0.10~0.50	1.00~4.00	
	080404-HM									●	●											●			0.15~0.42	0.50~4.20	
	080408-HM					●	●	●	●		●											●			0.10~0.50	1.00~5.00	
	080412-HM																					●			0.10~0.50	1.00~5.00	
	WNMG 06T304-MP																								0.10~0.40	0.40~2.80	
	06T308-MP																									0.15~0.45	0.50~3.00
	060404-MP							●	●			●		●												0.10~0.40	0.40~2.80
	060408-MP					●	●				●	●		●												0.15~0.45	0.50~3.00
	060412-MP																									0.15~0.50	0.80~3.20
	080404-MP					●	●			●		●	●	●		●	●	●		●	●	●				0.10~0.40	0.40~4.00
	080408-MP					●	●			●		●	●	●		●	●	●		●	●	●				0.15~0.45	0.50~4.50
	080412-MP					●	●			●		●	●	●		●	●	●		●	●	●				0.15~0.50	0.80~5.00
	080416-MP					●	●			●		●														0.18~0.55	0.10~5.00
	WNMG 060404-VM										●					●	●								0.10~0.45	1.00~3.50	
	060408-VM									●	●					●	●								0.10~0.50	1.00~4.00	
	060412-VM																								0.13~0.60	1.30~4.00	
	080404-VM									●		●				●	●								0.05~0.30	0.90~5.00	
	080408-VM					●	●	●			●					●	●	●		●	●	●				0.10~0.50	1.00~5.00
	080412-VM									●		●				●	●					●	●		0.10~0.50	1.00~5.00	
	080416-VM																									0.10~0.50	1.20~5.00
	WNMG 080404-B25					●	●			●															0.17~0.45	1.00~5.00	
	080408-B25					●	●		●		●														0.23~0.60	1.50~5.00	
	080412-B25					●	●			●															0.25~0.60	2.00~5.00	
	WNMG 080404-GR																								0.15~0.50	0.08~6.00	
	080408-GR							●	●	●		●	●												0.20~0.50	1.00~7.00	
	080412-GR					●	●	●	●		●	●													0.25~0.50	1.30~7.00	
	080416-GR																								0.25~0.60	1.80~6.00	

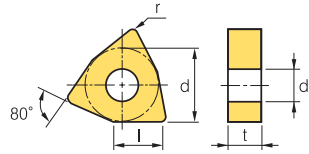
 Cutting edge geometry A37~A49
  Recommended chip breaker B04~B15
  Code system B34~B35
 ● : Stock item

Available tool holders			
Designation	Page	Designation	Page
MWLN/L	B189	WWLN/L	B180
PWLN/L	B211		



B Turning Insert (Negative)

WN



Dimensions (mm)			
Size	d	t	d ₁
06	9.525	4.76	3.81
08	12.7	4.76	5.16

Trigon **80° Negative**

Workpiece	Machining types												
	P	M	K	N	S	H	●	●	●	●	●	●	●
Steel	●	●	●	●	●	●	●	●	●	●	●	●	●
Stainless steel	●	●	●	●	●	●	●	●	●	●	●	●	●
Cast iron	●	●	●	●	●	●	●	●	●	●	●	●	●
Non-ferrous metal	●	●	●	●	●	●	●	●	●	●	●	●	●
Heat resistant alloy, Titanium alloy	●	●	●	●	●	●	●	●	●	●	●	●	●
Hardened steel	●	●	●	●	●	●	●	●	●	●	●	●	●

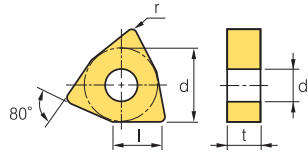
Inserts	Designation	Cermets		Coated		Coated										Uncoated		Cutting Condition										
		CN1500	CN2500	CC1500	CC2500	NC3215	NC3225	NC3120	NC3030	NC3235	NC5330	NC6310	NC6315	NC9115	NC9125	NC9135	PC5300	PC5400	PC8105	PC8110	PC8115	PC9030	H01	H05	f _n (mm/rev)	a _p (mm)		
VQ [Cermets]	WNMG 060404-VQ																									0.05-0.30	0.50-4.00	
	060408-VQ																										0.08-0.30	0.80-4.00
	060412-VQ																										0.10-0.30	1.00-4.00
	080404-VQ	●	●	●	●																						0.05-0.30	0.50-4.00
	080408-VQ	●	●	●	●																						0.08-0.40	0.80-4.00
	080412-VQ																										0.10-0.35	0.80-3.50
MK 	WNMG 060408-MK											●	●													0.08-0.30	0.80-2.50	
	080404-MK											●														0.10-0.45	1.00-3.00	
	080408-MK											●														0.10-0.50	1.00-3.50	
	080412-MK											●														0.10-0.50	1.00-4.00	
	080416-MK																										0.13-0.50	1.20-4.20
WNMA 	060404																									0.10-0.30	0.50-3.00	
	060408											●														0.10-0.30	0.50-3.00	
	060412																									0.10-0.40	1.00-3.00	
	080404											●														0.15-0.60	1.00-5.00	
	080408											●														0.15-0.60	1.00-6.00	
	080412											●														0.15-0.70	1.50-6.00	
	080416																									0.15-0.70	1.50-6.00	
RK 	WNMG 060408-RK																									0.10-0.40	1.00-3.50	
	060412-RK																									0.23-0.40	1.50-5.00	
	080404-RK											●														0.23-0.50	1.50-6.00	
	080408-RK											●	●													0.23-0.53	1.50-6.00	
	080412-RK											●	●													0.28-0.53	1.80-6.00	
	080416-RK												●													0.25-0.60	2.00-6.00	
VR 	WNMG 060408-VR																									0.20-0.40	1.00-6.00	
	080404-VR																									0.20-0.50	0.80-7.00	
	080408-VR																									0.25-0.55	1.20-7.00	
	080412-VR																									0.30-0.60	1.50-7.00	
	080416-VR																									0.40-0.60	1.50-4.00	

Cutting edge geometry **A37~A49**
 Recommended chip breaker **B04~B15**
 Code system **B34~B35**
● : Stock item

Available tool holders			
Designation	Page	Designation	Page
MWLNR/L	B189	WWLNR/L	B180
PWLNR/L	B211		



WN



Dimensions (mm)			
Size	d	t	d ₁
06	9.525	4.76	3.81
08	12.7	4.76	5.16
13	19.05	6.35	7.93

Trigon **80° Negative**

Workpiece	Material													Machining types				
	Steel	Stainless steel	Cast iron	Non-ferrous metal	Heat resistant alloy, Titanium alloy	Hardened steel	P	M	K	N	S	H						
Steel							●	●	●	●	●	●	●	●	●	●	●	●
Stainless steel							●	●	●	●	●	●	●	●	●	●	●	●
Cast iron							●	●	●	●	●	●	●	●	●	●	●	●
Non-ferrous metal							●	●	●	●	●	●	●	●	●	●	●	●
Heat resistant alloy, Titanium alloy							●	●	●	●	●	●	●	●	●	●	●	●
Hardened steel							●	●	●	●	●	●	●	●	●	●	●	●

● Continuous cutting
● General cutting
● Interrupted cutting

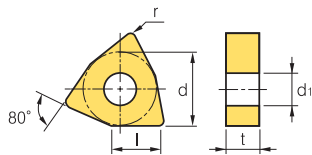
Inserts	Designation	Cermets		Coated		Coated													Uncoated		Cutting Condition						
		CN1500	CN2500	CC1500	CC2500	NC3215	NC3225	NC3120	NC3030	NC3235	NC5330	NC6315	NC9115	NC9125	NC9135	PC5300	PC5400	PC8105	PC8110	PC8115	PC8120	PC9030	H01	H05	f _n (mm/rev)	a _p (mm)	
Medium cutting 	WNMG 06T304-MM																									0.08~0.35	0.50~4.00
	WNMG 06T308-MM																									0.10~0.40	0.50~4.00
	WNMG 06T312-MM																									0.12~0.45	0.50~4.00
	WNMG 060404-MM																									0.08~0.35	0.50~4.00
	WNMG 060408-MM												●	●												0.10~0.40	0.50~4.00
	WNMG 060412-MM												●	●												0.12~0.45	0.50~4.00
	WNMG 080404-MM												●	●	●				●	●						0.10~0.40	0.50~4.00
	WNMG 080408-MM												●	●	●	●				●	●					0.12~0.45	0.50~4.00
WNMG 080412-MM												●	●	●	●				●	●					0.15~0.60	0.50~4.00	
Roughing 	WNMG 060404-RM												●	●												0.10~0.50	1.50~3.00
	WNMG 060408-RM												●	●												0.15~0.55	1.50~3.00
	WNMG 060412-RM												●	●												0.20~0.60	1.50~3.00
	WNMG 080404-RM												●	●	●				●	●						0.10~0.50	2.00~4.00
	WNMG 080408-RM												●	●	●	●				●	●					0.15~0.55	2.00~4.00
	WNMG 080412-RM												●	●	●	●				●	●					0.20~0.60	2.00~4.00
Medium to finishing 	WNMG 080404-VP2														●	●		●								0.10~0.45	0.50~5.00
	WNMG 080408-VP2								●						●	●	●	●	●				●			0.12~0.50	0.50~5.00
	WNMG 080412-VP2														●	●	●	●	●				●			0.05~0.30	0.10~3.00
Medium cutting 	WNMG 060408-VP3																									0.06~0.38	0.40~3.50
	WNMG 060412-VP3																									0.06~0.38	0.40~3.50
	WNMG 080404-VP3														●	●	●	●	●				●	●		0.10~0.45	0.50~5.00
	WNMG 080408-VP3														●	●	●	●	●				●	●		0.12~0.50	0.50~5.00
	WNMG 080412-VP3														●	●	●	●	●				●			0.05~0.30	0.10~3.00
	WNMG 130612-VP3																									0.20~0.40	1.00~5.00
Medium cutting 	WNGG 080404-VP3																									0.10~0.45	0.50~5.00
Roughing 	WNMG 080408-VP4																									0.15~0.35	1.00~4.00
	WNMG 080412-VP4																									0.20~0.40	1.00~4.00

Cutting edge geometry A37~A49 Recommended chip breaker B04~B15 Code system B34~B35 ● : Stock item

Available tool holders			
Designation	Page	Designation	Page
MWLN/L	B189	WWLN/L	B180
PWLN/L	B211		

B Turning Insert (Negative)

WN



Dimensions (mm)			
Size	d	t	d ₁
06	9.525	4.76	3.81
08	12.7	4.76	5.16
10	15.875	6.35	6.35
13	19.05	6.35	7.93

Trigon **80° Negative**

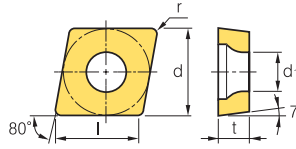
Workpiece	Machining types												
	P	M	K	N	S	H							
Steel	●	●	●	●	●	●	●	●	●	●	●	●	●
Stainless steel	●	●	●	●	●	●	●	●	●	●	●	●	●
Cast iron	●	●	●	●	●	●	●	●	●	●	●	●	●
Non-ferrous metal	●	●	●	●	●	●	●	●	●	●	●	●	●
Heat resistant alloy, Titanium alloy	●	●	●	●	●	●	●	●	●	●	●	●	●
Hardened steel	●	●	●	●	●	●	●	●	●	●	●	●	●

Inserts	Designation	Cermets		Coated		Coated										Uncoated		Cutting Condition										
		CN1500	CN2500	CC1500	CC2500	NC3215	NC3225	NC3120	NC3030	NC3235	NC5330	NC6310	NC6315	NC9115	NC9125	NC9135	PC5300	PC5400	PC8105	PC8110	PC8115	PC9030	H01	H05	f _n (mm/rev)	a _p (mm)		
Medium to finishing 	WNMG 060404-HA																									0.05-0.30	0.10-3.00	
	060408-HA																										0.10-0.40	0.80-3.50
	080404-HA																										0.05-0.30	0.80-3.50
	080408-HA																										0.10-0.40	0.80-3.50
	080412-HA																											0.13-0.55
Finishing [Wiper]	WNMG 060404-VW																										0.05-0.30	0.40-3.00
	060408-VW																										0.08-0.30	0.40-3.50
	080404-VW																										0.10-0.30	0.50-3.00
	080408-VW																										0.15-0.50	0.50-4.00
	080412-VW																										0.18-0.50	1.00-4.00
Medium cutting [Wiper]	WNMG 060408-LW					●	●							●													0.15-0.60	0.50-3.50
	060412-LW																										0.20-0.70	0.80-3.50
	080408-LW					●	●			●				●													0.15-0.60	1.00-5.00
	080412-LW					●																					0.20-0.70	1.00-6.00
Medium to finishing [Shaft]	WNMX 080404R-SR																										0.10-0.35	0.70-3.00
	080408R-SR																										0.12-0.40	1.00-3.00
	080404L-SR																										0.10-0.35	0.70-3.00
	080408L-SR																										0.12-0.40	1.00-3.00
Medium cutting [Shaft]	WNMX 080404R-SH																										0.15-0.30	1.00-4.00
	080408R-SH																										0.15-0.50	1.50-5.00
	080404L-SH																										0.15-0.30	1.00-4.00
	080408L-SH																										0.15-0.50	1.50-5.00
Medium to roughing 	WNMM 100608-B25																										0.30-0.80	3.00-8.00
	130612-B25																										0.40-0.90	4.00-10.00

Cutting edge geometry **A37~A49**
 Recommended chip breaker **B04~B15**
 Code system **B34~B35**
● : Stock item

Available tool holders			
Designation	Page	Designation	Page
MWLN/L	B189	WWLN/L	B180
PWLN/L	B211		





Dimensions (mm)			
Size	d	t	d ₁
06	6.35	2.38	2.8
09	9.525	3.97	4.4
12	12.7	4.76	5.5

Rhombic 80° Positive
Relief Angle: 7°

Workpiece	Machining types															
	P	M	K	N	S	H										
Steel	●	●	●	●	●	●	●	●	●	●	●	●	●	●	●	●
Stainless steel	●	●	●	●	●	●	●	●	●	●	●	●	●	●	●	●
Cast iron	●	●	●	●	●	●	●	●	●	●	●	●	●	●	●	●
Non-ferrous metal	●	●	●	●	●	●	●	●	●	●	●	●	●	●	●	●
Heat resistant alloy, Titanium alloy	●	●	●	●	●	●	●	●	●	●	●	●	●	●	●	●
Hardened steel	●	●	●	●	●	●	●	●	●	●	●	●	●	●	●	●

Inserts	Designation	Cermets		Coated		Coated										Uncoated		Cutting Condition										
		CN1500	CN2500	CC1500	CC2500	NC3215	NC3225	NC3120	NC3030	NC3235	NC5330	NC6310	NC6315	NC9115	NC9125	NC9135	PC5300	PC5400	PC8105	PC8110	PC8115	PC9030	H01	H05	f _n (mm/rev)	a _p (mm)		
Finishing (Mild steel)	FP [Mild steel]	CCMT 060202-FP	●																							0.01~0.10	0.05~0.08	
		CCMT 060204-FP	●	●	●	●	●	●							●							●					0.01~0.10	0.10~0.90
		CCMT 09T302-FP	●				●	●																			0.01~0.10	0.05~1.00
		CCMT 09T304-FP	●	●	●	●	●	●							●								●				0.01~0.10	0.10~1.00
		CCMT 09T308-FP	●	●	●	●	●	●							●								●				0.04~0.12	0.10~1.00
Finishing		CCMT 060202-VF					●									●					●					0.05~0.20	0.30~1.00	
		CCMT 060204-VF	●	●			●									●						●				0.10~0.25	0.30~1.00	
		CCMT 09T302-VF					●																			0.04~0.16	0.80~1.50	
		CCMT 09T304-VF	●	●			●									●						●				0.05~0.20	0.30~1.50	
		CCMT 09T308-VF		●			●									●											0.10~0.25	0.30~1.50
		CCMT 120404-VF					●																				0.07~0.22	0.10~2.00
Finishing		CCMT 060202-VL																								0.04~0.18	0.20~1.40	
		CCMT 060204-VL	●	●	●	●	●	●					●		●	●	●	●	●	●	●	●	●	●	●	●	0.04~0.10	0.08~0.90
		CCMT 060208-VL					●	●					●		●	●											0.06~0.12	0.10~1.00
		CCMT 09T304-VL	●	●	●	●	●	●					●		●	●	●	●	●	●	●	●	●	●	●	●	0.05~0.10	0.10~1.00
		CCMT 09T308-VL	●	●	●	●	●	●					●		●	●	●	●	●	●	●	●	●	●	●	●	0.08~0.15	0.10~1.00
		CCMT 120404-VL																									0.06~0.12	0.30~1.50
		CCMT 120408-VL																									0.08~0.15	0.30~1.50
CCMT 120412-VL																									0.08~0.15	0.30~1.50		
Medium to finishing		CCMT 060202-HMP	●													●					●	●				0.03~0.12	0.10~1.50	
		CCMT 060204-HMP		●							●	●			●		●					●	●				0.06~0.17	0.20~2.40
		CCMT 060208-HMP									●	●			●		●					●	●				0.08~0.23	0.40~2.40
		CCMT 09T302-HMP																					●	●			0.07~0.22	0.10~2.00
		CCMT 09T304-HMP		●							●	●			●		●						●	●			0.08~0.23	0.30~3.00
		CCMT 09T308-HMP		●							●	●			●		●						●	●			0.10~0.30	0.50~3.00
		CCMT 120404-HMP									●	●			●		●						●	●			0.09~0.27	0.30~3.60
		CCMT 120408-HMP									●	●			●		●						●	●			0.24~0.36	1.00~3.60
CCMT 120412-HMP																						●			0.14~0.43	0.70~3.60		
Medium to finishing		CCMT 060202-MP	●	●	●	●	●	●					●		●	●	●	●	●	●	●	●	●	●	●	0.04~0.12	0.20~1.50	
		CCMT 060204-MP	●	●	●	●	●	●					●		●	●	●	●	●	●	●	●	●	●	●	0.05~0.15	0.30~1.50	
		CCMT 060208-MP														●										0.07~0.15	0.50~2.00	
		CCMT 09T302-MP	●	●	●	●	●	●							●		●	●	●	●	●	●	●	●	●	●	0.07~0.15	0.30~2.00
		CCMT 09T304-MP	●	●	●	●	●	●							●		●	●	●	●	●	●	●	●	●	●	0.08~0.25	0.50~2.50
		CCMT 09T308-MP	●	●	●	●	●	●							●		●	●	●	●	●	●	●	●	●	●	0.10~0.30	0.50~2.50
		CCMT 120404-MP														●		●	●							0.10~0.30	0.50~3.50	
		CCMT 120408-MP														●		●	●								0.15~0.35	0.80~3.50
CCMT 120412-MP																						●	●		0.25~0.40	1.00~3.50		

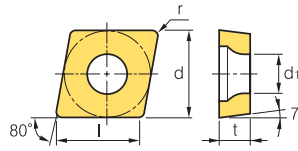
Cutting edge geometry A37~A49
 Recommended chip breaker B04~B15
 Code system B34~B35
 ● : Stock item

Available tool holders			
Designation	Page	Designation	Page
SCACR/L	B123, 190	SCLCR/L	B123, 190, 215, 225

B Turning Insert (Positive)

CC ○ ○

Rhombic 80° Positive
Relief Angle: 7°



Dimensions (mm)			
Size	d	t	d ₁
06	6.35	2.38	2.8
09	9.525	3.97	4.4
12	12.7	4.76	5.5

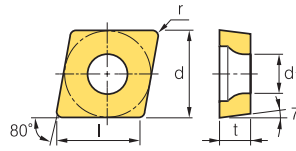
Workpiece	Material													Machining types			
	Steel	Stainless steel	Cast iron	Non-ferrous metal	Heat resistant alloy, Titanium alloy	Hardened steel	P	M	K	N	S	H	●	⊕	⊛	⊚	
Steel							●	⊕	●	⊕	●	⊕	●	⊕	●	⊕	●
Stainless steel							●	⊕	●	⊕	●	⊕	●	⊕	●	⊕	●
Cast iron							●	⊕	●	⊕	●	⊕	●	⊕	●	⊕	●
Non-ferrous metal													●	⊕	●	⊕	●
Heat resistant alloy, Titanium alloy													●	⊕	●	⊕	●
Hardened steel													●	⊕	●	⊕	●

Inserts	Designation	Cermet		Coated		Coated										Uncoated		Cutting Condition													
		CN1500	CN2500	CC1500	CC2500	NC3215	NC3225	NC3120	NC3030	NC3235	NC5330	NC6310	NC6315	NC9115	NC9125	NC9135	PC5300	PC5400	PC8105	PC8110	PC8115	PC9030	H01	H05	f _n (mm/rev)	a _p (mm)					
Medium cutting	C25 	CCMT	060202-C25	●	●	●	●	●	●	●	●	●	●	●	●	●	●	●	●	●	●	●	●	●	●	0.03~0.12	0.40~2.00				
			060204-C25	●	●	●	●	●	●	●	●	●	●	●	●	●	●	●	●	●	●	●	●	●	●	●	0.05~0.15	0.60~2.30			
			060208-C25	●	●	●	●	●	●	●	●	●	●	●	●	●	●	●	●	●	●	●	●	●	●	●	●	0.07~0.20	0.80~2.30		
			09T302-C25																									0.05~0.20	0.50~2.50		
			09T304-C25	●	●	●	●	●	●	●	●	●	●	●	●	●	●	●	●	●	●	●	●	●	●	●	●	●	0.08~0.25	0.80~3.00	
			09T308-C25	●	●	●	●	●	●	●	●	●	●	●	●	●	●	●	●	●	●	●	●	●	●	●	●	●	0.10~0.30	1.00~3.00	
			120404-C25					●	●	●	●	●	●	●	●	●	●	●	●	●	●	●	●	●	●	●	●	●	0.10~0.32	0.80~3.00	
			120408-C25	●	●	●	●	●	●	●	●	●	●	●	●	●	●	●	●	●	●	●	●	●	●	●	●	●	0.12~0.36	1.20~3.50	
			120412-C25					●	●				●	●														●	0.15~0.40	1.40~3.50	
Finishing	VP1 	CCMT	060204-VP1																								0.06~0.12	0.10~1.50			
			09T304-VP1																									0.06~0.20	0.10~1.50		
			09T308-VP1																										0.08~0.20	0.50~2.00	
			120404-VP1																										0.08~0.22	0.20~2.00	
			120408-VP1																										0.10~0.25	0.50~2.00	
Finishing	FS 	CCGT	060201-FS														●			●							0.01~0.18	0.03~1.60			
			060202-FS															●			●							0.02~0.20	0.04~1.70		
			060204-FS																●			●							0.04~0.21	0.06~1.80	
			09T301-FS																●			●							0.01~0.20	0.04~1.80	
			09T302-FS																●			●							0.02~0.23	0.05~2.00	
			09T304-FS																●			●							0.04~0.23	0.08~2.00	
Finishing	FS 	CCGT	060201MFN-FS																									0.01~0.18	0.03~1.60		
			060202MFN-FS																										0.02~0.20	0.04~1.70	
			060204MFN-FS																											0.04~0.21	0.06~1.80
			09T301MFN-FS																											0.01~0.20	0.04~1.80
			09T302MFN-FS																											0.02~0.23	0.05~2.00
			09T304MFN-FS																											0.04~0.23	0.08~2.00
Medium cutting	MS 	CCGT	09T301-MS														●			●								0.02~0.23	0.05~2.00		
			09T302-MS															●			●								0.03~0.25	0.07~2.50	
			09T304-MS																●			●								0.05~0.25	0.09~2.50
Medium cutting	MS 	CCGT	09T301MFN-MS														●			●								0.02~0.23	0.05~2.00		
			09T302MFN-MS															●			●								0.03~0.25	0.07~2.50	
			09T304MFN-MS																●			●								0.05~0.25	0.09~2.50

➤ Cutting edge geometry A37~A49 ➤ Recommended chip breaker B04~B15 ➤ Code system B34~B35 ● : Stock item

Available tool holders			
Designation	Page	Designation	Page
SCACR/L	B123, 190	SCLCR/L	B123, 190, 215, 225





Dimensions (mm)			
Size	d	t	d ₁
*03	3.5	1.39	1.9
*04	4.3	1.79	2.3
06	6.35	2.38	2.8
09	9.525	3.97	4.4

Rhombic 80° Positive Relief Angle: 7°

*: The d and t are special dimensions.

Workpiece	Machining types															
	P	M	K	N	S	H										
Steel	●	●	●	●	●	●	●	●	●	●	●	●	●	●	●	●
Stainless steel	●	●	●	●	●	●	●	●	●	●	●	●	●	●	●	●
Cast iron	●	●	●	●	●	●	●	●	●	●	●	●	●	●	●	●
Non-ferrous metal	●	●	●	●	●	●	●	●	●	●	●	●	●	●	●	●
Heat resistant alloy, Titanium alloy	●	●	●	●	●	●	●	●	●	●	●	●	●	●	●	●
Hardened steel	●	●	●	●	●	●	●	●	●	●	●	●	●	●	●	●

Inserts	Designation	Cermert		Coated		Coated										Uncoated		Cutting Condition										
		CN1500	CN2500	CC1500	CC2500	NC3215	NC3225	NC3120	NC3030	NC3235	NC5330	NC6310	NC6315	NC9115	NC9125	NC9135	PC5300	PC5400	PC8105	PC8110	PC8115	PC9030	H01	H05	f _n (mm/rev)	a _p (mm)		
Finishing [High precision]	CCGT	060201-VP1														●	●	●	●	●	●	●			0.05~0.06	0.06~1.00		
		060202-VP1															●	●	●	●	●	●	●			0.03~0.10	0.08~1.50	
		060204-VP1															●	●	●	●	●	●	●			0.05~0.12	0.10~1.50	
		09T301-VP1															●	●	●	●	●	●	●			0.03~0.13	0.06~1.00	
		09T302-VP1															●	●	●	●	●	●	●			0.04~0.15	0.08~1.50	
		09T304-VP1															●	●	●	●	●	●	●			0.06~0.20	0.10~1.50	
Finishing [Ultra high precision]	CCGT	060201MFN-VP1														●	●	●	●	●	●	●			0.03~0.06	0.06~1.00		
		060202MFN-VP1															●	●	●	●	●	●	●			0.03~0.10	0.08~1.50	
		060204MFN-VP1															●	●	●	●	●	●	●			0.05~0.12	0.10~1.50	
		09T301MFN-VP1															●	●	●	●	●	●	●			0.03~0.13	0.06~1.00	
		09T302MFN-VP1															●	●	●	●	●	●	●			0.04~0.15	0.08~1.50	
		09T304MFN-VP1															●	●	●	●	●	●	●			0.06~0.20	0.10~1.50	
Finishing *	CCET	0301005R																								0.01~0.05	0.10~0.30	
		030101R																									0.01~0.05	0.10~0.30
		030102R																									0.01~0.05	0.10~0.30
		030104R																									0.01~0.05	0.10~0.30
		0401005R																									0.01~0.10	0.10~0.50
		040101R																									0.01~0.10	0.10~0.50
		040102R																									0.01~0.10	0.10~0.50
		040104R																									0.01~0.10	0.10~0.50
		0301005L																									0.01~0.05	0.10~0.30
		030101L																									0.01~0.05	0.10~0.30
		030102L																						●	●		0.01~0.05	0.10~0.30
		030104L																									0.01~0.05	0.10~0.30
		0401005L																									0.01~0.10	0.10~0.50
		040101L																									0.01~0.10	0.10~0.50
040102L																						●	●		0.01~0.10	0.10~0.50		
040104L																						●	●		0.01~0.10	0.10~0.50		

Cutting edge geometry A37~A49
 Recommended chip breaker B04~B15
 Code system B34~B35
 ●: Stock item

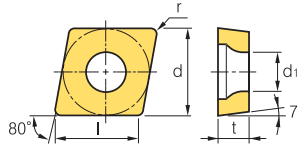
Available tool holders			
Designation	Page	Designation	Page
SCACR/L	B123, 190	SCLCR/L	B123, 190, 215, 225

B Turning Insert (Positive)

CC ○ ○



Rhombic 80° Positive
Relief Angle: 7°



Dimensions (mm)			
Size	d	t	d ₁
*03	3.5	1.39	1.9
*04	4.3	1.79	2.3
06	6.35	2.38	2.8
09	9.525	3.97	4.4

*: The d and t are special dimensions.

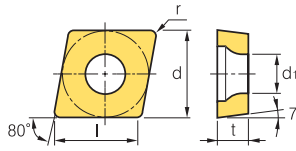
Workpiece	Machining types											
	P	M	K	N	S	H						
Steel	●	●	●	●	●	●	●	●	●	●	●	●
Stainless steel	●	●	●	●	●	●	●	●	●	●	●	●
Cast iron	●	●	●	●	●	●	●	●	●	●	●	●
Non-ferrous metal	●	●	●	●	●	●	●	●	●	●	●	●
Heat resistant alloy, Titanium alloy	●	●	●	●	●	●	●	●	●	●	●	●
Hardened steel	●	●	●	●	●	●	●	●	●	●	●	●

Inserts	Designation	Cermert		Coated		Coated										Uncoated		Cutting Condition											
		CN1500	CN2500	CC1500	CC2500	NC3215	NC3225	NC3120	NC3030	NC3235	NC5330	NC6310	NC6315	NC9115	NC9125	NC9135	PC5300	PC5400	PC8105	PC8110	PC8115	PC9030	H01	H05	f _n (mm/rev)	a _p (mm)			
Finishing [High precision]	* CCGT															●			●							0.01-0.05	0.10-0.30		
	030101R-KF															●			●								0.01-0.05	0.10-0.30	
	030102R-KF															●			●								0.01-0.05	0.10-0.30	
	030104R-KF															●			●								0.01-0.05	0.10-0.30	
	0401003R-KF															●			●								0.01-0.10	0.10-0.50	
	040101R-KF															●			●								0.01-0.10	0.10-0.50	
	040102R-KF															●			●								0.01-0.10	0.10-0.50	
	040104R-KF															●			●								0.01-0.10	0.10-0.50	
	0602003R-KF																											0.01-0.06	0.04-1.30
	060201R-KF																											0.02-0.08	0.05-1.50
	060202R-KF																											0.03-0.11	0.06-1.70
	09T3003R-KF																											0.02-0.08	0.05-1.50
	09T301R-KF																											0.03-0.11	0.06-1.70
	09T302R-KF																											0.04-0.15	0.08-2.00
	0301003L-KF																●			●								0.01-0.05	0.10-0.30
	030101L-KF																●			●								0.01-0.05	0.10-0.30
	030102L-KF																●			●								0.01-0.05	0.10-0.30
	030104L-KF																●			●								0.01-0.05	0.10-0.30
	0401003L-KF																●			●								0.01-0.10	0.10-0.50
	040101L-KF																●			●								0.01-0.10	0.10-0.50
	040102L-KF																●			●								0.01-0.10	0.10-0.50
	040104L-KF																●			●								0.01-0.10	0.10-0.50
	0602003L-KF																											0.01-0.06	0.04-1.30
	060201L-KF																											0.02-0.08	0.05-1.50
	060202L-KF																											0.03-0.11	0.06-1.70
	09T3003L-KF																											0.02-0.08	0.05-1.50
09T301L-KF																											0.03-0.11	0.06-1.70	
09T302L-KF																											0.04-0.15	0.08-2.00	
Finishing [Ultra high precision]	CCET															●			●								0.01-0.06	0.04-1.30	
	060201MFR-KF															●			●									0.02-0.08	0.05-1.50
	060202MFR-KF															●			●									0.03-0.11	0.06-1.70
	09T3005MFR-KF															●			●									0.02-0.08	0.05-1.50
	09T301MFR-KF															●			●									0.03-0.11	0.06-1.70
	09T302MFR-KF															●			●									0.04-0.15	0.08-2.00
	0602005MFL-KF															●			●									0.01-0.06	0.04-1.30
	060201MFL-KF															●			●									0.02-0.08	0.05-1.50
	060202MFL-KF															●			●									0.03-0.11	0.06-1.70
	09T3005MFL-KF															●			●									0.02-0.08	0.05-1.50
	09T301MFL-KF															●			●									0.03-0.11	0.06-1.70
	09T302MFL-KF															●			●									0.04-0.15	0.08-2.00

⌚ Cutting edge geometry A37~A49 ⌚ Recommended chip breaker B04~B15 ⌚ Code system B34~B35 ● : Stock item

Available tool holders			
Designation	Page	Designation	Page
SCACR/L	B123, 190	SCLCR/L	B123, 190, 215, 225





Dimensions (mm)			
Size	d	t	d ₁
06	6.35	2.38	2.8
09	9.525	3.97	4.4

Rhombic 80° Positive
Relief Angle: 7°

Workpiece	Material												Machining types		
	Steel	Stainless steel	Cast iron	Non-ferrous metal	Heat resistant alloy, Titanium alloy	Hardened steel	P	M	K	N	S	H	Continuous cutting	General cutting	Interrupted cutting
Steel	●	●	●	●	●	●	●	●	●	●	●	●	●	●	●
Stainless steel	●	●	●	●	●	●	●	●	●	●	●	●	●	●	●
Cast iron	●	●	●	●	●	●	●	●	●	●	●	●	●	●	●
Non-ferrous metal	●	●	●	●	●	●	●	●	●	●	●	●	●	●	●
Heat resistant alloy, Titanium alloy	●	●	●	●	●	●	●	●	●	●	●	●	●	●	●
Hardened steel	●	●	●	●	●	●	●	●	●	●	●	●	●	●	●

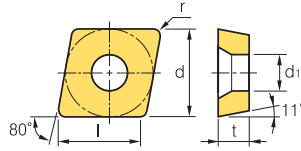
Inserts	Designation	Cermet		Coated		Coated										Uncoated		Cutting Condition										
		CN1500	CN2500	CC1500	CC2500	NC3215	NC3225	NC3120	NC3030	NC3235	NC5330	NC6310	NC6315	NC9115	NC9125	NC9135	PC5300	PC5400	PC8105	PC8110	PC8115	PC9030	H01	H05	f _n (mm/rev)	a _p (mm)		
Medium to finishing KM [High precision]	CCGT 0602003R-KM															●										0.01~0.06	0.04~1.30	
	060201R-KM															●											0.02~0.08	0.05~1.50
	060202R-KM															●							●			0.03~0.11	0.06~1.70	
	060204R-KM															●										0.04~0.13	0.04~1.70	
	09T3003R-KM															●										0.02~0.08	0.06~1.50	
	09T301R-KM															●										0.03~0.11	0.06~1.70	
	09T302R-KM															●										0.04~0.15	0.08~2.00	
	09T304R-KM															●										0.05~0.16	0.10~2.00	
	0602003L-KM																●										0.01~0.06	0.04~1.30
	060201L-KM																●										0.02~0.08	0.05~1.50
	060202L-KM																●										0.03~0.11	0.06~1.70
	060204L-KM																●										0.04~0.13	0.04~1.70
	09T3003L-KM																●										0.02~0.08	0.06~1.50
	09T301L-KM																●										0.03~0.11	0.06~1.70
	09T302L-KM																●										0.04~0.15	0.08~2.00
09T304L-KM																●										0.05~0.16	0.10~2.00	
Medium to finishing KM [Ultra high precision]	CCET 0602005MFR-KM															●										0.01~0.06	0.04~1.30	
	060201MFR-KM															●											0.02~0.08	0.05~1.50
	060202MFR-KM															●											0.03~0.11	0.06~1.70
	09T3005MFR-KM																●										0.02~0.08	0.05~1.50
	09T301MFR-KM																●										0.03~0.11	0.06~1.70
	09T302MFR-KM																●										0.04~0.15	0.08~2.00
	0602005MFL-KM																●										0.01~0.06	0.04~1.30
	060201MFL-KM																●										0.02~0.08	0.05~1.50
	060202MFL-KM																●										0.03~0.11	0.06~1.70
	09T3005MFL-KM																	●									0.02~0.08	0.05~1.50
	09T301MFL-KM																	●									0.03~0.11	0.06~1.70
	09T302MFL-KM																	●									0.04~0.15	0.08~2.00

➔ Cutting edge geometry **A37~A49**
 ➔ Recommended chip breaker **B04~B15**
 ➔ Code system **B34~B35**
 ●: Stock item

Available tool holders			
Designation	Page	Designation	Page
SCACR/L	B123, 190	SCLCR/L	B123, 190, 215, 225

B Turning Insert (Positive)

CP



Dimensions (mm)			
Size	d	t	d ₁
06	6.35	2.38	2.8
08	7.94	2.38	3.4
09	9.525	3.18	4.4

Rhombic **80° Positive**
Relief Angle: 11°

Workpiece	Machining types																								
	P	M	K	N	S	H	NC3215	NC3225	NC3120	NC3030	NC3235	NC5330	NC6310	NC6315	NC9115	NC9125	NC9135	PC5300	PC5400	PC8105	PC8110	PC8115	PC9030	H01	H05
Steel	●	●	●	●	●	●	●	●	●	●	●	●	●	●	●	●	●	●	●	●	●	●	●	●	●
Stainless steel	●	●	●	●	●	●	●	●	●	●	●	●	●	●	●	●	●	●	●	●	●	●	●	●	●
Cast iron	●	●	●	●	●	●	●	●	●	●	●	●	●	●	●	●	●	●	●	●	●	●	●	●	●
Non-ferrous metal	●	●	●	●	●	●	●	●	●	●	●	●	●	●	●	●	●	●	●	●	●	●	●	●	●
Heat resistant alloy, Titanium alloy	●	●	●	●	●	●	●	●	●	●	●	●	●	●	●	●	●	●	●	●	●	●	●	●	●
Hardened steel	●	●	●	●	●	●	●	●	●	●	●	●	●	●	●	●	●	●	●	●	●	●	●	●	●

Inserts	Designation	Cermet		Coated		Coated													Uncoated		Cutting Condition								
		CN1500	CN2500	CC1500	CC2500	NC3215	NC3225	NC3120	NC3030	NC3235	NC5330	NC6310	NC6315	NC9115	NC9125	NC9135	PC5300	PC5400	PC8105	PC8110	PC8115	PC9030	H01	H05	f _n (mm/rev)	a _p (mm)			
Finishing		CPMT 080204-VF																								0.05-0.20	0.30-1.20		
		080208-VF																									0.10-0.25	0.30-1.20	
		090304-VF									●																0.05-0.20	0.30-1.50	
		090308-VF									●																	0.10-0.25	0.30-1.50
Finishing		CPMT 080204-VL																									0.03-0.08	0.08-1.00	
		080208-VL																										0.04-0.12	0.10-1.00
		090304-VL																										0.05-0.10	0.10-1.00
		090308-VL																										0.08-0.15	0.10-1.00
Medium to finishing		CPGT 090308-HMP																									0.05-0.20	0.70-2.00	
Medium cutting		CPMT 060204-C25																									0.05-0.15	0.60-2.30	
Finishing		CPGT 080202																									0.06-0.20	0.10-2.00	
		080204	●																								0.08-0.20	0.30-2.00	
		080208																										0.10-0.25	0.50-2.00
		090302																										0.04-0.20	0.30-1.50
		090304	●																									0.06-0.25	0.50-2.00
		090308																										0.08-0.30	0.70-2.50

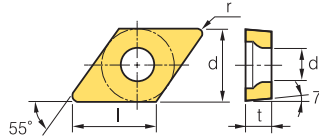
Cutting edge geometry **A37~A49**
 Recommended chip breaker **B04~B15**
 Code system **B34~B35**
● : Stock item

Available tool holders	
Designation	Page
SCLPR/L	B216



DC ○ ○ ○

Rhombic 55° Positive
Relief Angle: 7°



Dimensions (mm)			
Size	d	t	d ₁
07	6.35	2.38	2.8
11	9.525	3.97	4.4

Workpiece	Machining types															
	P	M	K	N	S	H										
Steel	●	●	●	●	●	●	●	●	●	●	●	●	●	●	●	●
Stainless steel	●	●	●	●	●	●	●	●	●	●	●	●	●	●	●	●
Cast iron	●	●	●	●	●	●	●	●	●	●	●	●	●	●	●	●
Non-ferrous metal	●	●	●	●	●	●	●	●	●	●	●	●	●	●	●	●
Heat resistant alloy, Titanium alloy	●	●	●	●	●	●	●	●	●	●	●	●	●	●	●	●
Hardened steel	●	●	●	●	●	●	●	●	●	●	●	●	●	●	●	●

● Continuous cutting
● General cutting
● Interrupted cutting

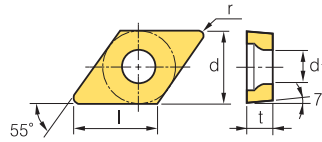
Inserts	Designation	Cermert		Coated		Coated												Uncoated		Cutting Condition						
		CN1500	CN2500	CC1500	CC2500	NC3215	NC3225	NC3120	NC3030	NC3235	NC5330	NC6310	NC6315	NC9115	NC9125	NC9135	PC5300	PC5400	PC8105	PC8110	PC8115	PC9030	H01	H05	f _n (mm/rev)	a _p (mm)
Finishing FP <small>[Mild steel]</small>	DCMT 070202-FP	●				●																			0.01~0.10	0.05~0.08
	DCMT 070204-FP	●	●	●	●	●	●							●						●					0.01~0.10	0.10~0.90
	DCMT 070208-FP																								0.01~0.10	0.10~1.00
	DCMT 11T302-FP					●																			0.01~0.10	0.05~1.00
	DCMT 11T304-FP	●	●	●	●	●	●							●							●				0.01~0.10	0.10~1.00
	DCMT 11T308-FP	●	●	●	●	●	●							●							●				0.04~0.12	0.10~1.00
Finishing VF	DCMT 070202-VF									●														0.03~0.10	0.06~1.00	
	DCMT 070204-VF									●											●			0.05~0.20	0.30~1.20	
	DCMT 11T302-VF	●								●														0.04~0.15	0.08~1.50	
	DCMT 11T304-VF	●	●							●											●			0.05~0.20	0.30~1.50	
	DCMT 11T308-VF	●	●							●											●			0.10~0.25	0.30~1.50	
Finishing VL	DCMT 070202-VL																							0.02~0.10	0.06~0.80	
	DCMT 070204-VL	●	●	●	●	●	●				●			●	●	●	●	●	●	●	●	●	●	0.04~0.10	0.08~0.90	
	DCMT 070208-VL					●	●																	0.06~0.12	0.10~1.00	
	DCMT 11T302-VL																							0.03~0.10	0.07~0.80	
	DCMT 11T304-VL	●	●	●	●	●	●				●			●	●	●	●	●	●	●	●	●	●	0.05~0.10	0.10~1.00	
	DCMT 11T308-VL	●	●	●	●	●	●				●			●	●	●	●	●	●	●	●	●	●	0.08~0.15	0.10~1.00	
	DCMT 11T312-VL																							0.08~0.15	0.30~1.50	
Medium to finishing HMP	DCMT 070202-HMP									●												●	0.03~0.12	0.10~1.50		
	DCMT 070204-HMP									●	●						●				●	●	0.06~0.17	0.20~2.30		
	DCMT 070208-HMP									●	●										●	●	0.08~0.23	0.40~2.30		
	DCMT 11T302-HMP									●											●	●	0.04~0.22	0.10~2.00		
	DCMT 11T304-HMP	●								●	●										●	●	0.08~0.23	0.30~3.00		
	DCMT 11T308-HMP									●	●										●	●	0.10~0.30	0.50~3.00		
Medium to finishing MP	DCMT 070202-MP	●	●	●	●	●	●				●			●	●	●	●	●	●	●	●	●	0.04~0.12	0.12~1.80		
	DCMT 070204-MP	●	●	●	●	●	●				●			●	●	●	●	●	●	●	●	●	0.05~0.15	0.30~1.80		
	DCMT 070208-MP	●	●	●	●	●	●				●			●	●	●	●	●	●	●	●	●	0.08~0.22	0.30~1.80		
	DCMT 11T302-MP	●	●	●	●	●	●				●			●	●	●	●	●	●	●	●	●	0.04~0.15	0.30~2.00		
	DCMT 11T304-MP	●	●	●	●	●	●				●	●		●	●	●	●	●	●	●	●	●	0.08~0.20	0.50~2.30		
	DCMT 11T308-MP	●	●	●	●	●	●				●	●		●	●	●	●	●	●	●	●	●	0.10~0.30	0.50~2.30		
	DCMT 11T312-MP														●	●							0.25~0.35	0.80~3.00		

Cutting edge geometry **A37~A49**
 Recommended chip breaker **B04~B15**
 Code system **B34~B35**
● : Stock item

Available tool holders			
Designation	Page	Designation	Page
SDACR/L	B190	SDQCR/L	B217
SDJCR/L	B123, 191	SDUCR/L	B218
SDNCN	B124, 191	SDZCR/L	B219

B Turning Insert (Positive)

DC



Dimensions (mm)			
Size	d	t	d ₁
07	6.35	2.38	2.8
11	9.525	3.97	4.4

Rhombic 55° Positive
Relief Angle: 7°

Workpiece	Machining types											
	P	M	K	N	S	H						
Steel	●	●	●	●	●	●	●	●	●	●	●	●
Stainless steel	●	●	●	●	●	●	●	●	●	●	●	●
Cast iron	●	●	●	●	●	●	●	●	●	●	●	●
Non-ferrous metal	●	●	●	●	●	●	●	●	●	●	●	●
Heat resistant alloy, Titanium alloy	●	●	●	●	●	●	●	●	●	●	●	●
Hardened steel	●	●	●	●	●	●	●	●	●	●	●	●

Inserts	Designation	Cermet		Coated										Uncoated		Cutting Condition										
		CN1500	CN2500	CC1500	CC2500	NC3215	NC3225	NC3120	NC3030	NC3235	NC5330	NC6310	NC6315	NC9115	NC9125	NC9135	PC5300	PC5400	PC8105	PC8110	PC8115	PC9030	H01	H05	f _n (mm/rev)	a _p (mm)
Medium cutting C25	DCMT 070202-C25	●	●	●	●	●	●	●	●	●	●	●	●	●	●	●	●	●	●	●	●	●	●	●	0.03-0.15	0.30-2.00
	070204-C25	●	●	●	●	●	●	●	●	●	●	●	●	●	●	●	●	●	●	●	●	●	●	●	0.05-0.20	0.50-2.50
	070208-C25	●	●	●	●	●	●	●	●	●	●	●	●	●	●	●	●	●	●	●	●	●	●	●	0.06-0.25	0.80-2.50
	11T302-C25	●	●	●	●	●	●	●	●	●	●	●	●	●	●	●	●	●	●	●	●	●	●	●	0.04-0.25	0.50-2.50
	11T304-C25	●	●	●	●	●	●	●	●	●	●	●	●	●	●	●	●	●	●	●	●	●	●	●	0.08-0.30	0.80-3.00
	11T308-C25	●	●	●	●	●	●	●	●	●	●	●	●	●	●	●	●	●	●	●	●	●	●	●	0.10-0.30	1.00-3.00
Finishing VP1	DCMT 070204-VP1																								0.05-0.12	0.10-1.50
	11T304-VP1																								0.06-0.20	0.10-1.50
	11T308-VP1																								0.08-0.23	0.10-1.50
Finishing FS [High precision]	DCGT 070201-FS															●			●						0.01-0.18	0.03-1.60
	070202-FS															●			●						0.02-0.20	0.04-1.70
	11T301-FS															●			●						0.01-0.20	0.04-1.80
	11T302-FS															●			●						0.02-0.23	0.05-2.00
	11T304-FS															●			●						0.04-0.23	0.08-2.00
	11T308-FS															●			●						0.06-0.25	0.10-2.20
Finishing FS [Ultra high precision]	DCGT 070201MFN-FS																								0.01-0.18	0.03-1.60
	070202MFN-FS																								0.02-0.20	0.04-1.70
	11T301MFN-FS																								0.01-0.20	0.04-1.80
	11T302MFN-FS																								0.02-0.23	0.05-2.00
	11T304MFN-FS																								0.04-0.23	0.08-2.00
	11T308MFN-FS																								0.06-0.25	0.10-2.20
Medium cutting MS [High precision]	DCGT 11T301-MS															●			●						0.02-0.23	0.05-2.00
	11T302-MS															●			●						0.03-0.25	0.07-2.50
	11T304-MS															●			●						0.05-0.25	0.09-2.50
Medium cutting MS [Ultra high precision]	DCGT 11T301MFN-MS															●			●						0.02-0.23	0.05-2.00
	11T302MFN-MS															●			●						0.03-0.25	0.07-2.50
	11T304MFN-MS															●			●						0.05-0.25	0.09-2.50

🔄 Cutting edge geometry A37~A49
 🔄 Recommended chip breaker B04~B15
 🔄 Code system B34~B35
 ● : Stock item

Available tool holders			
Designation	Page	Designation	Page
SDACR/L	B190	SDQCR/L	B217
SDJCR/L	B123, 191	SDUCR/L	B218
SDNCN	B124, 191	SDZCR/L	B219

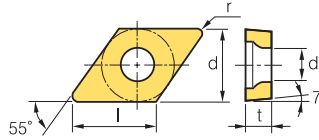


DC



Rhombic 55° Positive

Relief Angle: 7°



Dimensions (mm)			
Size	d	t	d ₁
07	6.35	2.38	2.8
11	9.525	3.97	4.4

Workpiece	Machining types															
	P	M	K	N	S	H	●	●	●	●	●	●	●	●	●	●
Steel	●	●	●	●	●	●	●	●	●	●	●	●	●	●	●	●
Stainless steel	●	●	●	●	●	●	●	●	●	●	●	●	●	●	●	●
Cast iron	●	●	●	●	●	●	●	●	●	●	●	●	●	●	●	●
Non-ferrous metal	●	●	●	●	●	●	●	●	●	●	●	●	●	●	●	●
Heat resistant alloy, Titanium alloy	●	●	●	●	●	●	●	●	●	●	●	●	●	●	●	●
Hardened steel	●	●	●	●	●	●	●	●	●	●	●	●	●	●	●	●

Inserts	Designation	Cermet		Coated		Coated										Uncoated		Cutting Condition										
		CN1500	CN2500	CC1500	CC2500	NC3215	NC3225	NC3120	NC3030	NC3235	NC5330	NC6310	NC6315	NC9115	NC9125	NC9135	PC5300	PC5400	PC8105	PC8110	PC8115	PC9030	H01	H05	f _n (mm/rev)	a _p (mm)		
Finishing VP1 [High precision]	DCGT 070201-VP1															●		●	●	●		●			0.03~0.06	0.06~1.00		
	070202-VP1															●		●	●	●		●			0.03~0.10	0.08~1.50		
	070204-VP1															●		●	●	●		●			0.05~0.12	0.10~1.50		
	11T301-VP1															●			●				●			0.03~0.13	0.06~1.00	
	11T302-VP1															●		●	●	●		●				0.04~0.15	0.08~1.50	
	11T304-VP1															●		●	●	●		●				0.06~0.20	0.10~1.50	
Finishing VP1 [Ultra high precision]	DCGT 070201MFN-VP1															●			●							0.03~0.06	0.06~1.00	
	070202MFN-VP1															●			●							0.03~0.10	0.08~1.50	
	070204MFN-VP1															●			●							0.05~0.12	0.10~1.50	
	11T301MFN-VP1															●			●							0.03~0.13	0.06~1.00	
	11T302MFN-VP1															●		●	●	●		●				0.04~0.15	0.08~1.50	
	11T304MFN-VP1															●		●	●	●		●				0.06~0.20	0.10~1.50	
Finishing KF [High precision]	DCGT 0702003R-KF															●			●							0.01~0.06	0.04~1.30	
	070201R-KF															●			●							0.02~0.08	0.05~1.50	
	070202R-KF															●			●							0.03~0.11	0.06~1.50	
	070204R-KF															●			●							0.04~0.13	0.04~1.70	
	11T3003R-KF															●			●							0.02~0.08	0.05~1.50	
	11T301R-KF															●			●							0.03~0.11	0.06~1.70	
	11T302R-KF															●		●	●		●		●			0.04~0.15	0.08~2.00	
	11T304R-KF															●		●	●		●					0.05~0.16	0.10~2.00	
	0702003L-KF																●			●							0.01~0.06	0.04~1.30
	070201L-KF																●			●							0.02~0.08	0.05~1.50
	070202L-KF																●			●							0.03~0.11	0.06~1.50
	070204L-KF																●			●							0.04~0.13	0.04~1.70
	11T3003L-KF																●			●							0.02~0.08	0.05~1.50
	11T301L-KF																●			●							0.03~0.11	0.06~1.70
11T302L-KF																●		●	●		●					0.04~0.15	0.08~2.00	
11T304L-KF																●		●	●		●					0.05~0.16	0.10~2.00	
Finishing KF [Ultra high precision]	DCET 0702005MFR-KF															●			●							0.01~0.06	0.04~1.30	
	070201MFR-KF															●			●							0.02~0.08	0.05~1.50	
	070202MFR-KF															●			●							0.03~0.11	0.06~1.70	
	11T3005MFR-KF																●			●						0.02~0.08	0.05~1.50	
	11T301MFR-KF																●			●						0.03~0.11	0.06~1.70	
	11T302MFR-KF																●		●	●		●				0.04~0.15	0.08~2.00	
	0702005MFL-KF																●			●						0.01~0.06	0.04~1.30	
	070201MFL-KF																●			●							0.02~0.08	0.05~1.50
	070202MFL-KF																●			●							0.03~0.11	0.06~1.70
	11T3005MFL-KF																	●			●						0.02~0.08	0.05~1.50
	11T301MFL-KF																	●			●						0.03~0.11	0.06~1.70
	11T302MFL-KF																	●		●	●		●				0.04~0.15	0.08~2.00

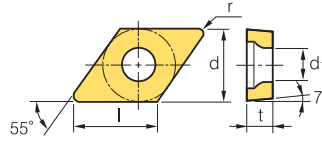
➡ Cutting edge geometry A37~A49
➡ Recommended chip breaker B04~B15
➡ Code system B34~B35
● : Stock item

Available tool holders			
Designation	Page	Designation	Page
SDACR/L	B190	SDQCR/L	B217
SDJCR/L	B123, 191	SDUCR/L	B218
SDNCN	B124, 191	SDZCR/L	B219



B Turning Insert (Positive)

DC



Dimensions (mm)			
Size	d	t	d ₁
07	6.35	2.38	2.8
11	9.525	3.97	4.4

Rhombic **55° Positive**
Relief Angle: 7°

Workpiece	Machining types															
	P	M	K	N	S	H										
Steel	●	●	●	●	●	●	●	●	●	●	●	●	●	●	●	●
Stainless steel	●	●	●	●	●	●	●	●	●	●	●	●	●	●	●	●
Cast iron	●	●	●	●	●	●	●	●	●	●	●	●	●	●	●	●
Non-ferrous metal	●	●	●	●	●	●	●	●	●	●	●	●	●	●	●	●
Heat resistant alloy, Titanium alloy	●	●	●	●	●	●	●	●	●	●	●	●	●	●	●	●
Hardened steel	●	●	●	●	●	●	●	●	●	●	●	●	●	●	●	●

● Continuous cutting
● General cutting
● Interrupted cutting

Inserts	Designation	Cermet		Coated		Coated										Uncoated		Cutting Condition											
		CN1500	CN2500	CC1500	CC2500	NC3215	NC3225	NC3120	NC3030	NC3235	NC5330	NC6310	NC6315	NC9115	NC9125	NC9135	PC5300	PC5400	PC8105	PC8110	PC8115	PC9030	H01	H05	f _n (mm/rev)	a _p (mm)			
Medium to finishing [High precision]	DCGT 0702003R-KM															●				●						0.01~0.06	0.04~1.30		
	070201R-KM															●				●							0.02~0.08	0.05~1.50	
	070202R-KM															●				●							0.03~0.11	0.06~1.50	
	070204R-KM															●				●							0.04~0.13	0.04~1.70	
	11T3003R-KM															●				●							0.02~0.08	0.05~1.50	
	11T301R-KM															●				●							0.03~0.11	0.06~1.70	
	11T302R-KM															●				●							0.04~0.15	0.08~2.00	
	11T304R-KM															●				●							0.05~0.16	0.10~2.00	
	0702003L-KM																●				●							0.01~0.06	0.04~1.30
	070201L-KM																●				●							0.02~0.08	0.05~1.50
	070202L-KM																●				●							0.03~0.11	0.06~1.50
	070204L-KM																●				●							0.04~0.13	0.04~1.70
	11T3003L-KM																●				●							0.02~0.08	0.05~1.50
	11T301L-KM																●				●							0.03~0.11	0.06~1.70
	11T302L-KM																●				●							0.04~0.15	0.08~2.00
11T304L-KM																●				●							0.05~0.16	0.10~2.00	
Medium to finishing [Ultra high precision]	DCET 0702005MFR-KM															●				●							0.01~0.06	0.04~1.30	
	070201MFR-KM															●				●								0.02~0.08	0.05~1.50
	070202MFR-KM															●				●								0.03~0.11	0.06~1.70
	11T3005MFR-KM															●				●								0.02~0.08	0.05~1.50
	11T301MFR-KM															●				●								0.03~0.11	0.06~1.70
	11T302MFR-KM															●				●								0.04~0.15	0.08~2.00
	0702005MFL-KM																●				●							0.01~0.06	0.04~1.30
	070201MFL-KM																●				●							0.02~0.08	0.05~1.50
	070202MFL-KM																●				●							0.03~0.11	0.06~1.70
	11T3005MFL-KM																●				●							0.02~0.08	0.05~1.50
	11T301MFL-KM																●				●							0.03~0.11	0.06~1.70
	11T302MFL-KM																●				●							0.04~0.15	0.08~2.00

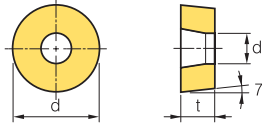
➡ Cutting edge geometry A37~A49 ➡ Recommended chip breaker B04~B15 ➡ Code system B34~B35 ● : Stock item

Available tool holders			
Designation	Page	Designation	Page
SDACR/L	B190	SDQCR/L	B217
SDJCR/L	B123, 191	SDUCR/L	B218
SDNCN	B124, 191	SDZCR/L	B219



RC

Round R° Positive
Relief Angle: 7°



Dimensions (mm)			
Size	d	t	d ₁
08	8.0	3.18	3.35
10	10.0	3.97	3.6
12	12.0	4.76	4.2
16	16.0	6.35	5.2
20	20.0	6.35	6.5
25	25.0	7.94	7.25
32	32.0	9.52	9.55

Workpiece	Machining types																											
	P	M	K	N	S	H	●	●	●	●	●	●	●	●	●	●	●	●	●	●	●	●	●	●	●	●	●	●
Steel	●	●	●	●	●	●	●	●	●	●	●	●	●	●	●	●	●	●	●	●	●	●	●	●	●	●	●	●
Stainless steel	●	●	●	●	●	●	●	●	●	●	●	●	●	●	●	●	●	●	●	●	●	●	●	●	●	●	●	●
Cast iron	●	●	●	●	●	●	●	●	●	●	●	●	●	●	●	●	●	●	●	●	●	●	●	●	●	●	●	●
Non-ferrous metal	●	●	●	●	●	●	●	●	●	●	●	●	●	●	●	●	●	●	●	●	●	●	●	●	●	●	●	●
Heat resistant alloy, Titanium alloy	●	●	●	●	●	●	●	●	●	●	●	●	●	●	●	●	●	●	●	●	●	●	●	●	●	●	●	●
Hardened steel	●	●	●	●	●	●	●	●	●	●	●	●	●	●	●	●	●	●	●	●	●	●	●	●	●	●	●	●

Inserts	Designation	Cermets		Coated														Uncoated		Cutting Condition									
		CN1500	CN2500	CC1500	CC2500	NC3215	NC3225	NC3120	NC3030	NC3235	NC5330	NC6310	NC6315	NC9115	NC9125	NC9135	PC5300	PC5400	PC8105	PC8110	PC8115	PC9030	H01	H05	f _n (mm/rev)	a _p (mm)			
Medium cutting		RCMT 0803M0-VM																								0.05~0.30	0.80~2.50		
		10T3M0-VM																									0.05~0.35	0.90~3.00	
		1204M0-VM																										0.10~0.50	1.00~3.50
		1606M0-VM																										0.13~0.60	1.30~6.50
Medium cutting		RCMX 1003M0					●	●	●	●	●	●	●	●	●	●	●	●	●	●	●	●	●	●	●	●	0.25~0.50	1.50~4.00	
		1204M0					●	●	●	●	●	●	●	●	●	●	●	●	●	●	●	●	●	●	●	●	0.30~0.60	2.50~5.00	
		1606M0					●	●	●	●	●	●	●	●	●	●	●	●	●	●	●	●	●	●	●	●	0.40~0.70	3.00~7.00	
		2006M0							●	●	●	●	●	●	●	●	●	●	●	●	●	●	●	●	●	●	0.48~0.90	3.50~9.00	
		2507M0								●	●	●	●	●	●	●	●	●	●	●	●	●	●	●	●	●	0.55~1.20	4.00~12.00	
		3209M0								●	●	●	●	●	●	●	●	●	●	●	●	●	●	●	●	●	0.65~1.50	5.00~15.00	

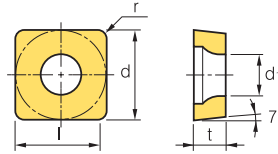
Cutting edge geometry **A37~A49**
 Recommended chip breaker **B04~B15**
 Code system **B34~B35**
 ● : Stock item

Available tool holders			
Designation	Page	Designation	Page
PRDCN	B174	PRGCR/L	B175



B Turning Insert (Positive)


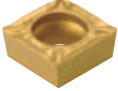
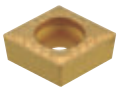



SC



Dimensions (mm)			
Size	d	t	d ₁
09	9.525	3.97	4.4
12	12.0	4.76	4.2

Square 90° Positive
Relief Angle: 7°

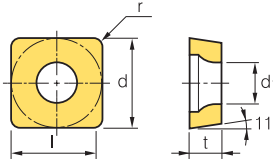
Workpiece	Machining types											
	P	M	K	N	S	H						
Steel	●	●	●	●	●	●	●	●	●	●	●	●
Stainless steel	●	●	●	●	●	●	●	●	●	●	●	●
Cast iron	●	●	●	●	●	●	●	●	●	●	●	●
Non-ferrous metal	●	●	●	●	●	●	●	●	●	●	●	●
Heat resistant alloy, Titanium alloy	●	●	●	●	●	●	●	●	●	●	●	●
Hardened steel	●	●	●	●	●	●	●	●	●	●	●	●

Inserts	Designation	Cermets		Coated		Coated												Uncoated		Cutting Condition								
		CN1500	CN2500	CC1500	CC2500	NC3215	NC3225	NC3120	NC3030	NC3235	NC5330	NC6310	NC6315	NC9115	NC9125	NC9135	PC5300	PC5400	PC8105	PC8110	PC8115	PC9030	H01	H05	f _n (mm/rev)	a _p (mm)		
Finishing  [Mild steel]	SCMT 09T304-FP 09T308-FP	●	●	●	●	●	●	●	●	●	●	●	●	●	●	●	●	●	●	●	●	●	●	●	●	0.01-0.10	0.10~1.00	
		●	●	●	●	●	●	●	●	●	●	●	●	●	●	●	●	●	●	●	●	●	●	●	●	●	0.04-0.12	0.10~1.00
Finishing 	SCMT 09T304-VF					●										●										0.05~0.20	0.30~1.50	
Finishing 	SCMT 09T304-VL 09T308-VL	●	●	●	●	●	●	●	●	●	●	●	●	●	●	●	●	●	●	●	●	●	●	●	●	0.05~0.10	0.10~1.00	
		●	●	●	●	●	●	●	●	●	●	●	●	●	●	●	●	●	●	●	●	●	●	●	●	0.08-0.15	0.10~1.00	
Medium to finishing 	SCMT 09T304-HMP 09T308-HMP 120404-HMP 120408-HMP							●	●							●									0.08-0.23	0.30~3.00		
								●	●								●									0.10-0.30	0.50~3.00	
										●	●							●									0.09-0.27	0.30~3.60
										●	●							●									0.12-0.36	0.60~3.60
Medium to finishing 	SCMT 09T304-MP 09T308-MP 120404-MP 120408-MP 120412-MP					●	●					●	●	●	●	●	●	●	●	●	●	●	●	●	●	0.05-0.25	0.30~2.80	
						●	●					●	●	●	●	●	●	●	●	●	●	●	●	●	●	0.10-0.30	0.50~2.80	
						●	●							●	●	●	●	●	●	●	●	●	●	●	●	0.10-0.30	0.50~2.80	
						●	●							●	●	●	●	●	●	●	●	●	●	●	●	0.15~0.35	0.80~3.50	
						●	●							●	●	●	●	●	●	●	●	●	●	●	●	0.25-0.40	1.00~3.50	
Medium to finishing 	SCMT 060204-C25 09T304-C25 09T308-C25 120404-C25 120408-C25							●																	0.08-0.25	0.40~2.50		
		●	●	●	●	●	●	●	●	●	●	●	●	●	●	●	●	●	●	●	●	●	●	●	●	0.08-0.25	0.60~3.00	
		●	●	●	●	●	●	●	●	●	●	●	●	●	●	●	●	●	●	●	●	●	●	●	●	0.10-0.30	1.00~3.00	
		●	●	●	●	●	●	●	●	●	●	●	●	●	●	●	●	●	●	●	●	●	●	●	●	0.10-0.30	0.80~3.80	
		●	●	●	●	●	●	●	●	●	●	●	●	●	●	●	●	●	●	●	●	●	●	●	●	0.12-0.38	1.20~3.80	

➔ Cutting edge geometry A37~A49 ➔ Recommended chip breaker B04~B15 ➔ Code system B34~B35 ● : Stock item

Available tool holders			
Designation	Page	Designation	Page
SSBCR/L	B192	SSKCR/L	B193, 219
SSDCN	B192	SSSCR/L	B193, 245





Dimensions (mm)			
Size	d	t	d ₁
09	9.525	3.18	3.4
12	12.7	4.76	-
15	15.875	4.76	-
19	19.05	4.76	-
25	25.4	6.35	-

Square **90° Positive**
 Relief Angle: 11°

Workpiece	Material	Color	Machining types																	
			●	●	●	●	●	●	●	●	●	●	●	●	●	●	●	●	●	●
Steel	P	Blue	●	●	●	●	●	●	●	●	●	●	●	●	●	●	●	●	●	●
Stainless steel	M	Yellow	●	●	●	●	●	●	●	●	●	●	●	●	●	●	●	●	●	●
Cast iron	K	Red	●	●	●	●	●	●	●	●	●	●	●	●	●	●	●	●	●	●
Non-ferrous metal	N	Green																		
Heat resistant alloy, Titanium alloy	S	Orange																		
Hardened steel	H	Grey																		

● Continuous cutting
 ● General cutting
 ● Interrupted cutting

Inserts	Designation	Cermet		Coated		Coated													Uncoated		Cutting Condition						
		CN1500	CN2500	CC1500	CC2500	NC3215	NC3225	NC3120	NC3030	NC3235	NC5330	NC6310	NC6315	NC9115	NC9125	NC9135	PC5300	PC5400	PC8105	PC8110	PC8115	PC9030	H01	H05	f _n (mm/rev)	a _p (mm)	
Finishing 	SPMT 09T304-VL																								0.04~0.18	0.20~1.40	
	09T308-VL																									0.08~0.22	0.20~1.40
Finishing 	SPMT 090304-VF																								0.05~0.20	0.30~1.50	
	090308-VF																									0.10~0.25	0.30~1.50
Finishing 	SPMR 090304-F							●	●																0.05~0.20	0.30~2.00	
	120304-F							●	●																	0.10~0.25	0.50~2.00
Finishing 	SPGR 090304-F																								0.05~0.20	0.30~2.00	
	120304-F																									0.10~0.25	0.50~2.00
Medium cutting 	SPMR 090308-M							●	●																0.10~0.40	1.00~3.50	
	120308-M							●	●																	0.10~0.40	1.50~4.00
	120312-M								●																	0.20~0.40	1.50~4.00
Medium cutting 	SPGR 090308-M																								0.10~0.40	1.00~3.50	
	120308-M																									0.20~0.40	1.50~4.00
Medium to finishing 	SPUN 120304																								0.10~0.30	1.00~5.00	
	120308																									0.15~0.40	1.00~5.00
	120308SN																									0.15~0.40	1.00~5.00
	150412																									0.20~0.50	1.00~5.00
	190412																									0.20~0.50	1.50~7.00
	190416																									0.25~0.60	2.00~7.00
250620																									0.30~0.80	3.00~10.0	

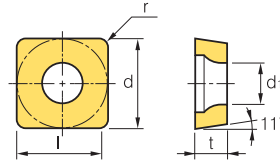
Cutting edge geometry **A37~A49**
 Recommended chip breaker **B04~B15**
 Code system **B34~B35**
 ● : Stock item

Available tool holders			
Designation	Page	Designation	Page
CSDPN	B181	SSKPR/L	B219
CSKPR/L	B182		



B Turning Insert (Positive)

SP



Dimensions (mm)			
Size	d	t	d ₁
06	6.35	2.38	2.8
07	6.35	2.38	2.8
09	9.525	3.18	3.4~4.4
12	12.7	3.18	-
15	15.875	4.76	-
19	19.05	4.76	-

Square 90° Positive
Relief Angle: 11°

Workpiece	Material	Grade	Machining types															
			●	⊛	●	⊛	●	⊛	●	⊛	●	⊛	●	⊛	●	⊛	●	⊛
Steel		P	●	⊛	●	⊛	●	⊛	●	⊛	●	⊛	●	⊛	●	⊛	●	⊛
Stainless steel		M	●	⊛	●	⊛	●	⊛	●	⊛	●	⊛	●	⊛	●	⊛	●	⊛
Cast iron		K	●	⊛	●	⊛	●	⊛	●	⊛	●	⊛	●	⊛	●	⊛	●	⊛
Non-ferrous metal		N																
Heat resistant alloy, Titanium alloy		S																
Hardened steel		H																

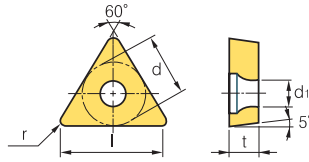
Inserts	Designation	Cermet		Coated		Coated														Uncoated		Cutting Condition					
		CN1500	CN2500	CC1500	CC2500	NC3215	NC3225	NC3120	NC3030	NC3235	NC5330	NC6310	NC6315	NC9115	NC9125	NC9135	PC5300	PC5400	PC8105	PC8110	PC8115	PC9030	H01	H05	f _n (mm/rev)	a _p (mm)	
Medium to finishing	SPGN 070202																								0.03-0.10	0.50-2.00	
	070208																									0.10-0.25	0.70-3.00
	090302																									0.03-0.10	0.50-3.00
	090304																									0.08-0.20	0.70-3.50
	090308																									0.10-0.25	0.70-3.50
	120302																									0.03-0.20	0.50-3.00
	120304																									0.08-0.20	1.00-5.00
	120308								●																	0.10-0.25	1.00-5.00
	120312																									0.15-0.30	1.00-5.00
	120316																									0.18-0.33	1.00-5.00
	120402																									0.03-0.20	0.50-3.00
	120404																									0.08-0.20	1.00-5.00
	120408																									0.10-0.25	1.00-5.00
	120412																									0.15-0.30	1.00-5.00
	120416																									0.18-0.33	1.00-5.00
	120430																									0.20-0.60	2.00-5.00
	120440																									0.25-0.70	3.00-5.00
	150404																									0.08-0.20	1.50-7.00
	150408																									0.10-0.25	1.50-7.00
	150412																									0.15-0.30	1.50-7.00
150416																									0.18-0.33	1.50-7.00	
150420																									0.20-0.45	1.50-7.00	
190404																									0.08-0.20	1.50-9.00	
190408																									0.10-0.25	1.50-9.00	
190412																									0.15-0.45	1.50-9.00	
190416																									0.18-0.60	1.50-9.00	
190424																									0.25-0.70	2.50-9.00	
Medium to finishing	SPGA 060204																								0.50-0.25	0.50-2.00	
	090308T	●																							0.10-0.25	0.70-3.00	
	090308T-Z																								0.10-0.25	0.70-3.00	
Medium to finishing	SPGT 090304R																								0.08-0.23	0.30-3.00	
	090308R																								0.10-0.30	0.50-3.00	
	090304L																								0.08-0.23	0.30-3.00	
	090308L																								0.10-0.30	0.50-3.00	

🔄 Cutting edge geometry **A37~A49**
 🔄 Recommended chip breaker **B04~B15**
 🔄 Code system **B34~B35**
 ● : Stock item

Available tool holders			
Designation	Page	Designation	Page
CSDPN	B181	SSKPR/L	B219
CSKPR/L	B182		



TB



Dimensions (mm)			
Size	d	t	d ₁
06	3.97	1.59	2.16

Triangular 60° Positive
Relief Angle: 5°

Workpiece	Machining types																							
	P	M	K	N	S	H	NC3215	NC3225	NC3120	NC3030	NC3235	NC5330	NC6310	NC6315	NC9115	NC9125	NC9135	PC5300	PC5400	PC8105	PC8110	PC8115	PC9030	
Steel	●	●	●	●	●	●	●	●	●	●	●	●	●	●	●	●	●	●	●	●	●	●	●	●
Stainless steel	●	●	●	●	●	●	●	●	●	●	●	●	●	●	●	●	●	●	●	●	●	●	●	●
Cast iron	●	●	●	●	●	●	●	●	●	●	●	●	●	●	●	●	●	●	●	●	●	●	●	●
Non-ferrous metal	●	●	●	●	●	●	●	●	●	●	●	●	●	●	●	●	●	●	●	●	●	●	●	●
Heat resistant alloy, Titanium alloy	●	●	●	●	●	●	●	●	●	●	●	●	●	●	●	●	●	●	●	●	●	●	●	●
Hardened steel	●	●	●	●	●	●	●	●	●	●	●	●	●	●	●	●	●	●	●	●	●	●	●	●

Inserts	Designation	Cermet		Coated														Uncoated		Cutting Condition							
		CN1500	CN2500	CC1500	CC2500	NC3215	NC3225	NC3120	NC3030	NC3235	NC5330	NC6310	NC6315	NC9115	NC9125	NC9135	PC5300	PC5400	PC8105	PC8110	PC8115	PC9030	H01	H05	f _n (mm/rev)	a _p (mm)	
Finishing	VL	TBMT 060102-VL																								0.03~0.06	0.05~0.60
		TBGT 060102L																						●	●	0.05~0.20	0.10~1.30
Finishing	VL	060104L																								0.08~0.20	0.10~1.30

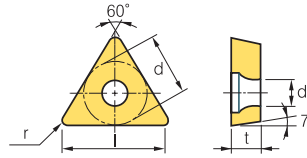
➡ Cutting edge geometry **A37~A49**
 ➡ Recommended chip breaker **B04~B15**
 ➡ Code system **B34~B35**
 ● : Stock item

Available tool holders	
Designation	Page
STUBR/L	B225

B Turning Insert (Positive)






TC

Triangular 60° Positive
Relief Angle: 7°



Dimensions (mm)			
Size	d	t	d ₁
06	6.35	2.38	2.8
09	5.56	2.38	2.5
11	6.35	2.38	2.8
16	9.525	3.97	4.4
22	12.7	4.76	-

Workpiece	Machining types															
	P	M	K	N	S	H										
Steel	●	●	●	●	●	●	●	●	●	●	●	●	●	●	●	●
Stainless steel	●	●	●	●	●	●	●	●	●	●	●	●	●	●	●	●
Cast iron	●	●	●	●	●	●	●	●	●	●	●	●	●	●	●	●
Non-ferrous metal	●	●	●	●	●	●	●	●	●	●	●	●	●	●	●	●
Heat resistant alloy, Titanium alloy	●	●	●	●	●	●	●	●	●	●	●	●	●	●	●	●
Hardened steel	●	●	●	●	●	●	●	●	●	●	●	●	●	●	●	●

Inserts	Designation	Cermet		Coated		Coated											Uncoated		Cutting Condition								
		CN1500	CN2500	CC1500	CC2500	NC3215	NC3225	NC3120	NC3030	NC3235	NC5330	NC6310	NC6315	NC9115	NC9125	NC9135	PC5300	PC5400	PC8105	PC8110	PC8115	PC9030	H01	H05	f _n (mm/rev)	a _p (mm)	
Finishing  [Mild steel]	TCMT 060201-FP																								0.00-0.08	0.05-0.07	
	110202-FP		●			●																				0.01-0.10	0.05-0.08
	110204-FP		●			●																				0.01-0.10	0.10-0.90
Finishing 	TCMT 110202-VF																								0.03-0.13	0.06-0.70	
	110204-VF																●								0.05-0.20	0.30-1.20	
	110208-VF																●								0.10-0.25	0.30-1.20	
	16T302-VF																●								0.05-0.15	0.10-1.30	
	16T304-VF							●			●						●									0.05-0.20	0.30-1.50
Finishing 	TCMT 090208-VL																								0.08-0.20	0.10-1.20	
	110204-VL																								0.05-0.15	0.10-1.30	
	110208-VL																								0.08-0.20	0.10-1.30	
	16T304-VL	●	●	●	●	●	●					●	●	●	●	●	●	●	●	●	●	●	●	●	0.05-0.20	0.30-1.50	
	16T308-VL	●	●	●	●	●	●				●	●	●	●	●	●	●	●	●	●	●	●	●	●	0.05-0.20	0.30-1.50	
Medium to finishing 	TCMT 090204-HMP								●																0.06-0.17	0.20-2.30	
	090208-HMP																								0.08-0.23	0.40-2.30	
	110202-HMP																								0.03-0.15	0.10-1.50	
	110204-HMP		●				●	●	●		●					●			●		●				0.06-0.19	0.20-2.50	
	110208-HMP																●								0.09-0.26	0.40-2.50	
	16T304-HMP		●					●	●		●					●			●		●				0.08-0.23	0.30-3.00	
	16T308-HMP							●	●		●					●			●		●				0.10-0.30	0.50-3.00	
Medium to finishing 	TCMT 090204-MP														●	●	●								0.05-0.18	0.10-1.00	
	090208-MP														●	●	●								0.08-0.20	0.10-1.20	
	110202-MP							●	●			●								●	●				0.03-0.12	0.20-1.50	
	110204-MP							●	●			●				●				●	●				0.05-0.15	0.20-1.50	
	110208-MP							●	●			●				●				●	●				0.10-0.28	0.25-2.00	
	16T302-MP																								0.08-0.25	0.20-1.50	
	16T304-MP	●	●	●	●	●	●			●		●	●	●	●	●	●	●	●	●	●	●	●	●	0.08-0.20	0.30-2.50	
	16T308-MP	●	●	●	●	●	●			●		●	●	●	●	●	●	●	●	●	●	●	●	●	0.10-0.30	0.50-2.50	
	16T312-MP							●	●			●				●				●					0.20-0.40	0.50-2.50	
	220408-MP																								0.20-0.40	0.50-3.50	

 Cutting edge geometry A37~A49
  Recommended chip breaker B04~B15
  Code system B34~B35
 ● : Stock item

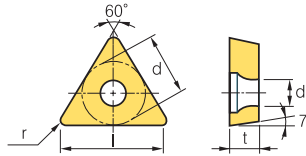
Available tool holders			
Designation	Page	Designation	Page
STACR/L	B124, 193	STTCR/L	B194, 246
STFCR/L	B194, 245	STWCR/L	B246
STGCR/L	B194		



TC



Triangular 60° Positive
Relief Angle: 7°



Dimensions (mm)			
Size	d	t	d ₁
08	8.0	3.18	3.35
09	5.56	2.38	2.5
11	6.35	2.38	2.8
16	9.525	3.97	4.4

Workpiece	Steel	P	●	✱	●	✱	●	✱	✱	✱	●	●	●	✱	Machining types	
	Stainless steel	M														
Cast iron	K															● General cutting
Non-ferrous metal	N															✱ Interrupted cutting
Heat resistant alloy, Titanium alloy	S															
Hardened steel	H															

Inserts	Designation	Cermet	Coated	Coated													Uncoated		Cutting Condition									
				CN1500	CN2500	CC1500	CC2500	NC3215	NC3225	NC3120	NC3030	NC3235	NC5330	NC6310	NC6315	NC9115	NC9125	NC9135	PC5300	PC5400	PC8105	PC8110	PC8115	PC9030	H01	H05	f _n (mm/rev)	a _p (mm)
Medium cutting C25	TCMT 090204-C25	●	●	●	●	●	●	●	●	●	●	●	●	●	●	●	●	●	●	●	●	●	●	●	●	●	0.06~0.18	0.40~2.50
	090208-C25	●	●	●	●	●	●	●	●	●	●	●	●	●	●	●	●	●	●	●	●	●	●	●	●	●	0.08~0.25	0.80~2.50
	110202-C25	●	●	●	●	●	●	●	●	●	●	●	●	●	●	●	●	●	●	●	●	●	●	●	●	●	0.04~0.12	0.40~2.00
	110204-C25	●	●	●	●	●	●	●	●	●	●	●	●	●	●	●	●	●	●	●	●	●	●	●	●	●	0.06~0.20	0.60~2.50
	110208-C25	●	●	●	●	●	●	●	●	●	●	●	●	●	●	●	●	●	●	●	●	●	●	●	●	●	0.08~0.25	0.80~2.50
	16T304-C25	●	●	●	●	●	●	●	●	●	●	●	●	●	●	●	●	●	●	●	●	●	●	●	●	●	0.08~0.28	0.80~3.00
	16T308-C25	●	●	●	●	●	●	●	●	●	●	●	●	●	●	●	●	●	●	●	●	●	●	●	●	●	0.10~0.30	1.00~3.00
Finishing VP1	TCMT 16T304-VP1																									0.06~0.20	0.10~1.50	
	16T308-VP1																									0.08~0.23	0.10~1.50	
Finishing FS [High precision]	TCGT 110201-FS																●			●						0.01~0.16	0.03~1.40	
	110202-FS																●			●						0.02~0.18	0.04~1.50	
	110204-FS																●			●						0.04~0.19	0.06~1.60	
Finishing FS [Ultra high precision]	TCGT 110201MFN-FS																									0.01~0.16	0.03~1.40	
	110202MFN-FS																									0.02~0.18	0.04~1.50	
	110204MFN-FS																									0.04~0.19	0.06~1.60	
Finishing VP1	TCGT 090204-VP1																									0.04~0.18	0.10~1.00	
	16T304-VP1																									0.06~0.20	0.10~1.50	
	16T308-VP1																									0.08~0.23	0.10~1.50	
Finishing KF [High precision]	TCGT 0802003R-KF																									0.01~0.06	0.04~1.30	
	080201R-KF																									0.02~0.08	0.05~1.50	
	080202R-KF																									0.03~0.11	0.06~1.70	
	0802003L-KF																									0.01~0.06	0.04~1.30	
	080201L-KF																									0.02~0.08	0.05~1.50	
	080202L-KF																									0.03~0.11	0.06~1.70	

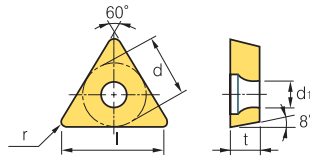
Cutting edge geometry **A37~A49**
 Recommended chip breaker **B04~B15**
 Code system **B34~B35**
● : Stock item

Available tool holders			
Designation	Page	Designation	Page
STACR/L	B124, 193	STTCR/L	B194, 246
STFCR/L	B194, 245	STWCR/L	B246
STGCR/L	B194		



B Turning Insert (Positive)

TO



Dimensions (mm)			
Size	d	t	d ₁
06	3.97	1.59	2.15
09	5.56	2.38	2.8
14	8.2	3.0	3.8

Triangular 60° Positive
Relief Angle: 8°

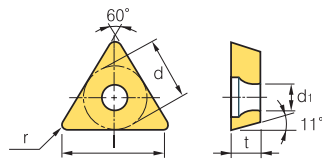
Workpiece	Machining types																							
	P	M	K	N	S	H	NC3215	NC3225	NC3120	NC3030	NC3235	NC5330	NC6310	NC6315	NC9115	NC9125	NC9135	PC5300	PC5400	PC8105	PC8110	PC8115	PC9030	
Steel	●	●	●	●	●	●	●	●	●	●	●	●	●	●	●	●	●	●	●	●	●	●	●	●
Stainless steel	●	●	●	●	●	●	●	●	●	●	●	●	●	●	●	●	●	●	●	●	●	●	●	●
Cast iron	●	●	●	●	●	●	●	●	●	●	●	●	●	●	●	●	●	●	●	●	●	●	●	●
Non-ferrous metal	●	●	●	●	●	●	●	●	●	●	●	●	●	●	●	●	●	●	●	●	●	●	●	●
Heat resistant alloy, Titanium alloy	●	●	●	●	●	●	●	●	●	●	●	●	●	●	●	●	●	●	●	●	●	●	●	●
Hardened steel	●	●	●	●	●	●	●	●	●	●	●	●	●	●	●	●	●	●	●	●	●	●	●	●

Inserts	Designation	Cermet		Coated													Uncoated		Cutting Condition								
		CN1500	CN2500	CC1500	CC2500	NC3215	NC3225	NC3120	NC3030	NC3235	NC5330	NC6310	NC6315	NC9115	NC9125	NC9135	PC5300	PC5400	PC8105	PC8110	PC8115	PC9030	H01	H05	f _n (mm/rev)	a _p (mm)	
Medium to finishing	TOEH	060102L	●	●	●	●	●	●	●	●	●	●	●	●	●	●	●	●	●	●	●	●	●	●	●	0.05~0.17	0.10~1.50
		090204L	●	●	●	●	●	●	●	●	●	●	●	●	●	●	●	●	●	●	●	●	●	●	●	0.05~0.20	0.30~2.50
		140304L	●	●	●	●	●	●	●	●	●	●	●	●	●	●	●	●	●	●	●	●	●	●	●	0.05~0.25	0.30~2.50

⌚ Cutting edge geometry A37~A49 ⌚ Recommended chip breaker B04~B15 ⌚ Code system B34~B35 ● : Stock item

Available tool holders			
Designation	Page	Designation	Page
STFPR/L	B221	STUPR/L	B226
CTFPR/L	B182	CTGPR/L	B182

TP



Dimensions (mm)			
Size	d	t	d ₁
09	5.56	2.38	3.0
11	6.35	3.18	3.4
16	9.525	3.18~4.76	4.4

Triangular 60° Positive
Relief Angle: 11°

Workpiece	Machining types																							
	P	M	K	N	S	H	NC3215	NC3225	NC3120	NC3030	NC3235	NC5330	NC6310	NC6315	NC9115	NC9125	NC9135	PC5300	PC5400	PC8105	PC8110	PC8115	PC9030	
Steel	●	●	●	●	●	●	●	●	●	●	●	●	●	●	●	●	●	●	●	●	●	●	●	●
Stainless steel	●	●	●	●	●	●	●	●	●	●	●	●	●	●	●	●	●	●	●	●	●	●	●	●
Cast iron	●	●	●	●	●	●	●	●	●	●	●	●	●	●	●	●	●	●	●	●	●	●	●	●
Non-ferrous metal	●	●	●	●	●	●	●	●	●	●	●	●	●	●	●	●	●	●	●	●	●	●	●	●
Heat resistant alloy, Titanium alloy	●	●	●	●	●	●	●	●	●	●	●	●	●	●	●	●	●	●	●	●	●	●	●	●
Hardened steel	●	●	●	●	●	●	●	●	●	●	●	●	●	●	●	●	●	●	●	●	●	●	●	●

Inserts	Designation	Cermet		Coated													Uncoated		Cutting Condition								
		CN1500	CN2500	CC1500	CC2500	NC3215	NC3225	NC3120	NC3030	NC3235	NC5330	NC6310	NC6315	NC9115	NC9125	NC9135	PC5300	PC5400	PC8105	PC8110	PC8115	PC9030	H01	H05	f _n (mm/rev)	a _p (mm)	
Finishing	TPMT	090202-FP	●	●	●	●	●	●	●	●	●	●	●	●	●	●	●	●	●	●	●	●	●	●	●	0.01~0.09	0.05~0.07
		090204-FP	●	●	●	●	●	●	●	●	●	●	●	●	●	●	●	●	●	●	●	●	●	●	●	0.01~0.09	0.10~0.08
		110302-FP	●	●	●	●	●	●	●	●	●	●	●	●	●	●	●	●	●	●	●	●	●	●	●	0.01~0.10	0.05~0.08
		110304-FP	●	●	●	●	●	●	●	●	●	●	●	●	●	●	●	●	●	●	●	●	●	●	●	0.01~0.10	0.10~0.90
		110308-FP	●	●	●	●	●	●	●	●	●	●	●	●	●	●	●	●	●	●	●	●	●	●	●	0.04~0.10	0.10~1.00
		160404-FP	●	●	●	●	●	●	●	●	●	●	●	●	●	●	●	●	●	●	●	●	●	●	●	0.01~0.10	0.10~1.00
		160408-FP	●	●	●	●	●	●	●	●	●	●	●	●	●	●	●	●	●	●	●	●	●	●	●	0.04~0.12	0.10~1.00

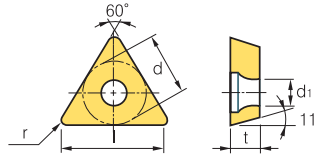
⌚ Cutting edge geometry A37~A49 ⌚ Recommended chip breaker B04~B15 ⌚ Code system B34~B35 ● : Stock item

Available tool holders			
Designation	Page	Designation	Page
STFPR/L	B221	STUPR/L	B226
CTFPR/L	B182	CTGPR/L	B182



TP

Triangular 60° Positive
Relief Angle: 11°



Dimensions (mm)			
Size	d	t	d ₁
09	5.56	2.38	3.0
11	6.35	3.18	3.4
16	9.525	3.18~4.76	4.4
22	12.7	4.76	-

Workpiece	Material												Machining types				
	Steel	Stainless steel	Cast iron	Non-ferrous metal	Heat resistant alloy, Titanium alloy	Hardened steel	P	M	K	N	S	H	●	⊙	●	⊙	
Steel	●	●	●	●	●	●	●	●	●	●	●	●	●	●	●	●	●
Stainless steel	●	●	●	●	●	●	●	●	●	●	●	●	●	●	●	●	●
Cast iron	●	●	●	●	●	●	●	●	●	●	●	●	●	●	●	●	●
Non-ferrous metal	●	●	●	●	●	●	●	●	●	●	●	●	●	●	●	●	●
Heat resistant alloy, Titanium alloy	●	●	●	●	●	●	●	●	●	●	●	●	●	●	●	●	●
Hardened steel	●	●	●	●	●	●	●	●	●	●	●	●	●	●	●	●	●

Inserts	Designation	Cermet		Coated		Coated											Uncoated		Cutting Condition										
		CN1500	CN2500	CC1500	CC2500	NC3215	NC3225	NC3120	NC3030	NC3235	NC5330	NC6310	NC6315	NC9115	NC9125	NC9135	PC5300	PC5400	PC8105	PC8110	PC8115	PC9030	H01	H05	f _n (mm/rev)	a _p (mm)			
Finishing 	TPMT	110304-VF				●				●						●				●						0.05~0.20	0.30~1.50		
		110308-VF				●				●										●							0.10~0.25	0.30~1.50	
		160404-VF																									0.05~0.20	0.30~2.00	
		160408-VF																									0.10~0.25	0.30~2.00	
Finishing 	TPMT	090204-VL																								0.04~0.10	0.10~0.90		
		090208-VL																								0.06~0.12	0.10~1.00		
		110304-VL	●	●	●	●	●	●			●		●	●	●	●	●	●	●	●	●	●					0.05~0.15	0.10~1.30	
		110308-VL					●						●	●													0.08~0.20	0.10~1.30	
		160404-VL																									0.05~0.20	0.30~1.50	
		160408-VL																									0.05~0.20	0.30~1.50	
Medium to finishing 	TPMT	090202-MP																								0.03~0.15	0.10~1.00		
		090204-MP																									0.05~0.18	0.10~1.00	
		110302-MP																									0.03~0.12	0.20~1.50	
		110304-MP	●	●	●	●	●	●					●	●	●	●											0.05~0.20	0.20~1.50	
		110308-MP					●	●					●	●														0.10~0.28	0.30~2.00
		160402-MP																									0.06~0.20	0.30~2.50	
		160404-MP					●	●																			0.08~0.20	0.30~2.50	
		160408-MP					●	●																			0.10~0.30	0.50~2.50	
Finishing 	TPMR	090202-F																								0.05~0.15	0.10~1.00		
		090204-F																									0.05~0.15	0.10~1.00	
		110302-F																									0.05~0.15	0.10~1.50	
		110304-F					●	●	●			●															0.05~0.20	0.30~1.50	
		110308-F																									0.05~0.25	0.30~1.50	
		160304-F					●	●	●		●																0.08~0.25	0.50~2.00	
		160308-F																									0.08~0.25	0.50~3.00	
Finishing 	TPGR	110302-F																								0.05~0.15	0.10~1.50		
		110304-F																								0.05~0.20	0.30~1.50		
		160304-F																								0.08~0.25	0.50~2.00		
Medium cutting 	TPMR	110304-M																								0.10~0.25	0.70~3.00		
		110308-M							●			●														0.13~0.30	1.00~3.00		
		160304-M								●		●														0.10~0.25	1.00~5.00		
		160308-M							●	●	●		●													0.13~0.30	1.00~5.00		
		160312-M								●																0.15~0.35	1.00~5.00		
		220408-M							●																	0.13~0.30	1.50~7.00		

Cutting edge geometry **A37~A49**
 Recommended chip breaker **B04~B15**
 Code system **B34~B35**
 ● : Stock item

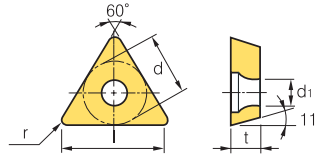
Available tool holders			
Designation	Page	Designation	Page
STFPR/L	B221	STUPR/L	B226
CTFPR/L	B182	CTGPR/L	B182



B Turning Insert (Positive)

TP

Triangular 60° Positive
Relief Angle: 11°



Dimensions (mm)			
Size	d	t	d ₁
09	5.56	2.38	-
11	6.35	2.38~3.18	3.4
16	9.525	3.18~4.76	4.4
22	12.7	4.76	-
27	15.875	4.76~6.35	-
33	19.05	7.94~9.52	7.93

Workpiece	Machining types												
	P	M	K	N	S	H							
Steel	●	●	●	●	●	●	●	●	●	●	●	●	●
Stainless steel	●	●	●	●	●	●	●	●	●	●	●	●	●
Cast iron	●	●	●	●	●	●	●	●	●	●	●	●	●
Non-ferrous metal	●	●	●	●	●	●	●	●	●	●	●	●	●
Heat resistant alloy, Titanium alloy	●	●	●	●	●	●	●	●	●	●	●	●	●
Hardened steel	●	●	●	●	●	●	●	●	●	●	●	●	●

Inserts	Designation	Cermet		Coated		Coated													Uncoated		Cutting Condition							
		CN1500	CN2500	CC1500	CC2500	NC3215	NC3225	NC3120	NC3030	NC3235	NC5330	NC6310	NC6315	NC9115	NC9125	NC9135	PC5300	PC5400	PC8105	PC8110	PC8115	PC9030	PC9030	H05	f _n (mm/rev)	a _p (mm)		
Medium cutting	M	TPGR	110308-M																							0.13-0.30	1.00-3.00	
			160308-M																									0.13-0.30
Medium to finishing	M	TPUN	090308																							0.10-0.30	0.50-2.00	
			110208																								0.15-0.40	1.00-3.00
			110304																								0.10-0.30	1.00-3.00
			110308																								0.15-0.40	1.00-3.00
			160304							●																	0.10-0.30	1.00-5.00
			160308							●							●										0.15-0.40	1.00-5.00
			160308TN																								0.15-0.40	1.00-5.00
			160312																								0.20-0.50	1.50-5.00
			160312TN																								0.20-0.50	1.50-5.00
			220404																								0.10-0.30	1.50-7.00
			220408									●															0.15-0.40	1.50-7.00
			220412																								0.20-0.50	1.50-7.00
			220412TN																								0.20-0.50	1.50-7.00
			330620																								0.30-0.70	3.00-10.00
Medium to finishing	M	TPGN	090204																						0.07-0.20	0.70-2.00		
			110302																							0.05-0.15	0.50-2.00	
			110304									●												●		0.07-0.20	0.70-3.00	
			110308									●												●		0.10-0.25	1.00-3.00	
			160302																							0.05-0.18	1.00-5.00	
			160304							●		●												●		0.07-0.20	1.00-5.00	
			160308							●		●												●		0.10-0.25	1.00-5.00	
			160310																							0.10-0.25	1.00-5.00	
			160312																							0.15-0.30	1.00-5.00	
			160316																							0.15-0.30	1.00-5.00	
			160404																							0.07-0.20	1.00-5.00	
			220404										●													0.07-0.20	1.50-7.00	
			220408										●													0.10-0.25	1.50-7.00	
			220412										●													0.15-0.30	1.50-7.00	
			220430																							0.30-0.45	1.50-7.00	
			220440																							0.30-0.50	1.50-7.00	
			270408																							0.15-0.25	3.00-8.00	
270608																							0.15-0.25	3.00-8.00				

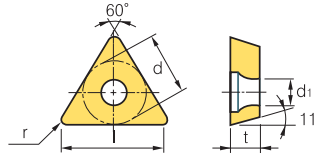
➤ Cutting edge geometry A37~A49
➤ Recommended chip breaker B04~B15
➤ Code system B34~B35
● : Stock item

Available tool holders			
Designation	Page	Designation	Page
STFPR/L	B221	STUPR/L	B226
CTFPR/L	B182	CTGPR/L	B182



TP

Triangular 60° Positive
Relief Angle: 11°



Dimensions (mm)			
Size	d	t	d _i
08	4.76	2.38	2.3
09	5.56	2.38	3.0
11	6.35	3.18	3.4
16	9.525	3.18~4.76	4.4

Workpiece	Machining types															
	P	M	K	N	S	H	●	●	●	●	●	●	●	●	●	●
Steel	●	●	●	●	●	●	●	●	●	●	●	●	●	●	●	●
Stainless steel	●	●	●	●	●	●	●	●	●	●	●	●	●	●	●	●
Cast iron	●	●	●	●	●	●	●	●	●	●	●	●	●	●	●	●
Non-ferrous metal	●	●	●	●	●	●	●	●	●	●	●	●	●	●	●	●
Heat resistant alloy, Titanium alloy	●	●	●	●	●	●	●	●	●	●	●	●	●	●	●	●
Hardened steel	●	●	●	●	●	●	●	●	●	●	●	●	●	●	●	●

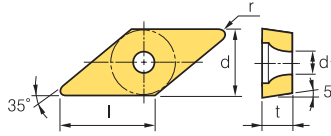
Inserts	Designation	Cermet		Coated														Uncoated		Cutting Condition							
		CN1500	CN2500	CC1500	CC2500	NC3215	NC3225	NC3120	NC3030	NC3235	NC5330	NC6310	NC6315	NC9115	NC9125	NC9135	PC5300	PC5400	PC8105	PC8110	PC8115	PC9030	H01	H05	f _n (mm/rev)	a _p (mm)	
Finishing		TPGH 080202L																								0.01~0.12	0.06~1.70
		080204L	●																							0.01~0.15	0.08~1.70
		110202L																								0.01~0.12	0.06~2.00
		110204L																								0.01~0.15	0.08~2.00
Medium to finishing		TPGT 080202R																							0.05~0.20	0.30~1.50	
		110302R																							0.05~0.20	0.30~1.50	
		110304R																							0.05~0.20	0.50~2.00	
		110308R																							0.07~0.25	0.50~2.00	
		160404R																							0.05~0.20	0.70~3.00	
		160408R																							0.05~0.20	0.70~3.00	
		080202L																					●	●	0.05~0.20	0.30~1.50	
		110302L																							0.05~0.20	0.30~1.50	
		110304L	●																						0.05~0.20	0.50~2.00	
		110308L																							0.07~0.25	0.50~2.00	
		160404L																							0.05~0.20	0.70~3.00	
160408L																							0.05~0.20	0.70~3.00			
Medium to finishing		TPGX 090202L																						0.10~0.20	0.30~1.00		
		090204L	●																					0.10~0.25	0.50~1.00		
		090208L																						0.10~0.30	1.00~1.00		
		110304L																						0.10~0.25	0.50~1.20		

Cutting edge geometry **A37~A49**
 Recommended chip breaker **B04~B15**
 Code system **B34~B35**
 ● : Stock item

Available tool holders			
Designation	Page	Designation	Page
STFPR/L	B221	STUPR/L	B226
CTFPR/L	B182	CTGPR/L	B182

B Turning Insert (Positive)

VB



Dimensions (mm)			
Size	d	t	d ₁
11	6.35	3.18	2.8
16	9.525	4.76	4.4

Rhombic **35° Positive**
Relief Angle: 5°

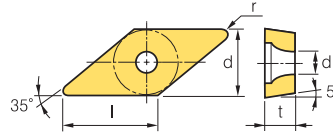
Workpiece	Machining types															
	P	M	K	N	S	H	●	⊙	⊚	⊛	⊜	⊝	⊞	⊟	⊠	⊡
Steel	●	⊙	⊚	⊛	⊜	⊝	⊞	⊟	⊠	⊡	⊢	⊣	⊤	⊥	⊦	⊧
Stainless steel	●	⊙	⊚	⊛	⊜	⊝	⊞	⊟	⊠	⊡	⊢	⊣	⊤	⊥	⊦	⊧
Cast iron	●	⊙	⊚	⊛	⊜	⊝	⊞	⊟	⊠	⊡	⊢	⊣	⊤	⊥	⊦	⊧
Non-ferrous metal	●	⊙	⊚	⊛	⊜	⊝	⊞	⊟	⊠	⊡	⊢	⊣	⊤	⊥	⊦	⊧
Heat resistant alloy, Titanium alloy	●	⊙	⊚	⊛	⊜	⊝	⊞	⊟	⊠	⊡	⊢	⊣	⊤	⊥	⊦	⊧
Hardened steel	●	⊙	⊚	⊛	⊜	⊝	⊞	⊟	⊠	⊡	⊢	⊣	⊤	⊥	⊦	⊧

Inserts	Designation	Cermet		Coated		Coated													Uncoated		Cutting Condition						
		CN1500	CN2500	CC1500	CC2500	NC3215	NC3225	NC3120	NC3030	NC3235	NC5330	NC6310	NC6315	NC9115	NC9125	NC9135	PC5300	PC5400	PC8105	PC8110	PC8115	PC9030	H01	H05	f _n (mm/rev)	a _p (mm)	
Finishing [Mild steel]	VBMT 110302-FP					●																			0.01~0.10	0.05~0.08	
	110304-FP		●			●																				0.01~0.10	0.10~0.90
	110308-FP		●			●																				0.01~0.10	0.10~1.00
	160404-FP	●	●	●	●	●	●							●							●					0.01~0.10	0.10~1.00
	160408-FP	●	●	●	●	●	●							●							●					0.04~0.12	0.10~1.00
Finishing 	VBMT 110302-VB																								0.05~0.15	0.20~1.20	
	110304-VB																									0.06~0.18	0.20~1.20
	110308-VB																									0.08~0.20	0.60~1.20
	160402-VB																									0.06~0.20	0.05~1.00
	160404-VB	●	●				●																			0.08~0.20	0.20~1.50
	160408-VB	●	●				●																			0.10~0.23	0.50~1.50
Finishing 	VBMT 160404-VF	●	●				●			●						●				●					0.05~0.20	0.30~1.00	
	160408-VF	●	●													●									0.10~0.25	0.30~1.00	
Finishing 	VBMT 110302-VL																								0.03~0.20	0.20~1.20	
	110304-VL																									0.04~0.20	0.20~1.20
	110308-VL																									0.08~0.20	0.20~1.20
	160402-VL																									0.03~0.20	0.30~1.50
	160404-VL	●	●	●	●	●	●				●			●	●	●	●	●	●	●	●	●				0.05~0.20	0.30~1.50
	160408-VL	●	●	●	●	●	●				●			●	●	●	●	●	●	●	●	●				0.10~0.20	0.30~1.50
Medium to finishing 	VBMT 110304-HMP							●														●			0.03~0.20	0.15~2.70	
	110308-HMP							●																		0.05~0.25	0.40~2.70
	160404-HMP							●	●		●					●				●		●				0.07~0.20	0.20~2.70
	160408-HMP							●	●	●		●				●				●		●				0.09~0.27	0.50~2.70
Medium to finishing 	VBMT 110302-MP																								0.04~0.14	0.20~1.50	
	110304-MP						●	●						●	●											0.05~0.15	0.20~1.50
	110308-MP						●	●																		0.10~0.28	0.30~2.00
	160402-MP																									0.06~0.16	0.25~2.00
	160404-MP	●	●	●	●	●	●				●	●		●	●	●	●	●	●	●	●	●				0.08~0.20	0.30~2.00
	160408-MP	●	●	●	●	●	●				●	●		●	●	●	●	●	●	●	●	●				0.10~0.25	0.50~2.30
	160412-MP	●	●			●	●				●			●	●	●	●	●	●	●	●	●				0.10~0.35	0.50~2.30

Cutting edge geometry A37~A49
 Recommended chip breaker B04~B15
 Code system B34~B35
 ● : Stock item

Available tool holders			
Designation	Page	Designation	Page
SVABR/L	B195	SVVBN	B196
SVHBR/L	B195	SVQBR/L	B222
SVJBR/L	B125, 195	SVUBR/L	B223





Dimensions (mm)			
Size	d	t	d ₁
11	6.35	2.38~3.18	2.8~3.4
16	9.525	4.76	4.4

Rhombic **35° Positive** Relief Angle: 5°

Workpiece	Material												Machining types			
	Steel	Stainless steel	Cast iron	Non-ferrous metal	Heat resistant alloy, Titanium alloy	Hardened steel	P	M	K	N	S	H	Continuous cutting	General cutting	Interrupted cutting	
Steel	●	●	●	●	●	●	●	●	●	●	●	●	●	●	●	●
Stainless steel	●	●	●	●	●	●	●	●	●	●	●	●	●	●	●	●
Cast iron	●	●	●	●	●	●	●	●	●	●	●	●	●	●	●	●
Non-ferrous metal	●	●	●	●	●	●	●	●	●	●	●	●	●	●	●	●
Heat resistant alloy, Titanium alloy	●	●	●	●	●	●	●	●	●	●	●	●	●	●	●	●
Hardened steel	●	●	●	●	●	●	●	●	●	●	●	●	●	●	●	●

Inserts	Designation	Cermet		Coated		Coated										Uncoated		Cutting Condition										
		CN1500	CN2500	CC1500	CC2500	NC3215	NC3225	NC3120	NC3030	NC3235	NC5330	NC6310	NC6315	NC9115	NC9125	NC9135	PC5300	PC5400	PC8105	PC8110	PC8115	PC9030	H01	H05	f _n (mm/rev)	a _p (mm)		
Medium to finishing		VBMT 160404	●	●	●	●	●	●	●	●	●	●	●	●	●	●	●	●	●	●	●	●	●	●	0.07~0.20	0.50~1.50		
			160408	●	●	●	●	●	●	●	●	●	●	●	●	●	●	●	●	●	●	●	●	●	●	0.15~0.25	0.70~2.00	
Medium to finishing		VBGT 160404	●	●	●	●	●	●	●	●	●	●	●	●	●	●	●	●	●	●	●	●	●	●	0.07~0.20	0.50~1.50		
			160408	●	●	●	●	●	●	●	●	●	●	●	●	●	●	●	●	●	●	●	●	●	●	0.15~0.25	0.70~2.00	
Finishing		VBMT 160402-VP1	●	●	●	●	●	●	●	●	●	●	●	●	●	●	●	●	●	●	●	●	●	●	0.04~0.20	0.16~1.50		
			160404-VP1	●	●	●	●	●	●	●	●	●	●	●	●	●	●	●	●	●	●	●	●	●	●	0.05~0.20	0.18~1.80	
			160408-VP1	●	●	●	●	●	●	●	●	●	●	●	●	●	●	●	●	●	●	●	●	●	●	0.06~0.20	0.20~1.80	
Finishing		VBGT 110301-FS	●	●	●	●	●	●	●	●	●	●	●	●	●	●	●	●	●	●	●	●	●	●	0.01~0.16	0.03~1.40		
			110302-FS	●	●	●	●	●	●	●	●	●	●	●	●	●	●	●	●	●	●	●	●	●	●	0.02~0.18	0.04~1.50	
			110304-FS	●	●	●	●	●	●	●	●	●	●	●	●	●	●	●	●	●	●	●	●	●	●	0.04~0.19	0.06~1.60	
			160401-FS	●	●	●	●	●	●	●	●	●	●	●	●	●	●	●	●	●	●	●	●	●	●	●	0.01~0.16	0.04~1.80
			160402-FS	●	●	●	●	●	●	●	●	●	●	●	●	●	●	●	●	●	●	●	●	●	●	●	0.02~0.18	0.05~2.00
			160404-FS	●	●	●	●	●	●	●	●	●	●	●	●	●	●	●	●	●	●	●	●	●	●	●	0.04~0.19	0.08~2.00
Finishing		VBGT 110301MFN-FS	●	●	●	●	●	●	●	●	●	●	●	●	●	●	●	●	●	●	●	●	●	●	0.01~0.16	0.03~1.40		
			110302MFN-FS	●	●	●	●	●	●	●	●	●	●	●	●	●	●	●	●	●	●	●	●	●	●	0.02~0.18	0.04~1.50	
			110304MFN-FS	●	●	●	●	●	●	●	●	●	●	●	●	●	●	●	●	●	●	●	●	●	●	0.04~0.19	0.06~1.60	
			160401MFN-FS	●	●	●	●	●	●	●	●	●	●	●	●	●	●	●	●	●	●	●	●	●	●	0.01~0.16	0.04~1.80	
			160402MFN-FS	●	●	●	●	●	●	●	●	●	●	●	●	●	●	●	●	●	●	●	●	●	●	0.02~0.18	0.05~2.00	
			160404MFN-FS	●	●	●	●	●	●	●	●	●	●	●	●	●	●	●	●	●	●	●	●	●	●	0.04~0.19	0.08~2.00	
Finishing		VBGT 110302-VP1	●	●	●	●	●	●	●	●	●	●	●	●	●	●	●	●	●	●	●	●	●	●	0.03~0.10	0.08~1.50		
			160402-VP1	●	●	●	●	●	●	●	●	●	●	●	●	●	●	●	●	●	●	●	●	●	0.04~0.20	0.16~1.50		
			160404-VP1	●	●	●	●	●	●	●	●	●	●	●	●	●	●	●	●	●	●	●	●	●	0.05~0.20	0.18~1.80		

Cutting edge geometry **A37~A49**
 Recommended chip breaker **B04~B15**
 Code system **B34~B35**
 ● : Stock item

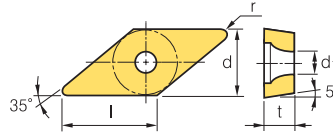
Available tool holders			
Designation	Page	Designation	Page
SVABR/L	B195	SVVBN	B196
SVHBR/L	B195	SVQBR/L	B222
SVJBR/L	B125, 195	SVUBR/L	B223



B Turning Insert (Positive)



VB ○○

 Rhombic **35° Positive**
Relief Angle: 5°



Dimensions (mm)			
Size	d	t	d ₁
11	6.35	3.18	2.8

Workpiece	Material Compatibility													Machining types				
	Steel	Stainless steel	Cast iron	Non-ferrous metal	Heat resistant alloy, Titanium alloy	Hardened steel	P	M	K	N	S	H	●	⦿	✱	●	⦿	
Steel							●	✱	●	⦿	●	●	●	●	●	●	●	●
Stainless steel		●																
Cast iron			●															
Non-ferrous metal				●														
Heat resistant alloy, Titanium alloy					●													
Hardened steel						●												

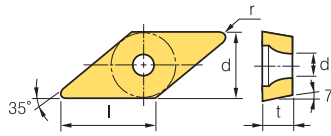
Inserts	Designation	Cermet		Coated		Coated										Uncoated		Cutting Condition									
		CN1500	CN2500	CC1500	CC2500	NC3215	NC3225	NC3120	NC3030	NC3235	NC5330	NC6310	NC6315	NC9115	NC9125	NC9135	PC5300	PC5400	PC8105	PC8110	PC8115	PC9030	H01	H05	f _n (mm/rev)	a _p (mm)	
Finishing  [High precision]	VBGT 1103003R-KF																									0.01-0.06	0.04-1.30
	110301R-KF																									0.02-0.08	0.05-1.50
	110302R-KF																									0.03-0.13	0.06-1.70
	1103003L-KF																									0.01-0.06	0.04-1.30
	110301L-KF																									0.02-0.08	0.05-1.50
	110302L-KF																									0.03-0.13	0.06-1.70
Medium to finishing  [High precision]	VBGT 1103003R-KM																									0.01-0.06	0.04-1.30
	110301R-KM																									0.02-0.08	0.05-1.50
	110302R-KM																									0.03-0.13	0.06-1.70
	1103003L-KM																									0.01-0.06	0.04-1.30
	110301L-KM																									0.02-0.08	0.05-1.50
	110302L-KM																									0.03-0.13	0.06-1.70

 Cutting edge geometry **A37~A49**
  Recommended chip breaker **B04~B15**
  Code system **B34~B35**
 ● : Stock item

Available tool holders			
Designation	Page	Designation	Page
SVABR/L	B195	SVVBN	B196
SVHBR/L	B195	SVQBR/L	B222
SVJBR/L	B125, 195	SVUBR/L	B223



VC



Dimensions (mm)			
Size	d	t	d ₁
08	4.76	2.38	2.3
11	6.35	3.18	2.8~3.4
16	9.525	4.76	4.4

Rhombic 35° Positive
Relief Angle: 5°

Workpiece	Material		Cutting Conditions																Machining types		
	Symbol	Color	1	2	3	4	5	6	7	8	9	10	11	12	13	14	15	16	Continuous cutting	General cutting	Interrupted cutting
Steel	P	Blue	●	*	●	●	●	●	●	●	●	●	●	●	●	●	●	●	●	●	●
Stainless steel	M	Yellow	●	*	●	●	●	●	●	●	●	●	●	●	●	●	●	●	●	●	●
Cast iron	K	Red	●	*	●	●	●	●	●	●	●	●	●	●	●	●	●	●	●	●	●
Non-ferrous metal	N	Green																	●	●	●
Heat resistant alloy, Titanium alloy	S	Orange																	●	●	●
Hardened steel	H	Grey																	●	●	●

Inserts	Designation	Cermets		Coated		Coated											Uncoated		Cutting Condition									
		CN1500	CN2500	CC1500	CC2500	NC3215	NC3225	NC3120	NC3030	NC3235	NC5330	NC6310	NC6315	NC9115	NC9125	NC9135	PC5300	PC5400	PC8105	PC8110	PC8115	PC9030	H01	H05	f _n (mm/rev)	a _p (mm)		
Finishing FP [Mild steel]	VCMT 080202-FP					●																				0.01~0.10	0.05~0.08	
	VCMT 080204-FP					●	●																				0.01~0.10	0.10~0.90
	VCMT 080408-FP					●	●																				0.04~1.00	0.10~1.00
	VCMT 160404-FP																										0.01~0.10	0.10~1.00
	VCMT 160408-FP					●	●	●	●														●				0.04~0.12	0.10~1.00
Finishing VF	VCMT 080202-VF																									0.05~0.20	0.30~1.00	
	VCMT 080204-VF																									0.10~0.25	0.30~1.00	
	VCMT 110304-VF							●																		0.03~0.18	0.15~1.20	
	VCMT 160404-VF							●																		0.04~0.20	0.15~1.50	
Finishing VL	VCMT 080202-VL					●	●																			0.03~0.08	0.10~0.80	
	VCMT 080204-VL					●	●																			0.04~0.10	0.10~0.90	
	VCMT 160404-VL					●	●																			0.05~0.20	0.30~1.50	
	VCMT 160408-VL					●	●																			0.05~0.20	0.30~1.50	
	VCMT 160412-VL																									0.10~0.25	0.30~1.50	
Medium to finishing HMP	VCMT 160404-HMP								●	●																0.10~0.25	0.30~2.60	
	VCMT 160408-HMP								●	●																0.13~0.33	0.60~2.60	
Medium to finishing MP	VCMT 080202-MP					●	●																			0.03~0.15	0.10~1.00	
	VCMT 080204-MP					●	●																			0.05~0.18	0.10~1.00	
	VCMT 110302-MP																									0.06~0.18	0.20~1.80	
	VCMT 110304-MP																									0.06~0.18	0.20~1.80	
	VCMT 160404-MP					●	●							●	●	●	●									0.08~0.18	0.30~2.00	
	VCMT 160408-MP					●	●																			0.10~0.23	0.50~2.30	
Finishing VP1	VCMT 160404-VP1																									0.05~0.20	0.18~1.80	
	VCMT 160408-VP1																									0.06~0.20	0.20~1.80	

Cutting edge geometry A37~A49
 Recommended chip breaker B04~B15
 Code system B34~B35
 ● : Stock item

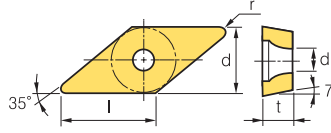
Available tool holders			
Designation	Page	Designation	Page
SVJCR/L	B125, 196, 222	SVQCR/L	B223
SVVCN	B196	SVUCR/L	B223



B Turning Insert (Positive)

VC

Rhombic **35° Positive**
Relief Angle: 7°



Dimensions (mm)			
Size	d	t	d ₁
11	6.35	3.18	2.8~3.4
12	7.5	3.18	2.8
16	9.525	4.76	4.4

Workpiece	Material Compatibility													Machining types				
	Steel	Stainless steel	Cast iron	Non-ferrous metal	Heat resistant alloy, Titanium alloy	Hardened steel	P	M	K	N	S	H	●	●	●	●	●	●
Steel	●	●	●	●	●	●	●	●	●	●	●	●	●	●	●	●	●	●
Stainless steel	●	●	●	●	●	●	●	●	●	●	●	●	●	●	●	●	●	●
Cast iron	●	●	●	●	●	●	●	●	●	●	●	●	●	●	●	●	●	●
Non-ferrous metal	●	●	●	●	●	●	●	●	●	●	●	●	●	●	●	●	●	●
Heat resistant alloy, Titanium alloy	●	●	●	●	●	●	●	●	●	●	●	●	●	●	●	●	●	●
Hardened steel	●	●	●	●	●	●	●	●	●	●	●	●	●	●	●	●	●	●

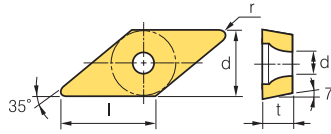
Inserts	Designation	Cermet		Coated		Coated										Uncoated		Cutting Condition										
		CN1500	CN2500	CC1500	CC2500	NC3215	NC3225	NC3120	NC3030	NC3235	NC5330	NC6310	NC6315	NC9115	NC9125	NC9135	PC5300	PC5400	PC8105	PC8110	PC8115	PC9030	H01	H05	f _n (mm/rev)	a _p (mm)		
Finishing [High precision]	VCGT	110301-FS	●	●	●	●	●	●	●	●	●	●	●	●	●	●	●	●	●	●	●	●	●	●	●	0.01~0.16	0.03~1.40	
		110302-FS	●	●	●	●	●	●	●	●	●	●	●	●	●	●	●	●	●	●	●	●	●	●	●	●	0.02~0.18	0.04~1.50
		110304-FS	●	●	●	●	●	●	●	●	●	●	●	●	●	●	●	●	●	●	●	●	●	●	●	●	0.04~0.19	0.06~1.60
		160401-FS	●	●	●	●	●	●	●	●	●	●	●	●	●	●	●	●	●	●	●	●	●	●	●	●	0.01~0.16	0.04~1.80
		160402-FS	●	●	●	●	●	●	●	●	●	●	●	●	●	●	●	●	●	●	●	●	●	●	●	●	0.02~0.18	0.05~2.00
		160404-FS	●	●	●	●	●	●	●	●	●	●	●	●	●	●	●	●	●	●	●	●	●	●	●	●	0.04~0.19	0.08~2.00
Finishing [Ultra high precision]	VCGT	110301MFN-FS	●	●	●	●	●	●	●	●	●	●	●	●	●	●	●	●	●	●	●	●	●	●	●	0.01~0.16	0.03~1.40	
		110302MFN-FS	●	●	●	●	●	●	●	●	●	●	●	●	●	●	●	●	●	●	●	●	●	●	●	0.02~0.18	0.04~1.50	
		110304MFN-FS	●	●	●	●	●	●	●	●	●	●	●	●	●	●	●	●	●	●	●	●	●	●	●	0.04~0.19	0.06~1.60	
		160401MFN-FS	●	●	●	●	●	●	●	●	●	●	●	●	●	●	●	●	●	●	●	●	●	●	●	●	0.01~0.16	0.04~1.80
		160402MFN-FS	●	●	●	●	●	●	●	●	●	●	●	●	●	●	●	●	●	●	●	●	●	●	●	●	0.02~0.18	0.05~2.00
		160404MFN-FS	●	●	●	●	●	●	●	●	●	●	●	●	●	●	●	●	●	●	●	●	●	●	●	●	0.04~0.19	0.08~2.00
Medium cutting [High precision]	VCGT	110301-MS	●	●	●	●	●	●	●	●	●	●	●	●	●	●	●	●	●	●	●	●	●	●	●	0.02~0.23	0.05~2.00	
		110302-MS	●	●	●	●	●	●	●	●	●	●	●	●	●	●	●	●	●	●	●	●	●	●	●	0.03~0.25	0.07~2.50	
		110304-MS	●	●	●	●	●	●	●	●	●	●	●	●	●	●	●	●	●	●	●	●	●	●	●	0.05~0.25	0.09~2.50	
Medium cutting [Ultra high precision]	VCGT	110301MFN-MS	●	●	●	●	●	●	●	●	●	●	●	●	●	●	●	●	●	●	●	●	●	●	●	0.02~0.23	0.05~2.00	
		110302MFN-MS	●	●	●	●	●	●	●	●	●	●	●	●	●	●	●	●	●	●	●	●	●	●	●	0.03~0.25	0.07~2.50	
		110304MFN-MS	●	●	●	●	●	●	●	●	●	●	●	●	●	●	●	●	●	●	●	●	●	●	●	0.05~0.25	0.09~2.50	
Medium cutting [Ultra high precision]	VCGT	1203008FN-MS	●	●	●	●	●	●	●	●	●	●	●	●	●	●	●	●	●	●	●	●	●	●	●	0.02~0.20	0.04~1.80	
		120301FN-MS	●	●	●	●	●	●	●	●	●	●	●	●	●	●	●	●	●	●	●	●	●	●	●	0.03~0.26	0.06~2.20	
		120302FN-MS	●	●	●	●	●	●	●	●	●	●	●	●	●	●	●	●	●	●	●	●	●	●	●	0.05~0.28	0.08~2.80	
		120304FN-MS	●	●	●	●	●	●	●	●	●	●	●	●	●	●	●	●	●	●	●	●	●	●	●	0.06~0.30	0.10~2.80	
Finishing [High precision]	VCGT	110301-VP1	●	●	●	●	●	●	●	●	●	●	●	●	●	●	●	●	●	●	●	●	●	●	●	0.02~0.15	0.05~0.50	
		110302-VP1	●	●	●	●	●	●	●	●	●	●	●	●	●	●	●	●	●	●	●	●	●	●	●	0.02~0.18	0.10~1.00	
		110304-VP1	●	●	●	●	●	●	●	●	●	●	●	●	●	●	●	●	●	●	●	●	●	●	●	0.03~0.18	0.15~1.20	
		160404-VP1	●	●	●	●	●	●	●	●	●	●	●	●	●	●	●	●	●	●	●	●	●	●	●	●	0.05~0.20	0.18~1.80
		160408-VP1	●	●	●	●	●	●	●	●	●	●	●	●	●	●	●	●	●	●	●	●	●	●	●	●	0.06~0.20	0.20~1.80

Cutting edge geometry **A37~A49**
 Recommended chip breaker **B04~B15**
 Code system **B34~B35**
● : Stock item

Available tool holders			
Designation	Page	Designation	Page
SVJCR/L	B125, 196, 222	SVQCR/L	B223
SVVCN	B196	SVUCR/L	B223



VC



Dimensions (mm)			
Size	d	t	d ₁
11	6.35	3.18	2.8~3.4
12	7.5	3.18	2.8

Rhombic 35° Positive
Relief Angle: 7°

Workpiece	Material												Machining types				
	Steel	Stainless steel	Cast iron	Non-ferrous metal	Heat resistant alloy, Titanium alloy	Hardened steel	P	M	K	N	S	H	●	⊙	⊛	⊞	
Steel							●	⊙	⊛	⊞			●	⊙	⊛	⊞	● Continuous cutting ⊙ General cutting ⊛ Interrupted cutting
Stainless steel																	
Cast iron																	
Non-ferrous metal																	
Heat resistant alloy, Titanium alloy																	
Hardened steel																	

Inserts	Designation	Cermet		Coated		Coated										Uncoated		Cutting Condition										
		CN1500	CN2500	CC1500	CC2500	NC3215	NC3225	NC3120	NC3030	NC3235	NC5330	NC6310	NC6315	NC9115	NC9125	NC9135	PC5300	PC5400	PC8105	PC8110	PC8115	PC9030	H01	H05	f _n (mm/rev)	a _p (mm)		
Finishing [Ultra high precision]	VCGT	110301MFN-VP1														●				●						0.02~0.15	0.05~0.50	
		110302MFN-VP1															●				●						0.02~0.18	0.10~1.00
		110304MFN-VP1															●				●						0.03~0.18	0.15~1.20
		1203008FN-VP1																									0.03~0.12	0.06~1.20
		120301FN-VP1																									0.04~0.13	0.08~1.20
		120302FN-VP1																									0.04~0.15	0.08~1.20
		120304FN-VP1																									0.06~0.20	0.10~1.50
Finishing [Ultra high precision]	VCGX	120300MFR-VP1														●				●						0.02~0.10	0.05~0.50	
		120301MFR-VP1															●				●					0.02~0.15	0.05~0.50	
		120302MFR-VP1															●				●					0.02~0.18	0.10~1.00	
		120304MFR-VP1															●				●					0.03~0.20	0.12~1.20	
		120308MFR-VP1															●				●					0.05~0.20	0.15~1.20	
Finishing [High precision]	VCGT	1103003R-KF																								0.01~0.06	0.04~1.30	
		110301R-KF																								0.02~0.08	0.05~1.50	
		110302R-KF																					●			0.03~0.13	0.06~1.70	
		1103003L-KF																								0.01~0.06	0.04~1.30	
		110301L-KF																								0.02~0.08	0.05~1.50	
		110302L-KF																								0.03~0.13	0.06~1.70	
Finishing [Ultra high precision]	VCET	1103005MFR-KF														●				●					0.01~0.06	0.04~1.30		
		110301MFR-KF															●				●				0.02~0.08	0.05~1.50		
		110302MFR-KF															●				●				0.03~0.11	0.06~1.70		
		1103005MFL-KF															●				●				0.01~0.06	0.04~1.30		
		110301MFL-KF															●				●				0.02~0.08	0.05~1.50		
		110302MFL-KF															●				●				0.03~0.11	0.06~1.70		
Finishing [High precision]	VCGT	1103003R-KM																								0.01~0.06	0.04~1.30	
		110301R-KM																								0.02~0.08	0.05~1.50	
		110302R-KM																					●			0.03~0.13	0.06~1.70	
		1103003L-KM																								0.01~0.06	0.04~1.30	
		110301L-KM																								0.02~0.08	0.05~1.50	
		110302L-KM																								0.03~0.13	0.06~1.70	
Medium to finishing [Ultra high precision]	VCET	1103005MFR-KM														●				●					0.02~0.08	0.05~1.50		
		110301MFR-KM															●				●				0.03~0.11	0.06~1.70		
		110302MFR-KM															●				●				0.04~0.15	0.08~2.00		
		1103005MFL-KM															●				●				0.02~0.08	0.05~1.50		
		110301MFL-KM															●				●				0.03~0.11	0.06~1.70		
		110302MFL-KM															●				●				0.04~0.15	0.08~2.00		

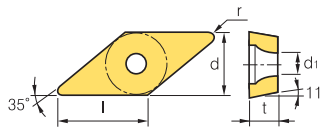
➡ Cutting edge geometry A37~A49
➡ Recommended chip breaker B04~B15
➡ Code system B34~B35
● : Stock item

Available tool holders			
Designation	Page	Designation	Page
SVJCR/L	B125, 196, 222	SVQCR/L	B223
SVVCN	B196	SVUCR/L	B223



B Turning Insert (Positive)





VP





Dimensions (mm)			
Size	d	t	d ₁
08	6.35	2.38	2.3
11	6.35	3.18	2.8

 Rhombic **35° Positive**
Relief Angle: 11°

Workpiece	Machining types												
	P	M	K	N	S	H							
Steel	●	●	●	●	●	●	●	●	●	●	●	●	●
Stainless steel	●	●	●	●	●	●	●	●	●	●	●	●	●
Cast iron	●	●	●	●	●	●	●	●	●	●	●	●	●
Non-ferrous metal	●	●	●	●	●	●	●	●	●	●	●	●	●
Heat resistant alloy, Titanium alloy	●	●	●	●	●	●	●	●	●	●	●	●	●
Hardened steel	●	●	●	●	●	●	●	●	●	●	●	●	●

Inserts	Designation	Cermet		Coated										Uncoated		Cutting Condition												
		CN1500	CN2500	CC1500	CC2500	NC3215	NC3225	NC3120	NC3030	NC3235	NC5330	NC6310	NC6315	NC9115	NC9125	NC9135	PC5300	PC5400	PC8105	PC8110	PC8115	PC9030	H01	H05	f _n (mm/rev)	a _p (mm)		
Finishing  [High precision]	VPGT	110301-VP1														●		●	●	●					0.02~0.15	0.05~0.50		
		110302-VP1															●		●	●	●					0.02~0.18	0.10~1.00	
		110304-VP1															●		●	●	●					0.03~0.18	0.15~1.20	
Finishing  [Ultra high precision]	VPGT	110301MFN-VP1														●		●								0.02~0.15	0.05~0.50	
		110302MFN-VP1															●		●								0.02~0.18	0.10~1.00
		110304MFN-VP1															●		●								0.03~0.18	0.15~1.20
Finishing  [Ultra high precision]	VPET	0802005MFR-KF														●		●								0.01~0.12	0.05~0.50	
		080201MFR-KF															●		●								0.02~0.15	0.05~0.50
		080202MFR-KF															●		●								0.02~0.18	0.10~1.00
		0802005MFL-KF															●		●								0.01~0.12	0.05~0.50
		080201MFL-KF															●		●								0.02~0.15	0.05~0.50
		080202MFL-KF															●		●								0.02~0.18	0.10~1.00
Medium to finishing  [Ultra high precision]	VPET	0802005MFR-KM														●		●								0.01~0.12	0.05~0.50	
		080201MFR-KM															●		●								0.02~0.15	0.05~0.50
		080202MFR-KM															●		●								0.02~0.18	0.10~1.00
		0802005MFL-KM															●		●								0.01~0.12	0.05~0.50
		080201MFL-KM															●		●								0.02~0.15	0.05~0.50
		080202MFL-KM															●		●								0.02~0.18	0.10~1.00

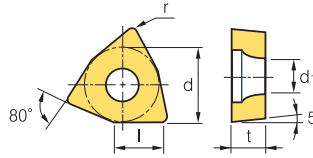
 Cutting edge geometry A37~A49
  Recommended chip breaker B04~B15
  Code system B34~B35
 ● : Stock item

Available tool holders			
Designation	Page	Designation	Page
SVABR/L	B195	SVVBN	B196
SVJBR/L	B125, 195		



WB

Dimensions (mm)			
Size	d	t	d ₁
02	3.97	1.59	2.2
S3	4.76	2.38	2.4



Trigon 80° Positive
Relief Angle: 5°

Workpiece	Machining types															
	P	M	K	N	S	H	1	2	3	4	5	6	7	8	9	10
Steel	●	●	●	●	●	●	●	●	●	●	●	●	●	●	●	●
Stainless steel	●	●	●	●	●	●	●	●	●	●	●	●	●	●	●	●
Cast iron	●	●	●	●	●	●	●	●	●	●	●	●	●	●	●	●
Non-ferrous metal	●	●	●	●	●	●	●	●	●	●	●	●	●	●	●	●
Heat resistant alloy, Titanium alloy	●	●	●	●	●	●	●	●	●	●	●	●	●	●	●	●
Hardened steel	●	●	●	●	●	●	●	●	●	●	●	●	●	●	●	●

Inserts	Designation	Cermet		Coated													Uncoated		Cutting Condition									
		CN1500	CN2500	CC1500	CC2500	NC3215	NC3225	NC3120	NC3030	NC3235	NC5330	NC6310	NC6315	NC9115	NC9125	NC9135	PC5300	PC5400	PC8105	PC8110	PC8115	PC9030	H01	H05	f _n (mm/rev)	a _p (mm)		
Medium to finishing	WBGT 020102R																									0.01~0.05	0.10~0.30	
	S30204R																										0.01~0.10	0.10~0.50
	020102L																					●	●			0.01~0.08	0.10~0.40	
	S30202L																										0.01~0.08	0.10~0.40
	S30204L																										0.01~0.10	0.10~0.50

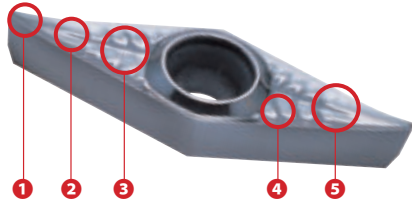
➡ Cutting edge geometry **A37~A49**
 ➡ Recommended chip breaker **B04~B15**
 ➡ Code system **B34~B35**
 ● : Stock item

Available tool holders	
Designation	Page
SWUBR/L	B227

Technical Information for Aluminum

AK special chip breaker for aluminum

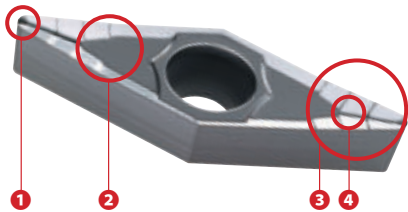
- Unique and 3-dimensional rake angle controls chip breaking and chip flow ensuring longer tool life and reducing cutting load
- High rake angle at cutting edge part reduces cutting load to increase tool life
- Buffed finish on top face controls chip flow reducing built-up edge



- 1 High rake angle & tabby pattern chip pocket - Low cutting load
- 2 Unique rake angle design - Effective chip breaking and good chip flow
- 3 Unique and 3-dimensional top face - Longer tool life & Excellent surface roughness
- 4 Tabby pattern & Sharp cutting edge - Distributing cutting load, long tool life
- 5 Buffed on top face - Excellent machining, Reducing built-up edge, Excellent chip flow

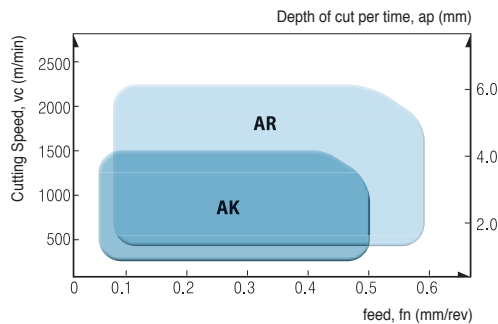
AR special chip breaker for aluminum

- AR chip breaker ensures reliability and good cutting performance at high feed, speed and interrupted machining

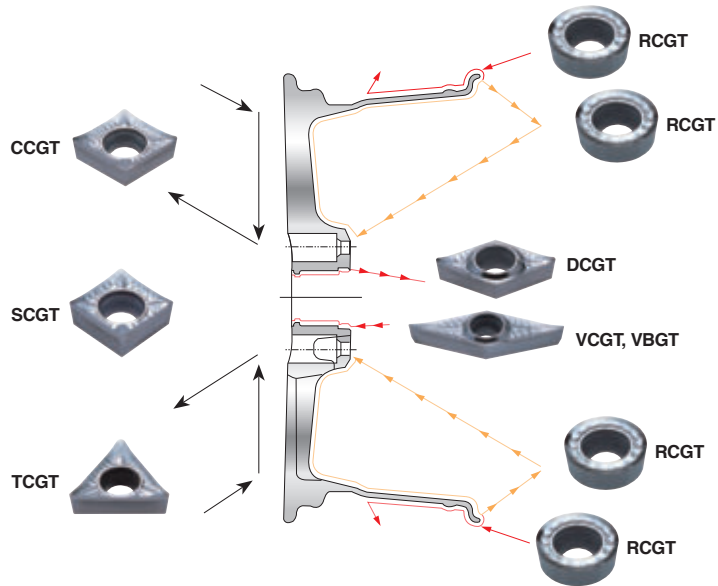


- 1 Flat corner cutting edge improved productivity at high feed machining and ensures good surface roughness and reliability owing to strong cutting edge
- 2 Specially buffed on top face controls chip flow reducing built-up edge
- 3 KORLOY's own technology applied for cutting edge and corner shape controlling chip flow ensures longer tool life
- 4 KORLOY special chip breaker design controls chip flow at high speed machining

AK and AR chip breaker specially developed for aluminum



	Recommendation range	Grades
AK	ap = 0.1~5.0 mm fn = 0.03~0.5 mm/rev	H01 (Uncoated cemented carbides K10~K20) ND1000 (Diamond coating) PD1000 (DLC coating)
AR	ap = 0.5~6.0 mm fn = 0.05~0.6 mm/rev	H01 (Uncoated cemented carbides K10~K20) ND1000 (Diamond coating) PD1000 (DLC coating)



Features of H01 and cutting conditions

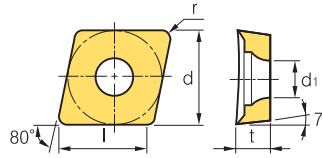
- Good for aluminum and alloy steel machining - Surface treatment reduces built-up edge
- 3-dimensional design reduces cutting resistance and ensures high machinability in high feed and speed machining

Workpiece		Hardness (HB)	kc (MPa)	vc (m/min)	fn (mm/rev)
Aluminum alloy (forged)	before heat treatment	50~70	500~600	1000~2500	0.1~0.6
	after heat treatment	90~110	700~900	300~1000	0.1~0.5
Aluminum alloy (cast)	before heat treatment	70~80	700~800	300~1000	0.1~0.6
	after heat treatment	80~100	800~950	200~600	0.1~0.4
Copper alloy	—	90~110	700	250~600	0.1~0.5
Non-ferrous metal, etc.	—	100	1700	150~300	0.1~0.6





Rhombic 80° Positive
Relief Angle: 7°



Dimensions (mm)			
Size	d	t	d ₁
06	6.35	2.38	2.8
09	9.525	3.97	4.4
12	12.7	4.76	5.5

Workpiece	Steel	P						Machining types	
	Stainless steel	M							● Continuous cutting
Cast iron	K							● General cutting	
Non-ferrous metal	N	✱	●	✱	●	✱		✱ Interrupted cutting	
Heat resistant alloy, Titanium alloy	S								
Hardened steel	H								

Inserts	Designation	Coated			Uncoated		Cutting Condition	
		PC5040	PD1005	PD1010	H01	H05	fn (mm/rev)	ap (mm)
AK 	CCGT 060202-AK	●			●	●	0.01~0.12	0.05~3.00
	060204-AK	●		●	●	●	0.02~0.15	0.10~3.00
	060208-AK				●	●	0.02~0.20	0.10~4.00
	09T302-AK	●		●	●	●	0.02~0.20	0.05~3.00
	09T304-AK	●		●	●	●	0.02~0.30	0.10~5.00
	09T308-AK	●			●	●	0.03~0.50	0.10~5.00
	120402-AK				●	●	0.02~0.30	0.05~4.00
	120404-AK	●		●	●	●	0.03~0.50	0.10~5.00
	120408-AK				●	●	0.04~0.80	0.10~5.50
AR 	CCGT 060202-AR				●	●	0.02~0.30	0.30~4.00
	060204-AR						0.03~0.35	0.50~4.50
	060208-AR						0.04~0.50	0.50~4.50
	09T302-AR				●	●	0.03~0.45	0.30~4.00
	09T304-AR				●	●	0.04~0.50	0.50~4.50
	09T308-AR				●	●	0.05~0.60	0.50~6.00
	120402-AR						0.04~0.50	0.30~5.00
	120404-AR				●	●	0.05~0.60	0.50~6.00
	120408-AR				●	●	0.06~0.65	0.50~6.00
	120412-AR						0.08~0.70	0.50~6.50

Cutting edge geometry **A37~A49**
 Recommended chip breaker **B04~B15**
 Code system **B34~B35**
● : Stock item

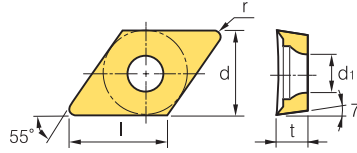
Available tool holders			
Designation	Page	Designation	Page
SCACR/L	B123, 190	SCLCR/L	B123, 190, 215



B Aluminum Insert (Positive)



DC

 Rhombic **55° Positive**
Relief Angle: 7°



Dimensions (mm)			
Size	d	t	d ₁
07	6.35	2.38	2.8
11	9.525	3.97	4.4

Workpiece	Steel	P					Machining types
	Stainless steel	M					
Cast iron	K						● Continuous cutting
Non-ferrous metal	N	✱	●	✱	●	✱	● General cutting
Heat resistant alloy, Titanium alloy	S						✱ Interrupted cutting
Hardened steel	H						

Inserts	Designation	Coated			Uncoated		Cutting Condition	
		PC5040	PD1005	PD1010	H01	H05	f _n (mm/rev)	a _p (mm)
AK 	DCGT 070202-AK	●			●	●	0.01~0.20	0.05~3.00
	070204-AK	●		●	●	●	0.02~0.30	0.10~4.00
	070208-AK	●			●	●	0.03~0.40	0.10~4.00
	11T302-AK	●		●	●	●	0.02~0.30	0.05~4.00
	11T304-AK	●		●	●	●	0.03~0.50	0.10~5.00
	11T308-AK	●		●	●	●	0.03~0.50	0.10~5.00
	11T312-AK					●	●	0.04~0.60
AR 	DCGT 070202-AR				●	●	0.02~0.30	0.30~4.00
	070204-AR				●	●	0.03~0.40	0.50~5.00
	070208-AR				●	●	0.04~0.50	0.50~5.00
	11T302-AR						0.03~0.45	0.30~6.00
	11T304-AR				●	●	0.04~0.50	0.50~6.00
	11T308-AR				●	●	0.05~0.60	0.50~6.00
	11T312-AR				●	●	0.08~0.65	0.50~6.50

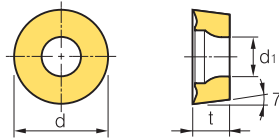
 Cutting edge geometry **A37~A49**
 Recommended chip breaker **B04~B15**
 Code system **B34~B35**
● : Stock item

Available tool holders			
Designation	Page	Designation	Page
SDACR/L	B190	SDQCR/L	B217
SDJCR/L	B123, 191	SDUCR/L	B218
SDNCN	B124, 191	SDZCR/L	B219



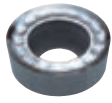

RC


 **Round Positive**
Relief Angle: 7°



Dimensions (mm)			
Size	d	t	d ₁
06	6.0	2.38	2.8
08	8.0	3.18	3.35
10	10.0	3.18~3.97	4.4
12	12.0	4.76	4.4

Workpiece	Steel	P					Machining types ● Continuous cutting ● General cutting ✦ Interrupted cutting
	Stainless steel	M					
	Cast iron	K					
	Non-ferrous metal	N	✦	●	✦	✦	
	Heat resistant alloy, Titanium alloy	S					
Hardened steel	H						

Inserts	Designation	Coated			Uncoated		Cutting Condition	
		PC5040	PD1005	PD1010	H01	H05	f _n (mm/rev)	a _p (mm)
AK 	RCGT 0602M0-AK				●	●	0.05~0.20	0.50~2.00
	0803M0-AK				●	●	0.05~0.25	0.50~2.50
	1003M0-AK				●	●	0.10~0.30	1.00~3.00
	1204M0-AK				●	●	0.10~0.35	1.00~3.50
AR 	RCGT 0602M0-AR						0.05~0.20	0.50~2.00
	0803M0-AR						0.05~0.25	0.50~2.50
	1003M0-AR				●	●	0.10~0.30	1.00~3.00
	10T3M0-AR						0.10~0.30	1.00~3.00
	1204M0-AR						0.10~0.35	1.00~3.50

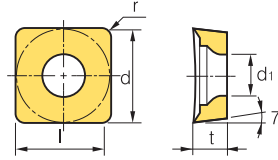
 Cutting edge geometry **A37~A49**
 Recommended chip breaker **B04~B15**
 Code system **B34~B35**
● : Stock item

Available tool holders			
Designation	Page	Designation	Page
SRDCN	B191	SRGCR/L	B192

B Aluminum Insert (Positive)

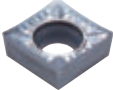

SC


 Square **90° Positive**
Relief Angle: 7°



Dimensions (mm)			
Size	d	t	d ₁
09	9.525	3.97	4.4
12	12.7	4.76	5.5

Workpiece	Steel	P					Machining types
	Stainless steel	M					
Cast iron	K						
Non-ferrous metal	N	✱	●	✱	●	✱	
Heat resistant alloy, Titanium alloy	S						
Hardened steel	H						

Inserts	Designation	Coated			Uncoated		Cutting Condition	
		PC5040	PD1005	PD1010	H01	H05	fn (mm/rev)	ap (mm)
AK 	SCGT 09T302-AK	●				●	0.02~0.30	0.10~4.00
	09T304-AK	●			●	●	0.04~0.40	0.10~5.00
	09T308-AK				●	●	0.03~0.40	0.10~5.00
	120404-AK				●	●	0.03~0.50	0.10~5.00
	120408-AK				●	●	0.04~0.60	0.15~5.50
	120416-AK						0.04~0.60	0.15~5.50
	SCGT 09T302-AR						●	0.03~0.40
09T304-AR					●	●	0.04~0.50	0.50~6.00
09T308-AR							0.04~0.50	0.50~6.50
120404-AR					●	●	0.05~0.60	0.50~6.50
120408-AR							0.05~0.60	0.50~7.00
120416-AR							0.05~0.60	0.50~7.00
AR 								

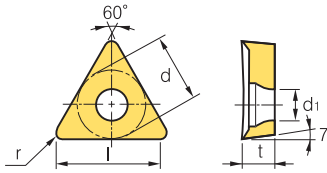
 Cutting edge geometry **A37~A49**
 Recommended chip breaker **B04~B15**
 Code system **B34~B35**
● : Stock item

Available tool holders			
Designation	Page	Designation	Page
SSBCR/L	B192	SSKCR/L	B193
SSDCN	B192	SSSCR/L	B193





Triangular 60° Positive
Relief Angle: 7°



Dimensions (mm)			
Size	d	t	d ₁
09	5.56	2.38	2.5
11	6.35	2.38	2.8
16	9.525	3.97	4.4

Workpiece	Steel	P					Machining types		
	Stainless steel	M						<ul style="list-style-type: none"> ● Continuous cutting ● General cutting ✦ Interrupted cutting 	
	Cast iron	K							
	Non-ferrous metal	N	✦	●	✦	✦			
	Heat resistant alloy, Titanium alloy	S							
Hardened steel	H								

Inserts	Designation	Coated			Uncoated		Cutting Condition	
		PC5040	PD1005	PD1010	H01	H05	f _n (mm/rev)	a _p (mm)
AK 	TCGT 090202-AK				●	●	0.01~0.12	0.05~3.00
	090204-AK				●	●	0.02~0.15	0.10~4.00
	110202-AK	●			●	●	0.02~0.20	0.05~4.00
	110204-AK	●			●	●	0.03~0.30	0.10~4.00
	110208-AK				●	●	0.03~0.40	0.10~5.00
	16T302-AK				●	●	0.02~0.30	0.05~5.00
	16T304-AK				●	●	0.03~0.40	0.10~5.50
	16T308-AK				●	●	0.03~0.50	0.10~5.50
	16T312-AK				●	●	0.04~0.60	0.15~5.50
	16T316-AK				●	●	0.05~0.80	0.15~5.50
	16T325-AK						0.06~0.90	0.20~7.00
AR 	TCGT 090202-AR						0.02~0.18	0.30~3.00
	090204-AR				●	●	0.02~0.25	0.30~5.00
	110202-AR						0.02~0.30	0.30~4.00
	110204-AR				●	●	0.03~0.40	0.30~5.00
	110208-AR						0.04~0.45	0.50~6.00
	16T302-AR				●	●	0.03~0.45	0.30~5.00
	16T304-AR				●	●	0.04~0.50	0.50~6.00
	16T308-AR				●	●	0.05~0.60	0.50~6.00
	16T312-AR						0.06~0.65	0.50~6.00
	16T316-AR						0.08~0.70	0.50~6.50
	16T325-AR						0.10~0.10	0.80~7.00

Cutting edge geometry **A37~A49**
 Recommended chip breaker **B04~B15**
 Code system **B34~B35**
● : Stock item

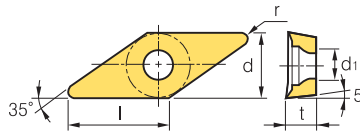
Available tool holders			
Designation	Page	Designation	Page
STACR/L	B193	STTCR/L	B194, 246
STFCR/L	B194	STWCR/L	B246
STGCR/L	B194		



B Aluminum Insert (Positive)

VB

Rhombic **35° Positive**
Relief Angle: 5°



Dimensions (mm)			
Size	d	t	d ₁
11	6.35	3.18	2.8
16	9.525	4.76	4.4

Workpiece	Steel	P					Machining types
	Stainless steel	M					
Cast iron	K						● General cutting
Non-ferrous metal	N	✱	●	✱	●	✱	✱ Interrupted cutting
Heat resistant alloy, Titanium alloy	S						
Hardened steel	H						

Inserts	Designation	Coated			Uncoated		Cutting Condition	
		PC5040	PD1005	PD1010	H01	H05	fn (mm/rev)	ap (mm)
AK 	VBGT 110302-AK				●	●	0.02~0.15	0.05~3.00
	110304-AK				●	●	0.02~0.15	0.10~4.00
	110308-AK					●	0.03~0.18	0.10~5.00
	160402-AK						0.03~0.30	0.05~4.00
	160404-AK				●	●	0.03~0.40	0.10~5.00
	160408-AK				●	●	0.03~0.50	0.10~5.00
	160412-AK					●	0.05~0.60	0.10~5.50
AR 	VBGT 110302-AR						0.02~0.35	0.30~3.00
	110304-AR						0.03~0.45	0.30~4.00
	110308-AR						0.03~0.50	0.50~6.00
	160402-AR						0.04~0.45	0.30~5.00
	160404-AR				●	●	0.04~0.50	0.50~6.00
	160408-AR				●	●	0.05~0.60	0.50~6.00
	160412-AR						0.05~0.70	0.50~6.50

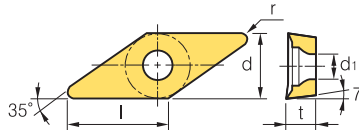
Cutting edge geometry A37~A49
 Recommended chip breaker B04~B15
 Code system B34~B35
 ● : Stock item

Available tool holders			
Designation	Page	Designation	Page
SVABR/L	B195	SVVBN	B196
SVHBR/L	B195	SVQBR/L	B222
SVJBR/L	B125, 195	SVUBR/L	B223





VC

Rhombic 35° Positive
Relief Angle: 7°



Dimensions (mm)			
Size	d	t	d ₁
11	6.35	3.18	2.8
13	7.94	3.18	3.4
16	9.525	4.76	4.4
22	12.7	5.56	5.6

Workpiece	Steel	P						Machining types	
	Stainless steel	M							● Continuous cutting
Cast iron	K							● General cutting	
Non-ferrous metal	N	✱	●	✱	✱	✱		✱ Interrupted cutting	
Heat resistant alloy, Titanium alloy	S								
Hardened steel	H								

Inserts	Designation	Coated			Uncoated		Cutting Condition	
		PC5040	PD1005	PD1010	H01	H05	fn (mm/rev)	ap (mm)
AK 	VCGT 110301-AK				●		0.02~0.15	0.05~3.00
	110302-AK	●			●	●	0.02~0.20	0.05~3.00
	110304-AK	●		●	●	●	0.02~0.25	0.10~4.00
	110308-AK				●	●	0.03~0.30	0.10~5.00
	130302-AK	●			●	●	0.02~0.35	0.10~5.00
	130304-AK	●			●	●	0.03~0.35	0.10~5.00
	130308-AK						0.04~0.40	0.10~5.00
	160402-AK				●	●	0.02~0.30	0.05~5.00
	160404-AK			●	●	●	0.03~0.40	0.10~5.00
	160408-AK			●	●	●	0.03~0.50	0.10~5.00
	160412-AK				●	●	0.03~0.50	0.10~5.00
	220516-AK				●	●	0.03~0.60	0.10~7.00
	220525-AK					●	0.05~0.70	0.10~7.00
	220530-AK				●	●	0.08~1.00	0.10~7.00
AR 	VCGT 110301-AR						0.02~0.20	0.10~3.00
	110302-AR				●	●	0.02~0.25	0.30~3.00
	110304-AR				●	●	0.03~0.35	0.30~4.00
	110308-AR						0.04~0.45	0.50~6.00
	130302-AR					●	0.02~0.40	0.50~3.00
	130304-AR				●	●	0.03~0.45	0.50~4.00
	130308-AR						0.04~0.50	0.50~5.00
	160402-AR				●	●	0.03~0.40	0.30~5.00
	160404-AR				●	●	0.04~0.50	0.50~6.00
	160408-AR				●	●	0.05~0.60	0.50~6.00
	160412-AR						0.06~0.65	0.50~6.50
	220516-AR						0.10~0.65	0.80~6.50
	220525-AR						0.10~0.70	0.80~7.00
	220530-AR				●	●	0.12~0.75	1.00~7.00

Cutting edge geometry **A37~A49**
 Recommended chip breaker **B04~B15**
 Code system **B34~B35**
 ● : Stock item

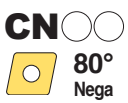
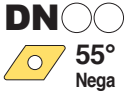
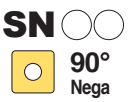
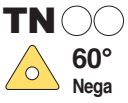
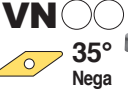
Available tool holders			
Designation	Page	Designation	Page
SVJCR/L	B125, 196, 222	SVQCR/L	B223
SVVCN	B196	SVUCR/L	B223



CBN

Multi-Corner Type (Negative)

Dimensions (mm)			
Size	d	t	d _i
12	12.7	4.76	5.16
15	12.7	4.76~6.358	3.4
16	9.525	4.76	3.81

Inserts	Designation	Coated					Uncoated					Available tool holders				
		DNC100	DNC250	DNC300	DNC350	DNC400	DB1000	DB2000	DBN250	DBN350	DBN700A	DBNX20	Designation	Page		
 CN 80° Nega	2NU-CNGA	120404	●	●	●	●	●				●		DCBNR/L	B167		
		120404F		●		●								DCLNR/L	B167/B208	
		120404T		●		●		●						MCKNR/L	B183	
		120404W		●										MCLNR/L	B183/B213	
		120404WF		●										MCMNN	B183	
		120408		●	●	●	●		●	●			●	PCBNR/L	B172	
		120408F			●		●							PCLNR/L	B173/B210	
		120408T			●		●		●							
		120408W			●		●		●				●			
		120408WF								●						
		120412		●	●	●	●									
		120412F			●		●									
		120412T			●		●									
		120412W			●				●				●			
120412WT							●									
T-2NU-CNGA	120404		●													
	120408		●		●											
4NU-CNGA	120404		●													
	120408		●		●											
	120412		●													
4NS-CNGA	120408					●										
	120412					●										
 DN 55° Nega	2NU-DNGA	150404		●	●	●			●	●			DDJNR/L	B168		
		150404F		●		●								MDJNR/L	B184	
		150404T		●		●								MDNNN	B184	
		150408		●	●	●		●	●	●				MDQNR/L	B185	
		150408F		●		●								MDUNR/L	B213	
		150408T		●		●		●	●					PDJNR/L	B173	
		150412		●		●								PDNNR/L	B174	
		150412F		●		●								PDSNR/L	B210	
		150412T		●		●								PDUNR/L	B211	
		150604		●	●	●										
		150608		●	●	●										
		4NU-DNGA	150404		●		●									
			150408		●		●									
			150412		●		●									
150608			●													
4NS-DNGA	150608					●										
	150612					●										
 SN 90° Nega	4NU-SNGA	120404		●							●	DSBNR/L	MSBNR/L	B168	B185	
		120408		●								●	MSDNN	MSKNR/L	B185	B186/B213
													MSRNR/L	MSSNR/L	B186	B187
													PSBNR/L	PSDNN	B175	B176
													PSKNR/L		B176/B211	
 TN 60° Nega	3NU-TNGA	160404		●		●		●	●	●	●	MTENN	MTFNR/L	B187	B187/B214	
		160404T		●									MTGNR/L	MTJNR/L	B188	B188
		160408		●		●						●	PTFNR/L	PTGNR/L	B177/B211	B178
		160408F		●									PTTNR/L	WTENN	B178	B179
		160408T		●									WTJNR/L	WTXNR/L	B179	B179
		160412					●									
 VN 35° Nega	2NU-VNGA	160404	●	●	●	●				●	●	MVJNR/L		B188		
		160404F		●		●							MVQNR/L		B189	
		160404T		●		●							MVUNR/L		B214	
		160408		●	●	●	●		●	●	●	●	MVVNN		B189	
		160408F		●		●										
		160408T		●		●				●						
		160408		●					●							
T-2NU-VNGA	160408		●					●								

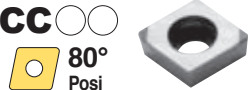
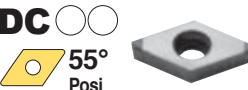

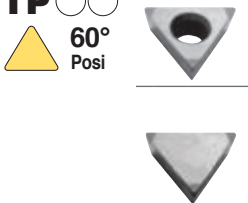
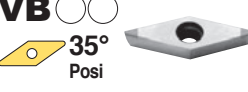
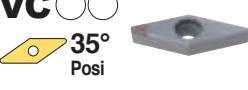
● : Stock item



CBN

Multi-Corner Type (Positive)

Dimensions (mm)			
Size	d	t	d ₁
06	6.35	2.38	2.8
07	6.35	2.38	2.8
09	9.525	3.97	4.4
11	9.525	3.97	4.4
16	9.525	4.76	3.81

Inserts	Designation	Coated					Uncoated					Available tool holders			
		DNC100	DNC250	DNC300	DNC350	DNC400	DB1000	DB2000	DBN250	DBN350	DBN700A	DBNX20	Designation	Page	
CC ○○○ 	2NU-CCGW	060202	●										SCACR/L	B190	
		060202T	●										SCLCR/L	B190/B215/B225	
		060204	●					●							
		060204F	●												
		060204T	●												
		060208						●							
		09T302	●												
		09T304	●	●	●			●	●		●				
		09T304T	●												
		09T308	●	●	●			●	●		●				
	09T308T	●													
	09T308W	●													
DC ○○○ 	2NU-DCGW	070204	●				●						SDACR/L	B190	
		070208	●										SDJCR/L	B191	
		070208T						●					SDNCN	B191	
		11T302	●										SDQCR/L	B217	
		11T304	●	●	●			●	●				SDUCR/L	B218	
		11T304F	●										SDZCR/L	B219	
		11T304T	●												
		11T308	●	●	●				●		●				
		11T308T	●												
		T-2NU-DCGW	11T304	●											
		11T308	●	●											
TC ○○○ 	3NU-TCGW	090204	●										STACR/L	B193	
		090204F	●										STFCR/L	B194/B220	
		090204T	●										STGCR/L	B194	
													STTCR/L	B194	
TP ○○○ 	3NU-TPGW	110304	●	●			●	●			●				
		110304F	●												
		110304T	●												
		110308	●	●				●	●		●				
		110308F	●												
		110308T	●												
		3NU-TPGN	110308					●	●					CTFPR/L	B182/B212
			160304	●										CTGPR/L	B182
			160308	●											
		3NU-TPGB	110304	●						●				CTFPR/L	B182/B212
		110304T	●										CTGPR/L	B182	
		110308	●						●						
		110308F	●												
		110308T	●												
VB ○○○ 	2NU-VBGW	160402	●										SVABR/L	B195	
		160404	●	●	●			●	●		●		SVHBR/L	B195	
		160404F	●										SVJBR/L	B195	
		160404T	●										SVQBR/L	B222	
		160408	●	●	●				●	●			SVUBR/L	B223	
		160408F	●												
		160408T	●												
		T-2NU-VBGW	160408			●									
VC ○○○ 	2NU-VCGW	160404	●	●											
		160404F	●												
		160404T	●												
		160408	●												
		160408F	●												
		160408T	●						●	●					
		T-2NU-VCGW	160404	●											
			160408	●											

● : Stock item



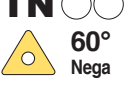




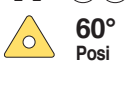


CBN

Regrinding Type (Negative/Positive)

Dimensions (mm)			
Size	d	t	d _i
09	9.525	3.97	4.4
11	6.35~9.525	3.8~3.97	3.4~4.4
12	12.7	4.76	5.16

Dimensions (mm)			
Size	d	t	d _i
15	12.7	4.76	5.16
16	9.525	4.76	3.81~4.4









Inserts	Designation	Coated						Uncoated						Available tool holders			
		DNC100	DNC250	DNC300	DNC350	DNC400	DB1000	DB2000	DBN250	DBN350	DBN700A	DBNX20	Designation		Page		
CN ○○  80° Nega	CNMA	120404							●				DCBNR/L	MCKNR/L	B167	B183	
		120408							●		●		DCLNR/L	MCLNR/L	B167/B208	B183/B213	
	T-CNMA	120408							●				PCBNR/L	MCMNN	B172	B183	
													PCLNR/L		B173/B210		
DN ○○  55° Nega	DNMA	150404							●				DDJNR/L	MDJNR/L	B168	B184	
		150408							●	●			MDNNN	MDQNR/L	B184	B185	
													MDUNR/L	PDJNR/L	B213	B173	
													PDNNR/L	PDSNR/L	B174	B210	
													PDUNR/L		B210		
TN ○○  60° Nega	TNMA	160404							●				MTENN	MTFNR/L	B187	B187/B214	
		160408							●				MTGNR/L	MTJNR/L	B188	B188	
													PTFNR/L	PTGNR/L	B177/B211	B178	
													PTTNR/L	WTENN	B178	B179	
													WTJNR/L	WTXNR/L	B179	B179	
VN ○○  35° Nega	T-VNMA	160404							●				MVJNR/L		B188		
	VNMA	160404							●				MVQNR/L		B189		
		160408							●				MVUNR/L		B214		
													MVVNN		B189		
CC ○○  80° Posi	CCMW	09T304							●				SCACR/L		B190		
													SCLCR/L		B190/B215/B225		
DC ○○  50° Posi	DCGW	11T308							●				SDACR/L		B190		
	T-DCGW	11T308							●				SDJCR/L		B191		
													SDNCN		B191		
VB ○○  35° Posi	VBMW	160404							●				SVABR/L		B195		
		160408							●				SVHBR/L		B195		
													SVJBR/L		B195		
													SVQBR/L		B222		
													SVUBR/L		B223		
TP ○○  60° Posi	T-TPGB	110304								●			CTFPR/L		B182/B212		
	TPGB	110304							●	●			CTGPR/L		B182		
		110308							●								

● : Stock item



PCD**Insert (Negative/Positive)**

Dimensions (mm)				Dimensions (mm)			
Size	d	t	d ₁	Size	d	t	d ₁
06	6.35	2.38	2.8	11	9.525	3.97	4.4
07	6.35	2.38	2.8	12	12.7	4.76	5.16
08	7.94	2.38	3.4	15	12.7	4.76	5.16
09	9.525	3.18	4.4	16	9.525	4.76	3.81

Inserts	Designation	PCD			Available tool holders				
		DP90	DP150	DP200	Designation		Page		
CN ○○  80° Nega	CNMM	120404		●		DCBNR/L	DCLNR/L	B167	B167
		120408		●		MCKNR/L	MCLNR/L	B183	B183
						MCMNN	PCBNR/L	B183	B172
						PCLNR/L		B173	
DN ○○  55° Nega	DNMM	150404		●		DDJNR/L	MDJNR/L	B168	B184
		150408		●		MDNNN	MDQNR/L	B184	B185
						MDUNR/L	PDJNR/L	B213	B173
						PDNNR/L	PDSNR/L	B174	B210
						PDUNR/L		B210	
CC ○○  80° Posi	CCMW	120404		●		SCACR/L		B190	
	CCMT	060202		●		SCLCR/L		B190/B215/B225	
		060204		●					
		09T304		●					
		09T308		●					
DC ○○  55° Posi	DCMT	070202		●		SDACR/L		B195	
		070204		●		SDJCR/L		B191	
		11T302		●		SDNCN		B191	
		11T304		●		SDQCR/L		B217	
		11T308		●		SDUCR/L		B218	
	DCGT	11T304		●		SDZCR/L		B219	
	TP ○○  60° Posi	TPGW	080204		●				
090204				●					
090208				●					
110304				●					
110308				●					
VB ○○ VC ○○  35° Posi	VBGW	160404		●					
	VBMT	110304		●		SVHBR/L		B195	
		110308		●		SVJBR/L		B195	
		160404		●		SVUBR/L		B223	
		160408		●					
	VCMT	110304		●		SVVCN		B196	
		110308		●					
160404			●						
TP ○○  60° Posi	TPGN	110304		●					
		110308		●					
SP ○○  90° Posi	SPGN	090304		●		CSDPN		B181	
						CSKPR/L		B182/B212	

● : Stock item

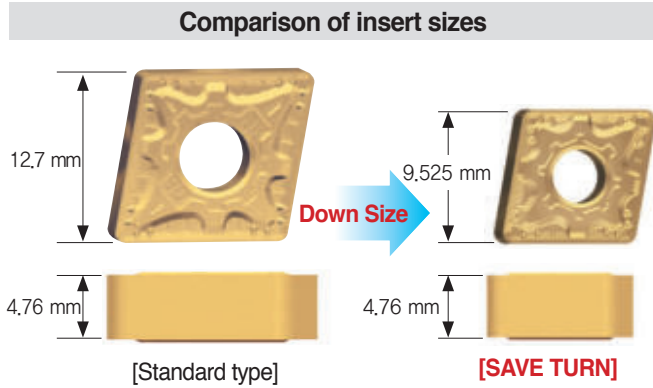
B Technical Information for SAVE TURN

Economical small insert with powerful cutting performance

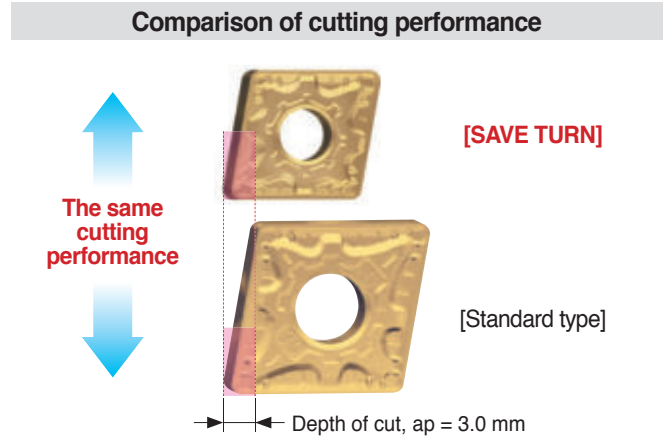
SAVE TURN

- Strongly recommended turning insert for machining smaller diameter than $\varnothing 100$
- Small but powerful and economical insert which performs the same like standard-sized inserts under the depth of cut of 3.0 mm

Features


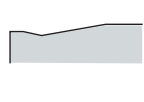

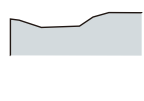

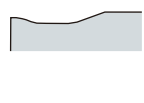


- Optimized size of the same performance like the standard type

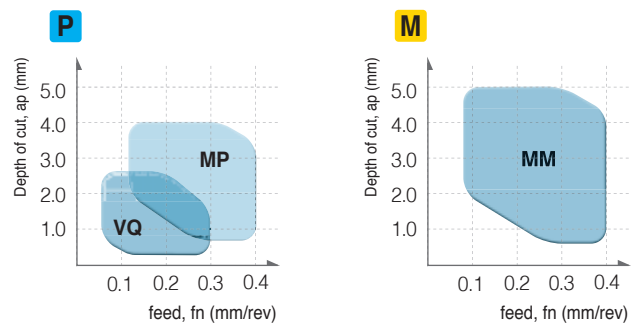


- Performs the same like standard type inserts under the depth of cut of 3.0 mm

Features of chip breaker

Insert shape	Cutting edge	Features
		<ul style="list-style-type: none"> • For finishing steel • Efficient chip breaking and low cutting resistance • Various application available at low depth of cut • Recommended depth of cut: 0.5~2.5 mm
		<ul style="list-style-type: none"> • For medium cutting of steel • 4 dots for improved chip control in medium cutting to finishing • Stable chip evacuation at high depth of cut • Stable tool life due to lower cutting loads at high feed • Recommended depth of cut: 0.5~4.0 mm
		<ul style="list-style-type: none"> • For medium cutting of stainless steel • Limits plastic deformation caused by heat • Stable tool life thanks to the balanced cutting performance and toughness • Stable chip flow at high speeds and feeds • Recommended depth of cut: 0.5~5.0 mm

Application area of chip breaker



VQ: Depth of cut, $a_p = 0.5\sim 2.5$ mm/feed, $f_n = 0.05\sim 0.30$ mm/rev

MP: Depth of cut, $a_p = 0.5\sim 4.0$ mm/feed, $f_n = 0.15\sim 0.40$ mm/rev

MM: Depth of cut, $a_p = 0.5\sim 5.0$ mm/feed, $f_n = 0.10\sim 0.40$ mm/rev

Application example

Alloy steel (SCM440)

- **Cutting conditions** vc (m/min) = 250, f_n (mm/rev) = 0.25
 a_p (mm) = 2.0~3.0, continuous cutting, wet

- **Cutting Result**



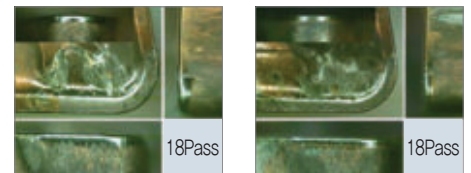
CNMG090408-HM
SAVE TURN

CNMG120408-HM
Standard type

Alloy steel (SCM440)

- **Cutting conditions** vc (m/min) = 250, f_n (mm/rev) = 0.25
 a_p (mm) = 2.0~3.0, interrupted cutting, wet

- **Cutting Result**



CNMG090408-HM
SAVE TURN

CNMG120408-HM
Standard type





Type	Picture	Designation	Coated						Dimensions (mm)				cutting conditions		Configuration	Available tool holders page	
			NC9215	NC9225	NC5330	NC6310	NC9125	NC9135	PC9030	d	t	r	d ₁	ap (mm)			fn (mm/rev)
C type		CNMG 090408-VQ		●					9.525	4.76	0.8	3.81	0.50~2.50	0.08~0.30		B116 B119	
		090412-VQ		●					9.525	4.76	1.2	3.81	0.50~2.50	0.10~0.30			
		CNMG 090404-MP							9.525	4.76	0.4	3.81	0.50~4.00	0.10~0.40		B116 B119	
		090408-MP							9.525	4.76	0.8	3.81	0.50~4.00	0.15~0.40			
		090412-MP							9.525	4.76	1.2	3.81	0.50~4.00	0.15~0.45			
		CNMG 090404-MM							9.525	4.76	0.4	3.81	0.50~5.00	0.08~0.35		B116 B119	
		090408-MM							9.525	4.76	0.8	3.81	0.50~5.00	0.10~0.40			
		090412-MM							9.525	4.76	1.2	3.81	0.50~5.00	0.12~0.45			
	D type		DNMG 110508-VQ		●					9.525	5.56	0.4	3.81	0.50~2.50	0.08~0.30		B116 B117 B119 B120
110512-VQ				●					9.525	5.56	0.8	3.81	0.50~2.50	0.10~0.30			
		DNMG 110504-MP							9.525	5.56	0.4	3.81	0.50~4.00	0.10~0.40		B116 B117 B119 B120	
		110508-MP							9.525	5.56	0.8	3.81	0.50~4.00	0.15~0.40			
		110512-MP							9.525	5.56	1.2	3.81	0.50~4.00	0.15~0.45			
		DNMG 110504-MM							9.525	5.56	0.4	3.81	0.50~5.00	0.08~0.35		B116 B117 B119 B120	
		110508-MM							9.525	5.56	0.8	3.81	0.50~5.00	0.10~0.40			
		110512-MM							9.525	5.56	1.2	3.81	0.50~5.00	0.12~0.45			
S type			SNMG 090408-VQ		●					9.525	4.76	0.4	3.81	0.50~2.50	0.08~0.30		B117 B118 B120
	090412-VQ								9.525	4.76	0.8	3.81	0.50~2.50	0.10~0.30			
		SNMG 090404-MP							9.525	4.76	0.4	3.81	0.50~4.00	0.10~0.40		B117 B118 B120	
		090408-MP							9.525	4.76	0.8	3.81	0.50~4.00	0.15~0.40			
		090412-MP							9.525	4.76	1.2	3.81	0.50~4.00	0.15~0.45			
		SNMG 090404-MM							9.525	4.76	0.4	3.81	0.50~5.00	0.08~0.35		B117 B118 B120	
		090408-MM							9.525	4.76	0.8	3.81	0.50~5.00	0.10~0.40			
		090412-MM							9.525	4.76	1.2	3.81	0.50~5.00	0.12~0.45			
	W type		WNMG 060404-VQ							9.525	4.76	0.4	3.81	0.30~2.00	0.06~0.30		B119 B120
060408-VQ									9.525	4.76	0.8	3.81	0.50~2.00	0.08~0.30			
060412-VQ									9.525	4.76	1.2	3.81	0.50~2.00	0.10~0.30			
		WNMG 060404-MP	●	●	●	●			9.525	4.76	0.4	3.81	0.50~3.50	0.10~0.40		B119 B120	
		060408-MP	●	●	●	●	●		9.525	4.76	0.8	3.81	0.50~3.50	0.15~0.40			
		060412-MP							9.525	4.76	1.2	3.81	0.50~3.50	0.15~0.45			
		WNMG 060404-MM							9.525	4.76	0.4	3.81	0.50~4.00	0.08~0.35		B119 B120	
		060408-MM				●	●	●	9.525	4.76	0.8	3.81	0.50~4.00	0.10~0.40			
		060412-MM				●	●	●	9.525	4.76	1.2	3.81	0.50~4.00	0.12~0.45			

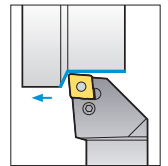
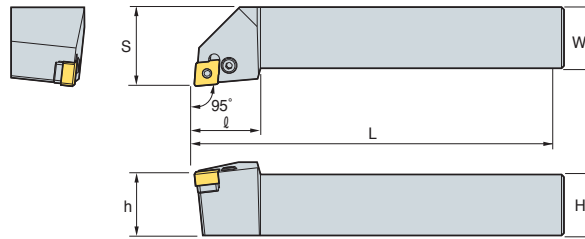
● : Stock item

B SAVE TURN Holder

PCLNR/L



CN□□



95°

• R type insert (mm)

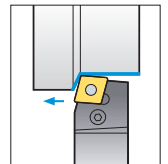
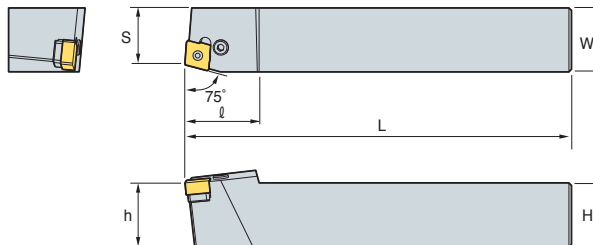
Designation	H	W	L	S	h	ℓ	Insert	Lever	Screw	Shim	Shim pin	Wrench	Shim Pin Punch
PCLNR/L 1616-H09-4N	16	16	100	20	16	20	CN□□ 0904□□						
2020-K09-4N	20	20	125	25	20	25							
2525-M09-4N	25	25	150	32	25	27							

➔ Applicable inserts B115

PCBNR/L



CN□□



75°

• R type insert (mm)

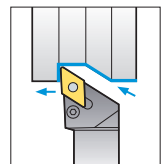
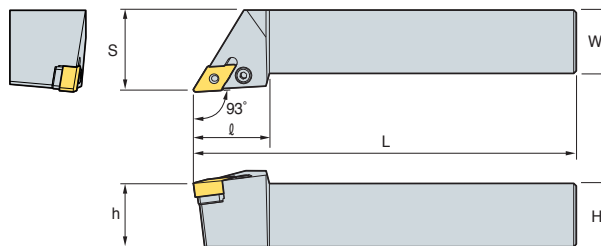
Designation	H	W	L	S	h	ℓ	Insert	Lever	Screw	Shim	Shim pin	Wrench	Shim Pin Punch
PCBNR/L 2020-K09-4N	20	20	125	17	20	27	CN□□ 0904□□						
2525-M09-4N	25	25	150	22	25	29							

➔ Applicable inserts B115

PDJNR/L



DN□□



93°

• R type insert (mm)

Designation	H	W	L	S	h	ℓ	Insert	Lever	Screw	Shim	Shim pin	Wrench	Shim Pin Punch
PDJNR/L 2020-K11-5N	20	20	125	25	20	25	DN□□ 1105□□						
2525-M11-5N	25	25	150	32	25	30							

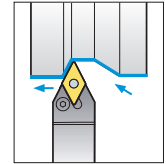
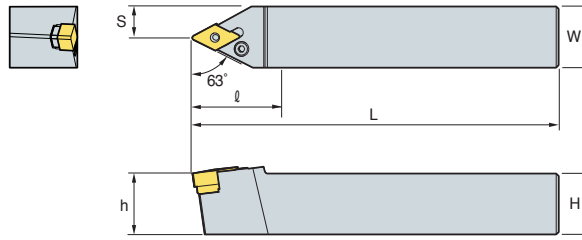
➔ Applicable inserts B115



PDNNR/L



DN□□



63°

• R type insert
(mm)

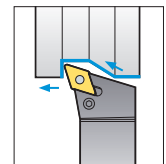
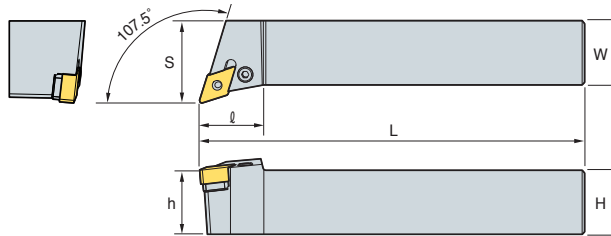
Designation	H	W	L	S	h	ℓ	Insert	Lever	Screw	Shim	Shim pin	Wrench	Shim Pin Punch
PDNNR/L 2020-K11-5N	20	20	125	25	20	30	DN□□ 1105□□						
2525-M11-5N	25	25	150	32	25	30							

↻ Applicable inserts B115

PDQNR/L



DN□□



107.5°

• R type insert
(mm)

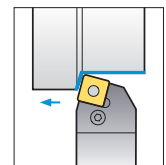
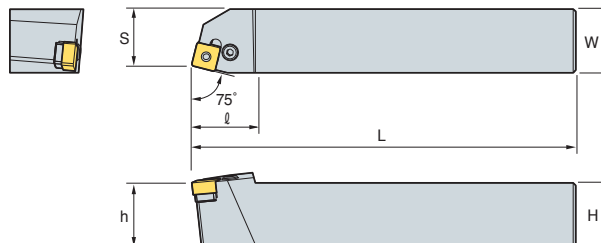
Designation	H	W	L	S	h	ℓ	Insert	Lever	Screw	Shim	Shim pin	Wrench	Shim Pin Punch
PDQNR/L 2020-K11-5N	20	20	125	25	20	30	DN□□ 1105□□						
2525-M11-5N	25	25	150	32	25	30							

↻ Applicable inserts B115

PSBNR/L



SN□□



75°

• R type insert
(mm)

Designation	H	W	L	S	h	ℓ	Insert	Lever	Screw	Shim	Shim pin	Wrench	Shim Pin Punch
PSBNR/L 2020-K09-4N	20	20	125	17	20	25	SN□□ 0904□□						
2525-M09-4N	25	25	150	22	25	25							

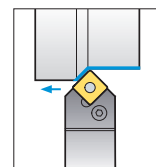
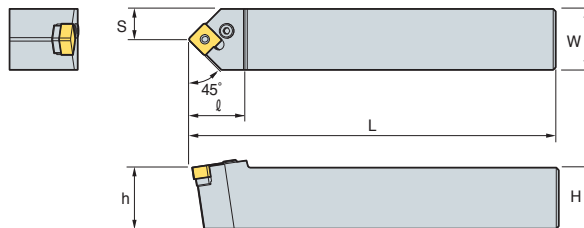
↻ Applicable inserts B115



PSDNN



SN□□



45°

• R type insert
(mm)

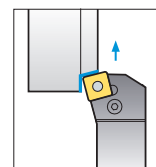
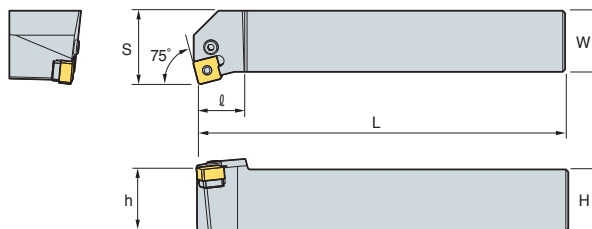
Designation		H	W	L	S	h	ℓ	Insert	Lever	Screw	Shim	Shim pin	Wrench	Shim Pin Punch
PSDNN	2020-K09-4N	20	20	125	17	20	25	SN□□0904□□						
	2525-M09-4N	25	25	150	22	25	25							

➔ Applicable inserts B115

PSKNR/L



SN□□



75°

• R type insert
(mm)

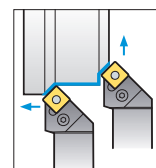
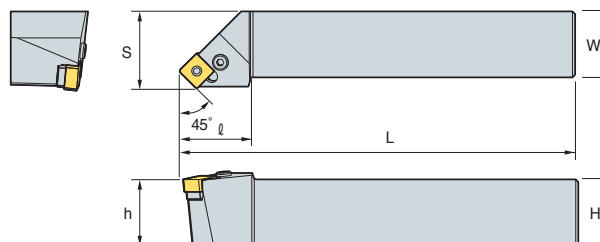
Designation		H	W	L	S	h	ℓ	Insert	Lever	Screw	Shim	Shim pin	Wrench	Shim Pin Punch
PSKNR/L	2020-K09-4N	20	20	125	17	20	25	SN□□0904□□						
	2525-M09-4N	25	25	150	22	25	25							

➔ Applicable inserts B115

PSSNR/L



SN□□



45°

• R type insert
(mm)

Designation		H	W	L	S	h	ℓ	Insert	Lever	Screw	Shim	Shim pin	Wrench	Shim Pin Punch
PSSNR/L	2020-K09-4N	20	20	125	17	20	25	SN□□0904□□						
	2525-M09-4N	25	25	150	22	25	25							

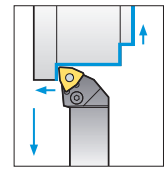
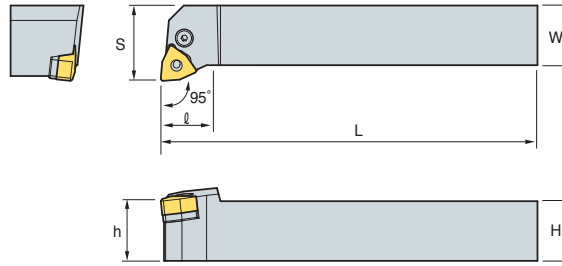
➔ Applicable inserts B115



PWLNRL/L



WN□□



95°

• R type insert (mm)

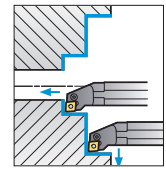
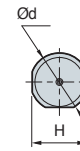
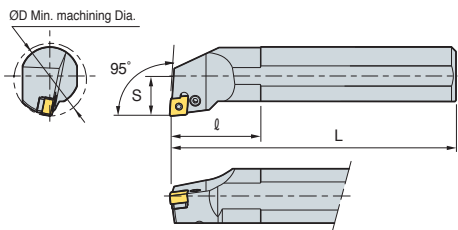
Designation	H	W	L	S	h	l	Insert	Lever	Screw	Shim	Shim pin	Wrench	Shim Pin Punch
PWLNRL/L 1616-H06	16	16	100	20	16	20	WN□□0604□□						
2020-K06	20	20	125	25	20	20							
2525-M06	25	25	150	32	25	20							

↻ Applicable inserts **B115**

PCLNR/L



CN□□



95°

• R type insert (mm)

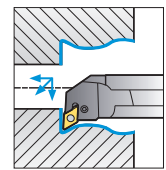
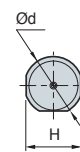
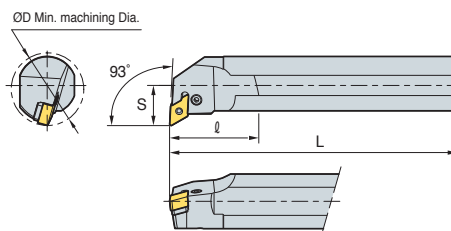
Designation	ØD	Ød	H	L	S	l	Insert	Lever	Screw	Shim	Shim pin	Wrench	Shim Pin Punch
S20Q-PCLNR/L-09-4N	25	20	18	180	13	50	CN□□0904□□						
S25R-PCLNR/L-09-4N	32	25	23	200	17	50							
S32S-PCLNR/L-09-4N	40	32	30	250	22	50							

↻ Applicable inserts **B115**

PDUNR/L



DN□□



93°

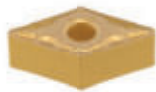
• R type insert (mm)

Designation	ØD	Ød	H	L	S	l	Insert	Lever	Screw	Shim	Shim pin	Wrench	Shim Pin Punch
S32S-PDUNR/L-11-5N	40	32	30	250	22	30	DN□□1105□□						
S40T-PDUNR/L-11-5N	50	40	38	300	27	50							

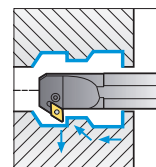
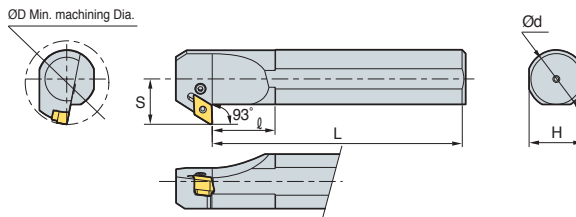
↻ Applicable inserts **B115**



PDZNR/L



DN□□



93°

• R type insert (mm)

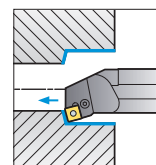
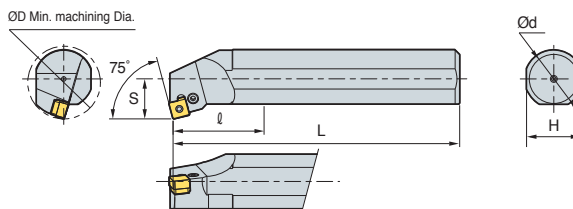
Designation	ØD	Ød	H	L	S	ℓ	Insert	Lever	Screw	Shim	Shim pin	Wrench	Shim Pin Punch
S32S-PDZNR/L-11-5N	40	32	30	250	22	30	DN□□1105□□						
S40T-PDZNR/L-11-5N	50	40	38	300	27	50							

↻ Applicable inserts B115

PSKNR/L



SN□□



75°

• R type insert (mm)

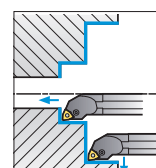
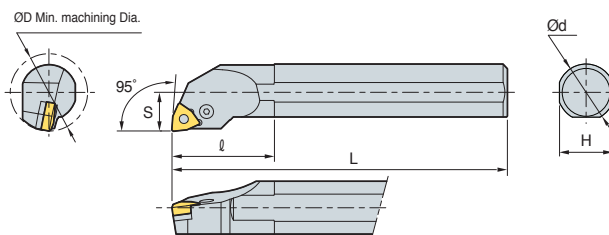
Designation	ØD	Ød	H	L	S	ℓ	Insert	Lever	Screw	Shim	Shim pin	Wrench	Shim Pin Punch
S25R-PSKNR/L-09-4N	32	25	23	200	17	32	SN□□0904□□						
S32S-PSKNR/L-09-4N	40	32	30	250	22	32							

↻ Applicable inserts B115

PWLNR/L



WN□□



95°

• R type insert (mm)

Designation	ØD	Ød	H	L	S	ℓ	Insert	Lever	Screw	Shim	Shim pin	Wrench	Shim Pin Punch						
S20S-PWLNR/L-06	25	20	18	250	13	40	WN□□0604□□												
S25R-PWLNR/L-06	32	25	23	200	17	40								LV3B	VHX0512B	-	-	-	-
S32S-PWLNR/L-06	44	32	30	250	22	45								LV3B	VHX0617B	SW317	SW317	HW25L	LSPS3

↻ Applicable inserts B115



Excellent for precision machining

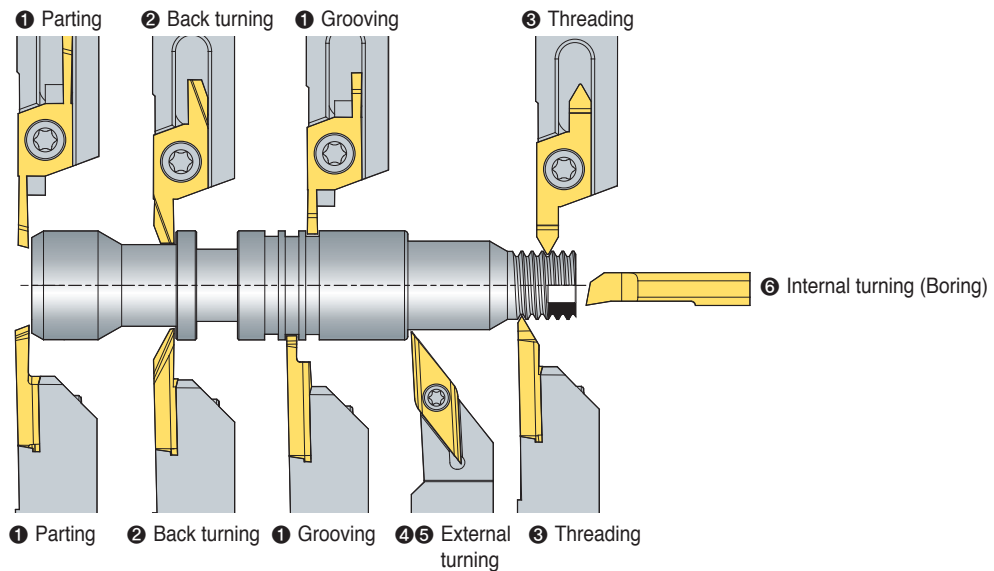
Auto Tools

- High precision machining of small parts and complex forms, etc.
- High quality products through stable machining
- Exclusive insert for automatic lathes

Type



Application example



Index

Specification	1 Parting and Grooving						2 Back turning			Specification	3 Threading	
Holder	SXGNR/L	SXGNR/L	SBHR/L	SBHR/L	MGEHR/L	KGEHR/L	SXGNR/L	SXGNR/L	SBHR/L	Holder	SXGNR/L	SBHR/L
Insert	SG	SC	SBG	SBC	MGMN	KGMM	SB	SGB	SBB	Insert	ST	SBT
Holder size	10~20mm	10~20mm	10~16mm	10~16mm	10~16mm	10~16mm	10~20mm	10~20mm	10~16mm	Shank diameter	10~20mm	10~16mm
Insert shape										Insert shape		
Cutting width	1~3mm	1~3mm	0.7~2.0mm	0.7~2.0mm	1.5~2.5mm	1.5~2.5mm	2~4mm	2~3mm	3.18mm	ØDmin	Pitch ranges 0.5~1.5 / 1.5~3.0	Pitch ranges 0.2~1.5 / 1.0~2.0
ØDmax	Ø18	Ø18	Ø16	Ø16	Ø32	Ø32	Tmax 8.0	Tmax 8.5	Tmax 8.0	Page	B140	B137
Page	B140	B140	B137	B137	B144	B143	B140	B140	B137			

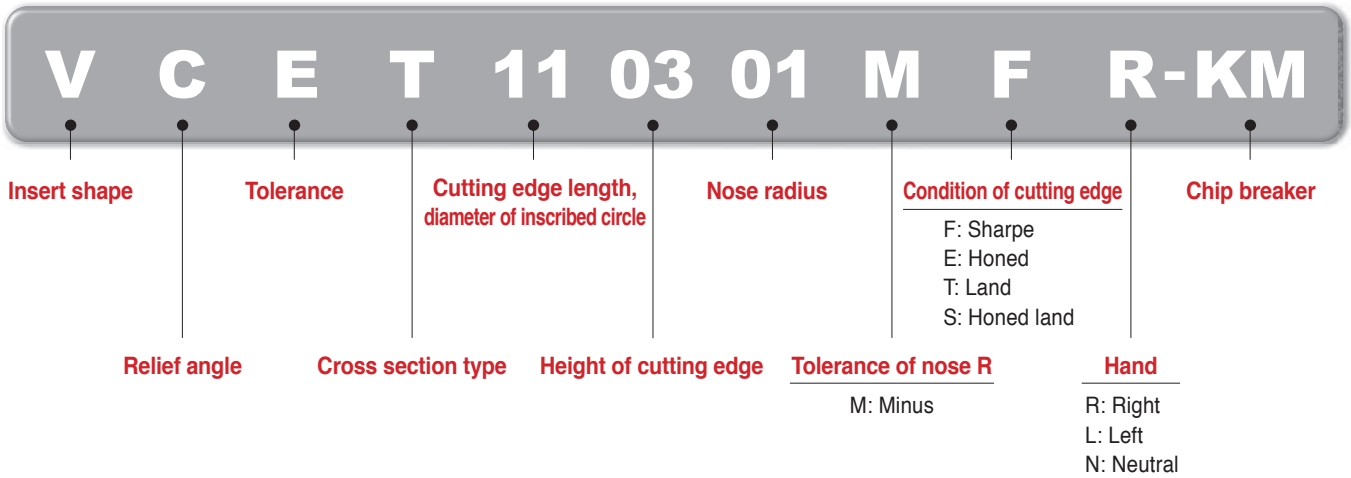
Specification	4 External turning and Copy machining				5 External turning and Facing			Specification	6 Internal turning (Boring)				
Holder	SDJCR/L	SDNCN	SVJBR/L	SVJCR/L	SCACR/L	SCLCR/L	STACR/L	Holder	SCLCR/L	STUBR/L	STUPR/L	SWUBR/L	MSB
Insert	DC□T	DC□T	VB□T	VC□T	CC□T	CC□T	TC□T	Insert	CC□T	TB□T	TP□T	WB□T	-
Holder size	8~16mm	8~16mm	10~16mm	10~16mm	8~16mm	8~16mm	8~10mm	Shank diameter	Ø4~Ø10	Ø8	Ø8	Ø5~Ø8	Ø4~Ø6
Insert shape								Insert shape					
Feature	Offset "0"				Offset "0"			ØDmin	Ø5	Ø8	Ø10	Ø5.5	Ø3.2
Page	B123	B124	B125	B125	B123	B123	B124	Page	B225	B225	B226	B227	B147~B151

Auto Tools (ISO type)

- ISO inserts for automatic lathes
- Precise R shape with the use of minus tolerance of nose R
- Tolerance class precise enough in no need for adjusting tools with the use of accurate cutting edge height
- Sharp blade for excellent chip control and surface roughness with low cutting force
- High precision tools for electrical/ electronics instruments and medical instruments


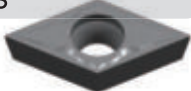



Code system (ISO type)



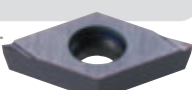
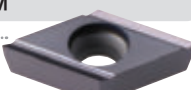
VP1/MS/FS chip breaker

- Exclusive chip breaker for hard-to-cut materials such as titanium alloy, Inconel, stainless steel, etc.
- Minimized cutting heat by reducing contact area between chips and rake surface with the use of high positive blade

<p>VP1</p>  <ul style="list-style-type: none"> • Hard cutting edge for medium cutting • Optimal width of chip breaker by each depth of cuts realizes wide workpiece machining 	<p>MS</p>  <ul style="list-style-type: none"> • Good surface finish for medium cutting • Preventing welding in titanium machining • Increasing chip evacuation in high feed machining • Protecting cutting edge due to structure for good chip evacuation 	<p>FS</p>  <ul style="list-style-type: none"> • For finishing (for surface roughness) • 1st recommended chip breaker for chip control • Better surface roughness, surface finish and chip control
---	--	---

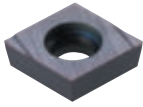
KF/KM chip breaker, ground type for grooving

- Ground chip breaker with sharp cutting edge
- High precision insert of E-class tolerance with accurate nose radius

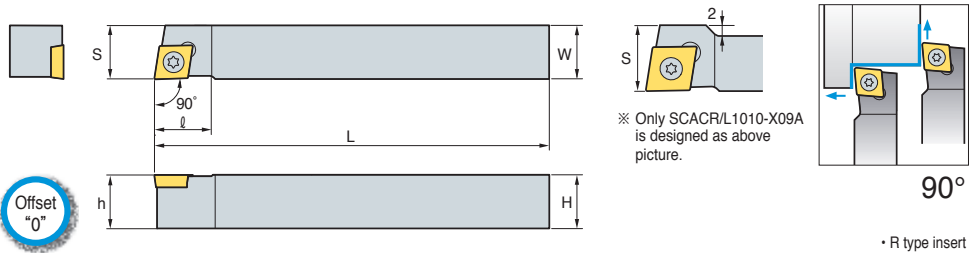
<p>KF</p>  <ul style="list-style-type: none"> • For finishing • Low cutting loads with sharp cutting edges • Longer tool life due to lower chip evacuation resistance at high speed • Excellent surface roughness 	<p>KM</p>  <ul style="list-style-type: none"> • For medium cutting to finishing • Better chip flow due to wide chip pockets • Longer tool life and better cutting action due to improved chip evacuation • Excellent surface roughness
---	---



SCACR/L



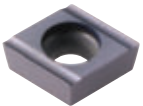
CC□T



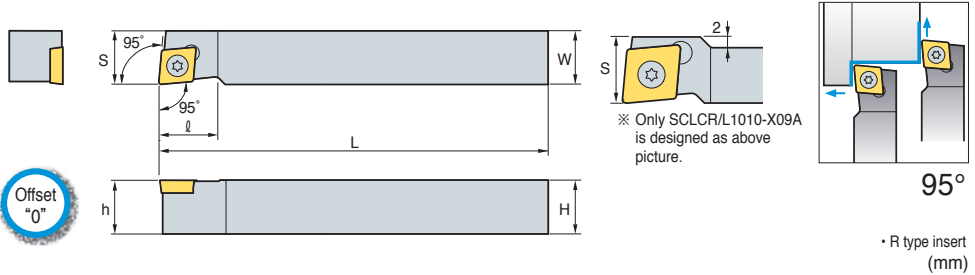
Designation	H	W	L	S	h	l	Insert	Screw	Wrench
SCACR/L 0808-X06A	8	8	120	8	8	10	CC□T0602□□	FTKA02565	TW07P
1010-X06A	10	10	120	10	10	10			
1010-X09A	10	10	120	12	10	13			
1212-X09A	12	12	120	12	12	16	CC□T09T3□□	FTKA0410	TW15P
1616-X09A	16	16	120	16	16	16			

➔ Applicable inserts B73~B77, B103

SCLCR/L



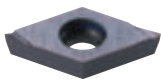
CC□T



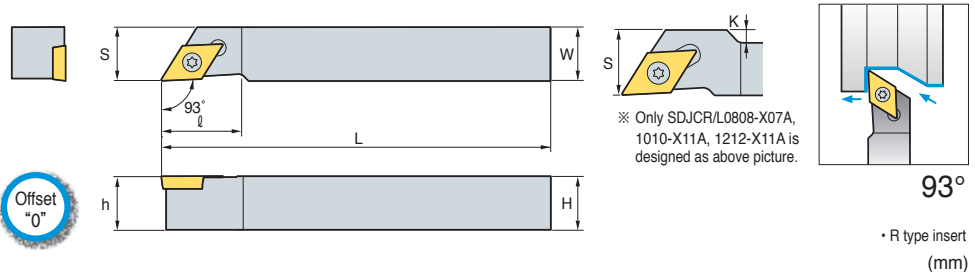
Designation	H	W	L	S	h	l	Insert	Screw	Wrench
SCLCR/L 0808-X06A	8	8	120	8	8	10	CC□T0602□□	FTKA02565	TW07P
1010-X06A	10	10	120	10	10	10			
1010-X09A	10	10	120	12	10	13			
1212-X09A	12	12	120	12	12	16	CC□T09T3□□	FTKA0410	TW15P
1616-X09A	16	16	120	16	16	16			

➔ Applicable inserts B73~B77, B103

SDJCR/L



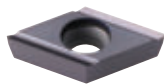
DC□T



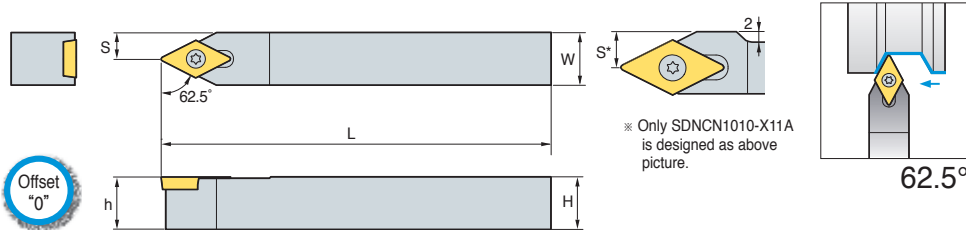
Designation	H	W	L	S	h	K	l	Insert	Screw	Wrench
SDJCR/L 0808-X07A	8	8	120	10	8	2	18	DC□T0702□□	FTKA02565	TW07P
1010-X07A	10	10	120	10	10	-	15			
1010-X11A	10	10	120	14	10	4	18	DC□T11T3□□	FTKA0410	TW15P
1212-X11A	12	12	120	14	12	2	18			
1616-X11A	16	16	120	16	16	-	22			

➔ Applicable inserts B79~B82, B104

SDNCN



DC□T

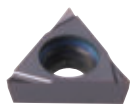


• R type insert (mm)

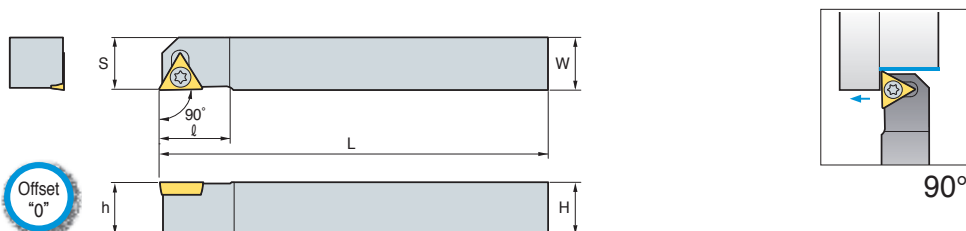
Designation	H	W	L	S	h	Insert	Screw	Wrench
SDNCN 0808-X07A	8	8	120	4	8	DC□T0702□□	FTKA02565	TW 07P
1010-X07A	10	10	120	5	10			
1010-X11A	10	10	120	7	10	DC□T11T3□□	FTKA0410	TW 15P
1212-X11A	12	12	120	6	12			
1616-X11A	16	16	120	8	16			

➔ Applicable inserts B79~B82, B104

STACR/L



TC□T



• R type insert (mm)

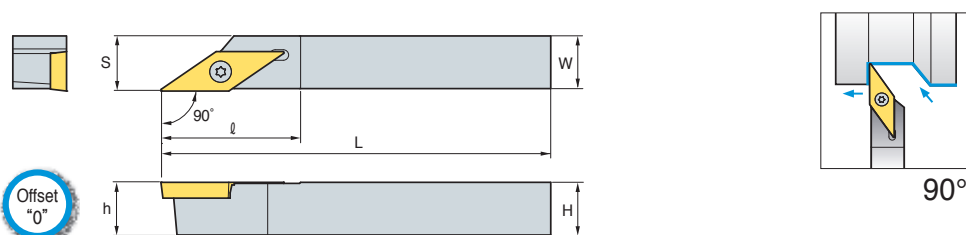
Designation	H	W	L	S	h	K	ℓ	Insert	Screw	Wrench
STACR/L 0808-X08A	8	8	120	8	8	1	12	TC□T0802□□	FTNA0206	TW06P
1010-X08A	10	10	120	10	10	3	12			

➔ Applicable inserts B88~B89, B107

SVACR/L



VC□□



• R type insert (mm)

Designation	H	W	L	S	h	ℓ	Insert	Screw	Wrench
SVACR/L 0808-X12A	8	8	120	8.5	8	26	VC□□T1203□□	FTKA02565	TW07P
1010-X12A	10	10	120	10.5	10	26			
1212-X12A	12	12	120	12.5	12	26			
1616-X12A	16	16	120	16.5	16	26			
SVACR/L 0808-X12C	8	8	120	8.5	8	26	VC□□X1203□□	FTKA02565	TW07P
1010-X12C	10	10	120	10.5	10	26			
1212-X12C	12	12	120	12.5	12	26			
1616-X12C	16	16	120	16.5	16	26			

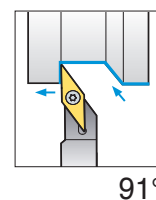
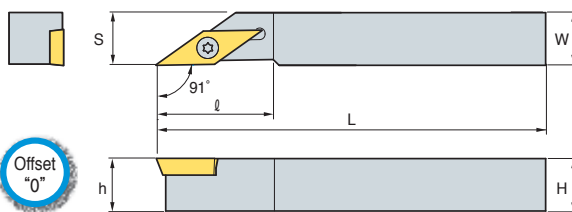
➔ Applicable inserts B97~B99, B109



SVAPR/L



VP□□



91°

• R type insert (mm)

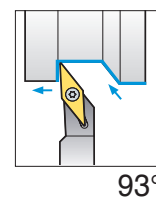
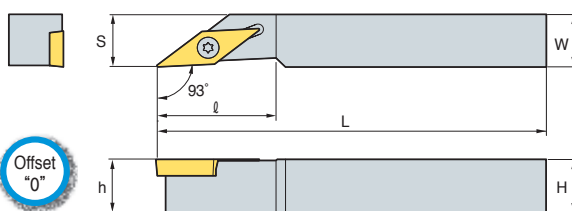
Designation	H	W	L	S	h	ℓ	Insert	Screw	Wrench
SVAPR/L 0808-X11A	8	8	120	8	8	22	VP□□ T1103□□	FTKA02565	TW07P
1010-X11A	10	10	120	10	10	22			
1212-X11A	12	12	120	12	12	22			
1616-X11A	16	16	120	16	16	24			

➔ Applicable inserts B100

SVJBR/L



VB□□



93°

• R type insert (mm)

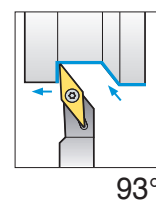
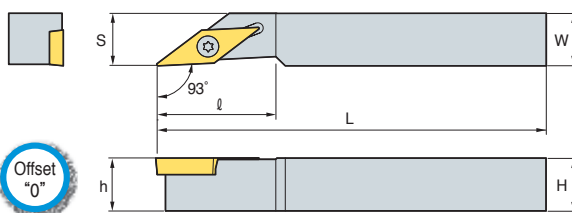
Designation	H	W	L	S	h	ℓ	Insert	Screw	Wrench
SVJBR/L 1010-X11A	10	10	120	10	10	22	VB□□ T1103□□	FTKA02565	TW07P
1212-X11A	12	12	120	12	12	22			
1616-X11A	16	16	120	16	16	24			

➔ Applicable inserts B94~B96, B108

SVJCR/L



VC□□



93°

• R type insert (mm)

Designation	H	W	L	S	h	ℓ	Insert	Screw	Wrench
SVJCR/L 1010-X11A	10	10	120	10	10	22	VC□□ T1103□□	FTKA02565	TW07P
1212-X11A	12	12	120	12	12	22			
1616-X11A	16	16	120	16	16	24			
0810-X12A	8	10	120	10	8	26	VC□□ T1203□□	FTKA02565	TW07P
1010-X12A	10	10	120	10	10	26			
1212-X12A	12	12	120	12	12	26			
1616-X12A	16	16	120	16	16	26			
SVJCR/L 0810-X12C	8	10	120	10	8	26	VC□□ X1203□□	FTKA02565	TW07P
1010-X12C	10	10	120	10	10	26			
1212-X12C	12	12	120	12	12	26			
1616-X12C	16	16	120	16	16	26			

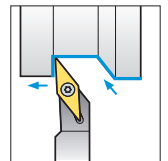
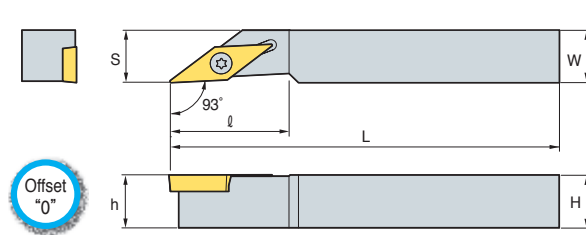
➔ Applicable inserts B97~B99, B109

B Auto Tools (ISO type)

SVJPR/L



VP□T



93°

• R type insert (mm)

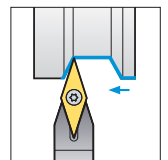
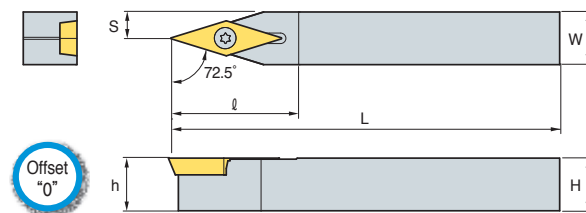
Designation	H	W	L	S	h	ℓ	Insert	Screw	Wrench
SVJPR/L 0810-X11A	8	10	120	8	10	22	VP□T1103□□	FTKA02565	TW07P
1010-X11A	10	10	120	10	10	22			
1212-X11A	12	12	120	12	12	22			
1616-X11A	16	16	120	16	16	24			

↻ Applicable inserts B100

SVVPN



VP□T



72.5°

• R type insert (mm)

Designation	H	W	L	S	h	ℓ	Insert	Screw	Wrench
SVVPN 0808-X11A	8	8	120	4	8	24	VP□T1103□□	FTKA02565	TW07P
1010-X11A	10	10	120	5	10	24			
1212-X11A	12	12	120	6	12	24			
1616-X11A	16	16	120	8	16	28			

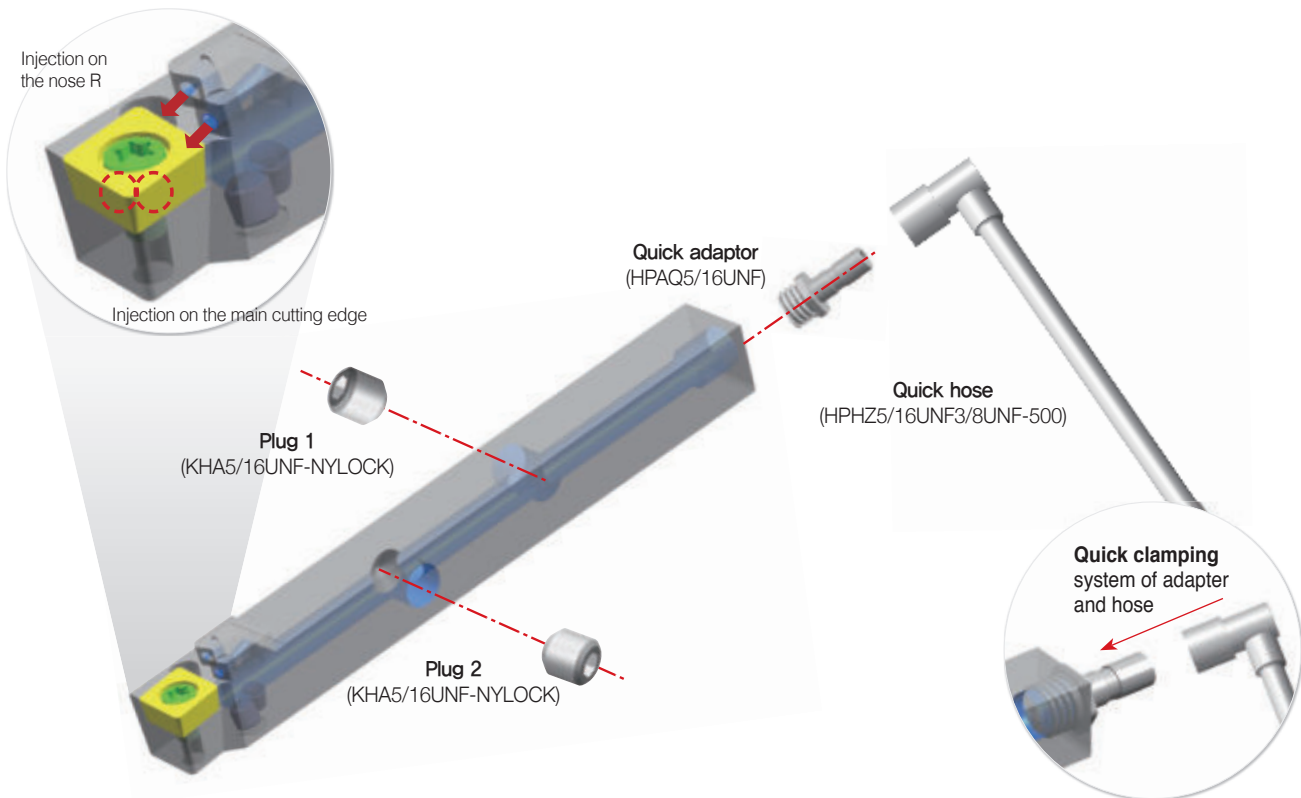
↻ Applicable inserts B100



Auto Tools (KHP Coolant)




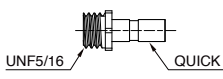
- KORLOY High pressure coolant for high productivity of automatic lathe
- High pressure coolant holder for high productivity of precise parts machining on automatic lathe
- Improved cooling and chip control due to injecting coolant through two holes to the main cutting edge and nose R concentrically
- Two holes with different injection angles each other increase chip control
- Easy clamping system of quick hose adapter and quick hose provides convenient using

Structure of holder



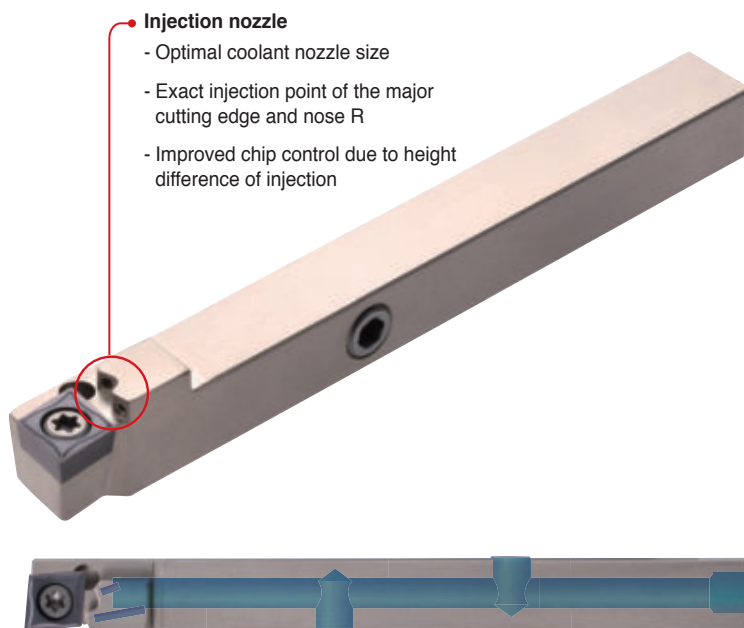
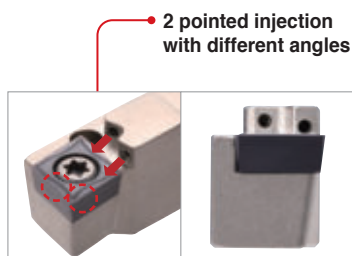
※ Quick adaptor and quick hose are sold separately

Parts

	Shape	Configuration	Length	Q clamping dimensions	S clamping dimensions
Quick to straight	HPHZ5/16UNF3/8UNF-500 		500 mm	UNF5/16	-
Quick adaptor	HPAQ5/16UNF 		18.5 mm	UNF5/16	

B Auto Tools (KHP Coolant)

Features



- Injection nozzle**
- Optimal coolant nozzle size
 - Exact injection point of the major cutting edge and nose R
 - Improved chip control due to height difference of injection

Max 300 bar		
Workpiece	The minimum pressure	The maximum pressure
P	100	300
M	120	
K	110	
N	100	
S	120	

Parts

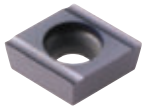
Devision	Designation	Shape	
Adaptor	HPA3/8UNF1/8PF		
Blank	HPB1/8PF		
Quick adaptor	HPAQ5/16UNF		

High pressure hose

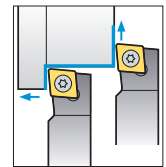
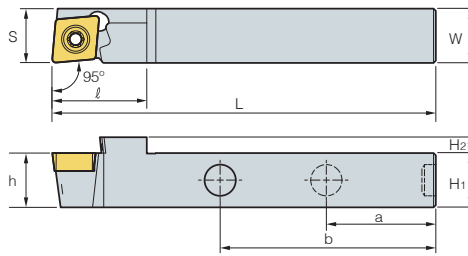
	Shape	length	Q clamping dimensions	S clamping dimensions
Quick to straight (HPHZ5/16UNF3/8UNF-500)		500 mm	UNF5/16	-



SCLCR/L



CC□T



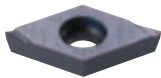
95°

• R type insert (mm)

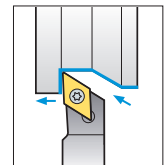
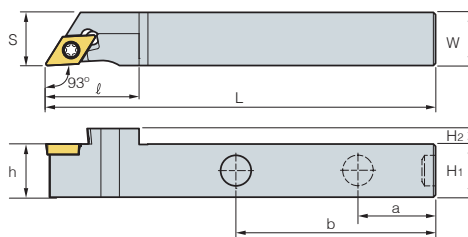
Designation	H ₁	H ₂	W	L	S	h	ℓ	a	b	Insert	Screw	Plug	Wrench
SCLCR/L 1212-X09A-KHP	12	3.5	12	120	12	12	21	40	70	CC□T09T3□□	FTKA0410	KHA0404-NYLOCK	TW15P

➔ Applicable inserts B66-69, B91

SDJCR/L



DC□T



93°

• R type insert (mm)

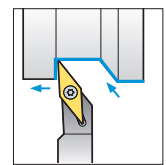
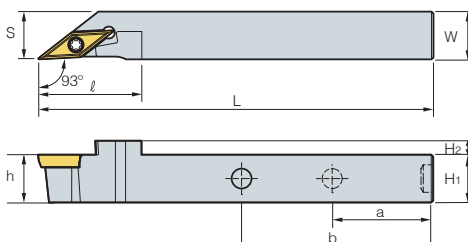
Designation	H ₁	H ₂	W	L	S	h	ℓ	a	b	Insert	Screw	Plug	Wrench
SDJCR/L 1212-X07A-KHP	12	3.5	12	120	12	12	21	40	70	DC□T0702□□	FTKA02565	KHA0404-NYLOCK	TW07P
1212-X11A-KHP	12	3.5	12	120	14	12	29.8	40	70	DC□T11T3□□	FTKA0408	KHA0404-NYLOCK	TW15P

➔ Applicable inserts B71-73, B92

SVJCR/L



VC□□



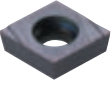
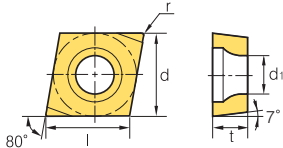
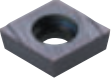
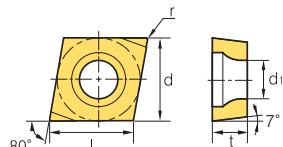

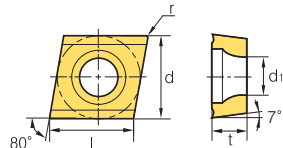
93°

• R type insert (mm)

Designation	H ₁	H ₂	W	L	S	h	ℓ	a	b	Insert	Screw	Plug	Wrench
SVJCR/L 1212-X11A-KHP	12	3.5	12	120	12	12	26	40	70	VC□T1103□□	FTKA02565	KHA0404-NYLOCK	TW07P
1212-X12A-KHP	12	3.5	12	120	12	12	26	40	70	VC□□1203□□	FTKA02565	KHA0404-NYLOCK	TW07P

➔ Applicable inserts B86-B87, B97


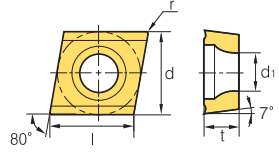

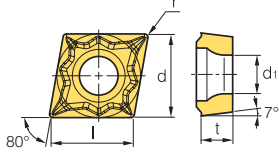

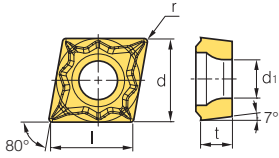
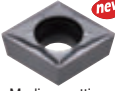
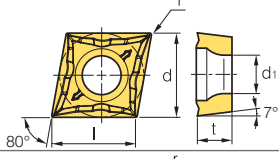
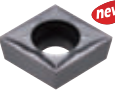
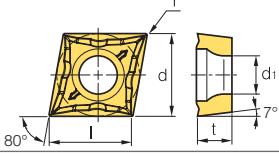
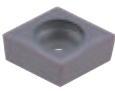
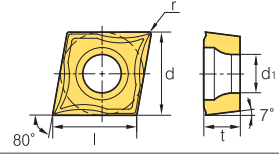

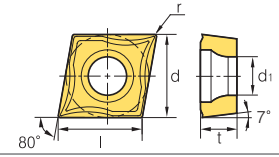
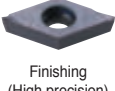
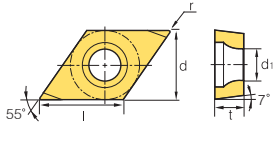
Insert

Picture	Designation	Coated				Uncoated	Dimensions (mm)					Configuration
		PC5300	PC8105	PC8110	PC8115	H01	l	d	t	r	d ₁	
 <p>CCGT-KF Finishing (High precision)</p>	0301003R-KF	●		●			3.6	3.5	1.39	0.03	1.9	
	030101R-KF	●		●			3.5	3.5	1.39	0.10	1.9	
	030102R-KF	●		●			3.5	3.5	1.39	0.20	1.9	
	030104R-KF	●		●			3.5	3.5	1.39	0.40	1.9	
	0401003R-KF	●		●			4.4	4.3	1.79	0.03	2.3	
	040101R-KF	●		●			4.4	4.3	1.79	0.10	2.3	
	040102R-KF	●		●			4.3	4.3	1.79	0.20	2.3	
	040104R-KF	●		●			4.3	4.3	1.79	0.40	2.3	
	0602003R-KF						6.6	6.35	2.38	0.03	2.8	
	060201R-KF						6.4	6.35	2.38	0.10	2.8	
	060202R-KF						6.2	6.35	2.38	0.20	2.8	
	09T3003R-KF						9.8	9.525	3.97	0.03	4.4	
	09T301R-KF						9.6	9.525	3.97	0.10	4.4	
	09T302R-KF						9.2	9.525	3.97	0.20	4.4	
	0301003L-KF	●		●			3.6	3.5	1.39	0.03	1.9	
	030101L-KF	●		●			3.5	3.5	1.39	0.10	1.9	
	030102L-KF	●		●			3.5	3.5	1.39	0.20	1.9	
	030104L-KF	●		●			3.5	3.5	1.39	0.40	1.9	
	0401003L-KF	●		●			4.4	4.3	1.79	0.03	2.3	
	040101L-KF	●		●			4.4	4.3	1.79	0.10	2.3	
	040102L-KF	●		●			4.3	4.3	1.79	0.20	2.3	
	040104L-KF	●		●			4.3	4.3	1.79	0.40	2.3	
	0602003L-KF						6.6	6.35	2.38	0.03	2.8	
	060201L-KF						6.4	6.35	2.38	0.10	2.8	
	060202L-KF						6.2	6.35	2.38	0.20	2.8	
	09T3003L-KF						9.8	9.525	3.97	0.03	4.4	
	09T301L-KF						9.6	9.525	3.97	0.10	4.4	
	09T302L-KF						9.2	9.525	3.97	0.20	4.4	
 <p>CCET-KF Finishing (Ultra high precision)</p>	0602005MFR-KF	●		●			6.6	6.35	2.38	<0.05	2.8	
	060201MFR-KF	●		●			6.4	6.35	2.38	<0.10	2.8	
	060202MFR-KF	●		●			6.2	6.35	2.38	<0.20	2.8	
	09T3005MFR-KF	●		●			9.8	9.525	3.97	<0.05	4.4	
	09T301MFR-KF	●		●			9.6	9.525	3.97	<0.10	4.4	
	09T302MFR-KF	●		●			9.2	9.525	3.97	<0.20	4.4	
	0602005MFL-KF	●		●			6.6	6.35	2.38	<0.05	2.8	
	060201MFL-KF	●		●			6.4	6.35	2.38	<0.10	2.8	
	060202MFL-KF	●		●			6.2	6.35	2.38	<0.20	2.8	
	09T3005MFL-KF	●		●			9.8	9.525	3.97	<0.05	4.4	
09T301MFL-KF	●		●			9.6	9.525	3.97	<0.10	4.4		
09T302MFL-KF	●		●			9.2	9.525	3.97	<0.20	4.4		
 <p>CCGT-KM Medium to finishing (High precision)</p>	0602003R-KM	●		●			6.6	6.35	2.38	0.03	2.8	
	060201R-KM	●		●			6.4	6.35	2.38	0.10	2.8	
	060202R-KM	●		●			6.2	6.35	2.38	0.20	2.8	
	060204R-KM	●		●			6.2	6.35	2.38	0.40	2.8	
	09T3003R-KM	●		●			9.8	9.525	3.97	0.03	4.4	
	09T301R-KM	●		●			9.6	9.525	3.97	0.10	4.4	
	09T302R-KM	●		●			9.2	9.525	3.97	0.20	4.4	
	09T304R-KM	●		●			9.2	9.525	3.97	0.40	4.4	
	0602003L-KM	●		●			6.6	6.35	2.38	0.03	2.8	
	060201L-KM	●		●			6.4	6.35	2.38	0.10	2.8	
	060202L-KM	●		●			6.2	6.35	2.38	0.20	2.8	
	060204L-KM	●		●			6.2	6.35	2.38	0.40	2.8	
	09T3003L-KM	●		●			9.8	9.525	3.97	0.03	4.4	
	09T301L-KM	●		●			9.6	9.525	3.97	0.10	4.4	
09T302L-KM	●		●			9.2	9.525	3.97	0.20	4.4		
09T304L-KM	●		●			9.2	9.525	3.97	0.40	4.4		

● : Stock item




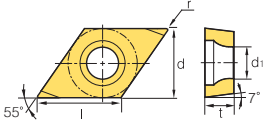

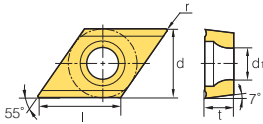

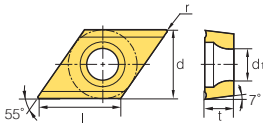

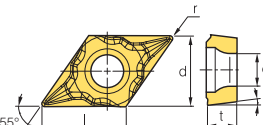

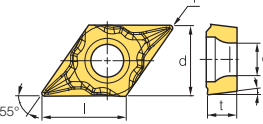
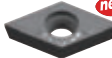
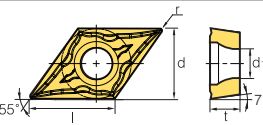

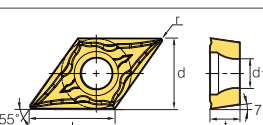
Insert

Picture	Designation	Coated				Uncoated H01	Dimensions (mm)					Configuration
		PC5300	PC8105	PC8110	PC8115		l	d	t	r	d ₁	
CCET-KM  Medium to finishing (Ultra high precision)	0602005MFR-KM	●		●			6.6	6.35	2.38	< 0.05	2.8	
	060201MFR-KM	●		●			6.4	6.35	2.38	< 0.10	2.8	
	060202MFR-KM	●		●			6.2	6.35	2.38	< 0.20	2.8	
	09T3005MFR-KM	●		●			9.8	9.525	3.97	< 0.05	4.4	
	09T301MFR-KM	●		●			9.6	9.525	3.97	< 0.10	4.4	
	09T302MFR-KM	●		●			9.2	9.525	3.97	< 0.20	4.4	
	0602005MFL-KM	●		●			6.6	6.35	2.38	< 0.05	2.8	
	060201MFL-KM	●		●			6.4	6.35	2.38	< 0.10	2.8	
	060202MFL-KM	●		●			6.2	6.35	2.38	< 0.20	2.8	
	09T3005MFL-KM	●		●			9.8	9.525	3.97	< 0.05	4.4	
09T301MFL-KM	●		●			9.6	9.525	3.97	< 0.10	4.4		
09T302MFL-KM	●		●			9.2	9.525	3.97	< 0.20	4.4		
CCGT-FS  Finishing (High precision)	060201-FS	●		●			6.3	6.35	2.38	0.10	2.8	
	060202-FS	●		●			6.2	6.35	2.38	0.20	2.8	
	060204-FS	●		●			6.0	6.35	2.38	0.40	2.8	
	09T301-FS	●		●			9.8	9.525	3.97	0.10	4.4	
	09T302-FS	●		●			9.6	9.525	3.97	0.20	4.4	
	09T304-FS	●		●			9.2	9.525	3.97	0.40	4.4	
CCGT-FS  Finishing (Ultra high precision)	060201MFN-FS	●		●			6.3	6.35	2.38	< 0.10	2.8	
	060202MFN-FS	●		●			6.2	6.35	2.38	< 0.20	2.8	
	060204MFN-FS	●		●			6.0	6.35	2.38	< 0.40	2.8	
	09T301MFN-FS	●		●			9.8	9.525	3.97	< 0.10	4.4	
	09T302MFN-FS	●		●			9.6	9.525	3.97	< 0.20	4.4	
	09T304MFN-FS	●		●			9.2	9.525	3.97	< 0.40	4.4	
CCGT-MS  Medium cutting (High precision)	09T301-MS	●		●			9.8	9.525	3.97	0.10	4.4	
	09T302-MS	●		●			9.6	9.525	3.97	0.20	4.4	
	09T304-MS	●		●			9.2	9.525	3.97	0.40	4.4	
CCGT-MS  Medium cutting (Ultra high precision)	09T301MFN-MS	●		●			9.8	9.525	3.97	< 0.10	4.4	
	09T302MFN-MS	●		●			9.6	9.525	3.97	< 0.20	4.4	
	09T304MFN-MS	●		●			9.2	9.525	3.97	< 0.40	4.4	
CCGT-VP1  Finishing (High precision)	60201-VP1	●	●	●	●	●	6.6	6.35	2.38	0.10	2.8	
	60202-VP1	●	●	●	●	●	6.4	6.35	2.38	0.20	2.8	
	60204-VP1	●	●	●	●	●	6.2	6.35	2.38	0.40	2.8	
	09T301-VP1	●	●	●	●	●	9.8	9.525	3.97	0.10	4.4	
	09T302-VP1	●	●	●	●	●	9.6	9.525	3.97	0.20	4.4	
	09T304-VP1	●	●	●	●	●	9.2	9.525	3.97	0.40	4.4	
CCGT-VP1  Finishing (Ultra high precision)	060201MFN-VP1	●		●			6.6	6.35	2.38	< 0.10	2.8	
	060202MFN-VP1	●		●			6.4	6.35	2.38	< 0.20	2.8	
	060204MFN-VP1	●		●			6.2	6.35	2.38	< 0.40	2.8	
	09T301MFN-VP1	●		●			9.8	9.525	3.97	< 0.10	4.4	
	09T302MFN-VP1	●		●			9.6	9.525	3.97	< 0.20	4.4	
	09T304MFN-VP1	●		●			9.2	9.525	3.97	< 0.40	4.4	
DCGT-KF  Finishing (High precision)	0702003R-KF	●		●			7.8	6.35	2.38	0.03	2.8	
	070201R-KF	●		●			7.8	6.35	2.38	0.10	2.8	
	070202R-KF	●		●			7.8	6.35	2.38	0.20	2.8	
	070204R-KF	●		●			7.8	6.35	2.38	0.40	2.8	
	11T3003R-KF	●		●			11.6	9.525	3.97	0.03	4.4	
	11T301R-KF	●		●			11.6	9.525	3.97	0.10	4.4	
	11T302R-KF	●		●			11.6	9.525	3.97	0.20	4.4	
	11T304R-KF	●		●			11.6	9.525	3.97	0.40	4.4	
	0702003L-KF	●		●			7.8	6.35	2.38	0.03	2.8	
	070201L-KF	●		●			7.8	6.35	2.38	0.10	2.8	
	070202L-KF	●		●			7.8	6.35	2.38	0.20	2.8	
	070204L-KF	●		●			7.8	6.35	2.38	0.40	2.8	
	11T3003L-KF	●		●			11.6	9.525	3.97	0.03	4.4	
	11T301L-KF	●		●			11.6	9.525	3.97	0.10	4.4	
11T302L-KF	●		●			11.6	9.525	3.97	0.20	4.4		
11T304L-KF	●		●			11.6	9.525	3.97	0.40	4.4		

● : Stock item




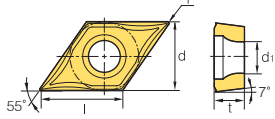

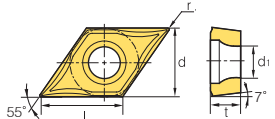

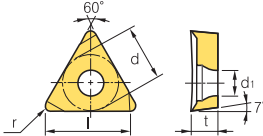

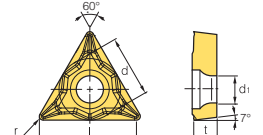

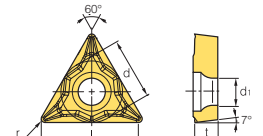

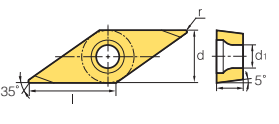

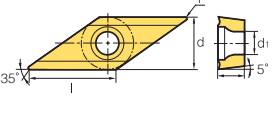

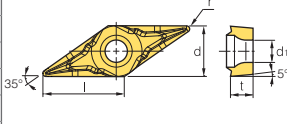

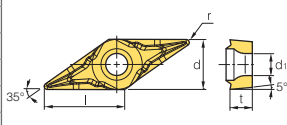

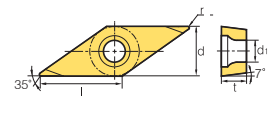
Insert

Picture	Designation	Coated				Uncoated	Dimensions (mm)					Configuration
		PC5300	PC8105	PC8110	PC8115	H01	l	d	t	r	d ₁	
 <p>DCET-KF Finishing (Ultra high precision)</p>	0702005MFR-KF	●		●			7.8	6.35	2.38	<0.05	2.8	
	070201MFR-KF	●		●			7.8	6.35	2.38	<0.10	2.8	
	070202MFR-KF	●		●			7.8	6.35	2.38	<0.20	2.8	
	11T3005MFR-KF	●		●			11.6	9.525	3.97	<0.05	4.4	
	11T301MFR-KF	●		●			11.6	9.525	3.97	<0.10	4.4	
	11T302MFR-KF	●		●			11.6	9.525	3.97	<0.20	4.4	
	0702005MFL-KF	●		●			7.8	6.35	2.38	<0.05	2.8	
	070201MFL-KF	●		●			7.8	6.35	2.38	<0.10	2.8	
	070202MFL-KF	●		●			7.8	6.35	2.38	<0.20	2.8	
	11T3005MFL-KF	●		●			11.6	9.525	3.97	<0.05	4.4	
	11T301MFL-KF	●		●			11.6	9.525	3.97	<0.10	4.4	
11T302MFL-KF	●		●			11.6	9.525	3.97	<0.20	4.4		
 <p>DCGT-KM Medium to finishing (High precision)</p>	0702003R-KM	●		●			7.8	6.35	2.38	0.03	2.8	
	070201R-KM	●		●			7.8	6.35	2.38	0.10	2.8	
	070202R-KM	●		●			7.8	6.35	2.38	0.20	2.8	
	070204R-KM	●		●			7.8	6.35	2.38	0.40	2.8	
	11T3003R-KM	●		●			11.6	9.525	3.97	0.03	4.4	
	11T301R-KM	●		●			11.6	9.525	3.97	0.10	4.4	
	11T302R-KM	●		●			11.6	9.525	3.97	0.20	4.4	
	11T304R-KM	●		●			11.6	9.525	3.97	0.40	4.4	
	0702003L-KM	●		●			7.8	6.35	2.38	0.03	2.8	
	070201L-KM	●		●			7.8	6.35	2.38	0.10	2.8	
	070202L-KM	●		●			7.8	6.35	2.38	0.20	2.8	
	070204L-KM	●		●			7.8	6.35	2.38	0.40	2.8	
	11T3003L-KM	●		●			11.6	9.525	3.97	0.03	4.4	
	11T301L-KM	●		●			11.6	9.525	3.97	0.10	4.4	
11T302L-KM	●		●			11.6	9.525	3.97	0.20	4.4		
11T304L-KM	●		●			11.6	9.525	3.97	0.40	4.4		
 <p>DCET-KM Medium to finishing (Ultra high precision)</p>	0702005MFR-KM	●		●			7.8	6.35	2.38	<0.05	2.8	
	070201MFR-KM	●		●			7.8	6.35	2.38	<0.10	2.8	
	070202MFR-KM	●		●			7.8	6.35	2.38	<0.20	2.8	
	11T3005MFR-KM	●		●			11.6	9.525	3.97	<0.05	4.4	
	11T301MFR-KM	●		●			11.6	9.525	3.97	<0.10	4.4	
	11T302MFR-KM	●		●			11.6	9.525	3.97	<0.20	4.4	
	0702005MFL-KM	●		●			7.8	6.35	2.38	<0.05	2.8	
	070201MFL-KM	●		●			7.8	6.35	2.38	<0.10	2.8	
	070202MFL-KM	●		●			7.8	6.35	2.38	<0.20	2.8	
	11T3005MFL-KM	●		●			11.6	9.525	3.97	<0.05	4.4	
	11T301MFL-KM	●		●			11.6	9.525	3.97	<0.10	4.4	
11T302MFL-KM	●		●			11.6	9.525	3.97	<0.20	4.4		
 <p>DCGT-FS Finishing (High precision)</p>	070201-FS	●		●			7.6	6.35	2.38	0.10	2.8	
	070202-FS	●		●			7.5	6.35	2.38	0.20	2.8	
	11T301-FS	●		●			11.6	9.525	3.97	0.10	4.4	
	11T302-FS	●		●			11.6	9.525	3.97	0.20	4.4	
	11T304-FS	●		●			11.6	9.525	3.97	0.40	4.4	
	11T308-FS	●		●			11.6	9.525	3.97	0.80	4.4	
 <p>DCGT-FS Finishing (Ultra high precision)</p>	070201MFN-FS						7.6	6.35	2.38	<0.10	2.8	
	070202MFN-FS						7.5	6.35	2.38	<0.20	2.8	
	11T301MFN-FS						11.6	9.525	3.97	<0.10	4.4	
	11T302MFN-FS						11.4	9.525	3.97	<0.20	4.4	
	11T304MFN-FS						11.2	9.525	3.97	<0.40	4.4	
	11T308MFN-FS						11.0	9.525	3.97	<0.80	4.4	
 <p>DCGT-MS Medium cutting (High precision)</p>	11T301-MS	●		●			11.6	9.525	3.97	0.10	4.4	
	11T302-MS	●		●			11.6	9.525	3.97	0.20	4.4	
	11T304-MS	●		●			11.6	9.525	3.97	0.40	4.4	
 <p>DCGT-MS Medium cutting (Ultra high precision)</p>	11T301MFN-MS	●		●			11.6	9.525	3.97	<0.10	4.4	
	11T302MFN-MS	●		●			11.6	9.525	3.97	<0.20	4.4	
	11T304MFN-MS	●		●			11.6	9.525	3.97	<0.40	4.4	

● : Stock item




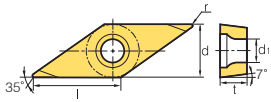

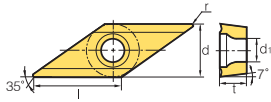

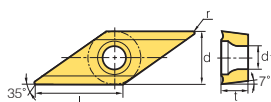

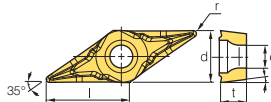

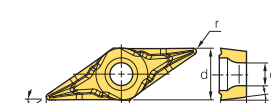

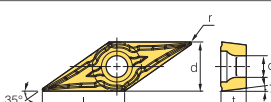

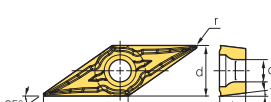

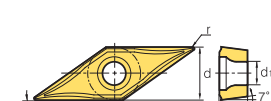

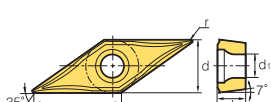

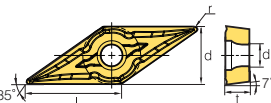

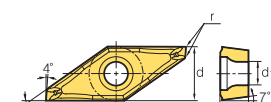
Insert

Picture	Designation	Coated				Uncoated H01	Dimensions (mm)					Configuration
		PC5300	PC8105	PC8110	PC8115		l	d	t	r	d ₁	
 Finishing (High precision)	070201-VP1	●	●	●	●	●	7.8	6.35	2.38	0.10	2.8	
	070202-VP1	●	●	●	●	●	7.8	6.35	2.38	0.20	2.8	
	070204-VP1	●	●	●	●	●	7.8	6.35	2.38	0.40	2.8	
	11T301-VP1	●	●	●	●	●	11.6	9.525	3.97	0.10	4.4	
	11T302-VP1	●	●	●	●	●	11.6	9.525	3.97	0.20	4.4	
	11T304-VP1	●	●	●	●	●	11.6	9.525	3.97	0.40	4.4	
 Finishing (Ultra high precision)	070201MFN-VP1	●	●	●	●	●	7.8	6.35	2.38	< 0.10	2.8	
	070202MFN-VP1	●	●	●	●	●	7.8	6.35	2.38	< 0.20	2.8	
	070204MFN-VP1	●	●	●	●	●	7.8	6.35	2.38	< 0.40	2.8	
	11T301MFN-VP1	●	●	●	●	●	11.6	9.525	3.97	< 0.10	4.4	
	11T302MFN-VP1	●	●	●	●	●	11.6	9.525	3.97	< 0.20	4.4	
	11T304MFN-VP1	●	●	●	●	●	11.6	9.525	3.97	< 0.40	4.4	
 Finishing (High precision)	0802003R-KF	●	●	●	●	●	8.15	4.76	2.38	0.03	2.38	
	080201R-KF	●	●	●	●	●	8.0	4.76	2.38	0.10	2.38	
	080202R-KF	●	●	●	●	●	7.7	4.76	2.38	0.20	2.38	
	08020003L-KF	●	●	●	●	●	8.15	4.76	2.38	0.03	2.38	
	080201L-KF	●	●	●	●	●	8.0	4.76	2.38	0.10	2.38	
	080202L-KF	●	●	●	●	●	7.7	4.76	2.38	0.20	2.38	
 Finishing (High precision)	110201-FS	●	●	●	●	●	9.3	6.35	2.38	0.10	2.8	
	110202-FS	●	●	●	●	●	9.1	6.35	2.38	0.20	2.8	
	110204-FS	●	●	●	●	●	8.6	6.35	2.38	0.40	2.8	
 Finishing (Ultra high precision)	110201MFN-FS	●	●	●	●	●	9.3	6.35	3.18	< 0.10	3.4	
	110202MFN-FS	●	●	●	●	●	9.1	6.35	3.18	< 0.20	3.4	
	110204MFN-FS	●	●	●	●	●	8.6	6.35	3.18	< 0.40	3.4	
 Finishing (High precision)	1103003R-KF	●	●	●	●	●	7.8	6.35	2.38	0.03	2.8	
	110301R-KF	●	●	●	●	●	7.8	6.35	2.38	0.10	2.8	
	110302R-KF	●	●	●	●	●	7.8	6.35	2.38	0.20	2.8	
	1103003L-KF	●	●	●	●	●	11.6	9.525	3.97	0.03	4.4	
	110301L-KF	●	●	●	●	●	11.6	9.525	3.97	0.10	4.4	
	110302L-KF	●	●	●	●	●	11.6	9.525	3.97	0.20	4.4	
 Medium to finishing (High precision)	1103003R-KM	●	●	●	●	●	7.8	6.35	2.38	0.03	2.8	
	110301R-KM	●	●	●	●	●	7.8	6.35	2.38	0.10	2.8	
	110302R-KM	●	●	●	●	●	7.8	6.35	2.38	0.20	2.8	
	1103003L-KM	●	●	●	●	●	11.6	9.525	3.97	0.03	4.4	
	110301L-KM	●	●	●	●	●	11.6	9.525	3.97	0.10	4.4	
	110302L-KM	●	●	●	●	●	11.6	9.525	3.97	0.20	4.4	
 Finishing (High precision)	110301-FS	●	●	●	●	●	11.0	6.35	3.18	0.10	2.8	
	110302-FS	●	●	●	●	●	11.0	6.35	3.18	0.20	2.8	
	110304-FS	●	●	●	●	●	11.0	6.35	3.18	0.40	2.8	
	160401-FS	●	●	●	●	●	16.3	9.525	4.76	0.10	4.4	
	160402-FS	●	●	●	●	●	16.1	9.525	4.76	0.20	4.4	
	160404-FS	●	●	●	●	●	15.7	9.525	4.76	0.40	4.4	
 Finishing (Ultra high precision)	110301MFN-FS	●	●	●	●	●	10.8	6.35	3.18	< 0.10	2.8	
	110302MFN-FS	●	●	●	●	●	10.6	6.35	3.18	< 0.20	2.8	
	110304MFN-FS	●	●	●	●	●	11.4	6.35	3.18	< 0.40	2.8	
	160401MFN-FS	●	●	●	●	●	16.3	9.525	4.76	< 0.10	4.4	
	160402MFN-FS	●	●	●	●	●	16.1	9.525	4.76	< 0.20	4.4	
	160404MFN-FS	●	●	●	●	●	15.7	9.525	4.76	< 0.40	4.4	
 Finishing (High precision)	1103003R-KF	●	●	●	●	●	11.0	6.35	3.18	0.03	2.8	
	110301R-KF	●	●	●	●	●	11.0	6.35	3.18	0.10	2.8	
	110302R-KF	●	●	●	●	●	11.0	6.35	3.18	0.20	2.8	
	1103003L-KF	●	●	●	●	●	11.0	6.35	3.18	0.03	2.8	
	110301L-KF	●	●	●	●	●	11.0	6.35	3.18	0.10	2.8	
	110302L-KF	●	●	●	●	●	11.0	6.35	3.18	0.20	2.8	

● : Stock item




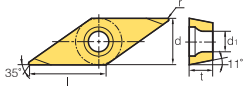

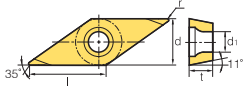

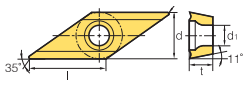

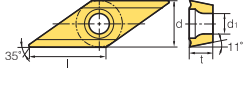

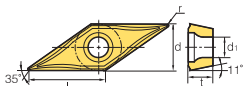

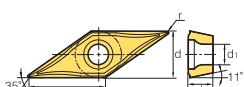
Insert

Picture	Designation	Coated				Uncoated	Dimensions (mm)					Configuration
		PC5300	PC8105	PC8110	PC8115	H01	l	d	t	r	d ₁	
VCET-KF  Finishing (Ultra high precision)	1103005MFR-KF	●		●			11.0	6.35	3.18	< 0.05	2.8	
	110301MFR-KF	●		●			11.0	6.35	3.18	< 0.10	2.8	
	110302MFR-KF	●		●			11.0	6.35	3.18	< 0.20	2.8	
	1103005MFL-KF	●		●			11.0	6.35	3.18	< 0.05	2.8	
	110301MFL-KF	●		●			11.0	6.35	3.18	< 0.10	2.8	
	110302MFL-KF	●		●			11.0	6.35	3.18	< 0.20	2.8	
VCGT-KM  Medium to finishing (High precision)	1103003R-KM						11.0	6.35	3.18	0.03	2.8	
	110301R-KM						11.0	6.35	3.18	0.10	2.8	
	110302R-KM						11.0	6.35	3.18	0.20	2.8	
	1103003L-KM						11.0	6.35	3.18	0.03	2.8	
	110301L-KM						11.0	6.35	3.18	0.10	2.8	
	110302L-KM						11.0	6.35	3.18	0.20	2.8	
VCET-KM  Medium to finishing (Ultra high precision)	1103005MFR-KM	●		●			11.0	6.35	3.18	< 0.05	2.8	
	110301MFR-KM	●		●			11.0	6.35	3.18	< 0.10	2.8	
	110302MFR-KM	●		●			11.0	6.35	3.18	< 0.20	2.8	
	3005MFL-KM	●		●			11.0	6.35	3.18	< 0.05	2.8	
	301MFL-KM	●		●			11.0	6.35	3.18	< 0.10	2.8	
	302MFL-KM	●		●			11.0	6.35	3.18	< 0.20	2.8	
VCGT-FS  Finishing (High precision)	110301-FS	●		●			11.0	6.35	3.18	0.10	2.8	
	110302-FS	●		●			11.0	6.35	3.18	0.20	2.8	
	110304-FS	●		●			11.0	6.35	3.18	0.40	2.8	
	160401-FS	●		●			16.3	9.525	4.76	0.10	4.4	
	160402-FS	●		●			16.1	9.525	4.76	0.20	4.4	
	160404-FS	●		●			15.7	9.525	4.76	0.40	4.4	
VCGT-FS  Finishing (Ultra high precision)	110301MFN-FS						10.8	6.35	3.18	< 0.10	2.8	
	110302MFN-FS						10.6	6.35	3.18	< 0.20	2.8	
	110304MFN-FS						11.4	6.35	3.18	< 0.40	2.8	
	160401MFN-FS						16.3	9.525	4.76	< 0.10	4.4	
	160402MFN-FS						16.1	9.525	4.76	< 0.20	4.4	
	160404MFN-FS						15.7	9.525	4.76	< 0.40	4.4	
VCGT-MS  Medium cutting (High precision)	110301-MS	●		●			10.8	6.35	3.18	0.10	2.8	
	110302-MS	●		●			10.6	6.35	3.18	0.20	2.8	
	110304-MS	●		●			11.4	6.35	3.18	0.40	2.8	
VCGT-MS  Medium cutting (Ultra high precision)	11T301MFN-MS	●		●			10.8	6.35	3.18	< 0.10	2.8	
	11T302MFN-MS	●		●			10.6	6.35	3.18	< 0.20	2.8	
	11T304MFN-MS	●		●			11.4	6.35	3.18	< 0.40	2.8	
VCGT-VP1  Finishing (High precision)	110301-VP1	●	●	●	●	●	11.0	6.35	3.18	0.10	2.8	
	110302-VP1	●	●	●	●	●	11.0	6.35	3.18	0.20	2.8	
	110304-VP1	●	●	●	●	●	11.0	6.35	3.18	0.40	2.8	
VCGT-VP1  Finishing (Ultra high precision)	110301MFN-VP1	●		●			11.0	6.35	3.18	< 0.10	2.8	
	110302MFN-VP1	●		●			11.0	6.35	3.18	< 0.20	2.8	
	110304MFN-VP1	●		●			11.0	6.35	3.18	< 0.40	2.8	
VCGT-MS  Medium cutting (Ultra high precision)	1203008FN-MS	●		●			11.0	7.50	3.00	< 0.08	2.8	
	120301FN-MS	●		●			11.0	7.50	3.00	< 0.10	2.8	
	120302FN-MS	●		●			11.0	7.50	3.00	< 0.20	2.8	
	120304FN-MS	●		●			11.0	7.50	3.00	< 0.40	2.8	
VCGX-VP1  Finishing (Ultra high precision) Chamfer type	120300MFR-VP1	●		●			11.0	7.50	3.18	< 0.00	2.8	
	120301MFR-VP1	●		●			11.0	7.50	3.18	< 0.10	2.8	
	120302MFR-VP1	●		●			11.0	7.50	3.18	< 0.20	2.8	
	120304MFR-VP1	●		●			11.0	7.50	3.18	< 0.40	2.8	
	120308MFR-VP1	●		●			11.0	7.50	3.18	< 0.80	2.8	

● : Stock item



Insert

Picture	Designation	Coated				Uncoated H01	Dimensions (mm)					Configuration
		PC5300	PC8105	PC8110	PC8115		l	d	t	r	d ₁	
 <p>VPET-KF Finishing (High precision)</p>	080201R-KF	●		●			8.0	4.76	2.38	0.10	2.3	
	080202R-KF	●		●			8.0	4.76	2.38	0.20	2.3	
	1103003R-KF	●		●			11.0	6.35	3.18	0.03	2.8	
	110301R-KF	●		●			11.0	6.35	3.18	0.10	2.8	
	110302R-KF	●		●			11.0	6.35	3.18	0.20	2.8	
	080201L-KF	●		●			8.0	4.76	2.38	0.10	2.3	
	080202L-KF	●		●			8.0	4.76	2.38	0.20	2.3	
	1103003L-KF	●		●			11.0	6.35	3.18	0.03	2.8	
	110301L-KF	●		●			11.0	6.35	3.18	0.10	2.8	
110302L-KF	●		●			11.0	6.35	3.18	0.20	2.8		
 <p>VPET-KM Finishing (Ultra high precision)</p>	0802005MFR-KF	●		●			8.0	6.35	2.38	<0.05	2.3	
	080201MFR-KF	●		●			8.0	6.35	2.38	<0.10	2.3	
	080202MFR-KF	●		●			8.0	6.35	2.38	<0.20	2.3	
	0802005MFL-KF	●		●			8.0	6.35	2.38	<0.05	2.3	
	080201MFL-KF	●		●			8.0	6.35	2.38	<0.10	2.3	
	080202MFL-KF	●		●			8.0	6.35	2.38	<0.20	2.3	
 <p>VPGT-KM Medium to finishing (High precision)</p>	080201R-KM	●		●			8.0	4.76	2.38	0.10	2.3	
	080202R-KM	●		●			8.0	4.76	2.38	0.20	2.3	
	1103003R-KM	●		●			11.0	6.35	3.18	0.03	2.8	
	110301R-KM	●		●			11.0	6.35	3.18	0.10	2.8	
	110302R-KM	●		●			11.0	6.35	3.18	0.20	2.8	
	080201L-KM	●		●			8.0	4.76	2.38	0.10	2.3	
	080202L-KM	●		●			8.0	4.76	2.38	0.20	2.3	
	1103003L-KM	●		●			11.0	6.35	3.18	0.03	2.8	
	110301L-KM	●		●			11.0	6.35	3.18	0.10	2.8	
110302L-KM	●		●			11.0	6.35	3.18	0.20	2.8		
 <p>VPET-KM Medium to finishing (Ultra high precision)</p>	0802005MFR-KM	●		●			8.0	6.35	3.18	<0.05	2.8	
	080201MFR-KM	●		●			8.0	6.35	3.18	<0.10	2.8	
	080202MFR-KM	●		●			8.0	6.35	3.18	<0.20	2.8	
	0802005MFL-KM	●		●			8.0	6.35	3.18	<0.05	2.8	
	080201MFL-KM	●		●			8.0	6.35	3.18	<0.10	2.8	
	080202MFL-KM	●		●			8.0	6.35	3.18	<0.20	2.8	
 <p>VPGT-VP1 Medium cutting (High precision)</p>	110301-VP1	●	●	●	●	●	11.0	6.35	3.18	0.10	2.8	
	110302-VP1	●	●	●	●	●	11.0	6.35	3.18	0.20	2.8	
	110304-VP1	●	●	●	●	●	11.0	6.35	3.18	0.40	2.8	
 <p>VPGT-VP1 Medium cutting (Ultra high precision)</p>	110301MFN-VP1	●		●			11.0	6.35	3.18	<0.10	2.8	
	110302MFN-VP1	●		●			11.0	6.35	3.18	<0.20	2.8	
	110304MFN-VP1	●		●			11.0	6.35	3.18	<0.40	2.8	

● : Stock item



B Auto Tools (Blade type)

Auto tools (Blade type)

- Blade insert for automatic lathes
- For external machining of precise small parts
- 4 types - SSB (for back turning), SGB (for grooving), SBT (for threading), SBC (for parting off)
- Convenient use of one holder to all blade inserts
- Exclusive holder for close cutting action to the sub spindle

Code system

• Insert

Turning (Back turning)	SB	B	R	25	005	
	Small blade	Back turning	Hand R: Right L: Left	Length of insert	Nose radius	
Grooving	SB	G	R	25	20	
	Small blade	Grooving	Hand R: Right L: Left	Length of insert	Width of cutting edge	
Threading	SB	T	R	25	60 – N – 010	
	Small blade	Threading	Hand R: Right L: Left	Length of insert	Angle of thread Hand of thread R: Right L: Left N: Neutral	
Parting	SB	C	R	25	20	16 – N
	Small blade	Cut off / Parting	Hand R: Right L: Left	Length of insert	Width of cutting edge	Max. machining diameter Hand of thread R: Right L: Left N: None

• Holder

	SB	H	R	10	10 – K25 – X
	Small blade	Holder	Hand R: Right L: Left	Height of shank	Width of shank
				Length of insert	Sub spindle

Types of blade insert

Possible to apply various types of blade inserts to one holder



SB: For back turning

- Approach angle: 59°
- Max. cutting depth: 4 mm
- Nose R: 0.05, 0.1, 0.2 mm



SGB: For grooving

- Width: 0.5~2.5 mm
- Nose R: 0.05 mm



SBT: For threading

- V profile: 60°
- Pitch: 0.2~1.0 mm
- Nose R: 0.05 mm



SBC: For cut off/Parting

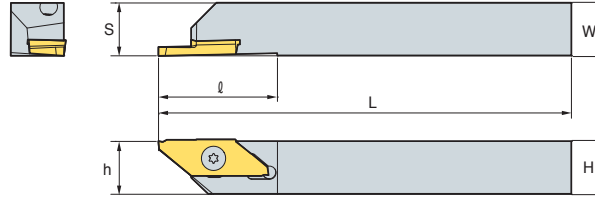
- Cutting width: 0.7~2.0
- DMax.: 16 mm
- Nose R: 0.05 mm



SBHR/L



SBBR SBGR
SBTR SBCR

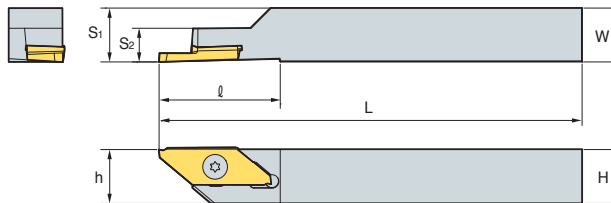


Designation		H	W	L	S	h	l	Insert	Screw	Wrench
SBHR/L	1010-K25	10	10	125	10	10	27	SB□R/L25	FTKA0409S	TW09P
	1212-K25	12	12	125	12	12	27			
	1616-K25	16	16	125	16	16	27			

SBHR/L-X (Sub spindle)



SBBR SBGR
SBTR SBCR



Designation		H	W	L	S1	S2	h	l	Insert	Screw	Wrench
SBHR/L	1010-K25-X	10	10	125	10	7.5	10	27	SB□R/L25	FTKA0407S	TW09P
	1212-K25-X	12	12	125	12	7.5	12	27			

Insert


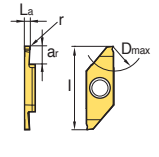
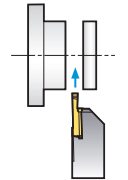
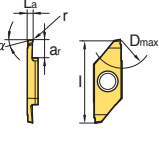
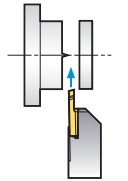
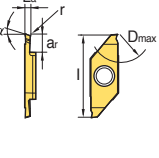
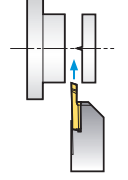
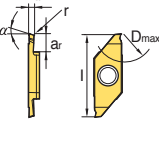
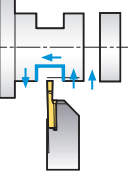
Application	Picture	Designation	Coated				Dimensions (mm)										Configuration	Feed direction	
			PC8110		PC5300		l	α	t	r	La	ar	f	D-MAX	Pitch range				
			R	L	R	L									Min.	Max.			
Back turning		SBBR/L 25005	●	●	●	●	25	59	3.18	0.05	-	-	-	-	-	-	-		
		25010	●	●	●	●	25	59	3.18	0.10	-	-	-	-	-	-	-		
		25020	●	●	●	●	25	59	3.18	0.20	-	-	-	-	-	-	-		
Grooving		SBGR/L 2505	●	●	●	●	25	-	-	0.05	0.5	1.35	-	-	-	-	-		
		2510	●	●	●	●	25	-	-	0.05	1.0	2.75	-	-	-	-	-		
		2515	●	●	●	●	25	-	-	0.05	1.5	3.75	-	-	-	-	-		
		2520	●	●	●	●	25	-	-	0.05	2.0	3.75	-	-	-	-	-		
		2525	●	●	●	●	25	-	-	0.05	2.5	3.75	-	-	-	-	-		
Threading		SBTR/L 2560-N-005	●	●	●	●	25	-	-	0.05	-	-	1.59	-	0.2	2.0			
		2560-N-010	●	●	●	●	25	-	-	0.10	-	-	1.59	-	1.0	2.0			
		2560-R-005	●	●	●	●	25	-	-	0.05	-	-	0.6	-	0.2	1.5			
		2560-R-010	●	●	●	●	25	-	-	0.10	-	-	0.6	-	1.0	1.5			
		2560-L-005	●	●	●	●	25	-	-	0.05	-	-	0.6	-	0.2	1.5			
		2560-L-010	●	●	●	●	25	-	-	0.10	-	-	0.6	-	1.0	1.5			

● : Stock item



B Auto Tools (Blade type)

Insert

Application	Picture	Designation	Coated				Dimensions (mm)										Configuration	Feed direction
			PC8110		PC5300		l	α	t	r	La	ar	f	D-MAX	Pitch range			
			R	L	R	L									Min.	Max.		
Parting off		SBCR/L 250708-N	●	●	●	●	25	0	-	0.05	0.7	4.3	-	8	-	-		
		251012-N	●	●	●	●	25	0	-	0.05	1.0	6.3	-	12	-	-		
		251512-N	●	●	●	●	25	0	-	0.05	1.5	6.3	-	12	-	-		
		252016-N	●	●	●	●	25	0	-	0.05	2.0	8.3	-	16	-	-		
		250708-R	●	●	●	●	25	15	-	0.05	0.7	4.3	-	8	-	-		
		251012-R	●	●	●	●	25	15	-	0.05	1.0	6.3	-	12	-	-		
		251512-R	●	●	●	●	25	15	-	0.05	1.5	6.3	-	12	-	-		
		252016-R	●	●	●	●	25	15	-	0.05	2.0	8.3	-	16	-	-		
		250708-L	●	●	●	●	25	15	-	0.05	0.7	4.3	-	8	-	-		
		251012-L	●	●	●	●	25	15	-	0.05	1.0	6.3	-	12	-	-		
		251512-L	●	●	●	●	25	15	-	0.05	1.5	6.3	-	12	-	-		
		252016-L	●	●	●	●	25	15	-	0.05	2.0	8.3	-	16	-	-		
		251012-T	●	●	●	●	25	0	-	0.05	1.0	6.3	-	12	-	-		
		251512-T	●	●	●	●	25	0	-	0.05	1.5	6.3	-	12	-	-		
		252016-T	●	●	●	●	25	0	-	0.05	2.0	8.3	-	16	-	-		

● : Stock item

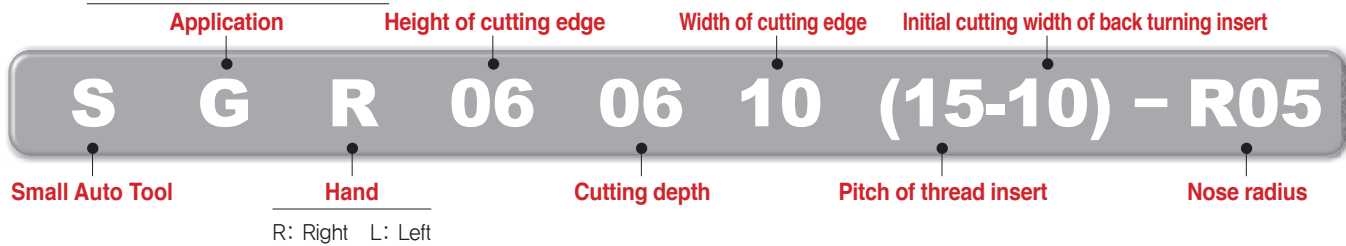


Auto Tools (For multi utility)

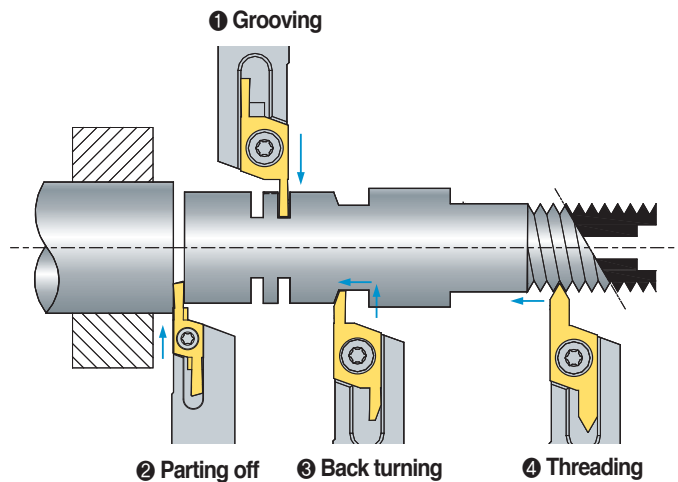
- Multifunctional insert for automatic lathes
- For external machining of precise small parts
- 5 types - SB (for back turning), SG (for grooving), ST (for threading), SC (for parting off), SGB (for grooving and back turning)
- Convenient use of one holder to all inserts
- Offset "0" to all ISO type holders

Code system

B: Back turning G: Grooving
 C: Parting off T: Threading
 GB : Grooving and back turning

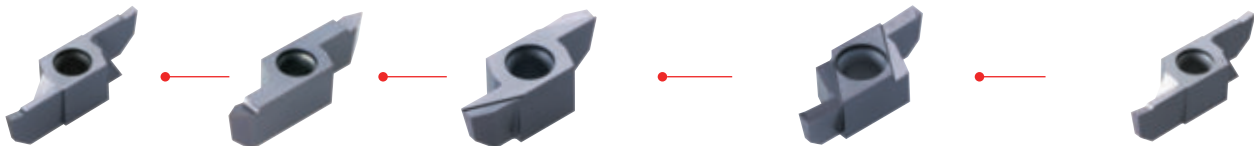


Application example



Types of multifunctional insert

Possible to apply various types of blade inserts to one holder (Ex: All designations of 06 size inserts can be applied to one 06 size holder.)



SG: Grooving

ST: Threading

SB: Back turning

SGB: Grooving and back turning

SC: Parting off

Recommended cutting conditions

Workpiece	Turning		Grooving		Parting off		Back turning	
	Cutting speed, vc (m/min)	Feed, fn (mm/rev)	Cutting speed, vc (m/min)	Feed, fn (mm/rev)	Cutting speed, vc (m/min)	Feed, fn (mm/rev)	Cutting speed, vc (m/min)	Feed, fn (mm/rev)
P Carbon steel	50~150	0.01~0.25	50~150	0.02~0.08	50~150	0.01~0.08	50~150	0.01~0.25
Free cutting steel	30~150	0.02~0.25	30~150	0.02~0.08	30~150	0.01~0.08	30~150	0.01~0.25
M Stainless steel	50~120	0.02~0.20	30~120	0.02~0.05	30~120	0.02~0.05	30~120	0.02~0.20
N Non-ferrous metal	70~200	0.03~0.25	70~200	0.03~0.10	70~200	0.03~0.10	70~200	0.03~0.30



B Auto Tools (For multi utility)

SXGNR/L

SBR, SGBR
SCR, STR, SGR



SXGNR/L1212-X08A follows the configuration above.

R type insert (mm)

Designation	H	W	L	S	h	h1	Insert	Screw	Wrench
SXGNR/L 1010-X06A	10	10	125	10	10	6	S□R/L 06	FTNA 0408	TW 15P
	12	12	125	12	12	6			
	16	16	125	16	16	6			
	20	20	125	20	20	6			
SXGNR/L 1212-X08A	12	12	130	12	12	8	S□R/L 08	FTNA 0411	TW 15P
	16	16	130	16	16	8			
	20	20	130	20	20	8			
	20	20	130	20	20	8			


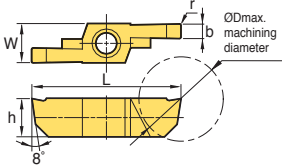
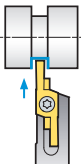
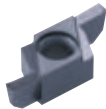
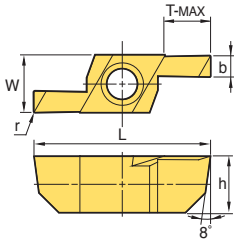
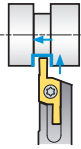

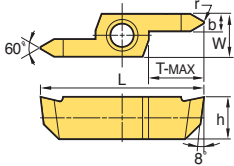
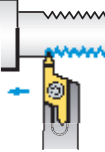
Insert

Application	Picture	Designation	Coated		Dimensions (mm)								Configuration	Feed direction
			PC9030		b1	b	W	L	r	h	T-MAX	ØD		
			R	L										
Back turning		SBR/L 060520-10-R00			1	2	8	22	0	6	5.5	-		
		SBR/L 060520-10-R05			1	2	8	22	0.05	6	5.5	-		
		SBR/L 060520-10-R10			1	2	8	22	0.1	6	5.5	-		
		SBR/L 060630-20-R00			2	3	8	24	0	6	6.5	-		
		SBR/L 060630-20-R05			2	3	8	24	0.05	6	6.5	-		
		SBR/L 060630-20-R10			2	3	8	24	0.1	6	6.5	-		
		SBR/L 080630-20-R00			2	3	8	23	0	8	6.5	-		
		SBR/L 080630-20-R05			2	3	8	23	0.05	8	6.5	-		
		SBR/L 080630-20-R10			2	3	8	23	0.1	8	6.5	-		
		SBR/L 080840-20-R00			2	4	8	27	0	8	8.5	-		
SBR/L 080840-20-R05			2	4	8	27	0.05	8	8.5	-				
SBR/L 080840-20-R10			2	4	8	27	0.1	8	8.5	-				
Parting off		SCR/L 060610-R00			-	1	8	24	0	6	-	11		
		SCR/L 060610-R05	●		-	1	8	24	0.05	6	-	11		
		SCR/L 060610-R10	●		-	1	8	24	0.1	6	-	11		
		SCR/L 060615-R00			-	1.5	8	24	0	6	-	11		
		SCR/L 060615-R05	●		-	1.5	8	24	0.05	6	-	11		
		SCR/L 060615-R10	●		-	1.5	8	24	0.1	6	-	11		
		SCR/L 060620-R00			-	2	8	24	0	6	-	11		
		SCR/L 060620-R05	●		-	2	8	24	0.05	6	-	11		
		SCR/L 060620-R10	●		-	2	8	24	0.1	6	-	11		
		SCR/L 081015-R00			-	1.5	8	31	0	8	-	18		
		SCR/L 081015-R05			-	1.5	8	31	0.05	8	-	18		
		SCR/L 081015-R10			-	1.5	8	31	0.1	8	-	18		
		SCR/L 081020-R00			-	2	8	31	0	8	-	18		
		SCR/L 081020-R05			-	2	8	31	0.05	8	-	18		
		SCR/L 081020-R10	●		-	2	8	31	0.1	8	-	18		
		SCR/L 081025-R00			-	2.5	8	31	0	8	-	18		
		SCR/L 081025-R05	●		-	2.5	8	31	0.05	8	-	18		
		SCR/L 081025-R10	●		-	2.5	8	31	0.1	8	-	18		
SCR/L 081030-R00			-	3	8	31	0	8	-	18				
SCR/L 081030-R05	●		-	3	8	31	0.05	8	-	18				
SCR/L 081030-R10			-	3	8	31	0.1	8	-	18				

● : Stock item



Insert

Application	Picture	Designation	Coated		Dimensions (mm)								Configuration	Feed direction
			PC9030		b	W	L	r	h	T-MAX	ØD	Pitch		
			R	L										
Grooving		SGR/L 060610-R00			1	8	24	0	6	-	11	-		
		060610-R05	●		1	8	24	0.05	6	-	11	-		
		060610-R10	●		1	8	24	0.1	6	-	11	-		
		060615-R00			1.5	8	24	0	6	-	11	-		
		060615-R05	●		1.5	8	24	0.05	6	-	11	-		
		060615-R10	●		1.5	8	24	0.1	6	-	11	-		
		060620-R00			2	8	24	0	6	-	11	-		
		060620-R05	●		2	8	24	0.05	6	-	11	-		
		060620-R10	●		2	8	24	0.1	6	-	11	-		
		081015-R00			1.5	8	31	0	8	-	18	-		
		081015-R05			1.5	8	31	0.05	8	-	18	-		
		081015-R10			1.5	8	31	0.1	8	-	18	-		
		081020-R00			2	8	31	0	8	-	18	-		
		081020-R05	●		2	8	31	0.05	8	-	18	-		
		081020-R10			2	8	31	0.1	8	-	18	-		
		081025-R00			2.5	8	31	0	8	-	18	-		
		081025-R05			2.5	8	31	0.05	8	-	18	-		
		081025-R10			2.5	8	31	0.1	8	-	18	-		
081030-R00			3	8	31	0	8	-	18	-				
081030-R05			3	8	31	0.05	8	-	18	-				
081030-R10			3	8	31	0.1	8	-	18	-				
Grooving and back turning		SGBR/L 0604520-R00			2	8	22	0	6	4.5	-	-		
		0604520-R05			2	8	22	0.05	6	4.5	-	-		
		0604520-R10			2	8	22	0.1	6	4.5	-	-		
		0604525-R00			2.5	8	22	0	6	4.5	-	-		
		0604525-R05			2.5	8	22	0.05	6	4.5	-	-		
		0604525-R10			2.5	8	22	0.1	6	4.5	-	-		
		0605530-R00			3	8	24	0	6	5.5	-	-		
		0605530-R05			3	8	24	0.05	6	5.5	-	-		
		0605530-R10			3	8	24	0.1	6	5.5	-	-		
		0805525-R00			2.5	8	24	0	8	5.5	-	-		
		0805525-R05			2.5	8	24	0.05	8	5.5	-	-		
		0805525-R10			2.5	8	24	0.1	8	5.5	-	-		
		0806530-R00			3	8	26	0	8	6.5	-	-		
		0806530-R05			3	8	26	0.05	8	6.5	-	-		
0806530-R10			3	8	26	0.1	8	6.5	-	-				
Threading		STR/L 06073215			3.2	8	25	0.06	6	7	-	0.5-1.5		
		06073230			3.2	8	25	0.19	6	7	-	1.5-3.0		
		08103215			3.2	8	31	0.06	8	10.5	-	0.5-1.5		
		08103230			3.2	8	31	0.19	8	10.5	-	1.5-3.0		

● : Stock item



AutoTools (KGT/MGT type)

- Grooving insert for automatic lathes
- Exclusive holder for automatic lathes
- Economic double sided insert
- Strong clamping system secures stable machining and precision.
- A wide selection of chip breakers according to various cutting conditions such as low/high feed, continuous/interrupted machining, etc.

Code system

• Insert

KG	M	N	300	-	04	-	T
System code	Tolerance	Hand	Width of cutting edge		Corner nose radius of insert		Chip breaker
KG SYSTEM (KORLOY Grooving) MG SYSTEM (Multi Grooving)	M: Pressed class G: Ground class	N: Neutral R: Right L: Left I: Internal	2,0~8,0 mm		0,2 mm 0,3 mm 0,4 mm		L/R/T/C LP/RP

• Holder

KG	E	H	R/L	1212	-	3	D25A
System code	Application	Holder type	Hand	Shank size	Cutting width		Max. cutting diameter
KG SYSTEM (KORLOY Grooving) MG SYSTEM (Multi Grooving)	E: External machining I: Internal machining	H: Horizontal type V: Vertical type U: Undercut type	R: Right L: Left	Height 12 mm, width 12 mm (For internal machining: Min. machining diameter)	2,0~3,0 mm		Ø15~Ø32 mm

Chip breaker line-up

KGT Type

KGMM-L	KGMM-R
<ul style="list-style-type: none"> • Sharp cutting edge • For low feed machining • For small diameter parts 	<ul style="list-style-type: none"> • Reinforced cutting edge • For high feed machining • For interrupted cutting
KGMM-T	KGMR/L-LP
<ul style="list-style-type: none"> • Sharp cutting edge • Stronger chip control • For turning and grooving 	<ul style="list-style-type: none"> • Sharp cutting edge • For low feed machining • Small diameter component • Right/Left handed
KGMR/L-RP	KGMM-C
<ul style="list-style-type: none"> • Strong cutting edge • For high feed machining • For interrupted cutting • Right/Left handed 	<ul style="list-style-type: none"> • Improved chip control • Relief • Carbon steel • Copying • Cast iron • Alloy steel • Stainless

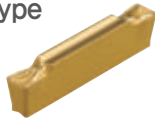
MGT Type

MGM(G)N-M	MGMN-G
<ul style="list-style-type: none"> • Easier chip control by narrowing chip width with the use of chip breaker on rake surface center • Smooth chip flow by small dots in external machining • Available for both external machining and grooving 	<ul style="list-style-type: none"> • Specially designed chip breaker allows narrower chips to promote better chip flow with the use of center dots • Exclusive chip breaker for grooving

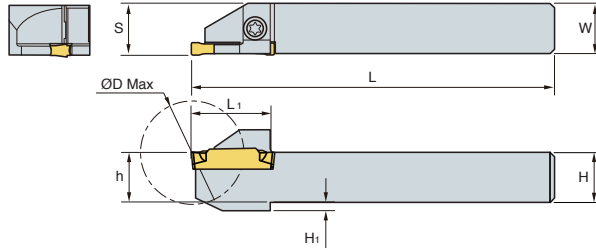


KGEHR/L-D00A

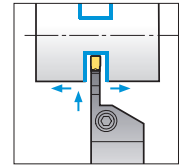
Compact type



KGGN KGMN KGMR/L
KRGN KRMN



Grooving, turning, parting off



• R type insert (mm)

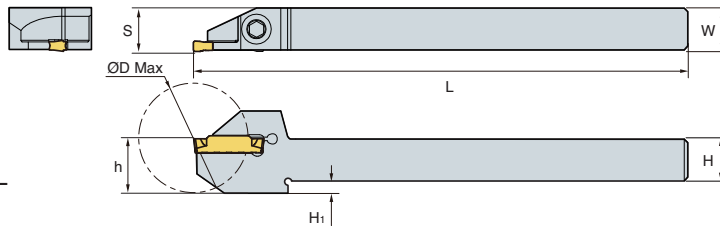
Designation	Dimensions (mm)							Insert	Screw	Wrench	
	H	W	L ₁	L	S	h ₁	ØD_MAX				
KGEHR/L	1010-2-D20A	10	10	19	125	10.2	2	20	KGMN200-□-□ KGMR/L200-□-□ KRMN200-C	ETNA0412	TW15L
	1212-2-D25A	12	12	19	125	12.2	2	25			
	1414-2-D25A	14	14	19	125	14.2	-	25			
	1616-2-D32A	16	16	24	125	16.2	-	32			
1212-3-D25A	12	12	19	130	12.4	2	25	KGMN300-□-□ KGMR/L300-□-□ KRMN300-C			
1616-3-D32A	16	16	24	130	16.4	-	32				

KGEHR/L-D00B

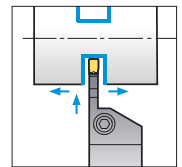
High rigidity type



KGGN KGMN KGMR/L
KRGN KRMN



Grooving, turning, parting off



• R type insert (mm)


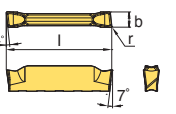

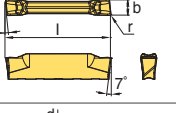

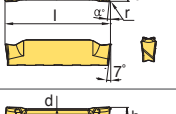

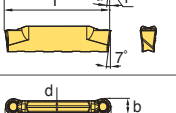

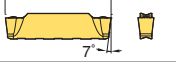
Designation	Dimensions (mm)							Insert	Screw	Wrench
	H	W	L	S	h ₁	ØD_MAX				
KGEHR/L	1010-2-D30B	10	10	125	10.2	6.6	30	KGMN200-□-□ KGMR/L200-□-□ KRMN200-C	MHA0512	HW40L
	1212-2-D25B	12	12	125	12.5	3.5	25			
	1212-2-D30B	12	12	125	12.2	3.5	30			
	1616-2-D32B	16	16	125	16.2	-	32			
	1212-3-D25B	12	12	125	12.4	3.5	25			
	1212-3-D32B	12	12	125	12.4	3.5	32			
1616-3-D32B	16	16	125	16.4	-	32	KGMN300-□-□ KGMR/L300-□-□ KRMN300-C			

KGT Insert

Application	Picture	Designation	Coated						Dimensions (mm)					Configuration	
			NC3120	NC3225	NC5330	NC6315	PC3035	PC5300	PC9030	b	r	l	d		α°
Grooving		KGMN 200-02-L 300-02-L	●	●			●	●	●	2.0	0.2	20	1.7	-	
			●	●			●	●	●	3.0	0.2	20	2.3	-	
Grooving - Parting off		KGMN 200-02-R 300-02-R	●	●			●	●	●	2.0	0.2	20	1.7	-	
			●	●			●	●	●	3.0	0.2	20	2.3	-	
Grooving - turning		KGMN 200-02-T 300-02-T 300-04-T	●	●	●	●	●	●	2.0	0.2	20	1.7	-		
			●	●	●	●	●	●	3.0	0.2	20	2.3	-		
			●	●	●	●	●	●	3.0	0.4	20	2.3	-		

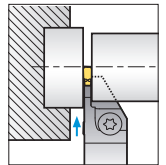
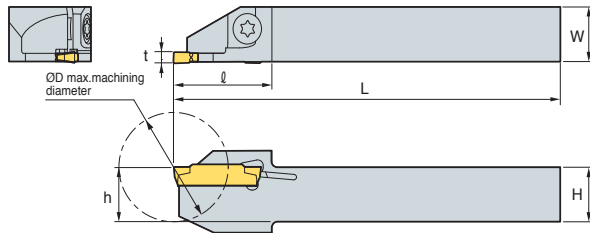
B Auto Tools (KGT/MGT type)

KGT Insert



Application	Picture	Designation	Coated						Dimensions (mm)					Configuration	
			NC3120	NC3225	NC5330	NC6315	PC3035	PC5300	PC9030	b	r	l	d		α°
Parting off (Right handed)		KGMR	200-6D-LP			●		●	2.0	0.2	20	-	6		
			200-15D-LP			●		●	2.0	0.2	20	-	15		
			300-6D-LP			●		●	3.0	0.2	20	-	6		
			300-15D-LP			●		●	3.0	0.2	20	-	15		
Parting off (Right handed)		KGMR	200-6D-RP			●		●	2.0	0.2	20	-	6		
			200-15D-RP			●		●	2.0	0.2	20	-	15		
			300-6D-RP			●		●	3.0	0.2	20	-	6		
			300-15D-RP			●		●	3.0	0.2	20	-	15		
Parting off (Left handed)		KGML	200-6D-LP						2.0	0.2	20	1.7	6		
			200-15D-LP						2.0	0.2	20	1.7	15		
			300-6D-LP						3.0	0.2	20	2.3	6		
			300-15D-LP						3.0	0.2	20	2.3	15		
Parting off (Left handed)		KGML	200-6D-RP						2.0	0.2	20	1.7	6		
			200-15D-RP						2.0	0.2	20	1.7	15		
			300-6D-RP						3.0	0.2	20	2.3	6		
			300-15D-RP						3.0	0.2	20	2.3	15		
Copying		KRMN	200-C		●	●	●	●	●	2.0	1.0	20	1.7	-	
			300-C		●	●	●	●	●	3.0	1.5	20	2.2	-	

● : Stock item


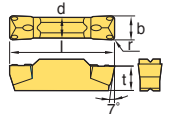

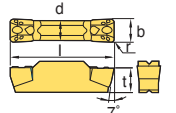
MGEHR/L



• R type insert (mm)

Designation	ØD	H = h	W	L	l	t	Insert	Screw	Wrench	
										
MGEHR/L	1010-X15A	20	10	10	125	18	1.5	MGMN150-G	ETNA 0412	TW 15L
	1212-X15A	25	12	12	125	19.5	1.5			
	1010-X20A	20	10	10	125	18	2			
	1212-X20A	25	12	12	125	19.5	2	MGMN200-M MGMN200-G	ETNA 0412	TW 15L
	1616-X20A	32	16	16	125	25	2			
	1010-X25A	20	10	10	125	20	2.5	MGMN250-M MGMN250-G	ETNA 0412	TW 15L
1212-X25A	25	12	12	125	20	2.5				
1616-X25A	32	16	16	125	25	2.5				

MGT Insert

Application	Picture	Designation	Coated						Uncoated			Dimensions (mm)					Configuration
			NC3120	NC3225	NC3030	NC5330	NC6315	PC5300	PC9030	H01	G10	ST30A	b	r	l	d	
Grooving		MGMN	150-G		●	●						1.5	0.15	16.0	1.2	3.5	
			200-G		●	●						2.0	0.2	16.0	1.6	3.5	
			250-G		●	●						2.5	0.2	18.5	2.0	3.85	
Grooving		MGMN	200-M	●	●	●	●		●			2.0	0.2	16.0	1.6	3.5	
			250-M	●	●	●			●			2.5	0.2	18.5	2.0	3.85	

● : Stock item



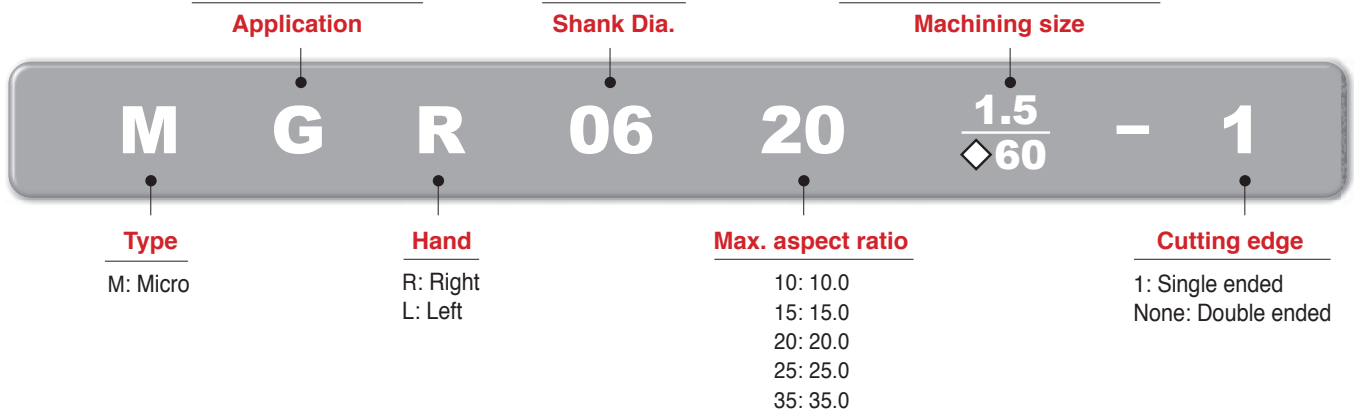
Auto Tools (MSB tool)

- High hardness grade guarantees longer tool life
- Various kinds of machining (Fitting, Valve, Medical parts, Automobile component, and Semiconductor equipment) are available
- Various types of MSB tools (Boring, Grooving, Threading)

Code system

B	: Boring	
BC	: Copying	
BB	: Back Boring	
BF	: Chamfering	03: 3.0
G	: Square Grooving	04: 4.0
GR	: Round Grooving	06: 6.0
GF	: Face Grooving	08: 8.0
T	: Threading	10: 10.0

Boring	No Code		
Copying	Width of Groove		
Threading	60°	55°	
	Pitch	tpi	
◇	F	0.25~1.0	72~24
	A	0.5~1.5	48~16
	AG	0.5~3.0	48~8



MSB tool code system

Types		Application	Designation	
01	Boring	Boring	MBR/LOO☆☆	
02		Copying	MBCR/LOO☆☆	
03		Back Boring	MBBR/LOO☆☆	
04		Chamfering	MBFR/LOO☆☆	
05	Grooving	Square Grooving	MGR/LOO☆☆-□□	
06		Round Grooving	MGRR/LOO☆☆-□□	
07		Face Grooving	MGFR/LOO00-□□	
08	Threading	Partial	60° 55°	MTR/LOO☆☆-◇60 MTR/LOO☆☆-◇55

Details

Marks	○○	Shank Dia.			
	☆☆	Max. depth of boring			
	□□	Width of groove			
	◇	Pitch/tpi	F	0.25~1.0	72~24
			A	0.5~1.5	48~16
AG			0.5~3.0	48~8	

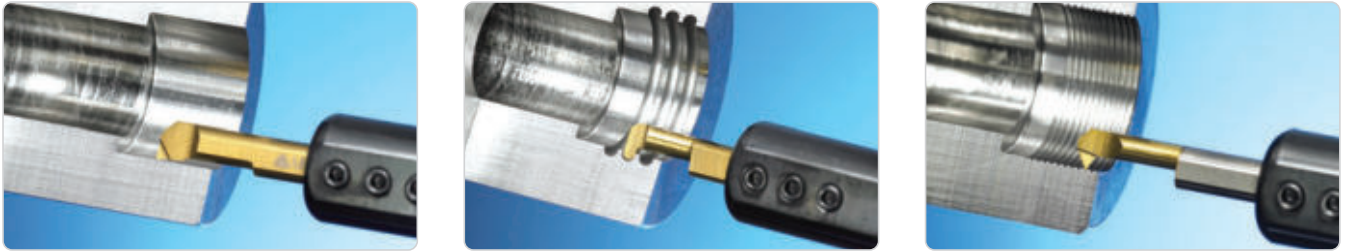


B Auto Tools (MSB tool)

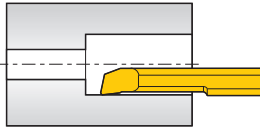
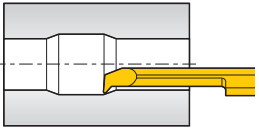
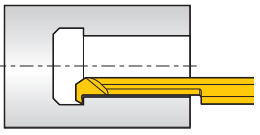
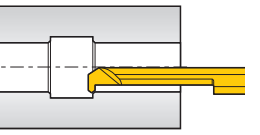
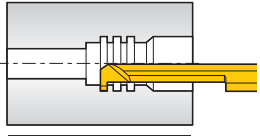
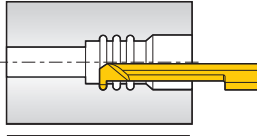
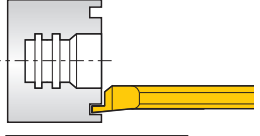
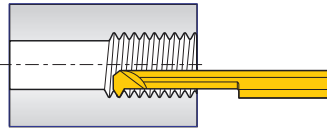
Grades

Grades	Coating	Application and features
Z12M	Carbide	Ultra fine grain substrate ensures superior wear resistance and toughness Application: Cast iron, Aluminum alloy and Non-ferrous metals machining
PC30M	TiN coating	TiN coated ultra fine grain substrate ensures long tool life Application: Stainless steel, heat resisting alloy and hard-to-cut material machining

Machining types

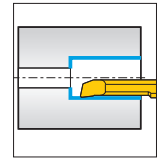
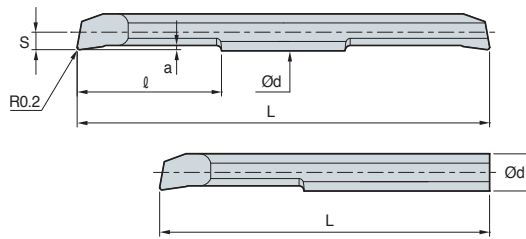


Types

Boring	 <p>Boring Min. dia. of machining: Ø3.2</p>	 <p>Copying Min. dia. of machining: Ø4.2</p>	 <p>Back Boring Min. dia. of machining: Ø3.2</p>	 <p>Chamfering Min. dia. of machining: Ø4.2</p>
Grooving	 <p>Square Grooving Min. dia. of machining: Ø3.2</p>	 <p>Round Grooving Min. dia. of machining: Ø3.2</p>	 <p>Face Grooving Min. dia. of machining: Ø6.0</p>	
Threading	 <p>Threading Min. dia. of machining: Ø3.3</p>			



Boring

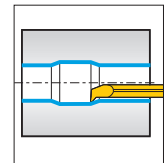
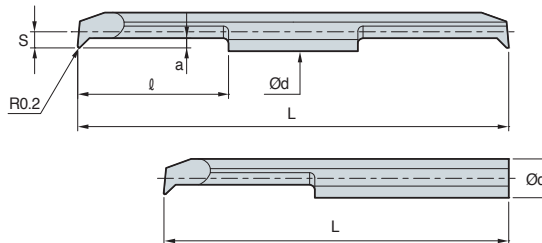


(mm)

Twin Edge			Single Edge			Ød	Min.dia. of machining	l	Overall length		Detailed cutting edge		
Designation	Coated	Uncoated	Designation	Coated	Uncoated				L		a	S	
	PC30M	Z12M		PC30M	Z12M				Double ended	Single ended			
MBR	0310	●	MBR	0310-1		3.0	3.2	10	40	35	0.5	1.4	
	0315	●		0315-1					15	50			45
	0410	●		0410-1		4.0	4.2	10	40	35	0.6	1.9	
	0415	●		0415-1					15	50			45
	0420	●		0420-1					20	60			50
	0610	●		0610-1		6.0	6.2	10	45	40	0.75	2.9	
	0615	●		0615-1					15	55			45
	0620	●		0620-1					20	65			50
	0810	●		0810-1		8.0	8.2	10	50	45	0.8	3.9	
	0820	●		0820-1					20	70			60
	0830			0830-1					30	80			70
	1015	●		1015-1		10.0	10.2	15	60	60	1.0	4.9	
	1025	●		1025-1					25	80			70
	1035	●		1035-1					35	100			80

● : Stock item

Copying



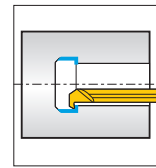
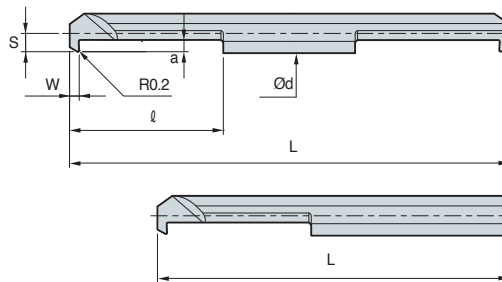
(mm)

Twin Edge			Single Edge			Ød	Min.dia. of machining	l	Overall length		Detailed cutting edge		
Designation	Coated	Uncoated	Designation	Coated	Uncoated				L		a	S	
	PC30M	Z12M		PC30M	Z12M				Double ended	Single ended			
MBCR	0410	●	MBCR	0410-1		4.0	4.2	10	40	35	1.0	1.9	
	0415	●		0415-1					15	50			45
	0420	●		0420-1					20	60			50
	0610	●		0610-1		6.0	6.2	10	45	40	1.3	2.9	
	0615	●		0615-1					15	55			45
	0620	●		0620-1					20	60			50

● : Stock item



Back Boring

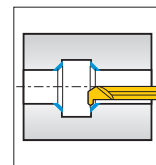
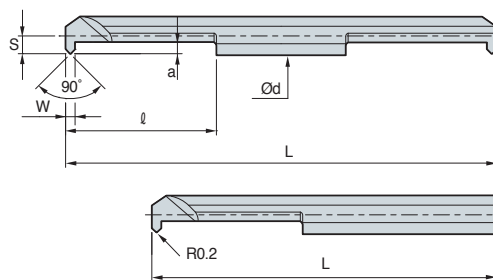


(mm)

Twin Edge			Single Edge			Ød	Min.dia. of machining	ℓ	Overall length		Detailed cutting edge			
Designation	Coated	Uncoated	Designation	Coated	Uncoated				L		W	a	S	
	PC30M	Z12M		PC30M	Z12M				Double ended	Single ended				
MBBR	0310	●	MBBR	0310-1		3.0	3.2	10	40	35	1.5	0.8	1.4	
	0315	●		0315-1					15	50				45
	0410	●		0410-1		4.0	4.2	10	40	35	2.0	1.3	1.9	
	0415	●		0415-1					15	50				45
	0420	●		0420-1					20	60				50
	0610	●		0610-1		6.0	6.2	10	45	40	2.0	1.9	2.9	
	0615	●		0615-1					15	55				45
	0620	●		0620-1					20	65				50

● : Stock item

Chamfering



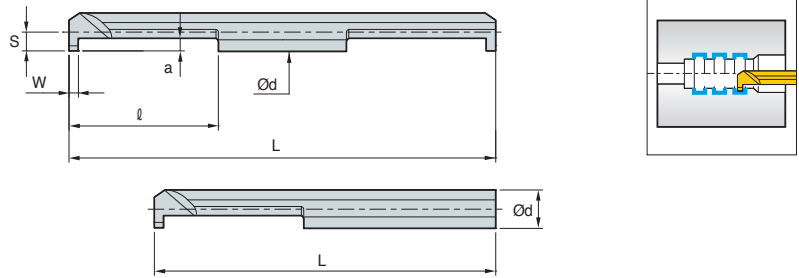
(mm)

Twin Edge			Single Edge			Ød	Min.dia. of machining	ℓ	Overall length		Detailed cutting edge			
Designation	Coated	Uncoated	Designation	Coated	Uncoated				L		W	a	S	
	PC30M	Z12M		PC30M	Z12M				Double ended	Single ended				
MBFR	0410	●	MBFR	0410-1		4.0	4.2	10	40	35	0.8	1.0	1.9	
	0415	●		0415-1					15	50				45
	0420	●		0420-1					20	60				50
	0610	●		0610-1		6.0	6.2	10	45	40	1.4	1.2	2.9	
	0615	●		0615-1					15	55				45
	0620	●		0620-1					20	65				50

● : Stock item



Square Grooving



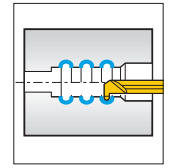
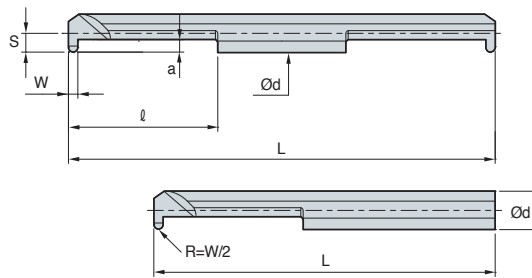
(mm)

MGR	Twin Edge		Single Edge			Ød	Min.dia. of machining	l	Overall length		Detailed cutting edge			
	Designation	Coated	Uncoated	Designation	Coated				Uncoated	L		W	a	S
		PC30M	Z12M		PC30M				Z12M	Double ended	Single ended			
	0310-1.0	●		MGR 0310-1.0-1			3.0	3.2	10	40	35	1.0	0.8	1.4
	0315-1.0	●		0315-1.0-1		15			50	45				
	0310-1.5	●		0310-1.5-1		10			40	35				
	0315-1.5	●		0315-1.5-1		15			50	45				
	0410-1.0	●		0410-1.0-1		4.0	4.2	10	40	35	1.0	1.4	1.9	
	0420-1.0			0420-1.0-1				20	60	50				
	0410-1.5			0410-1.5-1				10	40	35				
	0420-1.5			0420-1.5-1				20	60	50				
	0410-2.0	●		0410-2.0-1				10	40	35				
	0420-2.0			0420-2.0-1				20	60	50				
	0610-1.0	●		0610-1.0-1		6.0	6.2	10	45	40	1.0	1.8	2.9	
	0620-1.0	●		0620-1.0-1				20	65	50				
	0610-1.5	●		0610-1.5-1				10	45	40				
	0620-1.5	●		0620-1.5-1				20	65	50				
	0610-2.0	●		0610-2.0-1				10	45	40				
	0620-2.0	●		0620-2.0-1				20	65	50				
	0610-2.5	●		0610-2.5-1				10	45	40				
	0620-2.5	●		0620-2.5-1				20	65	50				
	0820-1.5	●		0820-1.5-1		8.0	8.2	20	70	60	1.5	2.5	3.9	
	0820-2.0	●		0820-2.0-1							2.0			
	0820-2.5	●		0820-2.5-1							2.5			
	0820-3.0	●		0820-3.0-1							3.0			
	1025-1.5	●		1025-1.5-1		10.0	10.2	25	80	70	1.5	2.5	4.9	
	1025-2.0	●		1025-2.0-1							2.0			
	1025-2.5	●		1025-2.5-1							2.5			
	1025-3.0	●		1025-3.0-1							3.0			

● : Stock item



Round Grooving

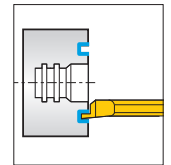
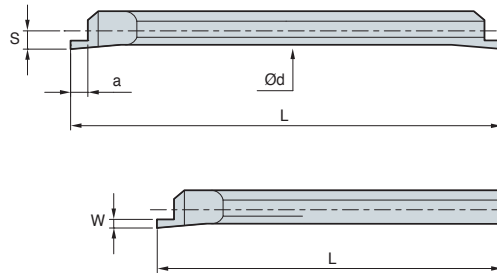
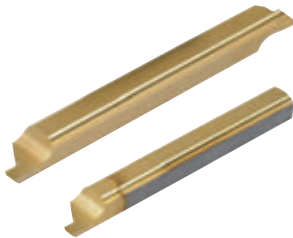


(mm)

Twin Edge			Single Edge			Ød	Min.dia. of machining	l	Overall length		Detailed cutting edge			
Designation	Coated	Uncoated	Designation	Coated	Uncoated				L		W	a	S	
	PC30M	Z12M		PC30M	Z12M				Double ended	Single ended				
MGRR	0310-0.8	●	MGRR	0310-0.8-1		3.0	3.2	10	40	35	0.8	0.8	1.4	
	0315-0.8	●		0315-0.8-1					15	50				45
	0410-1.0	●		0410-1.0-1		4.0	4.2	10	40	35	1.0	1.0	1.9	
	0420-1.0	●		0420-1.0-1					20	60				50
	0610-1.0	●		0610-1.0-1		6.0	6.2	10	45	40	1.0	2.0	2.9	
	0620-1.0	●		0620-1.0-1					20	65				50
	0610-1.5	●		0610-1.5-1					10	45				40
	0620-1.5	●		0620-1.5-1					20	65	50			
	0610-2.0	●		0610-2.0-1					10	45	40			
	0620-2.0	●		0620-2.0-1		20	65	50	2.0					
	0820-1.0	●		0820-1.0-1		8.0	8.2	20	70	60	1.0	2.3	3.9	
	0820-1.5	●		0820-1.5-1							1.5			
	0820-2.0	●		0820-2.0-1							2.0			
	1025-1.0	●		1025-1.0-1		10.0	10.2	25	80	70	1.0	2.8	4.9	
	1025-1.5	●		1025-1.5-1							1.5			
1025-2.0	●	1025-2.0-1		2.0										

● : Stock item

Face Grooving



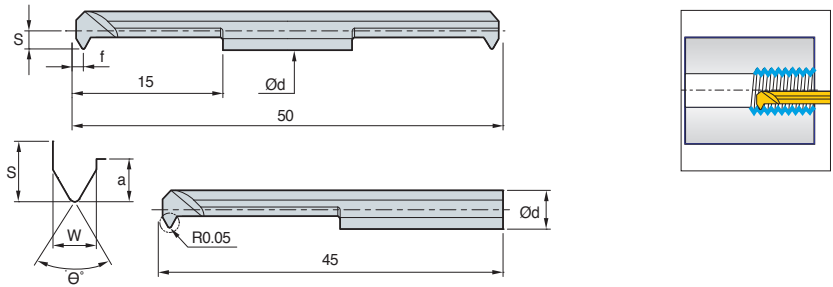
(mm)

Twin Edge			Single Edge			Ød	Min.dia. of machining	Overall length		Detailed cutting edge		
Designation	Coated	Uncoated	Designation	Coated	Uncoated			L		W	a	S
	PC30M	Z12M		PC30M	Z12M			Double ended	Single ended			
MGFR	0400-1.0	●	MGFR	0400-1.0-1		4.0	6.0	50	45	1.0	1.5	1.8
	0400-1.5	●		0400-1.5-1						1.5	2.0	
	0600-1.0	●		0600-1.0-1		6.0	8.5	50	45	1.0	1.5	2.9
	0600-1.5	●		0600-1.5-1						1.5	2.0	
	0600-2.0	●		0600-2.0-1		2.0	2.5					
	0800-1.0	●		0800-1.0-1		8.0	10.4	70	60	1.0	1.5	3.9
	0800-1.5	●		0800-1.5-1						1.5	2.0	
	0800-2.0	●		0800-2.0-1						2.0	2.5	
	0800-2.5	●		0800-2.5-1						2.5	3.0	
	0800-3.0	●		0800-3.0-1						3.0	3.5	
				0800-3.5-1		3.5	4.0					
	1000-2.0	●		1000-2.0-1		10.0	12.4	80	70	2.0	2.5	4.9
	1000-2.5	●		1000-2.5-1						2.5	3.0	
	1000-3.0	●		1000-3.0-1						3.0	3.5	
	1000-3.5	●		1000-3.5-1						3.5	4.0	
1000-4.0	●	1000-4.0-1		4.0	4.5							
1000-4.5	●	1000-4.5-1		4.5	5.0							

● : Stock item



Threading



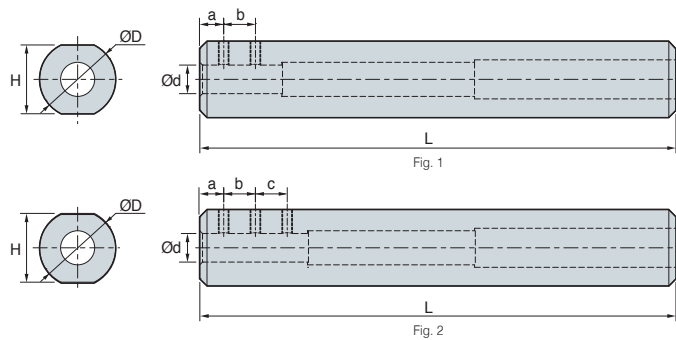
(mm)

Twin Edge			Single Edge			Ød	Min. dia. of machining	Threading			Detailed cutting edge		
Designation	Coated PC30M	Uncoated Z12M	Designation	Coated PC30M	Uncoated Z12M			W	Pitch / tpi	θ°	S	a	f
MTR	0315-F60		MTR	0315-F60-1		3.0	3.3	1.2	0.5~1.0	60°	1.45	1.2	0.6
	0415-F60	●		0415-F60-1		4.0	4.3						
	0615-A60	●		0615-A60-1		6.0	6.2				2.0		
	0315-F55	●		0315-F55-1		3.0	3.3	1.2	48~24	55°	1.45	1.2	0.6
	0415-F55	●		0415-F55-1		4.0	4.3						
	0615-A55	●		0615-A55-1		6.0	6.2				2.0		

● : Stock item

SLEEVE

SL (SLEEVE)



(mm)

Designation	Ød	a	b	c	ØD	H	L	Screw	Wrench	Fig.
SL1603	3	5	-	-	16	14	100	M3	HW15L	1
SL1604	4	5	6	-	16	14	100	M4	HW20L	
SL1605	5	5	8	-	16	14	100	M4	HW20L	
SL1606	6	5	6	6	16	14	100	M4	HW20L	2
SL1607	7	5	6	8	16	14	100	M4	HW20L	
SL2008	8	5	10	10	20	18	100	M4	HW20L	2
SL2010	10	5	10	10	20	18	100	M5	HW20L	

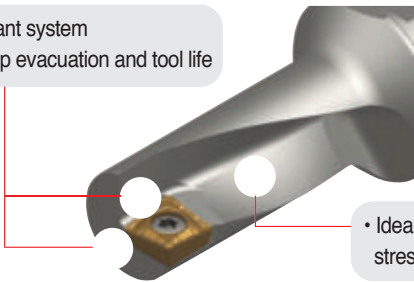
* Fine tolerance and surface roughness

B Technical Information for Multi Turn

• Insert

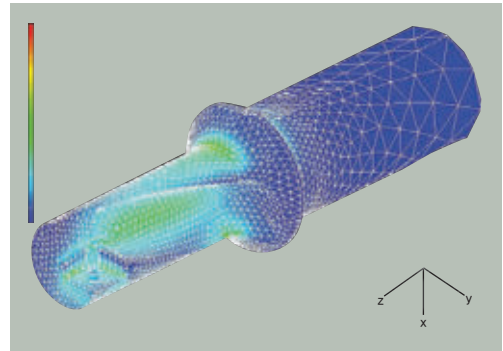


- Double coolant system
- Excellent chip evacuation and tool life



- Ideal flute design minimizing stress concentrations

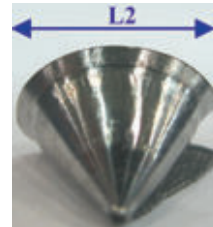
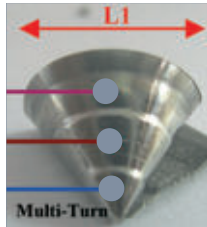
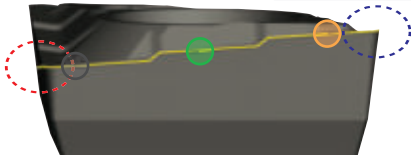
※ Notice: Clamp an insert shown as in the picture



- Minimized stress during cutting, prevented damage from vibration and longer tool life
- Optimized design

Drilling edge
(Drilling)

Turning edge
(Internal, external and face turning)



- Special chip formed by edge geometry better chip
- Evacuation due to small radius width of chip curl

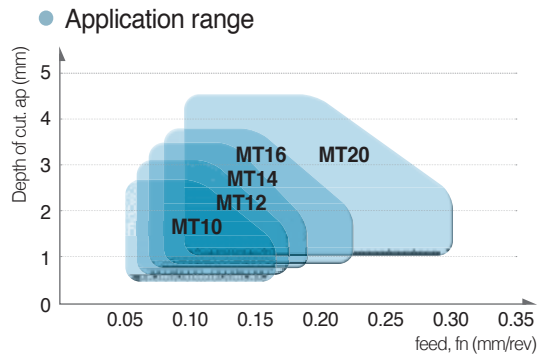
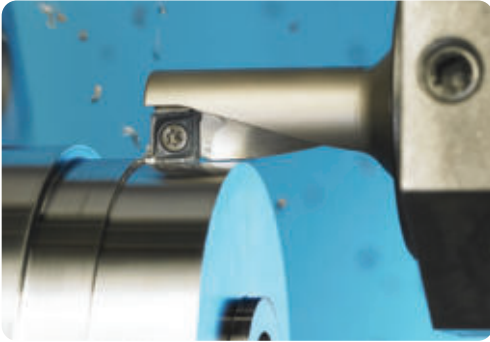
Feed
fn (mm/rev) = 0.08

Feed
fn (mm/rev) = 0.10

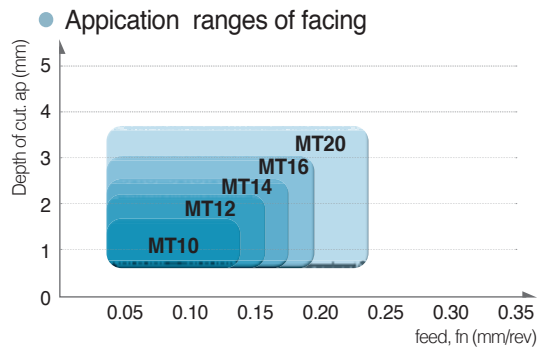
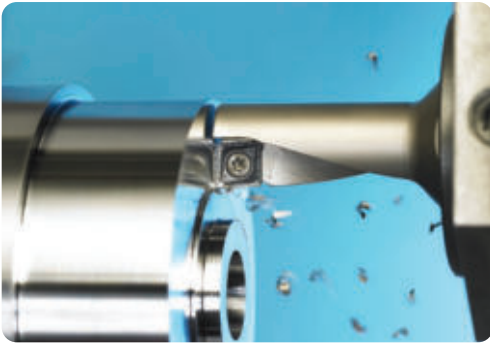


User's guide

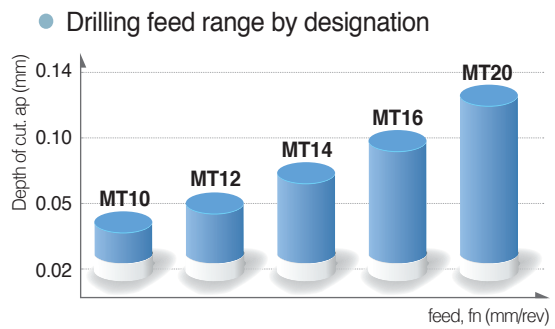
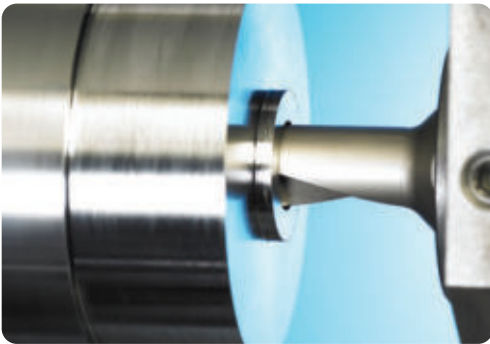
External / Internal turning



Facing

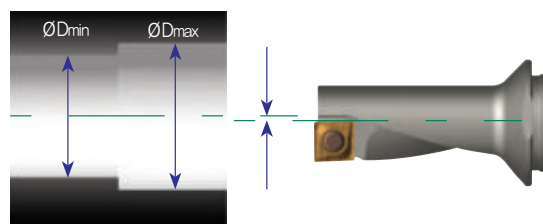


Drilling



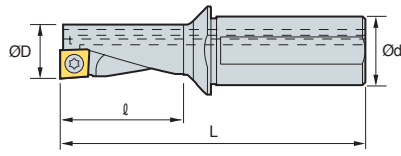
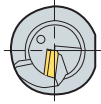
Offset (Diameter compensation)

Disignation	Machined diameter (mm)	ØDmin (mm)	ØDmax (mm)
MT10R/L-2.25D	10	9.85	10.35
MT12R/L-2.25D	12	11.85	12.35
MT14R/L-2.25D	14	13.85	14.35
MT16R/L-2.25D	16	15.85	16.35
MT20R/L-2.25D	20	19.85	20.35
MT25R/L-2.25D	25	24.85	25.35
MT32R/L-2.25D	32	31.85	32.35



Drill diameter is adjustable by the offset compensation

MT (Multi-Turn)



(mm)

Designation		ØD	Ød	l	L	Insert	Screw	Wrench
MT	10R/L-2.25D	10	12	22.5	69.5	QC□T050204	FTNA0204S	TW06P
	12R/L-2.25D	12	16	27.0	78.0	QC□T060204	FTNA02205S	TW06P
	14R/L-2.25D	14	16	31.5	83.5	QC□T070304	FTKA02555	TW07P
	16R/L-2.25D	16	20	36.0	94.0	QC□T080304	FTNA0306	TW09P
	20R/L-2.25D	20	25	45.0	111.0	QC□T10T304	FTNA03508	TW15P
	25R/L-2.25D	25	32	56.5	130.0	QC□T130408	FTNC04509	TW20S
	32R/L-2.25D	32	40	72.0	160.0	QC□T170508	FTNC04511	TW20S

Insert

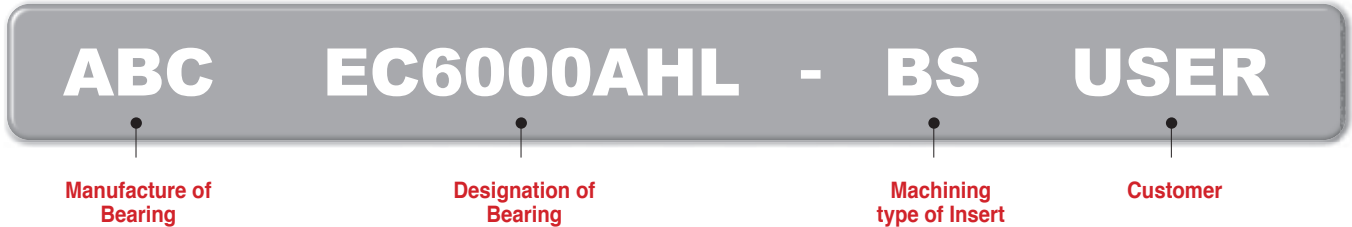
Picture	Designation	Coated				Uncoated		Dimensions (mm)					Configuration
		NC3120	NC3225	NC6315	PC5300	H01	H05	l	d	t	r	Ød ₁	
	QCMT 050204-CM		●	●	●			5.0	5.4	2.10	0.4	2.3	
	060204-CM		●	●	●			6.0	6.4	2.38	0.4	2.5	
	070304-CM		●	●	●			7.0	7.4	3.18	0.4	2.8	
	080304-CM		●	●	●			8.0	8.4	3.18	0.4	3.4	
	10T304-CM		●		●			10.0	10.4	3.97	0.4	4.0	
	130408-CM		●		●			12.7	13.5	4.76	0.8	5.5	
	170508-CM		●	●	●			16.7	17.5	5.56	0.8	5.5	
	QCGT 050204-CA					●		5.0	5.4	2.10	0.4	2.3	
	060204-CA					●		6.0	6.4	2.38	0.4	2.5	
	070304-CA					●		7.0	7.4	3.18	0.4	2.8	
	080304-CA					●		8.0	8.4	3.18	0.4	3.4	
	10T304-CA					●		10.0	10.4	3.97	0.4	4.0	
	130408-CA					●		12.7	13.5	4.76	0.8	5.5	
	170508-CA					●		16.7	17.5	5.56	0.8	5.5	



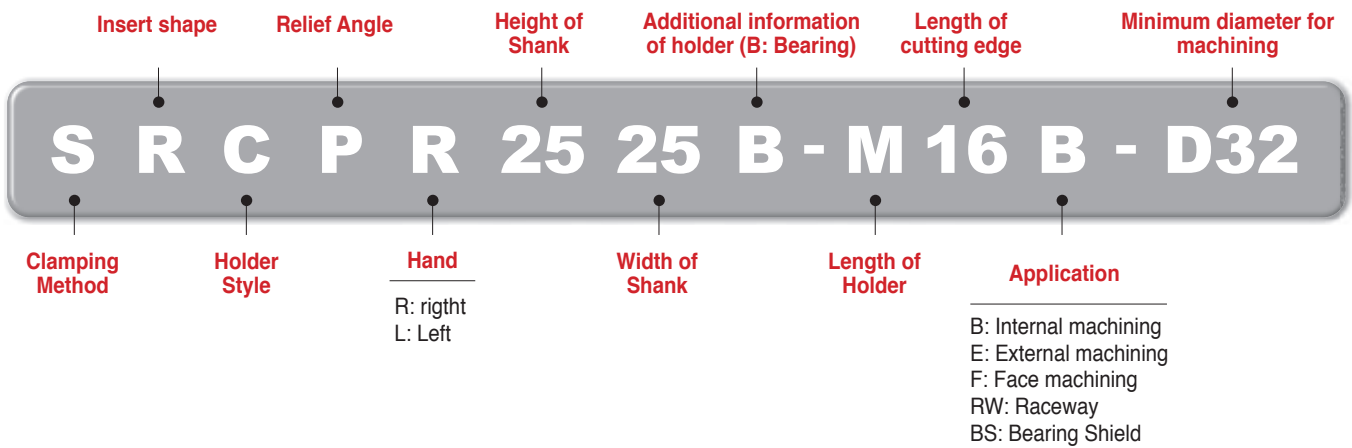
Bearing Solution

Code system

• Insert

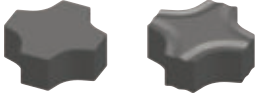


• Holder

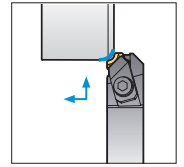
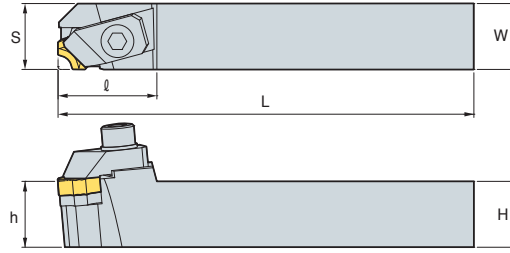
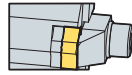


B Bearing Solution

CMSN...F Type



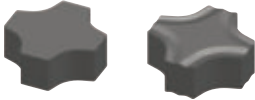
MC12□□ MC12□□-BR
MC15□□



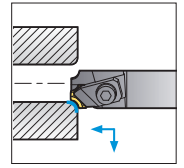
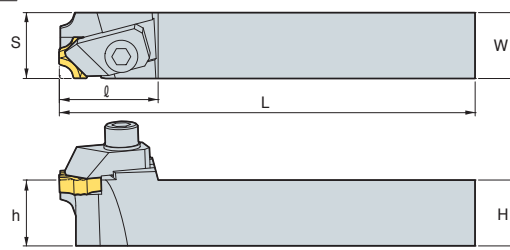
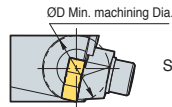
• R type insert (mm)

Designation	H	W	L	S	h	q	Insert	Clamp	Clamp Screw	Shim	Shim Screw	Wrench
CMSNR/L 2020B-L12F	20	20	140	21	20	33	MC12□□	CH6R/L1B	BHA0620	SX42CB	SS0308	HW50L
2023B-L12F	20	23	140	24	20	33	MC12□□-BR					
2525B-L15F	25	25	140	26	25	35	MC15□□	CH6R/L1B	BHA0620	SX52CB	SS0408	HW50L

CMSN...B Type



MC12□□ MC12□□-BR



• R type insert (mm)

Designation	ØD	H	W	L	S	h	q	Insert	Clamp	Clamp Screw	Shim	Shim Screw	Wrench
CMSNR/L 2020B-L12B-D28	28	20	20	140	21	20	33	MC12□□	CH6R/L1B	BHA0620	SX42CB	SS0308	HW50L
2525B-L12B-D28	28	25	25	140	26	25	33		CH6R/L1B	BHA0620	SX42CB	SS0308	HW50L
1620B-L12B-D20	20	16	20	140	18	16	32	MC12□□-BR	CH6R/L1B	BHA0620	-	-	HW50L
2023B-L12B-D28	28	20	23	140	24	20	33		CH6R/L1B	BHA0620	SX42CB	SS0308	HW50L

Insert

Application	Picture	Designation	Cermet	Dimensions (mm)					Configuration
			CN2500	R	θ°	B	d	t	
R-Chamfering		MC0906		0.6	12	1.8	9.525	3.18	
		MC0910		1.0	12	2.4	9.525	3.18	
		MC1206		0.6	18	1.8	12.7	4.76	
		MC1210		1.0	18	2.4	12.7	4.76	
		MC1212		1.2	18	2.2	12.7	4.76	
		MC1215		1.5	18	3.0	12.7	4.76	
		MC1220		2.0	18	3.8	12.7	4.76	
		MC1225		2.5	18	2.8	12.7	4.76	
		MC1525		2.5	18	4.0	15.875	5.56	
		MC1530		3.0	18	4.7	15.875	5.56	
	MC1540		4.0	20	4.7	15.875	5.56		
		MC1206-BR		0.6	18	1.8	12.7	4.76	
		MC1210-BR		1.0	18	2.4	12.7	4.76	
		MC1212-BR		1.2	18	2.2	12.7	4.76	
		MC1215-BR		1.5	18	3.0	12.7	4.76	
		MC1220-BR		2.0	18	3.2	12.7	4.76	
MC1230-BR			3.0	18	3.7	12.7	4.76		
MC1235-BR		3.5	18	3.9	12.7	4.76			

• Stock item

Special order-form

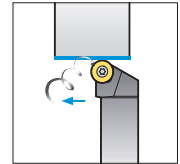
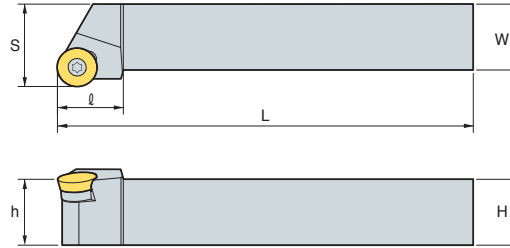
Designation	CN2500	R	θ°	B	d	t	Configuration
MC...							



SRGP...E Type



RPGT1203M0
RPGT1604M0
RPGT2004M0



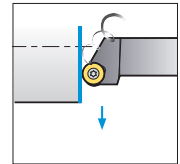
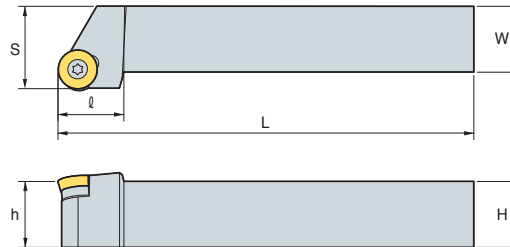
• R type insert
(mm)

Designation	H	W	L	S	h	l	Insert	Screw	Shim	Shim Screw	Wrench
SRGPR/L 2020B-L12E	20	20	140	25	20	20	RPGT1203M0	FTKA0410	SR1203S	SHXN0609F	TW15P
2020B-L16E	20	20	140	25	20	20	RPGT1604M0	FTNA0513	SR16T3S	SHXN0712F	TW20P
2525B-L20E	25	25	140	32	25	30	RPGT2004M0	FTNA0513	SR20T3S	SHXN0712F	TW20P

SRGP...F Type



RPGT1203M0
RPGT1604M0
RPGT2004M0



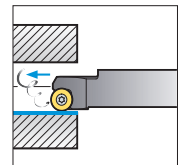
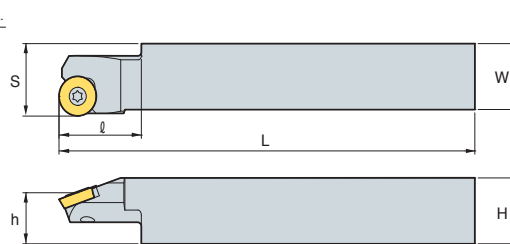
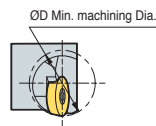
• R type insert
(mm)

Designation	H	W	L	S	h	l	Insert	Screw	Shim	Shim Screw	Wrench
SRGPR/L 2020B-L12F	20	20	140	25	20	20	RPGT1203M0	FTKA0410	SR1203S	SHXN0609F	TW15P
2020B-L16F	20	20	140	25	20	20	RPGT1604M0	FTNA0513	SR16T3S	SHXN0712F	TW20P
2525B-L20F	25	25	140	32	25	30	RPGT2004M0	FTNA0513	SR20T3S	SHXN0712F	TW20P

SRCP...B Type



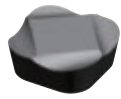
RPGT0802M0
RPGT1203M0
RPGT1604M0



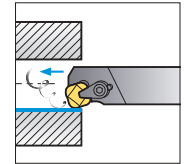
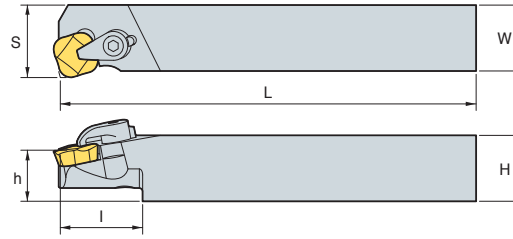
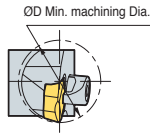
• R type insert
(mm)

Designation	ØD	H	W	L	S	h	l	Insert	Screw	Wrench
SRCPR/L 2020B-L08B-D12	12	20	20	140	21.5	15.5	25	RPGT0802M0	FTKA0305	TW09P
1919B-L12B-D15	15	19	19	140	21	16	25	RPGT1203M0	FTNA0408	TW15P
2020B-L12B-D20	20	20	20	140	22	15.5	25	RPGT1203M0	FTNA0408	TW15P
2525B-L16B-D32	32	25	25	140	27	20	30	RPGT1604M0	FTKA0510	TW20P

CSKP...B Type



SPGR120440L



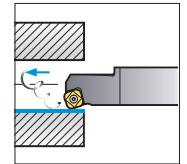
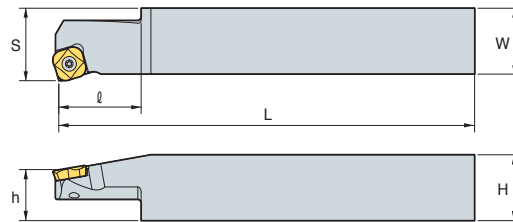
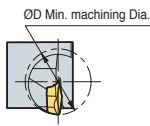
• R type insert
(mm)

Designation	ØD	H	W	L	S	h	l	Insert	Clamp	Clamp Screw	Wrench
CSKPR/L 2022B-L12B-D30	30	20	22	140	27	20	37	SPGR120440R/L			

SSKP...B Type



SPGH090330L



• R type insert
(mm)

Designation	ØD	H	W	L	S	h	l	Insert	Screw	Wrench
SSKPR/L 2020B-L09B-D12	12	20	20	140	21.7	19	20	SPGH090330R/L		
2020B-L09B-D13	13	20	20	140	21.7	19	20			
2020B-L09B-D20	20	20	20	140	21.7	19	20			

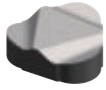
Insert

Application	Picture	Designation	Cermet	Dimensions (mm)				Configuration
			CN2500	r	d	d ₁	t	
Internal turning		RPGT0802M0		-	8	3.4	2.38	
		RPGT1203M0		-	12	4.4	3.18	
		RPGT1604M0		-	16	5.5	4.76	
		RPGT2004M0		-	20	5.5	4.76	
		SPGR120440L		4.0	12.7	-	4.76	
		SPGH090330L		3.0	9.525	3.4	3.18	

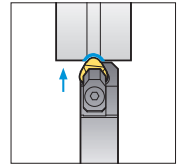
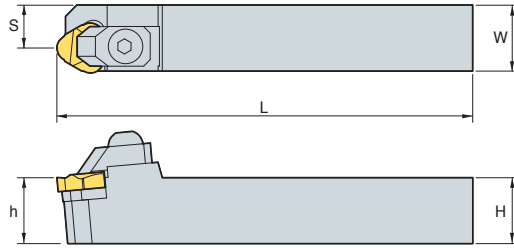
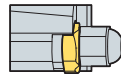
• Stock item



CKFN...RW Type



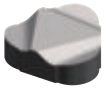
KORIC



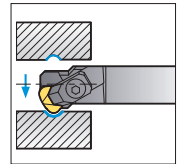
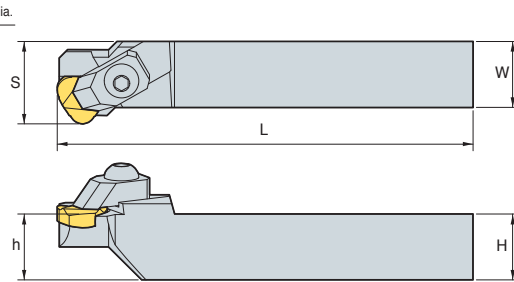
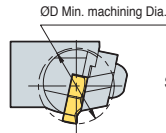
• R type insert (mm)

Designation	H	W	L	S	h	Insert	Clamp	Clamp Screw	Shim	Shim Screw	Wrench
CKFNR/L 2020B-L22RW	20	20	140	12.5	20	KORIC2204R/L	CH6N1B	BHA0620	ST42CB	SS0408	HW50L
2022B-L27RW	20	22	140	13	20	KORIC2704R/L	CH8R/L1B	BHA0820	ST52CB	SS0408	HW60L
2025B-L33RW	20	25	140	16	20	KORIC3306R/L	CH8R/L1B	BHA0820	ST62CB	SS0408	HW60L
2533B-L44RW	25	33	140	21	25	KORIC4408R/L	CH8R/L1B	BHA0820	ST82CB	SS0408	HW60L

CKGN...RW Type



KORIC



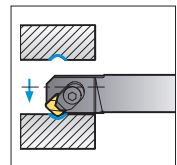
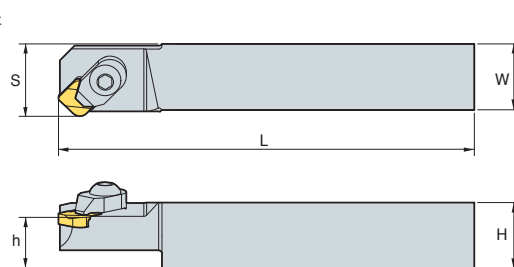
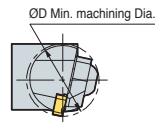
• R type insert (mm)

Designation	ØD	H	W	L	S	h	Insert	Clamp	Clamp Screw	Shim	Shim Screw	Wrench
CKGNR/L 2022B-L22RW-D23	23	20	22	140	30	20	KORIC2204R/L	CH6R/L3B	BHA0620	ST42CB	SS0408	HW50L
2022B-L27RW-D29	29	20	22	140	34	20	KORIC2704R/L	CH6R/L7B	BHA0620	ST52CB	SS0408	HW50L
2025B-L33RW-D38	38	20	25	140	33	20	KORIC3306R/L	CH6R/L5B	BHA0620	ST62CB	SS0408	HW50L
2528B-L38RW-D50	50	25	28	140	46	25	KORIC3806R/L	CH8R/L2B	BHA0820	ST72CB	SS0408	HW60L
2528B-L44RW-D52	52	25	28	140	50	25	KORIC4408R/L	CH8R/L2B	BHA0820	ST82CB	SS0408	HW60L

CSGN...RW Type



SNGN



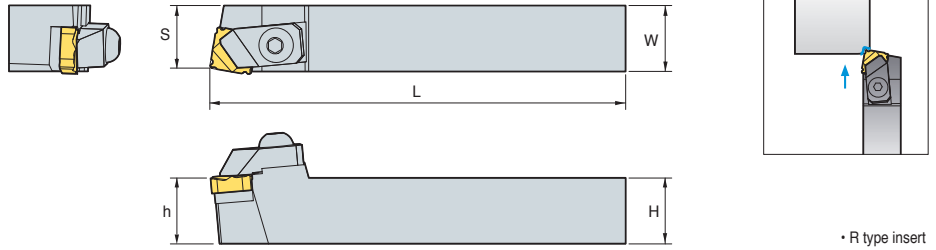
• R type insert (mm)

Designation	ØD	H	W	L	S	h	Insert	Clamp	Clamp Screw	Wrench
CSGNR/L 2020B-L09RW-D17	17	20	20	140	22	20	SNGN0903WR/L	CH5R1	CHX0510	HW30L
2020B-L09RW-D22	22	20	20	140	22	20	SNGN0903WR/L	CH5R1	CHX0510	HW30L



B Bearing Solution

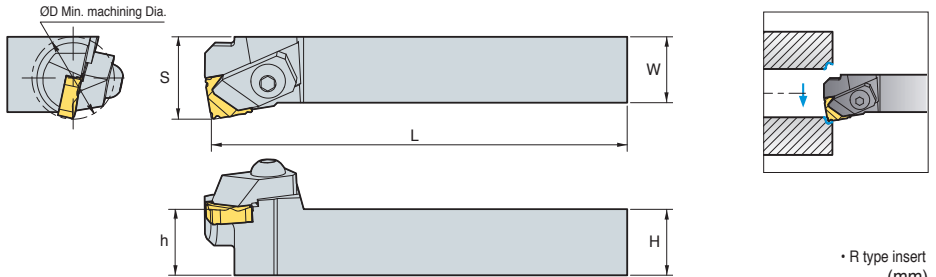
CSBN...BS Type



• R type insert (mm)

Designation	H	W	L	S	h	Insert	Clamp	Clamp Screw	Shim	Shim Screw	Wrench
CSBNR/L 2023B-L12BS	20	23	140	21	20	SNGN1204SR/L	CH6N1B	BHA0620	SS42CB	SS0308	HW50L
2525B-L15BS	25	25	140	23	25	SNGN1504SR/L	CH6N1B	BHA0620	SS52CB	SS0408	HW50L

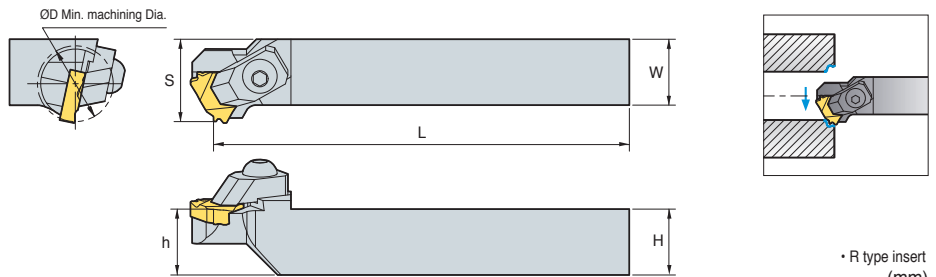
CSKN...BS Type



• R type insert (mm)

Designation	ØD	H	W	L	S	h	Insert	Clamp	Clamp Screw	Shim	Shim Screw	Wrench
CSKNR/L 1622B-L09BS-D14	14	16	22	140	16	16	SNGN0903SR/L	CH6R/L2B	BHA0620	-	-	HW50L
2022B-L12BS-D26	26	20	22	140	27	20	SNGN1204SR/L	CH6R/L1B	BHA0620	SS42CB	SS0308	HW50L
2525B-L15BS-D35	35	25	25	140	31	25	SNGN1504SR/L	CH6R/L3B	BHA0620	SS52CB	SS0408	HW50L

CTGN...BS Type



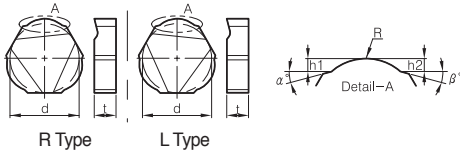
• R type insert (mm)

Designation	ØD	H	W	L	S	h	Insert	Clamp	Clamp Screw	Shim	Shim Screw	Wrench
CTGNR/L 2021B-K22BS-D25	25	20	21	140	30	20	TNGN2204SR/L	CH6R/L7B	BHA0620	ST42CB	SS0408	HW50L



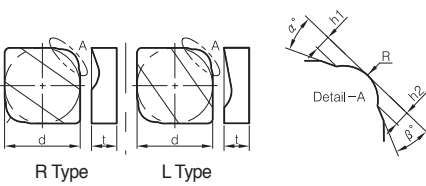
Machining Race-way

KORIC... R/L Type



		d	t	R	h ₁	h ₂	α°	β°
KORIC	2204R/L	12.7	4.76					
	2704R/L	15.875	4.76					
	3306R/L	19.05	6.0					
	3806R/L	22.225	6.0					
	4408R/L	25.4	8.0					

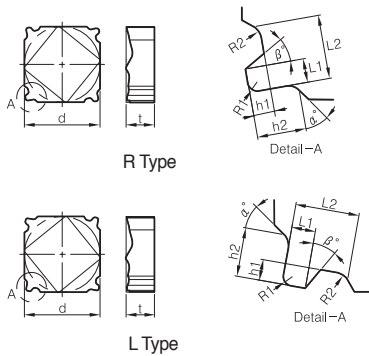
SNGN... WR/L Type



		d	t	R	h ₁	h ₂	α°	β°
SNGN	0903WR/L	9.525	3.18					
	1504WR/L	15.875	4.76					
	1905WR/L	19.05	5.56					

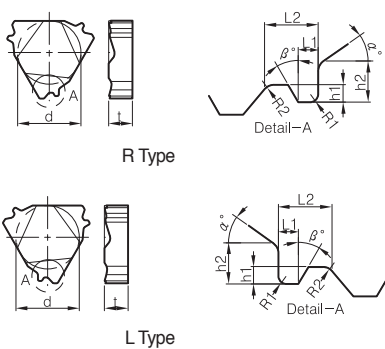
Machining for Bearing shield

KORIC... R/L Type



		d	t	L ₁	L ₂	h ₁	h ₂	R ₁	R ₂	α°	β°
SNGN	0903SR/L	9.525	3.18								
	1204SR/L	12.7	4.76								
	1504SR/L	15.875	4.76								

TNGN...SR/L Type



		d	t	L ₁	L ₂	h ₁	h ₂	R ₁	R ₂	α°	β°
TNGN	02204SR/L	12.7	4.76								

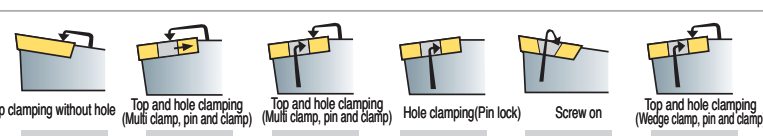
B External tool Holder Code System (ISO)

P S K N R 25 25 - M 12

1 Clamping Method of Insert 2 Insert Shape 3 Holder Style 4 Clearance Angle of Insert 5 Hand 6 Height of Shank 7 Width of Shank 8 Length of Holder 9 Length of Insert Cutting Edge

1 Clamping Method of Insert

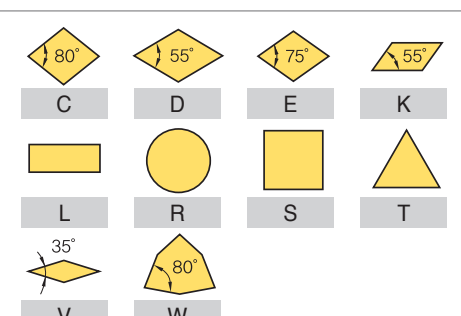
P S K N R 25 25 - M 12



Top clamping without hole (C) Top and hole clamping (Multi clamp, pin and clamp) (D) Top and hole clamping (Multi clamp, pin and clamp) (M) Hole clamping (Pin lock) (P) Screw on (S) Top and hole clamping (Wedge clamp, pin and clamp) (W)

2 Insert Shape

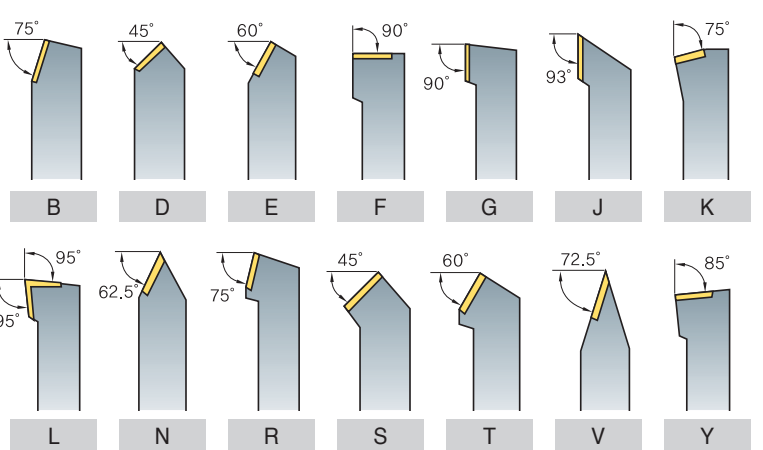
P S K N R 25 25 - M 12



C (80°) D (55°) E (75°) K (55°)
L R S T
V (35°) W (80°)

3 Holder Style

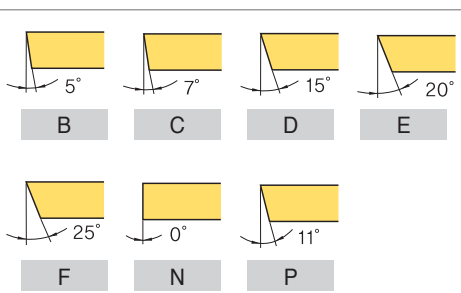
P S K N R 25 25 - M 12



B (75°) D (45°) E (60°) F (90°) G (90°) J (93°) K (75°)
L (95°) N (62.5°) R (75°) S (45°) T (60°) V (72.5°) Y (85°)

4 Clearance Angle of Insert

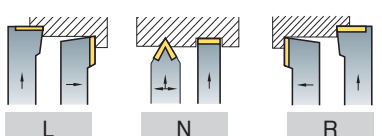
P S K N R 25 25 - M 12



B (5°) C (7°) D (15°) E (20°)
F (25°) N (0°) P (11°)

5 Hand

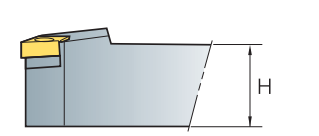
P S K N R 25 25 - M 12



L N R

6 Height of Shank

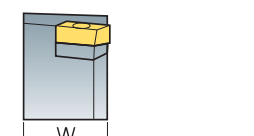
P S K N R 25 25 - M 12



H

7 Width of Shank

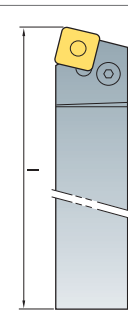
P S K N R 25 25 - M 12



W

8 Length of Holder

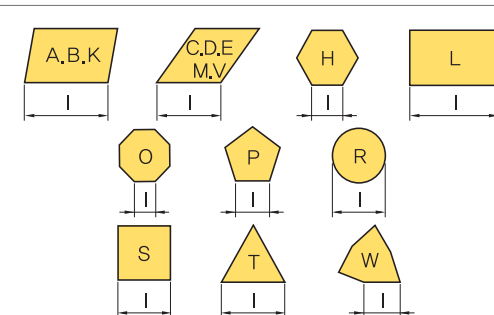
P S K N R 25 25 - M 12



A-32	H-100	Q-180	X-Special Item
B-40	J-110	R-200	
C-50	K-125	S-250	
D-60	L-140	T-300	
E-70	M-150	U-350	
F-80	N-160	V-400	
G-90	P-170	W-450	

9 Length of Insert Cutting Edge

P S K N R 25 25 - M 12



A,B,K C,D,E,M,V H L
O P R
S T W



Double Clamp System

Cutting Shape										
Designation	DCBNR/L	DCKNR/L	DCLNR/L	DDJNR/L	DSBNR/L	DSDNN	DSKNR/L	DSSNR/L	DTFNR/L	DTGNR/L
Approach angle	75°	75°	95°	93°	75°	45°	75°	45°	90°	90°
Page	B167	B167	B167	B168	B168	B169	B169	B169	B170	B170
Turning	●		●	●	●	●		●		●
Copying				●						
Facing		●	●				●	●	●	
Chamfering						●				
Back turning			●	●						
Cutting Shape										
Designation	DVJNR/L	DVVNN	DWLNR/L							
Approach angle	93°	72.5°	95°							
Page	B170	B171	B171							
Turning	●	●	●							
Copying	●	●								
Facing			●							
Chamfering										
Back turning	●		●							

Lever Lock System

Cutting Shape										
Designation	PCBNR/L	PCKNR/L	PCLNR/L	PDJNR/L	PDNNR/L	PRDCN	PRGCR/L	PSBNR/L	PSDNN	PSKNR/L
Approach angle	75°	75°	95°	93°	62.5°	-	-	75°	45°	75°
Page	B172	B172	B173	B173	B174	B174	B175	B175	B176	B176
Turning	●	●	●	●	●	●	●	●	●	
Copying				●	●	●	●			
Facing			●							●
Chamfering										
Back turning			●	●						
Cutting Shape										
Designation	PSSNR/L	PTFNR/L	PTGNR/L	PTTNR/L	PWLNR/L					
Approach angle	45°	90°	90°	60°	95°					
Page	B177	B177	B178	B178	B178					
Turning	●		●	●	●					
Copying										
Facing	●	●			●					
Chamfering				●						
Back turning					●					

Wedge Clamp System

Cutting Shape										
Designation	WTENN	WTJNR/L	WTXNR/L	WWLNR/L						
Approach angle	60°	93°	105°	95°						
Page	B179	B179	B179	B180						
Turning	●	●	●	●						
Copying	●	●	●							
Facing				●						
Chamfering										
Back turning		●	●	●						

Clamp on System

Cutting Shape										
Designation	CKJNR/L	CKNNR/L	CSDPN	CSKPR/L	CTFPR/L	CTGPR/L				
Approach angle	93°	62.5°	45°	75°	90°	90°				
Page	B181	B181	B181	B182	B182	B182				
Turning	●	●	●			●				
Copying	●	●								
Facing				●	●					
Chamfering										
Back turning	●									

Multi Lock System

Cutting Shape										
Designation	MCKNR/L	MCLNR/L	MCMNN	MCRNR/L	MDJNR/L	MDNNN	MDQNR/L	MSBNR/L	MSDNN	MSKNR/L
Approach angle	75°	95°	50°	75°	93°	62.5°	107.5°	75°	45°	75°
Page	B183	B183	B183	B184	B184	B184	B185	B185	B185	B186
Turning		●	●	●	●	●	●	●	●	
Copying					●	●	●			
Facing	●	●								●
Chamfering										
Back turning		●			●		●			

Cutting Shape										
Designation	MSRNR/L	MSSNR/L	MTENN	MTFNR/L	MTGNR/L	MTJNR/L	MVJNR/L	MVQNR/L	MVVNN	MWLNR/L
Approach angle	75°	45°	60°	90°	90°	93°	93°	117.5°	72.5°	95°
Page	B186	B187	B187	B187	B188	B188	B188	B189	B189	B189
Turning	●	●	●		●	●	●	●	●	●
Copying			●			●	●	●	●	
Facing		●		●		●				●
Chamfering										
Back turning						●	●	●		●



Screw on System

Cutting Shape										
Designation	SCACR/L	SCLCR/L	SDACR/L	SDJCR/L	SDNCN	SRDCN	SRGCR/L	SSBCR/L	SSDCN	SSKCR/L
Approach angle	90°	95°	90°	93°	62.5°	-	-	75°	45°	75°
Page	B190	B190	B190	B191	B191	B191	B192	B192	B192	B193
Turning	●	●	●	●	●	●	●	●	●	
Copying			●	●	●	●	●			
Facing		●								●
Chamfering										
Back turning		●		●						

Cutting Shape										
Designation	SSSCR/L	STACR/L	STFCR/L	STGCR/L	STTCR/L	SVABR/L	SVHBR/L	SVJBR/L	SVJCR/L	SVVBN
Approach angle	45°	90°	90°	90°	60°	90°	107.5°	93°	93°	72.5°
Page	B193	B193	B194	B194	B194	B195	B195	B195	B196	B196
Turning	●	●		●	●	●	●	●	●	●
Copying						●	●	●	●	●
Facing	●		●							
Chamfering										
Back turning						●	●	●	●	

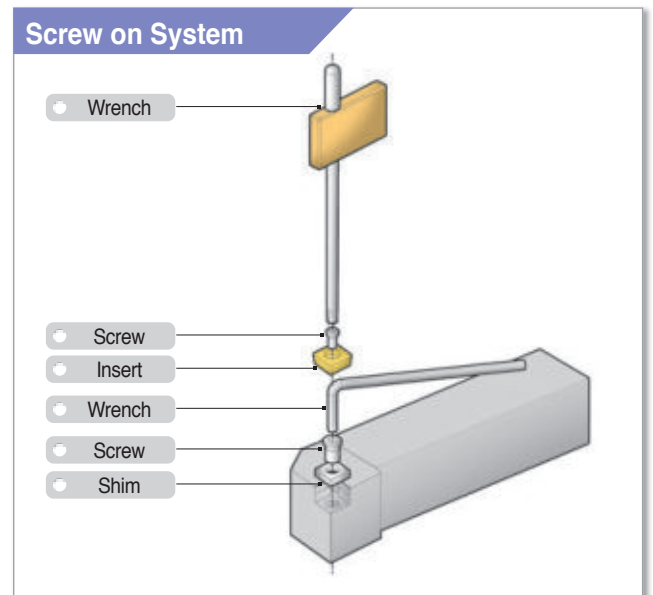
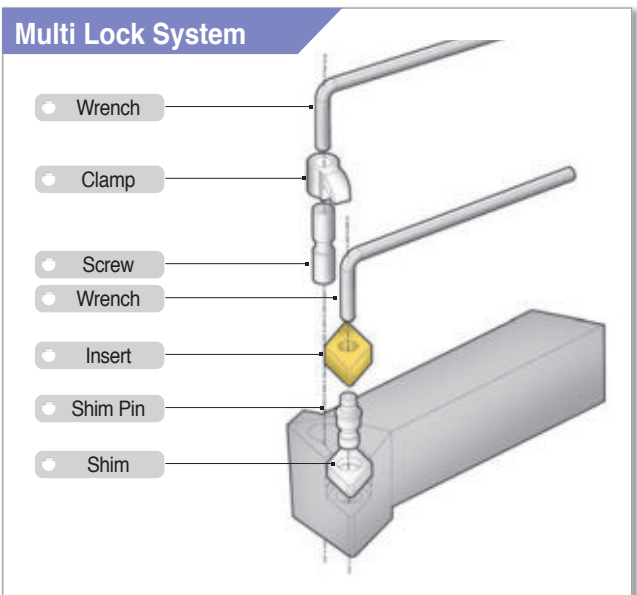
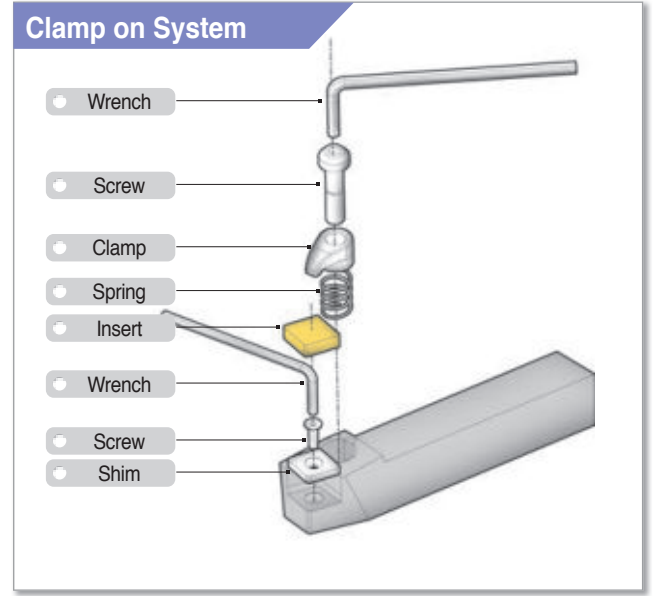
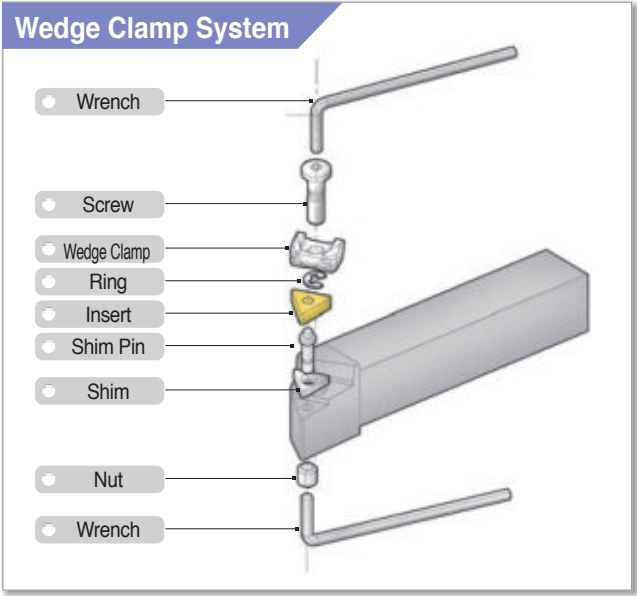
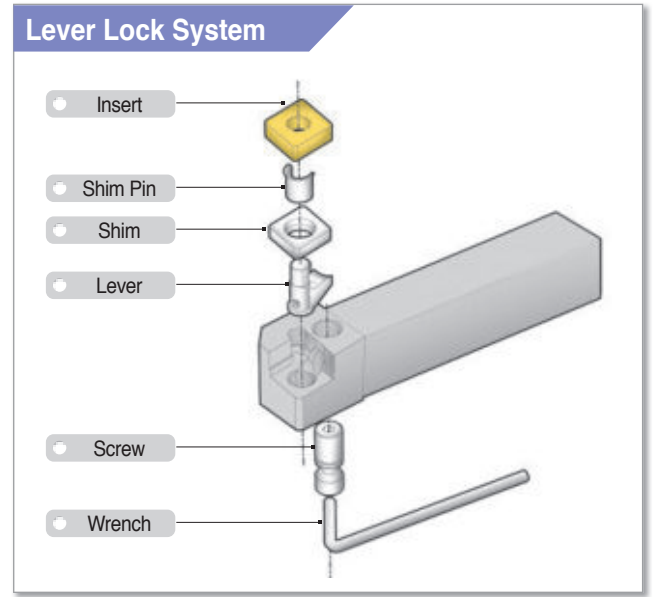
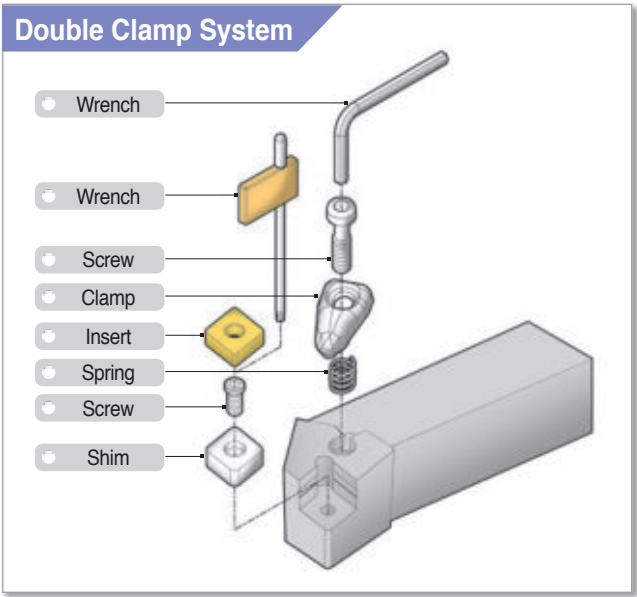
Cutting Shape										
Designation	SVVCN									
Approach angle	72.5°									
Page	B196									
Turning	●									
Copying	●									
Facing										
Chamfering										
Back turning										

Ceramic Holder

Cutting Shape										
Designation	CCNLR/L	CRDNN	CRGNR/L	CSDNN	CSKNR/L	CTFNR/L	CTGNR/L			
Approach angle	95°	-	-	45°	75°	90°	90°			
Page	B197	B197	B197	B197	B198	B198	B198			
Turning	●	●	●	●			●			
Copying			●							
Facing	●				●	●				
Chamfering										
Back turning	●									



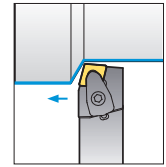
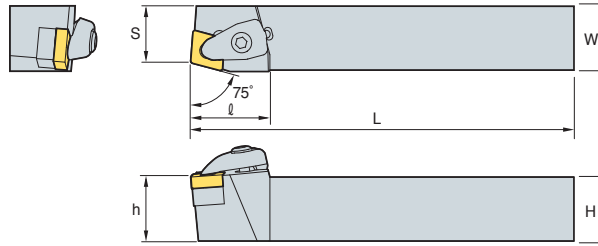
Instruction of External Holder



DCBNR/L



CN□□



75°

• R type insert (mm)

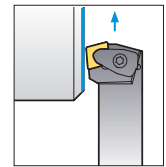
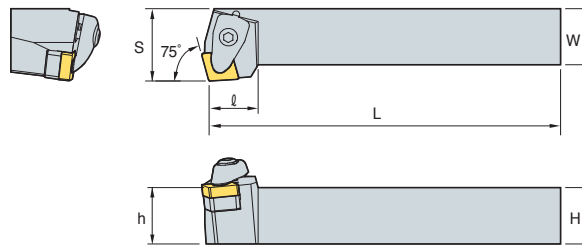
Designation	H	W	L	S	h	ℓ	Insert	Clamp	Clamp Screw	Shim	Shim Screw	Spring	Wrench							
DCBNR/L	2020-K12	20	20	125	17	20	CN□□1204□□													
	2525-M12	25	25	150	22	25								CVH4	CHX0518	SC44V	FTKA0410	SPR0714	HW30P	
	3225-P12	32	25	170	22	32								31						
DCBNR/L	2525-M16	25	25	150	22	25	CN□□1606□□													
	3232-P16	32	32	170	27	32								36	CVH5	CHX0622	SC54V	FTNA0511	SPR0811	HW40L
	3232-P19	32	32	170	27	32								40						
DCBNR/L	4040-S19	40	40	250	35	40	CN□□1906□□													

⇒ Applicable inserts B36~B42

DCKNR/L



CN□□



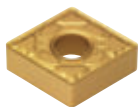
75°

• R type insert (mm)

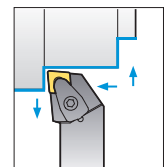
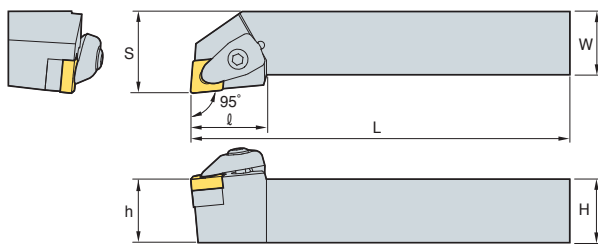
Designation	H	W	L	S	h	ℓ	Insert	Clamp	Clamp Screw	Shim	Shim Screw	Spring	Wrench							
DCKNR/L	2020-K12	20	20	125	25	20	CN□□1204□□													
	2525-M12	25	25	150	32	25								21	CVH4	CHX0518	SC44V	FTKA0410	SPR0714	HW30P
	3225-P12	32	25	170	32	32								21						
DCKNR/L	3232-P16	32	32	170	40	32	CN□□1606□□													
	4040-S16	40	40	250	50	40								26	CVH5	CHX0622	SC54V	FTNA0511	SPR0811	HW40L

⇒ Applicable inserts B36~B42

DCLNR/L



CN□□



95°

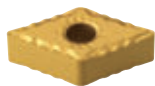
• R type insert (mm)

Designation	H	W	L	S	h	ℓ	Insert	Clamp	Clamp Screw	Shim	Shim Screw	Spring	Wrench							
DCLNR/L	2020-K09	20	20	125	25	20	CN□□0903□□													
	2525-M09	25	25	150	32	25								24.5	CVH3	CHX0415	SC32V	FTKA0307	SPR0510	HW25P
	2020-K12	20	20	125	25	20								30						
DCLNR/L	2525-M12	25	25	150	32	25	CN□□1204□□													
	3225-P12	32	25	170	32	32								30	CVH4	CHX0518	SC44V	FTKA0410	SPR0714	HW30P
	3232-P12	32	32	170	40	32								30						
DCLNR/L	2525-M16	25	25	150	32	25	CN□□1606□□													
	3225-P16	32	25	170	32	32								36	CVH5	CHX0622	SC54V	FTNA0511	SPR0811	HW40L
	3232-P16	32	32	170	40	32								36						
DCLNR/L	2525-M19	25	25	150	32	25	CN□□1906□□													
	3225-P19	32	25	170	32	32								40	CVH6	CHX0622	SC63V	FTNA0511	SPR0811	HW40L
	3232-P19	32	32	170	40	32								40						
	4040-S19	40	40	250	50	40								40						

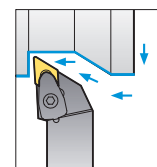
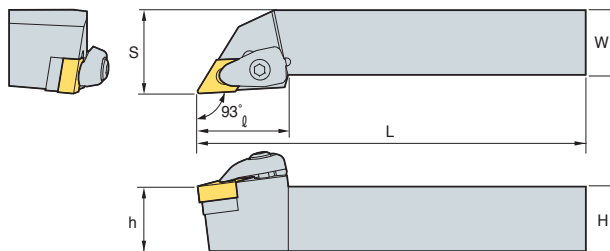
⇒ Applicable inserts B36~B42

B Double Clamp System

DDJNR/L



DN□□



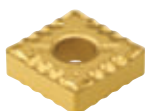
93°

• R type insert (mm)

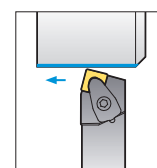
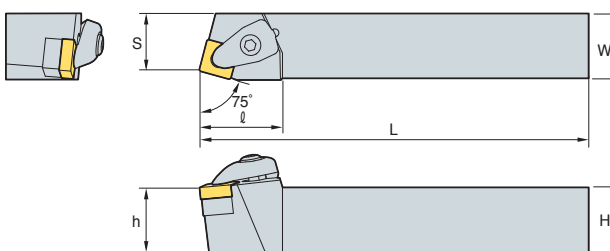
Designation	H	W	L	S	h	ℓ	Insert	Clamp	Clamp Screw	Shim	Shim Screw	Spring	Wrench
DDJNR/L 2020-K11	20	20	125	25	20	30	DN□□1104□□						
2525-M11	25	25	150	32	25	30							
3225-P11	32	25	170	32	32	30							
3232-P11	32	32	170	40	32	30	DN□□1506□□						
2020-K15	20	20	125	25	20	35							
2525-M15	25	25	150	32	25	35							
3225-P15	32	25	170	32	32	35							
3232-P15	32	32	170	40	32	35	DN□□1504□□						
2020-K15-3	20	20	125	25	20	35							
2525-M15-3	25	25	150	32	25	35							
3232-P15-3	32	32	170	40	32	35							

➔ Applicable inserts B43~B48

DSBNR/L



SN□□



75°

• R type insert (mm)

Designation	H	W	L	S	h	ℓ	Insert	Clamp	Clamp Screw	Shim	Shim Screw	Spring	Wrench
DSBNR/L 2020-K09	20	20	125	17	20	25	SN□□0903□□						
2525-M09	25	25	150	22	25	25							
2020-K12	20	20	125	17	20	32	SN□□1204□□						
2525-M12	25	25	150	22	25	32							
3225-P12	32	25	170	22	32	32							
3232-P12	32	32	170	27	32	32	SN□□1506□□						
2525-M15	25	25	150	22	25	38							
3225-P15	32	25	170	22	32	38							
3232-P15	32	32	170	27	32	38							
3232-P19	32	32	170	27	32	43	SN□□1906□□						
4040-S19	40	40	250	35	40	43							

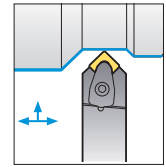
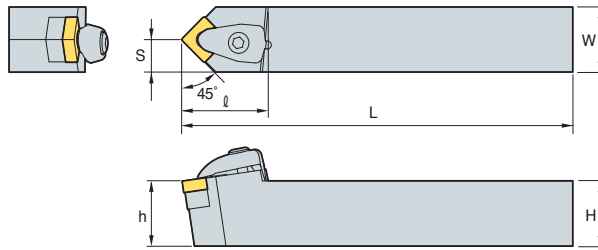
➔ Applicable inserts B50~B57



DSDNN



SN□□



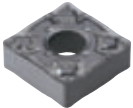
45°

• R type insert (mm)

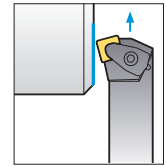
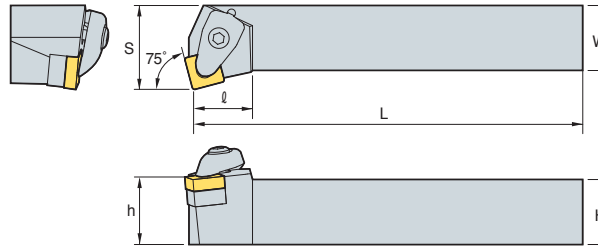
Designation	H	W	L	S	h	ℓ	Insert	Clamp	Clamp Screw	Shim	Shim Screw	Spring	Wrench	
DSDNN	2020-K09	20	20	125	10	20	26.5	SN□□0903□□	CVH3	CHX0415	SS32V	FTKA0307	SPR0510	HW25P
	2020-K12	20	20	125	10	20	33	SN□□1204□□	CVH4	CHX0518	SS44V	FTKA0410	SPR0714	HW30P
	2525-M12	25	25	150	12.5	25	33							
	3225-P12	32	25	170	12.5	32	33							
2525-M15	25	25	150	12.5	25	39.4	SN□□1506□□	CVH5	CHX0622	SS54V	FTNA0511	SPR0811	HW25P	
3232-P15	32	32	170	16	32	38	SN□□1906□□	CVH6	CHX0622	SS64V	FTNA0511	SPR0811	HW40L	
3232-P19	32	32	170	16	32	43								
4040-S19	40	40	250	20	40	45								

↻ Applicable inserts B50~B57

DSKNR/L



SN□□



75°

• R type insert (mm)

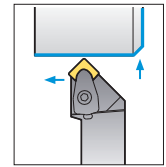
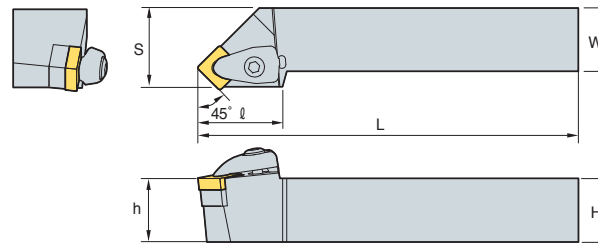
Designation	H	W	L	S	h	ℓ	Insert	Clamp	Clamp Screw	Shim	Shim Screw	Spring	Wrench	
DSKNR/L	2020-K09	20	20	125	25	20	20	SN□□0903□□	CVH3	CHX0415	SS32V	FTKA0307	SPR0510	HW25P
	2020-K12	20	20	125	25	20	23	SN□□1204□□	CVH4	CHX0518	SS44V	FTKA0410	SPR0714	HW30P
	2525-M12	25	25	150	32	25	23							
	3232-P12	32	32	170	40	32	23							
3232-P15	32	32	170	40	32	28	SN□□1506□□	CVH5	CHX0622	SS54V	FTNA0511	SPR0811	HW40L	
3232-P19	32	32	170	40	32	35	SN□□1906□□	CVH6	CHX0622	SC64V	FTNA0511	SPR0811	HW40L	
4040-S19	40	40	250	50	40	43								

↻ Applicable inserts B50~B57

DSSNR/L



SN□□



45°

• R type insert (mm)

Designation	H	W	L	S	h	ℓ	Insert	Clamp	Clamp Screw	Shim	Shim Screw	Spring	Wrench	
DSSNR/L	2020-K09	20	20	125	25	20	28.5	SN□□0903□□	CVH3	CHX0415	SS32V	FTKA0307	SPR0510	HW25P
	2020-K12	20	20	125	25	20	35	SN□□1204□□	CVH4	CHX0518	SS44V	FTKA0410	SPR0714	HW30P
	2525-M12	25	25	150	32	25	35							
	3225-P12	32	25	170	32	32	35							
3232-P12	32	32	170	40	32	35	SN□□1506□□	CVH5	CHX0622	SS54V	FTNA0511	SPR0811	HW40L	
2525-M15	25	25	150	32	25	38.5								
3232-P15	32	32	170	40	32	38.5								
3232-P19	32	32	170	40	32	46	SN□□1906□□	CVH6	CHX0622	SS64V	FTNA0511	SPR0811	HW40L	
4040-S19	40	40	250	50	40	46								

↻ Applicable inserts B50~B57

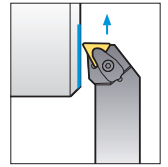
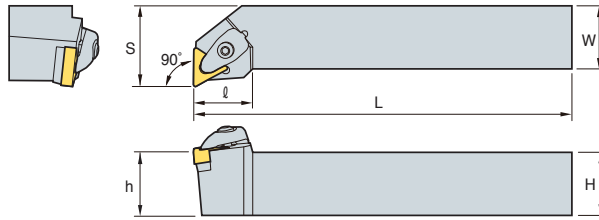


B Double Clamp System

DTFNR/L



TN□□



90°

• R type insert (mm)

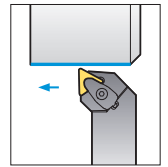
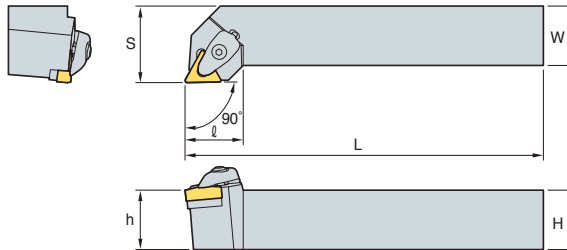
Designation	H	W	L	S	h	l	Insert	Clamp	Clamp Screw	Shim	Shim Screw	Spring	Wrench
DTFNR/L 2020-K16	20	20	125	25	20	24.5	TN□□1604□□						
2525-M16	25	25	150	32	25	24.5							
3232-P16	32	32	170	40	32	23.5							
2525-M22	25	25	150	32	25	33	TN□□2204□□						
3225-P22	32	25	170	32	32	33							
3232-P22	32	32	170	40	32	33							

↻ Applicable inserts B58~B65

DTGNR/L



TN□□



90°

• R type insert (mm)

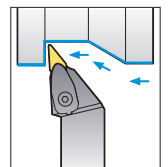
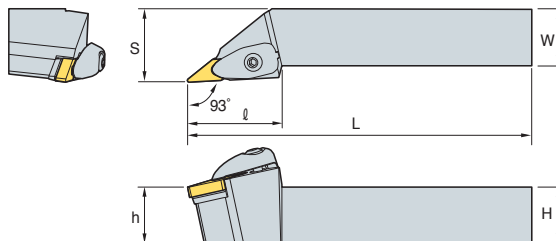
Designation	H	W	L	S	h	l	Insert	Clamp	Clamp Screw	Shim	Shim Screw	Spring	Wrench
DTGNR/L 2020-K16	20	20	125	25	20	24.5	TN□□1604□□						
2525-M16	25	25	150	32	25	24.5							
3232-P16	32	32	170	40	32	24.5							
2525-M22	25	25	150	32	25	32.6	TN□□2204□□						
3225-P22	32	25	170	32	32	32.6							
3232-P22	32	32	170	40	32	32.6							

↻ Applicable inserts B58~B65

DVJNR/L



VN□□



93°

• R type insert (mm)

Designation	H	W	L	S	h	l	Insert	Clamp	Clamp Screw	Shim	Shim Screw	Spring	Wrench
DVJNR/L 2020-K16	20	20	125	25	20	41.5	VN□□1604□□						
2525-M16	25	25	150	32	25	41.5							
3232-P16	32	32	170	40	32	41.5							

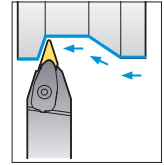
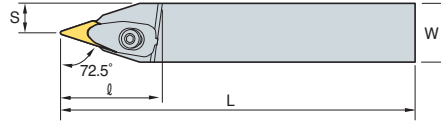
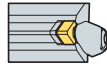
↻ Applicable inserts B66~B67



DVVNN



VN□□



72.5°

• R type insert (mm)

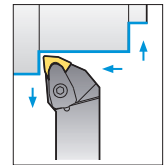
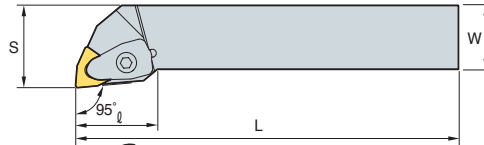
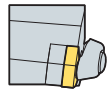
Designation		H	W	L	S	h	ℓ	Insert	Clamp	Clamp Screw	Shim	Shim Screw	Spring	Wrench
DVVNN	2020-K16	20	20	125	10	20	40	VN□□1604□□						
	2525-M16	25	25	150	12.5	25	40							
	3232-P16	32	32	170	16	32	40							

↻ Applicable inserts B66~B67

DWLNR/L



WN□□



95°

• R type insert (mm)

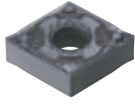
Designation		H	W	L	S	h	ℓ	Insert	Clamp	Clamp Screw	Shim	Shim Screw	Spring	Wrench
DWLNR/L	2020-K06	20	20	125	25	20	26	WN□□0604□□						
	2525-M06	25	25	150	32	25	26							
	2020-K08	20	20	125	25	20	32	WN□□0804□□						
	2525-M08	25	25	150	32	25	32							

↻ Applicable inserts B68~B72

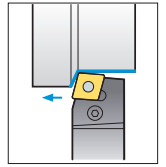
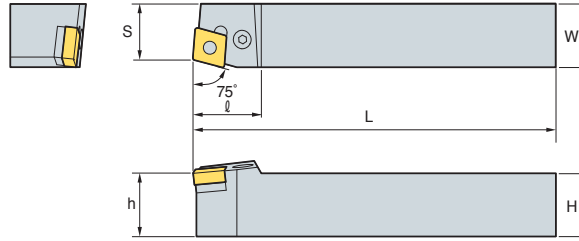


B Lever Lock System

PCBNR/L



CN□□



75°

• R type insert (mm)

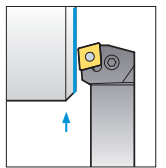
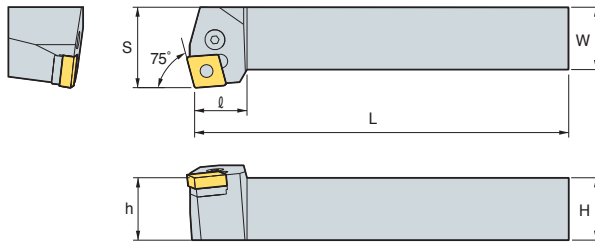
Designation	H	W	L	S	h	ℓ	Insert	Lever	Screw	Shim	Shim Pin	Wrench	Shim Pin Punch	
PCBNR/L 2020-K12	20	20	125	17	20	27	CN□□ 1204□□	LV4	VHX0821	SC42	SP4	HW30L	LSPS4	
	2525-M12	25	25	150	22	25								27
	3225-P12	32	25	170	22	32								27
PCBNR/L 2525-M16	25	25	150	22	25	33	CN□□ 1606□□	LV5	VHX0825	SC53	SP5	HW30L	LSPS6	
	3232-P16	32	32	170	27	32								33
PCBNR/L 3232-P19	32	32	170	27	32	36	CN□□ 1906□□	LV6N	VHX1027N	SC63N	SP6N	HW40L	LSPS6	
PCBNR/L 4040-S19	40	40	250	35	40	36	CN□□ 2509□□	LV8N	VHX1236N	SC84N	SP8N	HW50L	LSPS8	
PCBNR/L 4040-S25	40	40	250	35	40	47	CN□□ 2507□□							
PCBNR/L 4040-S25-5	40	40	250	35	40	47	CN□□ 2507□□	LV8N	VHX1236N	SC84N	SP8N	HW50L	LSPS8	
PCBNR/L 5050-T25	50	50	300	43	50	47	CN□□ 2509□□							

➔ Applicable inserts B36~B42

PCKNR/L



CN□□



95°

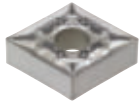
• R type insert (mm)

Designation	H	W	L	S	h	ℓ	Insert	Lever	Screw	Shim	Shim Pin	Wrench	Shim Pin Punch	
PCKNR/L 2020-K12	20	20	125	25	20	27	CN□□ 1204□□	LV4	VHX0821	SC42	SP4	HW30L	LSPS4	
	2525-M12	25	25	150	32	25								27
	3225-P12	32	25	170	40	32								30
PCKNR/L 3232-P16	32	32	170	40	32	26	CN□□ 1606□□	LV5	VHX0825	SC53	SP5	HW30L	HW30L	
PCKNR/L 4040-S16	40	40	250	50	40	25								

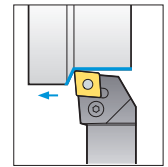
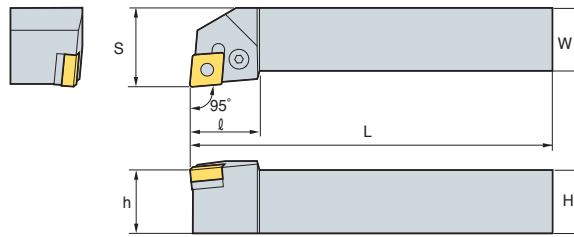
➔ Applicable inserts B36~B42



PCLNR/L



CN□□



95°

• R type insert
(mm)

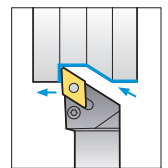
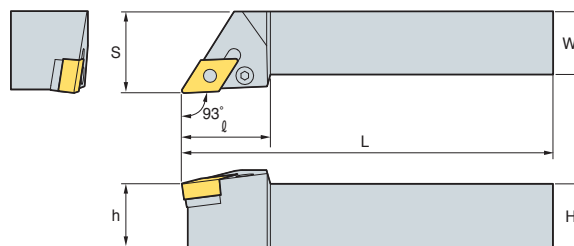
Designation	H	W	L	S	h	ℓ	Insert	Lever	Screw	Shim	Shim Pin	Wrench	Shim Pin Punch
PCLNR/L 1616-H09	16	16	100	20	16	20	CN□□ 0903□□	LV3	VHX0617	SC32	SP3	HW25L	LSPS3
2020-K09	20	20	125	25	20	22							
2525-M09	25	25	150	32	25	22							
1616-H12	16	16	100	20	16	28	CN□□ 1204□□	LV4	VHX0821	SC42	SP4	HW30L	LSPS4
2020-K12	20	20	125	25	20	28							
2525-M12	25	25	150	32	25	28							
3225-P12	32	25	170	32	32	28							
3232-P12	32	32	170	40	32	28	CN□□ 1606□□	LV5	VHX0825	SC53	SP5	HW30L	LSPS5
2525-M16	25	25	150	32	25	33							
3232-P16	32	32	170	40	32	33							
2525-M19	25	25	150	32	25	36	CN□□ 1906□□	LV6N	VHX1027N	SC63N	SP6N	HW40L	LSPS6
3225-P19	32	25	170	32	32	36							
3232-P19	32	32	170	40	32	36							
4040-P19	40	40	170	50	40	36							
4040-S19	40	40	250	50	40	36	CN□□ 2509□□	LV8N	VHX1236N	SC84N	SP8N	HW50L	LSPS8
4040-S25	40	40	250	50	40	47							
5050-T25	50	50	300	60	50	47							
4040-S25-5	40	40	250	50	40	47	CN□□ 2507□□	LV8N	VHX1236N	SC84N	SP8N	HW50L	LSPS8
5050-S25-5	50	50	300	60	50	47							

↻ Applicable inserts B36~B42

PDJNR/L



DN□□



93°

• R type insert
(mm)

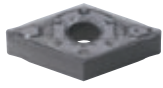
Designation	H	W	L	S	h	ℓ	Insert	Lever	Screw	Shim	Shim Pin	Wrench	Shim Pin Punch
PDJNR/L 1616-H11	16	16	100	20	16	25	DN□□ 1104□□	LV3	VHX0617	SD317	SP3	HW25L	LSPS3
2020-K11	20	20	125	25	20	25							
2525-M11	25	25	150	32	25	30							
2020-K15	20	20	125	25	20	35	DN□□ 1506□□	LV4B	VHX0821	SD42	SP4	HW30L	LSPS4
2525-M15	25	25	150	32	25	35							
3225-P15	32	25	170	32	32	35							
3232-P15	32	32	170	40	32	35							
2020-K15-3	20	20	125	25	20	35	DN□□ 1504□□	LV4	VHX0821	SD42	SP4	HW30L	LSPS4
2525-M15-3	25	25	150	32	25	35							
3232-P15-3	32	32	170	40	32	35							

↻ Applicable inserts B43~B48

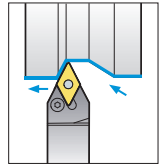
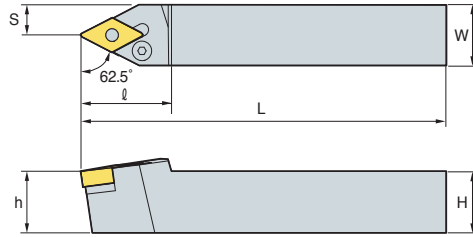


B Lever Lock System

PDNNR/L



DN□□



62.5°

• R type insert (mm)

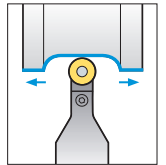
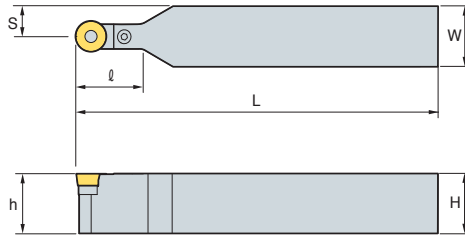
Designation	H	W	L	S	h	ℓ	Insert	Lever	Screw	Shim	Shim Pin	Wrench	Shim Pin Punch						
PDNNR/L	2020-K15	20	20	125	8	20	DN□□ 1506□□												
	2525-M15	25	25	150	12.5	25								LV4B	VHX0821	SD42	SP4	HW30L	LSPS4
	3232-P15	32	32	150	16	32								LV4	VHX0821	SD42	SP4	HW30L	LSPS4
	4025-M15	40	25	170	12.5	32								LV4	VHX0821	SD42	SP4	HW30L	LSPS4
PDNNR/L	2525-M15-3	25	25	150	12.5	25	DN□□ 1504□□												
	4025-M15-3	40	25	150	12.5	25								LV4	VHX0821	SD42	SP4	HW30L	LSPS4

↻ Applicable inserts B43~B48

PRDCN



RCMX



(mm)

Designation	H	W	L	S	h	ℓ	Insert	Lever	Screw	Shim	Shim Pin	Wrench	Shim Pin Punch
PRDCN	2020-M10	20	20	150	10	20	RCMX1003M0						
	2525-M10	25	25	150	12.5	25							
PRDCN	2525-M12	25	25	150	12.5	25	RCMX1204M0						
	2020-K12	20	20	125	10	20							
PRDCN	3225-Q12	32	25	180	12.5	32	RCMX1606M0						
	2525-Q16	25	25	180	12.5	25							
PRDCN	3225-Q16	32	25	180	12.5	32	RCMX2006M0						
	3232-Q16	32	32	180	16	32							
PRDCN	3232-Q20	32	32	180	16	32	RCMX2507M0						
	4040-S25	40	40	250	20	40							
PRDCN	4040-T25	40	40	300	20	40	RCMX3209M0						
PRDCN	5050-U32	50	50	350	25	50	RCMX3209M0	LR32	VHX1236	SR32	SP8N	HW50L	LSPS8

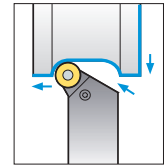
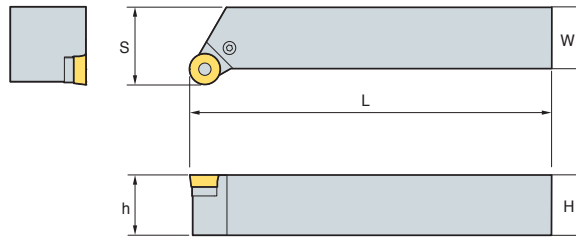
↻ Applicable inserts B83, B105



PRGCR/L



RCMX



• R type insert (mm)

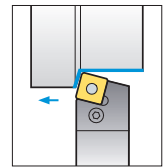
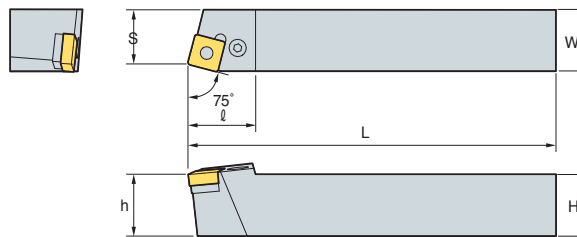
Designation	H	W	L	S	h	Insert	Lever	Screw	Shim	Shim Pin	Wrench	Shim Pin Punch
PRGCR/L 2020-K10	20	20	125	25	20	RCMX1003M0	LR10	VHX0514	SR10	SP3	HW20L	LSPS3
	25	25	150	32	25							
2020-K12	20	20	125	25	20	RCMX1204M0	LR12	VHX0617	SR12	SP3	HW25L	LSPS3
	25	25	150	32	25							
3225-P12	32	25	170	32	32	RCMX1606M0	LR16	VHX0621	SR16	SP4	HW25L	LSPS4
2525-M16	25	25	150	32	25							
3225-P16	32	25	170	32	32	RCMX2006M0	LR20	VHX0823	SR20	SP5-1	HW30L	LSPS5
3232-P20	32	32	170	40	32							
4040-S25	40	40	250	50	40	RCMX2507M0	LR25	VHX1030	SR25	SP6N	HW40L	LSPS6

➔ Applicable inserts B83, B105

PSBNR/L



SN□□



75°

• R type insert (mm)

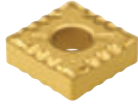
Designation	H	W	L	S	h	l	Insert	Lever	Screw	Shim	Shim Pin	Wrench	Shim Pin Punch
PSBNR/L 1616-H09	16	16	100	13	16	21	SN□□0903□□	LV3	VHX0617	SS32	SP3	HW25L	LSPS3
	20	20	125	17	20	23							
2020-K09	20	20	125	17	20	28	SN□□1204□□	LV4	VHX0821	SS42	SP4	HW30L	LSPS4
2020-K12	20	20	125	17	20	28							
2525-M12	25	25	150	22	25	28							
3225-P12	32	25	170	22	32	28							
3232-P12	32	32	170	27	32	28	SN□□1506□□	LV5	VHX0825	SS53	SP5	HW30L	LSPS5
2525-M15	25	25	150	22	25	35							
3232-P15	32	32	170	27	32	35	SN□□1906□□	LV6N	VHX1027N	SS63N	SP6N	HW40L	LSPS6
3232-P19	32	32	170	27	32	40							
4040-S19	40	40	250	35	40	40	SN□□2507□□	LV8N	VHX1236N	SS84N	SP8N	HW50L	LSPS8
4040-S25	40	40	250	35	40	50							
4040-S25-6	40	40	250	35	40	50	SN□□2509□□	LV8N	VHX1236N	SS84N	SP8N	HW50L	LSPS8
5050-T25	50	50	300	43	50	50	SN□□2507□□						
5050-T25-6	50	50	300	43	50	46	SN□□2509□□						

➔ Applicable inserts B50~B57

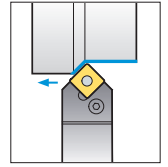
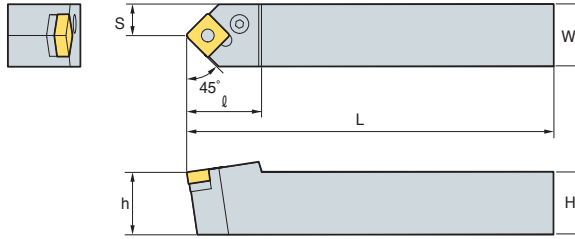


B Lever Lock System

PSDNN



SN□□



45°

(mm)

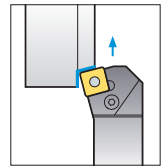
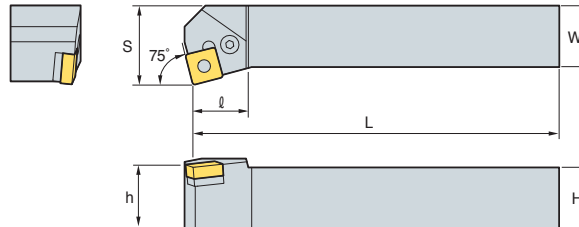
Designation	H	W	L	S	h	ℓ	Insert	Lever	Screw	Shim	Shim Pin	Wrench	Shim Pin Punch	
PSDNN	1616-H09	16	16	100	8	16	23	SN□□0903□□	LV3	VHX0617	SS32	SP3	HW25L	LSPS3
	2020-K12	20	20	125	10	20	30	SN□□1204□□	LV4	VHX0821	SS42	SP4	HW30L	LSPS4
	2525-M12	25	25	150	12.5	25	30							
	3225-P12	32	25	170	12.5	32	30							
	3232-P12	32	32	170	16	32	40							
	2525-M15	25	25	150	12.5	25	40	SN□□1506□□	LV5	VHX0825	SS53	SP5	HW30L	LSPS5
	3232-P15	32	32	170	16	32	40	SN□□1906□□	LV6N	VHX1027N	SS63N	SP6N	HW40L	LSPS6
	3225-P19	32	25	170	12.5	32	40							
	3232-P19	32	32	170	16	32	40							
	4040-S19	40	40	250	20	40	40							
	4040-S25	40	40	250	20	40	50	SN□□2507□□	LV8N	VHX1236N	SS84N	SP8N	HW50L	LSPS8
	5050-T25	50	50	300	25	50	50	SN□□2509□□	LV8N	VHX1236N	SS84N	SP8N	HW50L	LSPS8
	4040-S25-6	40	40	250	20	40	50							
	5050-T25-6	50	50	300	25	50	50							

↻ Applicable inserts B50~B57

PSKNR/L



SN□□



75°

• R type insert
(mm)

Designation	H	W	L	S	h	ℓ	Insert	Lever	Screw	Shim	Shim Pin	Wrench	Shim Pin Punch	
PSKNR/L	1616-H09	16	16	100	20	16	17	SN□□0903□□	LV3	VHX0617	SS32	SP3	HW25L	LSPS3
	2020-K09	20	20	125	25	20	20	SN□□1204□□	LV4	VHX0821	SS42	SP4	HW30L	LSPS4
	2020-K12	20	20	125	25	20	23							
	2525-M12	25	25	150	32	25	23							
	3232-P12	32	32	170	40	32	23							
	2525-M15	25	25	150	32	25	28	SN□□1506□□	LV5	VHX0825	SS53	SP5	HW30L	LSPS5
	3232-P15	32	32	170	40	32	28	SN□□1906□□	LV6N	VHX1027N	SS63N	SP6N	HW40L	LSPS6
	3232-P19	32	32	170	40	32	41.5							
	4040-S19	40	40	250	50	40	41.5							
	4040-S25	40	40	250	50	40	46							
	4040-S25-6	40	40	250	50	40	46	SN□□2509□□	LV8N	VHX1236N	SS84N	SP8N	HW50L	LSPS8
	5050-T25-6	50	50	300	60	50	37.5	SN□□2509□□						

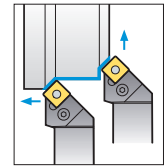
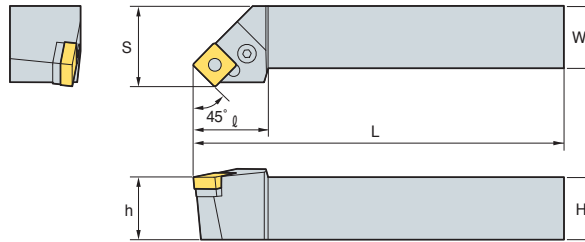
↻ Applicable inserts B50~B57



PSSNR/L



SN□□



45°

• R type insert (mm)

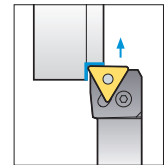
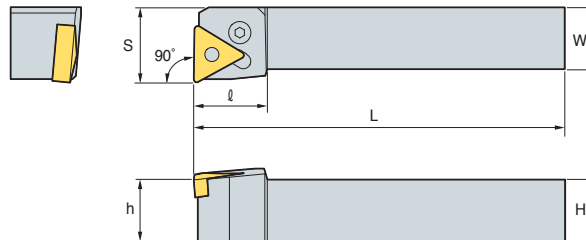
Designation	H	W	L	S	h	ℓ	Insert	Lever	Screw	Shim	Shim Pin	Wrench	Shim Pin Punch	
PSSNR/L	1616-H09	16	16	100	20	16	25	SN□□0903□□	LV3	VHX0617	SS32	SP3	HW25L	LSPS3
	2020-K12	20	20	125	25	20	30	SN□□1204□□	LV4	VHX0821	SS42	SP4	HW30L	LSPS4
	2525-M12	25	25	150	32	25	36							
	3225-P12	32	25	170	32	32	36	SN□□1506□□	LV5	VHX0825	SS53	SP5	HW30L	LSPS5
	3232-P12	32	32	170	40	32	40							
	2525-M15	25	25	150	32	25	36	SN□□1906□□	LV6N	VHX1027N	SS63N	SP6N	HW40L	LSPS6
	3232-P15	32	32	170	40	32	45							
	3232-P19	32	32	170	40	32	41.5	SN□□2507□□	LV8N	VHX1236N	SS84N	SP8N	HW50L	LSPS8
	4040-R19	40	40	200	50	40	41.5							
	4040-S19	40	40	250	50	40	41.5	SN□□2509□□	LV8N	VHX1236N	SS84N	SP8N	HW50L	LSPS8
4040-S25	40	40	250	50	40	48								
4040-S25-6	40	40	250	50	40	48	SN□□2509□□	LV8N	VHX1236N	SS84N	SP8N	HW50L	LSPS8	

➔ Applicable inserts B50~B57

PTFNR/L



TN□□



90°

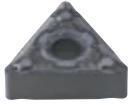
• R type insert (mm)

Designation	H	W	L	S	h	ℓ	Insert	Lever	Screw	Shim	Shim Pin	Wrench	Shim Pin Punch	
PTFNR/L	1616-H16	16	16	100	20	16	20	TN□□1604□□	LV3	VHX0617	ST317	SP3	HW25L	LSPS3
	2020-K16	20	20	125	25	20	20							
	2525-M16	25	25	150	32	25	20							
	2525-M22	25	25	150	32	25	25	TN□□2204□□	LV4	VHX0821	ST42	SP4	HW30L	LSPS4
	3232-P22	32	32	170	40	32	25							
	3232-P27	32	32	170	40	32	34	TN□□2706□□	LV5	VHX0825	ST53	SP5	HW30L	LSPS5
	4040-S27	40	40	250	50	40	34							

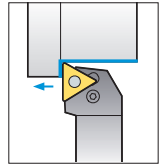
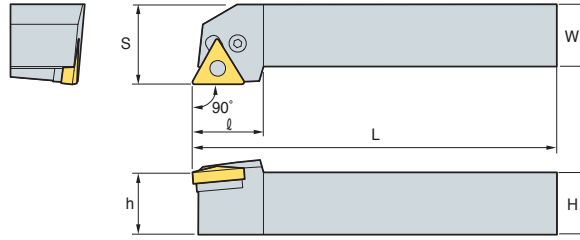
➔ Applicable inserts B58~B65

B Lever Lock System

PTGNR/L



TN□□



90°

• R type insert (mm)

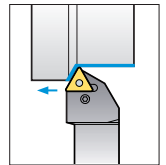
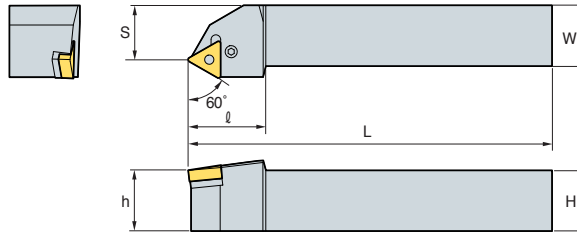
Designation	H	W	L	S	h	l	Insert	Lever	Screw	Shim	Shim Pin	Wrench	Shim Pin Punch
PTGNR/L 1212-F11	12	12	80	16	12	16	TN□□1103□□	LV2	VHX0509B	-	-	HW20L	-
1616-H11	16	16	100	20	16	18							
2020-K11	20	20	125	25	20	19							
2525-M11	25	25	150	32	25	20							
1616-H16	16	16	100	20	16	20	TN□□1604□□	LV3	VHX0617	ST317	SP3	HW25L	LSPS3
2020-K16	20	20	125	25	20	20							
2525-M16	25	25	150	32	25	20							
3232-P16	32	32	170	40	32	20							
2525-M22	25	25	150	32	25	28	TN□□2204□□	LV4	VHX0821	ST42	SP4	HW30L	LSPS4
3232-P22	32	32	170	40	32	28							
3232-P27	32	32	170	40	32	33	TN□□2706□□	LV5	VHX0825	ST53	SP5	HW30L	LSPS5
4040-S27	40	40	250	50	40	33							

↻ Applicable inserts B58~B65

PTTNR/L



TN□□



60°

• R type insert (mm)

Designation	H	W	L	S	h	l	Insert	Lever	Screw	Shim	Shim Pin	Wrench	Shim Pin Punch
PTTNR/L 1616-H16	16	16	100	13	16	25	TN□□1604□□	LV3	VHX0617	ST317	SP3	HW25L	LSPS3
2020-K16	20	20	125	17	20	25							
2525-M16	25	25	150	22	25	32							
2525-M22	25	25	150	22	25	32	TN□□2204□□	LV4	VHX0821	ST42	SP4	HW30L	LSPS4

↻ Applicable inserts B58~B65

PWLNR/L



WN□□

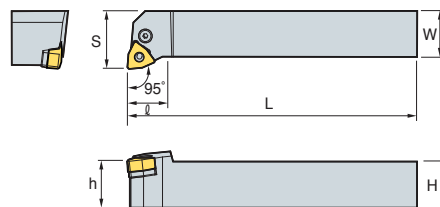


Fig. 1

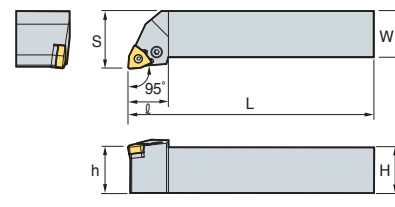
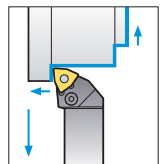


Fig. 2



95°

• R type insert (mm)

Designation	H	W	L	S	h	l	Insert	Lever	Screw	Shim	Shim Pin	Wrench	Shim Pin Punch	Fig.
PWLNR/L 1616-H06	16	16	100	20	16	20	WN□□0604□□	LV3	VHX0617	SW317	SP3	HW25L	LSPS3	1
2020-K06	20	20	125	25	20	20								
2525-M06	25	25	150	32	25	20								
2020-K08	20	20	125	25	20	26	WN□□0804□□	LV4	VHX0821	SW42	SP4	HW30L	LSPS4	2
2525-M08	25	25	150	32	25	26								

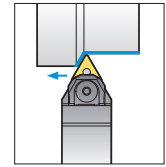
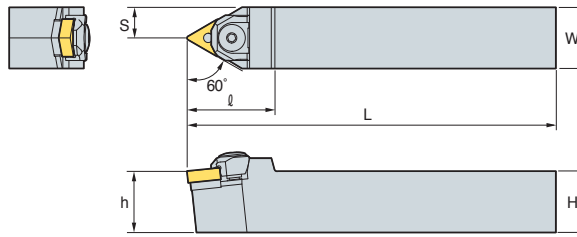
↻ Applicable inserts B68~B72



WTENN



TN□□



60°

• R type insert (mm)

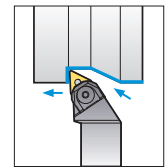
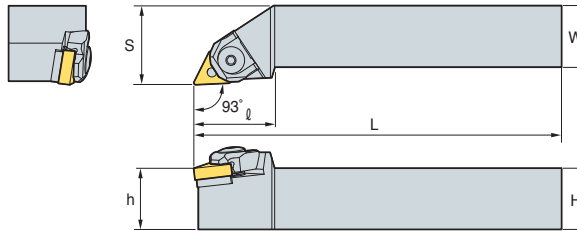
Designation	H	W	L	S	h	ℓ	Insert	Wedge Clamp	Screw	Stopper Ring	Shim	Shim Pin	Nut	Wrench
WTENN 2020-K16	20	20	125	10	20	36	TN□□1604□□							
	25	25	150	12.5	25	36								
	25	25	150	12.5	25	42								
3232-P22	32	32	170	16	32	42	TN□□2204□□							

↻ Applicable inserts B58~B65

WTJNR/L



TN□□



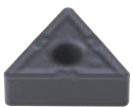
93°

• R type insert (mm)

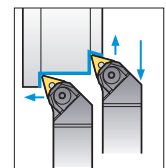
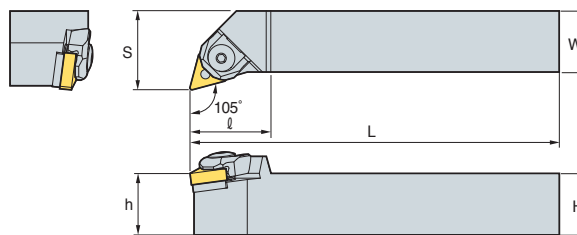
Designation	H	W	L	S	h	ℓ	Insert	Wedge Clamp	Screw	Stopper Ring	Shim	Shim Pin	Nut	Wrench
WTJNR/L 2020-K16	20	20	125	25	20	33	TN□□1604□□							
	25	25	150	32	25	33								
	32	32	170	40	32	33								
2525-M22	25	25	150	32	25	35	TN□□2204□□							
3232-P16	32	32	170	40	32	33								
3232-P22	32	32	170	40	32	35	TN□□2204□□							

↻ Applicable inserts B58~B65

WTXNR/L



TN□□



105°

• R type insert (mm)

Designation	H	W	L	S	h	ℓ	Insert	Wedge Clamp	Screw	Stopper Ring	Shim	Shim Pin	Nut	Wrench
WTXNR/L 2020-K16	20	20	125	25	20	30	TN□□1604□□							
	25	25	150	32	25	33								
	32	32	170	40	32	33								
3232-P16	32	32	170	40	32	33	TN□□1604□□							

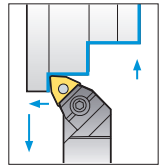
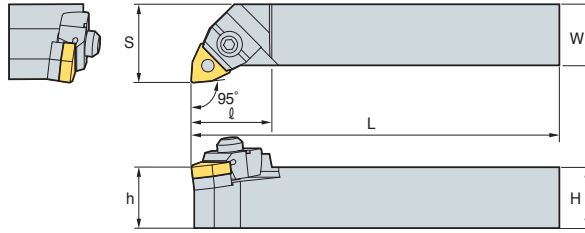
↻ Applicable inserts B58~B65

B Wedge Clamp System

WWLNR/L



WN□□



95°

• R type insert (mm)

Designation	H	W	L	S	h	ℓ	Insert	Wedge Clamp	Screw	Stopper Ring	Shim	Shim Pin	Nut	Wrench	
WWLNR/L	2020-K08	20	20	125	25	20	32	WN□□0804□□	CMH6R/L3				SP2M		
									CMH6R2	MHX0630	CR05	SW43M	SP4M	N0508	HW30L
									CMH6R2						HW40L

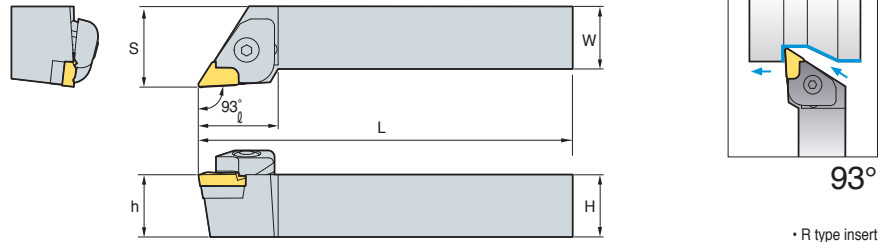
↻ Applicable inserts B68~B72



CKJNR/L



KN□□



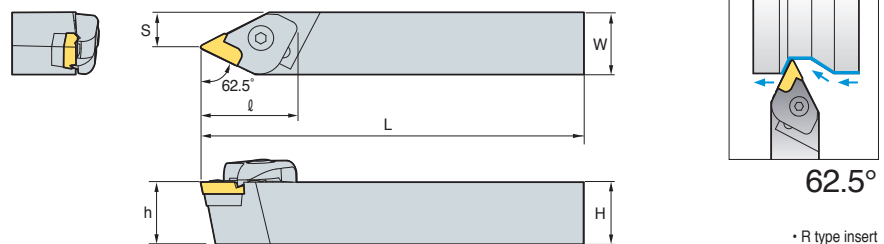
Designation		H	W	L	S	h	ℓ	Insert	Clamp	Clamp Screw	Spring	Shim	Pin + Spring	Shim Screw	Wrench
CKJNR	2020-K16	20	20	125	25	20	32	KN□□1604□□R							
	2525-M16	25	25	150	32	25	32								
	3225-M16	32	25	150	32	32	32								
	3225-P16	32	25	170	32	32	32								
	3232-P16	32	32	170	40	32	32								
4040-R16	40	40	200	50	40	32	CTH6R1	CHX0625	SR3	SK33C	PN0515 SR4	SHX0310	HW20L HW40L		
CKJNL	2020-K16	20	20	125	25	20	32	KN□□1604□□L							
	2525-M16	25	25	150	32	25	32								
	3232-P16	32	32	170	40	32	32								
	4040-R16	40	40	200	50	40	32								

➔ Applicable inserts B49

CKNNR/L



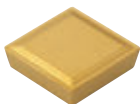
KN□□



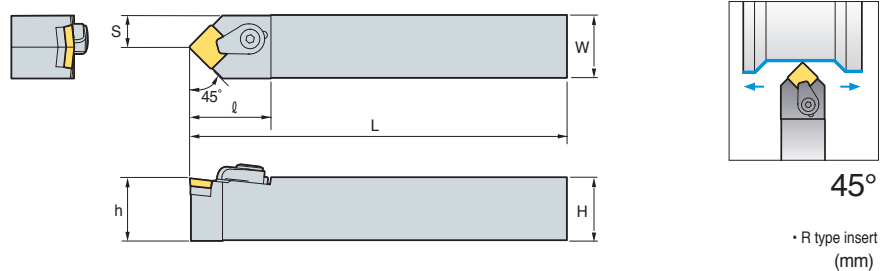
Designation		H	W	L	S	h	ℓ	Insert	Clamp	Clamp Screw	Spring	Shim	Pin + Spring	Shim Screw	Wrench
CKNNR	2525-M16	25	25	150	14.3	25	37	KN□□1604□□R							
	3232-P16	32	32	170	16.8	32	37								
CKNNL	2525-M16	25	25	150	14.3	25	37	KN□□1604□□L							
	3232-P16	32	32	170	16.8	32	37								

➔ Applicable inserts B49

CSDPN



SP□R



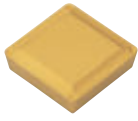
Designation		H	W	L	S	h	ℓ	Insert	Clamp	Clamp Screw	Shim	Shim Pin	C-Ring	Wrench
CSDPN	1616-H09	16	16	100	8	16	30	SP□R0903□□						
	2525-M12	25	25	150	12.5	25	35	SP□R1203□□	CH53R1	CH0515C	SS32C	SP3C	CR03C	HW25L
									CH6R5	CHX0622C	SS42C	SP3C	CR04C	HW30L

➔ Applicable inserts B85~B86

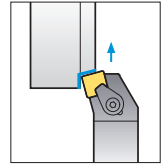
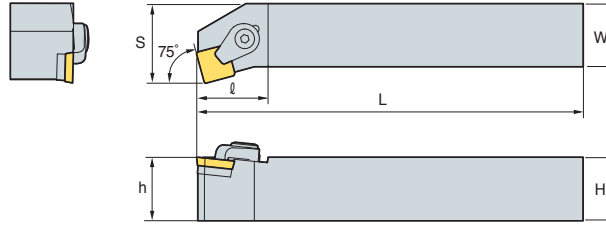


B Clamp on System

CSKPR/L



SP□R



75°

• R type insert (mm)

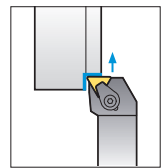
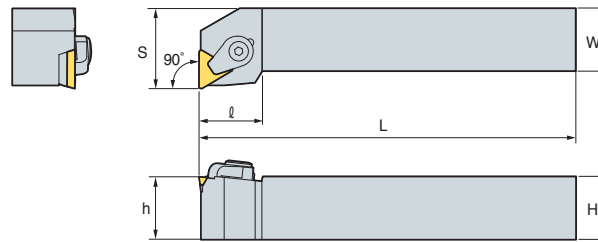
Designation	H	W	L	S	h	l	Insert	Clamp	Clamp Screw	Shim	Shim Pin	C-Ring	Wrench
CSKPR/L 2525-M12	25	25	150	32	20	32	SP□R1203□□	CH6R5	CHX0414C	SS42C	SP3C	CR04C	HW30L

➔ Applicable inserts B85~B86

CTFPR/L



TP□R



90°

• R type insert (mm)

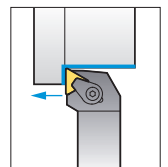
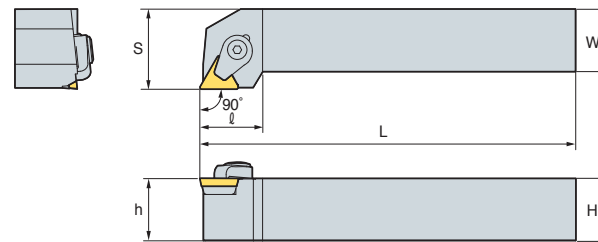
Designation	H	W	L	S	h	l	Insert	Clamp	Clamp Screw	Shim	Shim Pin	C-Ring	Wrench
CTFPR/L 2020-K16	25	25	125	25	20	32	TP□R1603□□	CH6R5	CHX0622C	ST32C	SP3C	CR04C	HW30L
2525-M16	25	25	150	32	25	32							

➔ Applicable inserts B90~B93

CTGPR/L



TP□R



90°

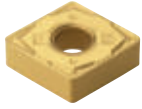
• R type insert (mm)

Designation	H	W	L	S	h	l	Insert	Clamp	Clamp Screw	Shim	Shim Pin	C-Ring	Wrench
CTGPR/L 1212-F11	12	12	80	16	12	20	TP□R1103□□	CH53R1	CHX0515C	-	-	CR03C	HW25L
1616-H11	16	16	100	20	16	20							
2020-K11	20	20	125	25	20	20							
2020-K16	20	20	125	25	20	25	TP□R1603□□	CH6R5	CHX0622C	ST32C	SP3C	CR04C	HW30L
2525-M16	25	25	150	32	25	25							
2525-M22	25	25	150	32	25	32	TP□R2204□□	CH83R1	CHX0823C	ST43C	SP4C	CR05C	HW40L
3232-P22	32	32	170	40	32	32							

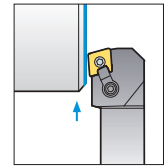
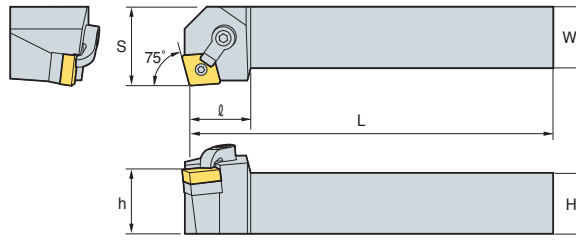
➔ Applicable inserts B90~B93



MCKNR/L



CN□□



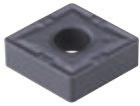
75°

• R type insert
(mm)

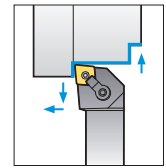
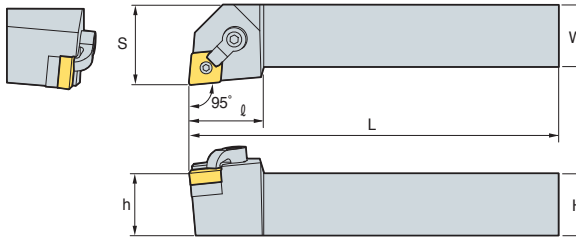
Designation	H	W	L	S	h	l	Insert	Clamp	Clamp Screw	Shim	Shim Pin	Wrench
MCKNR/L 2020-K12	20	20	125	25	20	32	CN□□1204□□					
2525-M12	25	25	150	32	25	32						
3232-P12	32	32	170	40	32	32						
								CDH6N	DHA1/4-25	SC43D	SP4D	HW31.8L HW23.8L

➔ Applicable inserts B36~B42

MCLNR/L



CN□□



95°

• R type insert
(mm)

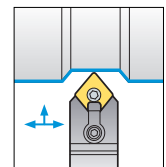
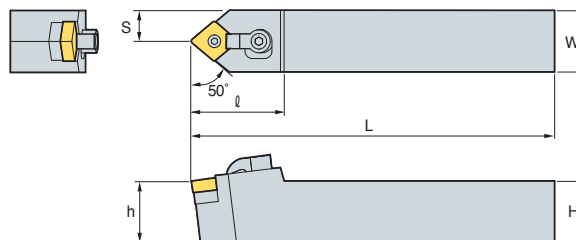
Designation	H	W	L	S	h	l	Insert	Clamp	Clamp Screw	Shim	Shim Pin	Wrench
MCLNR/L 1616-H09	16	16	100	20	16	25	CN□□0903□□					
2020-K09	20	20	125	25	20	25						
2525-M09	25	25	150	32	25	25						
2020-K12	20	20	125	25	20	32	CN□□1204□□					
2525-M12	25	25	150	32	25	32						
3225-P12	32	25	170	32	32	32						
3232-P12	32	32	170	40	32	32	CN□□1606□□					
2525-M16	25	25	150	32	25	33						
3232-P16	32	32	170	40	32	33						
4040-S16	40	40	250	50	40	33	CN□□1906□□					
2525-M19	25	25	150	32	25	38						
3232-P19	32	32	170	40	32	38						
4040-S19	40	40	250	50	40	38	CN□□2507□□					
4040-S25	40	40	250	50	40	38						
								CDH7N	DHA10-32-19	SC32D	SP3DS	HW23.8L HW19.8L
								CDH6N	DHA1/4-25	SC43D	SP4D	HW31.8L HW23.8L
								CDH8N	DHA5/16-32	SC53D	SP5D	HW39.7L HW31.8L
								CDH8N	DHA5/16-32	SC63D	SP6D	HW39.7L HW35.7L
								CDH8N3	DHA3/8-35	SC84D	SP8D	HW39.7L HW47.6L

➔ Applicable inserts B36~B42

MCMNN



CN□□



50°

• R type insert
(mm)

Designation	H	W	L	S	h	l	Insert	Clamp	Clamp Screw	Shim	Shim Pin	Wrench
MCMNN 2020-K12	20	20	125	10	20	32	CN□□1204□□					
2525-M12	25	25	150	12.5	25	32						
3232-P12	32	32	170	16	32	32						
2525-M16	25	25	150	12.5	25	40	CN□□1606□□					
3232-P16	32	32	170	16	32	40						
3232-P19	32	32	170	16	32	40						
4040-S19	40	40	250	20	40	32	CN□□1906□□					
								CDH6N	DHA1/4-25	SC43D	SP4D	HW31.8L HW23.8L
								CDH8N	DHA5/16-32	SC53D	SP5D	HW39.7L HW31.8L
								CDH8N	DHA5/16-32	SD63D	SP6D	HW39.7L HW35.7L

➔ Applicable inserts B36~B42

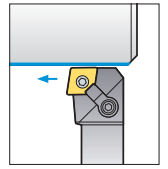
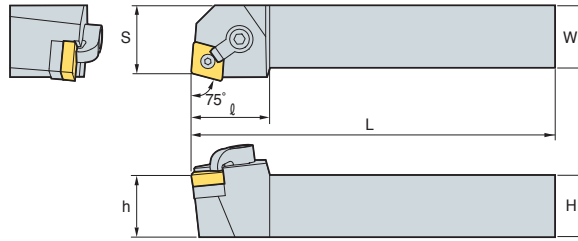


B Multi Lock System

MCRNR/L



CN□□



75°

• R type insert (mm)

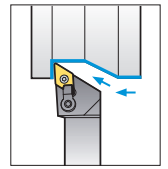
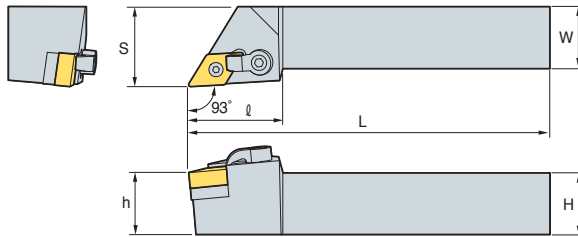
Designation	H	W	L	S	h	ℓ	Insert	Clamp	Clamp Screw	Shim	Shim Pin	Wrench						
MCRNR/L 2020-K12	20	20	125	22	20	32	CN□□1204□□											
	2525-M12	25	25	150	27	25							32	CDH8N1	DHA5/16-32	SC43D	SP4D	HW39.7L HW23.8L
	2525-M16	25	25	150	27	25							33	CDH8N1	DHA5/16-32	SC53D	SP5D	HW39.7L HW31.8L
3232-P16	32	32	170	35	32	33	CN□□1906□□	CDH8N1	DHA5/16-32	SC63D	SP6D	HW39.7L HW35.7L						
3232-P19	32	32	170	35	32	38												
4040-S19	40	40	250	43	40	38												

➔ Applicable inserts B36~B42

MDJNR/L



DN□□



93°

• R type insert (mm)

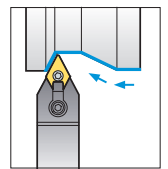
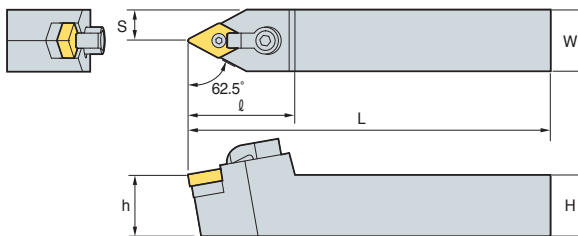
Designation	H	W	L	S	h	ℓ	Insert	Clamp	Clamp Screw	Shim	Shim Pin	Wrench
MDJNR/L 2020-K11	20	20	125	25	20	32	DN□□1104□□					
	2525-M11	25	25	150	32	25						
2020-K15-3	20	20	125	25	20	36	DN□□1504□□	CDH6N	DHA1/4-25	SD43D	SP4D	HW31.8L HW23.8L
2525-M15-3	25	25	150	32	25	36						
3232-P15-3	32	32	170	40	32	36	DN□□1506□□	CDH6N	DHA1/4-25	SD43D	SP4DL	HW31.8L HW23.8L
2020-K15	20	20	125	25	20	36						
2525-M15	25	25	150	32	25	36						
3232-P15	32	32	170	40	32	36						

➔ Applicable inserts B43~B48

MDNNN



DN□□



62.5°

(mm)

Designation	H	W	L	S	h	ℓ	Insert	Clamp	Clamp Screw	Shim	Shim Pin	Wrench
MDNNN 2525-M15-3	25	25	150	12.5	25	41	DN□□1504□□					
	2525-M15	25	25	150	12.5	25						
	25	25	150	12.5	25	41	DN□□1506□□	CDH8N	DHA5/16-32	SD43D	SP4DL	HW39.7L HW23.8L

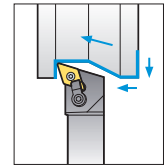
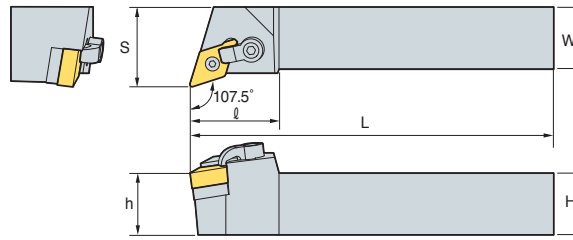
➔ Applicable inserts B43~B48



MDQNR/L



DN□□



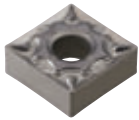
107.5°

• R type insert (mm)

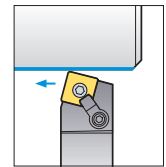
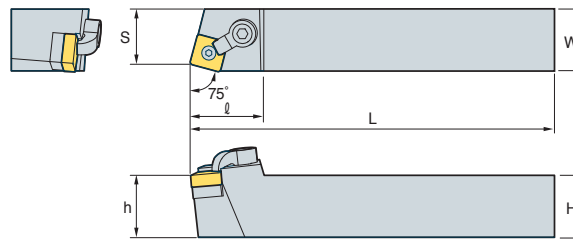
Designation	H	W	L	S	h	ℓ	Insert	Clamp	Clamp Screw	Shim	Shim Pin	Wrench
MDQNR/L 2525-M15-3	25	25	150	32	25	36	DN□□1504□□	CDH6N	DHA1/4-25	SD43D	SP4D	HW31.8L HW23.8L
3232-P15-3	32	32	170	40	32	36						
2525-M15	25	25	150	32	25	36	DN□□1506□□	CDH6N	DHA1/4-25	SD43D	SP4DL	HW31.8L HW23.8L
3232-M15	32	32	170	40	32	36						

➔ Applicable inserts B43~B48

MSBNR/L



SN□□



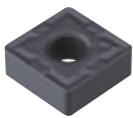
75°

• R type insert (mm)

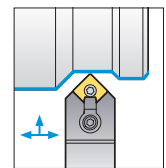
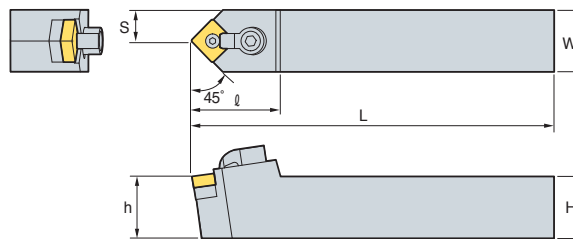
Designation	H	W	L	S	h	ℓ	Insert	Clamp	Clamp Screw	Shim	Shim Pin	Wrench
MSBNR/L 2020-K12	20	20	125	17	20	32	SN□□1204□□	CDH8N1	DHA5/16-32	SS43D	SP4D	HW39.7L HW23.8L
2525-M12	25	25	150	22	25	32						
2525-M15	25	25	150	22	25	35	SN□□1506□□	CDH8N	DHA5/16-32	SS53D	SP5D	HW39.7L HW31.8L
3232-P15	32	32	170	22	32	35						
3232-P19	32	32	170	27	32	40	SN□□1906□□	CDH8N	DHA5/16-32	SS63D	SP6D	HW39.7L HW35.7L
4040-S19	40	40	250	35	40	40						

➔ Applicable inserts B50~B57

MSDNN



SN□□



45°

(mm)

Designation	H	W	L	S	h	ℓ	Insert	Clamp	Clamp Screw	Shim	Shim Pin	Wrench
MSDNN 1616-H09	16	16	100	8	16	28	SN□□0903□□	CDH7N	DHA10-32-19	SS32D	SP3DS	HW19.8L HW23.8L
2020-K09	20	20	125	10	20	28						
2020-K12	20	20	125	10	20	32						
2525-M12	25	25	150	12.5	25	32	SN□□1204□□	CDH8N1	DHA5/16-32	SS43D	SP4D	HW39.7L HW23.8L
3225-P12	32	25	170	12.5	32	32						
2525-M15	25	25	150	12.5	25	35	SN□□1506□□	CDH8N	DHA5/16-32	SS53D	SP5D	HW39.7L HW31.8L
3225-P15	32	25	170	12.5	32	35						
3232-P15	32	32	170	16	32	35						
4040-S15	40	40	250	20	40	35						
3232-P19	32	32	170	16	32	42	SN□□1906□□	CDH8N	DHA5/16-32	SS63D	SP6D	HW39.7L HW35.7L
4040-S19	40	40	250	20	40	42						

➔ Applicable inserts B50~B57

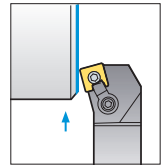
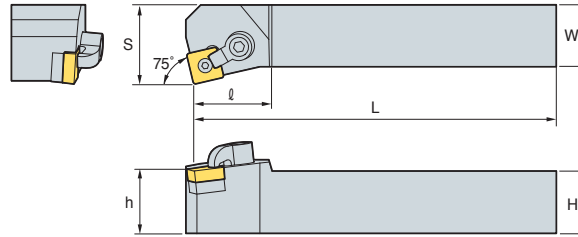


B Multi Lock System

MSKNR/L



SN□□



75°

• R type insert (mm)

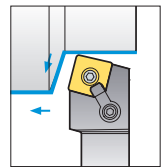
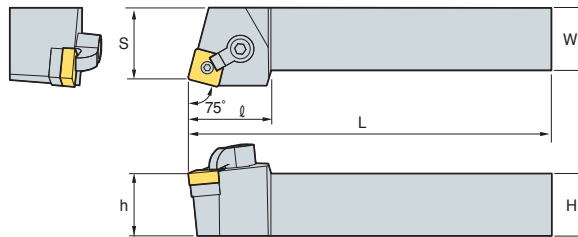
Designation	H	W	L	S	h	l	Insert	Clamp	Clamp Screw	Shim	Shim Pin	Wrench
MSKNR/L 1616-H09	16	16	100	20	16	28	SN□□0903□□	CDH7N	DHA10-32-19	SS32D	SP3DS	HW19.8L HW23.8L
	20	20	125	22	20	28						
	20	20	125	25	20	32						
2525-M12	25	25	150	32	25	32	SN□□1204□□	CDH8N1	DHA5/16-32	SS43D	SP4D	HW39.7L HW23.8L
3225-P12	32	25	170	32	32	32						
2525-M15	25	25	150	32	25	35	SN□□1506□□	CDH8N	DHA5/16-32	SS53D	SP5D	HW39.7L HW31.8L
3232-P15	32	32	170	40	32	35						
3232-P19	32	32	170	40	32	40	SN□□1906□□	CDH8N	DHA5/16-32	SS63D	SP6D	HW39.7L HW35.7L
4040-S19	40	40	250	50	40	40						
4040-S25	40	40	250	50	40	40	SN□□2507□□	CDH8N3	DHA3/8-35	SS84D	SP8D	HW47.6L HW39.7L

↻ Applicable inserts B50~B57

MSRNR/L



SN□□



75°

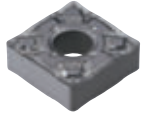
• R type insert (mm)

Designation	H	W	L	S	h	l	Insert	Clamp	Clamp Screw	Shim	Shim Pin	Wrench
MSRNR/L 1616-H09	16	16	100	17	16	28	SN□□0903□□	CDH7N	DHA10-32-19	SS32D	SP3DS	HW19.8L HW23.8L
	20	20	125	22	20	28						
	20	20	125	22	20	32						
2525-M12	25	25	150	27	25	32	SN□□1204□□	CDH8N1	DHA5/16-32	SS43D	SP4D	HW39.7L HW23.8L
3225-P15	32	32	170	35	32	35						
2525-M15	25	25	150	27	25	35	SN□□1506□□	CDH8N	DHA5/16-32	SS53D	SP5D	HW39.7L HW31.8L
3232-P15	32	32	170	35	32	40						
3232-P19	32	32	170	35	32	40	SN□□1906□□	CDH8N	DHA5/16-32	SS63D	SP6D	HW39.7L HW35.7L
4040-S19	40	40	250	43	40	40						
4040-S25	40	40	250	43	40	40	SN□□2507□□	CDH8N3	DHA3/8-35	SS84D	SP8D	HW47.6L HW39.7L

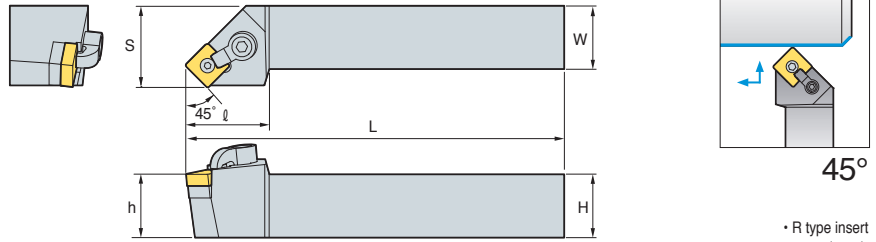
↻ Applicable inserts B50~B57



MSSNR/L



SN□□



45°
• R type insert (mm)

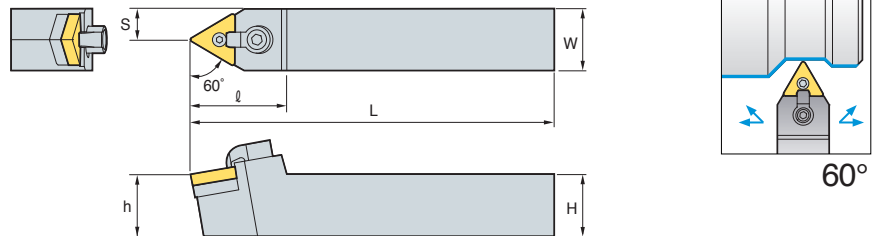
Designation	H	W	L	S	h	l	Insert	Clamp	Clamp Screw	Shim	Shim Pin	Wrench
MSSNR/L 1616-H09	16	16	100	20	16	28	SN□□0903□□	CDH7N	DHA10-32-19	SS32D	SP3DS	HW19.8L HW23.8L
	20	20	125	25	20	28						
2020-K12	20	20	125	25	20	32	SN□□1204□□	CDH8N1	DHA5/16-32	SS43D	SP4D	HW39.7L HW23.8L
2525-M12	25	25	150	32	25	32						
2525-M15	25	25	150	32	25	35	SN□□1506□□	CDH8N1	DHA5/16-32	SS53D	SP5D	HW39.7L HW31.8L
3232-P15	32	32	170	40	32	35						
3232-P19	32	32	170	40	32	40	SN□□1906□□	CDH8N1	DHA5/16-32	SS63D	SP6D	HW39.7L HW35.7L
4040-S19	40	40	250	50	40	40						

↻ Applicable inserts B50~B57

MTENN



TN□□



60°
(mm)

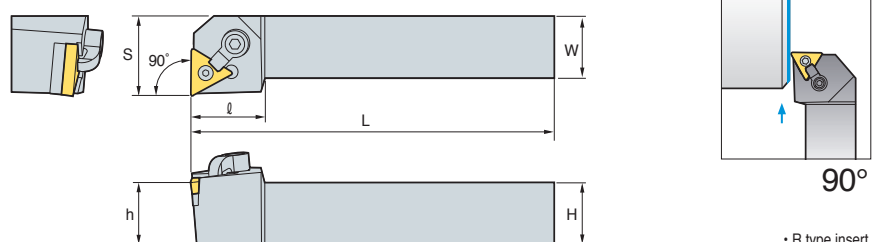
Designation	H	W	L	S	h	l	Insert	Clamp	Clamp Screw	Shim	Shim Pin	Wrench
MTENN 2020-K16	20	20	125	10	20	32	TN□□1604□□	CDH7N	DHA10-32-19	ST32D	SP3D	HW23.8L HW19.8L
	25	25	150	12.5	25	32						
2525-M22	25	25	150	12.5	25	35	TN□□2204□□	CDH8N1	DHA5/16-32	ST43D	SP4D	HW39.7L HW23.8L
3232-P27	32	32	170	16	32	35	TN□□2706□□	CDH8N1	DHA5/16-32	ST53D	SP5D	HW39.7L HW31.8L
4040-S33	40	40	250	20	40	40	TN□□3307□□	CDH8N	DHA5/16-32	ST63D	SP6DL	HW39.7L HW35.7L

↻ Applicable inserts B58~B65

MTFNR/L



TN□□



90°
• R type insert (mm)

Designation	H	W	L	S	h	l	Insert	Clamp	Clamp Screw	Shim	Shim Pin	Wrench
MTFNR/L 1616-H16	16	16	100	20	16	32	TN□□1604□□	CDH7N	DHA10-32-19	ST32D	SP3D	HW23.8L HW19.8L
	20	20	125	25	20	32						
2525-M16	25	25	150	32	25	32	TN□□2204□□	CDH8N1	DHA5/16-32	ST43D	SP4D	HW39.7L HW23.8L
2525-M22	25	25	150	32	25	32						
3232-P22	32	32	170	40	32	32	TN□□2706□□	CDH8N1	DHA5/16-32	ST53D	SP5D	HW39.7L HW31.8L
4040-S22	40	40	250	50	40	32						
3232-P27	32	32	170	40	32	35	TN□□2706□□	CDH8N1	DHA5/16-32	ST53D	SP5D	HW39.7L HW31.8L
4040-S27	40	40	250	50	40	35						
4040-S33	40	40	250	50	40	40	TN□□3307□□	CDH8N	DHA5/16-32	ST63D	SP6DL	HW39.7L HW35.7L

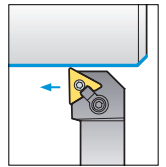
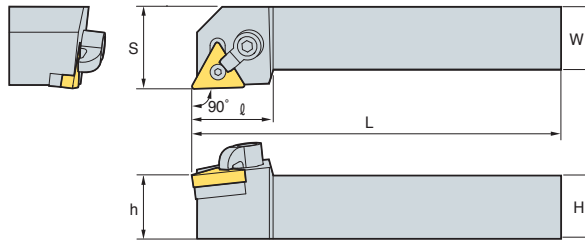
↻ Applicable inserts B58~B65



MTGNR/L



TN□□



90°

• R type insert (mm)

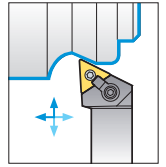
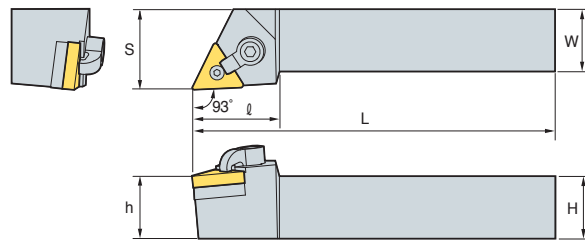
Designation	H	W	L	S	h	ℓ	Insert	Clamp	Clamp Screw	Shim	Shim Pin	Wrench
MTGNR/L 1616-H16	16	16	100	20	16	32	TN□□1604□□	CDH7N	DHA10-32-19	ST32D	SP3D	HW23.8L HW19.8L
2020-K16	20	20	125	25	20	32						
2525-M16	25	25	150	32	25	32						
2525-M22	25	25	150	32	25	32	TN□□2204□□	CDH8N1	DHA5/16-32	ST43D	SP4D	HW39.7L HW23.8L
3232-P22	32	32	170	40	32	32	TN□□2706□□	CDH8N1	DHA5/16-32	ST53D	SP5D	HW39.7L HW31.8L
3232-P27	32	32	170	40	32	35						
4040-S27	40	40	250	50	40	35	TN□□3307□□	CDH8N	DHA5/16-32	ST63D	SP6DL	HW39.7L HW35.7L
4040-S33	40	40	250	50	40	40						

↻ Applicable inserts B58~B65

MTJNR/L



TN□□



93°

• R type insert (mm)

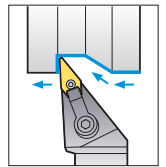
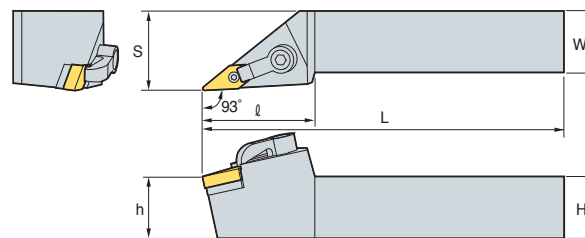
Designation	H	W	L	S	h	ℓ	Insert	Clamp	Clamp Screw	Shim	Shim Pin	Wrench
MTJNR/L 2020-K16	20	20	125	25	20	32	TN□□1604□□	CDH7N	DHA10-32-19	ST32D	SP3D	HW23.8L HW19.8L
2525-M16	25	25	150	32	25	32						
2525-M22	25	25	150	32	25	32						
3232-P22	32	32	170	40	32	32	TN□□2204□□	CDH8N1	DHA5/16-32	ST43D	SP4D	HW39.7L HW23.8L
3232-P27	32	32	170	40	32	35	TN□□2706□□	CDH8N1	DHA5/16-32	ST53D	SP5D	HW39.7L HW31.8L
4040-S27	40	40	250	50	40	35						
4040-S33	40	40	250	50	40	40	TN□□3307□□	CDH8N	DHA5/16-32	ST63D	SP6DL	HW39.7L HW35.7L

↻ Applicable inserts B58~B65

MVJNR/L



VN□□



93°

• R type insert (mm)

Designation	H	W	L	S	h	ℓ	Insert	Clamp	Clamp Screw	Shim	Shim Pin	Wrench
MVJNR/L 2020-K16	20	20	125	25	20	44	VN□□1604□□	CDH8N2	DHA5/16-32	SV32D	SP3D	HW39.7L HW19.8L
2525-M16	25	25	150	32	25	45.5						
3232-P16	32	32	170	40	32	55.5						
2525-M22	25	25	150	32	25	56	VN□□2204□□	CDH8N2	DHA5/16-32	SV43D	SP4D	HW39.7L HW23.8L
3232-P22	32	32	170	40	32	55						
4040-S22	40	40	250	50	40	65						

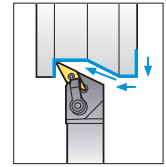
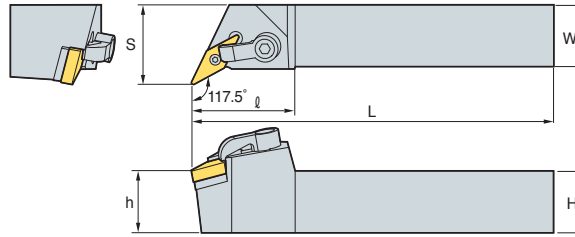
↻ Applicable inserts B66~B67



MVQNR/L



VN□□



117.5°

· R type insert (mm)

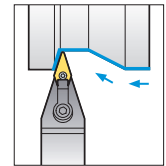
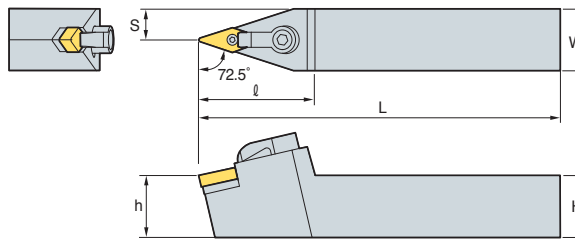
Designation	H	W	L	S	h	ℓ	Insert	Clamp	Clamp Screw	Shim	Shim Pin	Wrench
MVQNR/L 2020-K16	20	20	125	25	20	42	VN□□1604□□					
2525-M16	25	25	150	32	25	42						
3232-P16	32	32	170	40	32	37						

↻ Applicable inserts B66~B67

MVVNN



VN□□



72.5°

(mm)

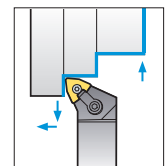
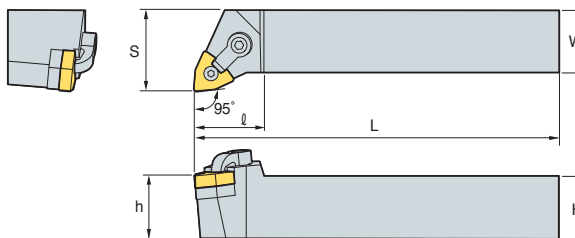
Designation	H	W	L	S	h	ℓ	Insert	Clamp	Clamp Screw	Shim	Shim Pin	Wrench
MVVNN 2020-K16	20	20	125	25	20	42	VN□□1604□□					
2525-M16	25	25	150	32	25	42						

↻ Applicable inserts B66~B67

MWLNR/L



WN□□



95°

· R type insert (mm)

Designation	H	W	L	S	h	ℓ	Insert	Clamp	Clamp Screw	Shim	Shim Pin	Wrench
MWLNR/L 2020-K06	20	20	125	25	20	32	WN□□0604□□					
2525-M06	25	25	150	32	25	32						
3232-P06	32	32	170	40	32	32						
2020-K08	20	20	125	25	20	32	WN□□0804□□					
2525-M08	25	25	150	32	25	32						
3232-P08	32	32	170	40	32	32						

↻ Applicable inserts B68~B72

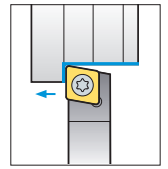
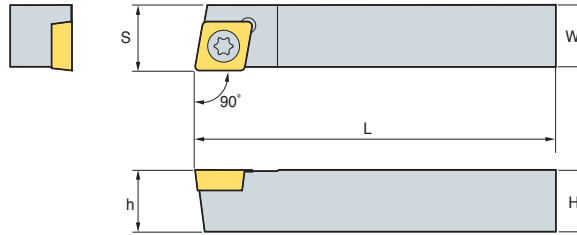


B Screw on System

SCACR/L



CC□T



90°

• R type insert (mm)

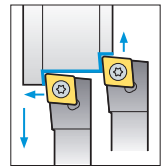
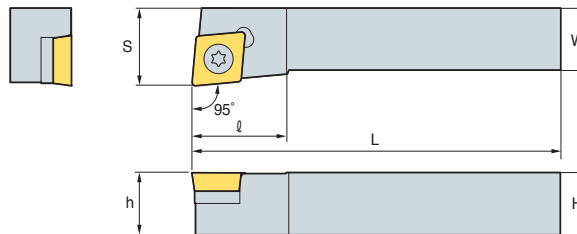
Designation	H	W	L	S	h	Insert	Screw	Shim	Shim Screw	Wrench
SCACR/L 1010-E06	10	10	70	10.5	10	CC□□T0602□□	FTKA02565	-	-	TW07P
1212-F09	12	12	80	12.5	12	CC□□T09T3□□	FTKA03508	-	-	TW15P

↻ Applicable inserts B73~B77, B103

SCLCR/L



CC□T



95°

• R type insert (mm)

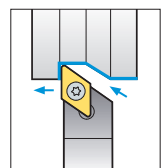
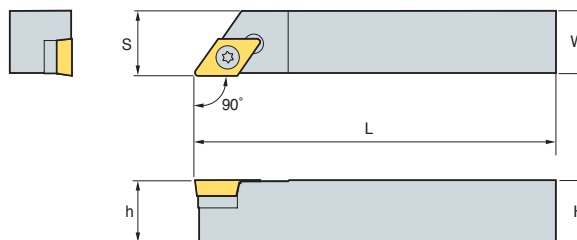
Designation	H	W	L	S	h	ℓ	Insert	Screw	Shim	Shim Screw	Wrench					
SCLCR/L 0808-D06	08	08	60	10	08	10	CC□T0602□□	FTKA02565	-	-	TW07P					
1010-E06	10	10	70	16	10	10										
1212-F09	12	12	80	20	12	16										
1616-H09	16	16	100	20	16	16	CC□T09T3□□	FTGA03508	-	-	TW15P					
2020-K09	20	20	125	25	20	16	CC□T09T3□□	FTGA0411F	SC42S	SHXN0610F	TW15P, HW40L					
2525-M09	25	25	150	32	25	26										
2020-K12	20	20	125	25	20	25						CC□T1204□□	FTGA03508	-	-	TW15P
2525-M12	25	25	150	32	25	26						CC□T1204□□	FTGA0411F	SC42S	SHXN0610F	TW15P, HW40L

↻ Applicable inserts B73~B77, B103

SDACR/L



DC□T



90°

• R type insert (mm)

Designation	H	W	L	S	h	Insert	Screw	Shim	Shim Screw	Wrench
SDACR/L 1010-E07	10	10	70	10.5	10	DC□T0702□□	FTKA02565	-	-	TW07P
1212-F11	12	12	80	12.5	12	DC□T11T3□□	FTKA03508	-	-	TW15P
1616-H11	16	16	100	16.5	16		FTGA03512	SD32S	SHXN0509F	TW15P, HW35L

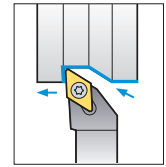
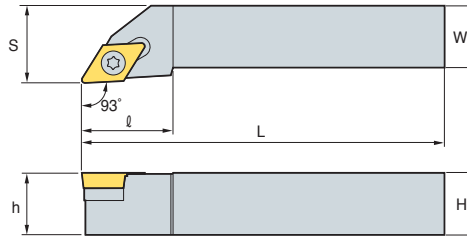
↻ Applicable inserts B79~B82, B104



SDJCR/L



DC□T



93°

• R type insert
(mm)

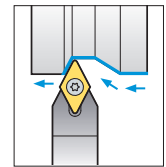
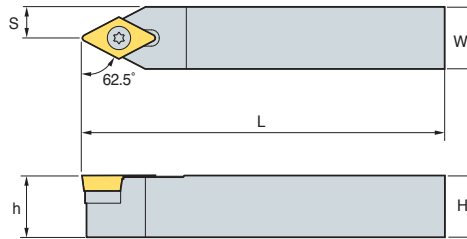
Designation	H	W	L	S	h	ℓ	Insert	Screw	Shim	Shim Screw	Wrench
SDJCR/L	1010-E07	10	10	70	12	10	DC□T0702□□	FTKA02565	-	-	TW07P
	1212-F07	12	12	80	16	12					
	1616-H07	16	16	100	20	16					
	2020-K07	20	20	125	25	20					
SDJCR/L	1212-F11	12	12	80	16	12	DC□T11T3□□	FTGA03512	SD32S	SHXN0509F	TW15P, HW35L
	1616-H11	16	16	100	20	16					
	2020-K11	20	20	125	25	20					
	2525-M11	25	25	150	32	25					

⇒ Applicable inserts B79~B82, B104

SDNCN



DC□T



62.5°

(mm)

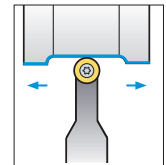
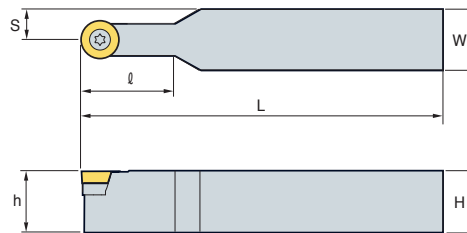
Designation	H	W	L	S	h	Insert	Screw	Shim	Shim Screw	Wrench	
SDNCN	1010-E07	10	10	70	5	10	DC□T0702□□	FTKA02565	-	-	TW07P
	1212-F07	12	12	80	6	12					
	1212-H11	12	12	100	6	12	DC□T11T3□□	FTGA03508	-	-	TW15P
	1616-H11	16	16	100	8	16	DC□T11T3□□	FTGA03512	SD32S	SHXN0509F	TW15P, HW35L
	2020-K11	20	20	125	10	20					
2025-M11	25	25	150	12.5	25	DC□T11T3□□	FTGA03512	SD32S	SHXN0509F	TW25P, HW35L	

⇒ Applicable inserts B79~B82, B104

SRDCN



RC□T



(mm)

Designation	H	W	L	S	h	ℓ	Insert	Screw	Shim	Shim Screw	Wrench
SRDCN	1010-E06	10	10	70	5	10	RC□T0602M0	FTKA02565	-	-	TW07P
	1212-F06	12	12	80	6	12					
	1616-H06	16	16	100	8	16					
SRDCN	2525-M06	25	25	150	12.5	25	RC□T0803M0	FTNA0307	-	-	TW09P
	1616-H08	16	16	100	8	16					
	2020-K08	20	20	125	10	20					
SRDCN	2525-M08	25	25	150	12.5	25	RC□T1003M0	FTKA03511A	SR10S	SHXN0509F	TW15P, HW35L
	1616-H10	16	16	100	8	16					
	2020-K10	20	20	125	10	20					
SRDCN	2525-M10	25	25	150	12.5	25	RC□T1204M0	FTGA03512	SR12S	SHXN0509F	TW15P, HW35L
	2020-K12	20	20	125	10	20					
	2525-M12	25	25	150	12.5	25					

⇒ Applicable inserts B83, B105

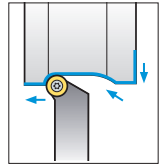
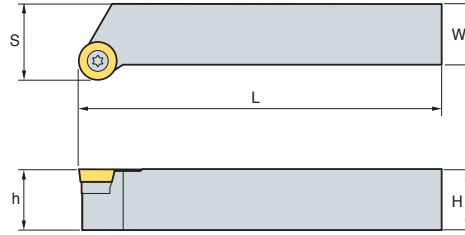


B Screw on System

SRGCR/L



RC□T

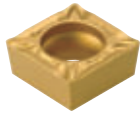


• R type insert
(mm)

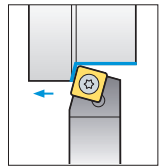
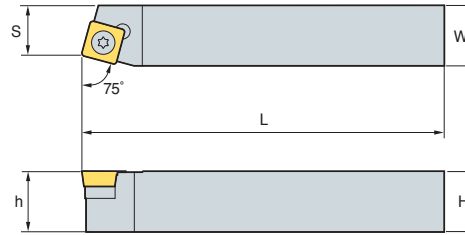
Designation	H	W	L	S	h	Insert	Screw	Shim	Shim Screw	Wrench
SRGCR/L	1010-E06	10	10	70	12	RC□T0602M0	FTKA02565	-	-	TW07P
	1212-F06	12	12	80	16					
	1616-H06	16	16	100	20					
SRGCR/L	1616-H08	16	16	100	20	RC□T0803M0	FTNA0307	-	-	TW09P
	2020-K08	20	20	125	25					
	2525-M08	25	25	150	32					
SRGCR/L	1616-H10	16	16	100	20	RC□T1003M0	FTKA03511A	SR10S	SHXN0509F	TW15P HW35L
	2020-K10	20	20	125	25					
	2525-M10	25	25	150	32					
SRGCR/L	2020-K12	20	20	125	25	RC□T1204M0	FTGA03512	SR12S	SHXN0509F	TW15P HW35L
	2525-M12	25	25	150	32					

➔ Applicable inserts B83, B105

SSBCR/L



SC□T



75°

• R type insert
(mm)

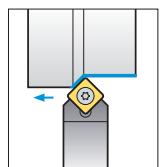
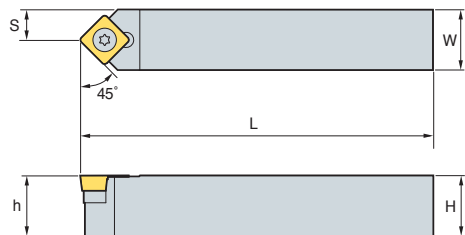
Designation	H	W	L	S	h	Insert	Screw	Shim	Shim Screw	Wrench
SSBCR/L	1212-F09	12	12	80	11	SC□T09T3□□	FTGA03508	-	-	TW15P
	1616-H09	16	16	100	13		FTGA03512	SS32S	SHXN0509F	TW15P, HW35L
	2020-K12	20	20	125	17	SC□T1204□□	FTGA0411F	SS42S	SHXN0610F	TW15P, HW40L

➔ Applicable inserts B84, B106

SSDCN



SC□T



45°

(mm)

Designation	H	W	L	S	h	Insert	Screw	Shim	Shim Screw	Wrench
SSDCN	1212-F09	12	12	80	6	SC□T09T3□□	FTGA03508	-	-	TW15P
	1616-H09	16	16	100	8		FTGA03512	SS32S	SHXN0509F	TW15P, HW35L

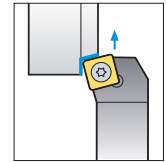
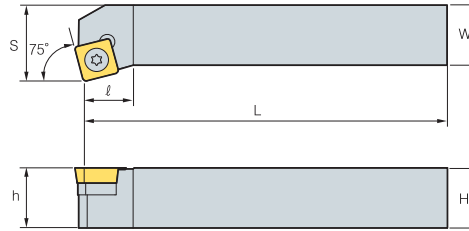
➔ Applicable inserts B84, B106



SSKCR/L



SC□T



75°

• R type insert (mm)

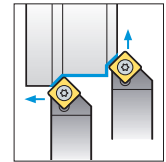
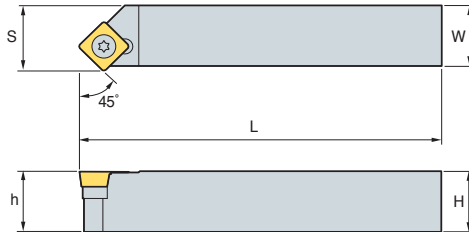
Designation	H	W	L	S	h	ℓ	Insert	Screw	Shim	Shim Screw	Wrench
SSKCR/L 1616-H09	16	16	100	20	16	13	SC□T09T3□□	FTGA03512	SS32S	SHXN0509F	TW15P, HW35L

↻ Applicable inserts **B84, B106**

SSSCR/L



SC□T



45°

• R type insert (mm)

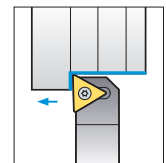
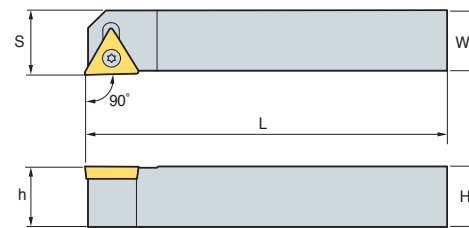
Designation	H	W	L	S	h	Insert	Screw	Shim	Shim Screw	Wrench
SSSCR/L 1616-H09	16	16	100	17	16	SC□T09T3□□	FTGA03512	SS32S	SHXN0509F	TW15P, HW35L
2020-K12	20	20	125	21	20	SC□T1204□□	FTGA0411F	SS42S	SHXN0610F	TW15P, HW40L
2525-M12	25	25	150	26	25	SC□T1204□□	FTGA0411F	SS42S	SHXN0610F	TW15P, HW40L

↻ Applicable inserts **B84, B106**

STACR/L



TC□T



90°

• R type insert (mm)

Designation	H	W	L	S	h	Insert	Screw	Shim	Shim Screw	Wrench
STACR/L 1010-E09	10	10	70	10.5	10	TC□T0902□□	FTKA02206	-	-	TW06P
1212-F11	12	12	80	12.5	12	TC□T1102□□	FTKA02565	-	-	TW07P

↻ Applicable inserts **B88~B89, B107**

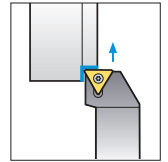
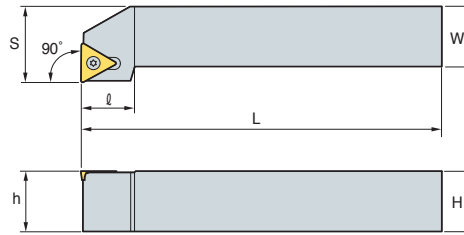


B Screw on System

STFCR/L



TC□T



90°

• R type insert (mm)

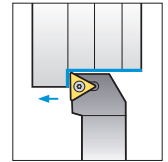
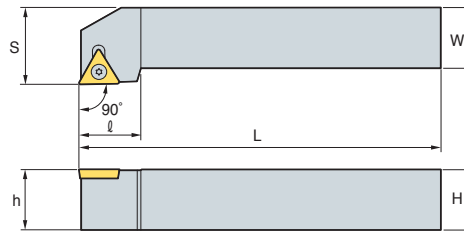
Designation	H	W	L	S	h	ℓ	Insert	Screw	Shim	Shim Screw	Wrench
STFCR/L 1010-E09	10	10	70	12	10	10	TC□T0902□□	FTKA02206	-	-	TW06P
	12	12	80	16	12	14	TC□T1102□□	FTKA02565	-	-	TW07P
1616-H11	16	16	100	20	16	14	TC□T16T3□□	FTGA03512	ST32S	SHXN0509F	TW15P, HW35L
1616-H16	16	16	100	20	16	19		FTGA03512	ST32S	SHXN0509F	TW15P, HW35L
2020-K16	20	20	125	25	20	19	TC□T16T3□□	FTGA03512	ST32S	SHXN0509F	TW15P, HW35L
2525-M16	25	25	150	32	25	25.2		FTGA03512	ST32S	SHXN0509F	TW15P, HW35L

➔ Applicable inserts B88~B89, B107

STGCR/L



TC□T



90°

• R type insert (mm)

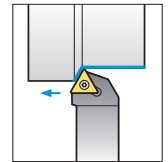
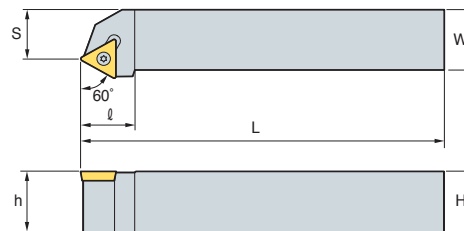
Designation	H	W	L	S	h	ℓ	Insert	Screw	Shim	Shim Screw	Wrench
STGCR/L 0808-D09	08	08	60	10	08	11	TC□T0902□□	FTKA02206	-	-	TW06P
	10	10	70	12	10	11	TC□T1102□□	FTKA02565	-	-	TW07P
1212-F11	12	12	80	16	12	14	TC□T16T3□□	FTGA03512	ST32S	SHXN0509F	TW15P, HW35L
1616-H11	16	16	100	20	16	16		FTGA03512	ST32S	SHXN0509F	TW15P, HW35L
1616-H16	16	16	100	20	16	21	TC□T16T3□□	FTGA03512	ST32S	SHXN0509F	TW15P, HW35L
2020-K16	20	20	125	25	20	21		FTGA03512	ST32S	SHXN0509F	TW15P, HW35L
2525-M16	25	25	150	32	25	21	TC□T16T3□□	FTGA03512	ST32S	SHXN0509F	TW15P, HW35L

➔ Applicable inserts B88~B89, B107

STTCR/L



TC□T



60°

• R type insert (mm)

Designation	H	W	L	S	h	ℓ	Insert	Screw	Shim	Shim Screw	Wrench
STTCR/L 1616-H11	16	16	100	13	16	14	TC□T1102□□	FTKA02565	-	-	TW07P
	16	16	100	13	16	19	TC□T16T3□□	FTGA03512	ST32S	SHXN0509F	TW15P, HW35L
2020-K16	20	20	125	17	20	19	TC□T16T3□□	FTGA03512	ST32S	SHXN0509F	TW15P, HW35L

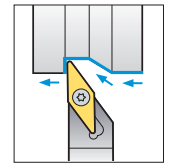
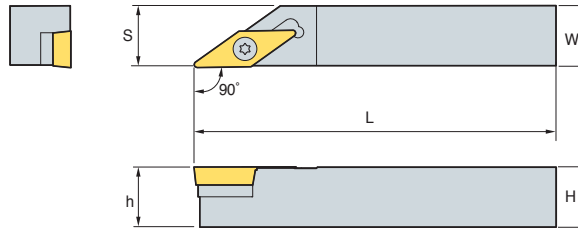
➔ Applicable inserts B88~B89, B107



SVABR/L



VB□T



90°

• R type insert (mm)

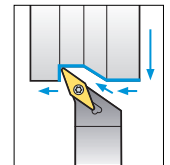
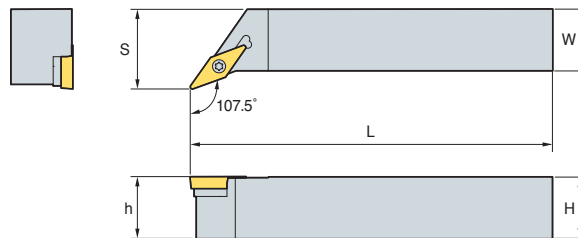
Designation	H	W	L	S	h	Insert	Screw	Shim	Shim Screw	Wrench
SVABR/L 1616-H16	16	16	100	16.5	16	VB□T1604□□	FTGA03512	SV32S	SHXN0509F	TW15P, HW35L
2020-K16	20	20	125	20.5	20					

↻ Applicable inserts B94~B96, B108

SVHBR/L



VB□T



107.5°

• R type insert (mm)

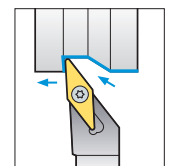
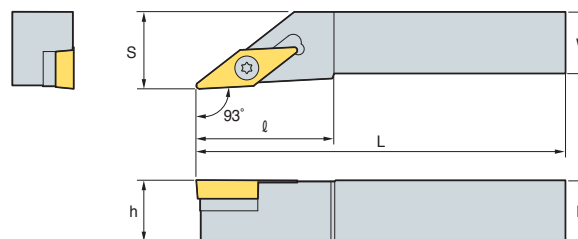
Designation	H	W	L	S	h	Insert	Screw	Shim	Shim Screw	Wrench
SVHBR/L 2525-M16	25	25	150	32	25	VB□T1604□□	FTGA03512	SV32S	SHXN0509F	TW15P, HW35L
3225-P16	32	25	170	32	32					

↻ Applicable inserts B94~B96, B108

SVJBR/L



VB□T



93°

• R type insert (mm)

Designation	H	W	L	S	h	l	Insert	Screw	Shim	Shim Screw	Wrench
SVJBR/L 1212-F11	12	12	80	16	12	27	VB□T1102□□	FTKA02565	-	-	TW07P
1616-H11	16	16	100	20	16	27					
2020-K11	20	20	125	25	20	27					
1616-H16	16	16	100	20	16	36	VB□T1604□□	FTGA03512	SV32S	SHXN0509F	TW15P, HW35L
2020-K16	20	20	125	25	20	41					
2525-M16	25	25	150	32	25	41	VB□T1604□□	FTGA03512	SV32S	SHXN0509F	TW15P, HW35L
3225-P16	32	25	170	32	32	55					
3232-P16	32	32	170	40	33	55					

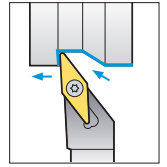
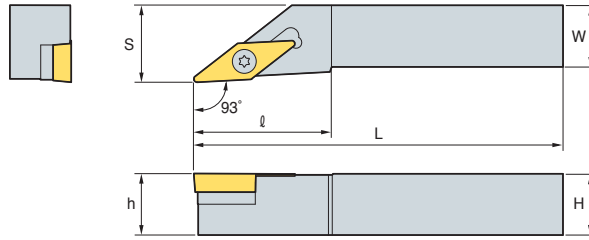
↻ Applicable inserts B94~B96, B108



SVJCR/L



VC□T



93°

• R type insert (mm)

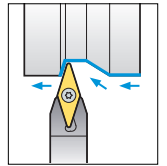
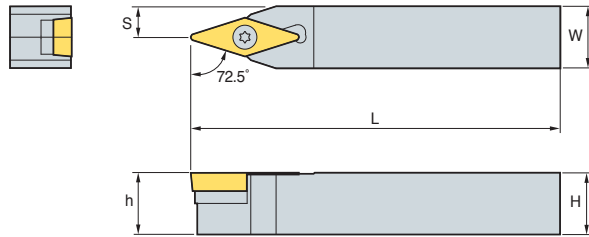
Designation	H	W	L	S	h	ℓ	Insert	Screw	Shim	Shim Screw	Wrench
SVJCR/L	1212-F11	12	12	80	16	12	VC□T1103□□	FTKA02565	-	-	TW07P
	1616-H11	16	16	100	20	16					
	2020-K11	20	20	125	25	20					
	1212-F13	12	12	80	16	12	VC□T1303□□	FTKA0307	-	-	TW09P
	1616-H13	16	16	100	20	16					
	2020-K13	20	20	125	25	20					
	1616-H16	16	16	100	20	16	VC□T1604□□	FTGA03512	SV32S	SHXN0509F	TW15P, HW35L
	2020-K16	20	20	125	25	20					
	2525-M16	25	25	150	32	25					

➔ Applicable inserts B97~B99, B109

SVVBN



VB□T



72.5°

(mm)

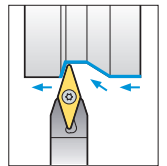
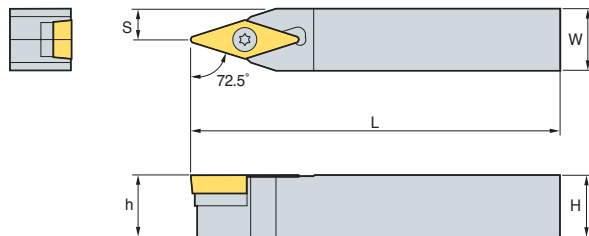
Designation	H	W	L	S	h	Insert	Screw	Shim	Shim Screw	Wrench	
SVVBN	1212-F11	12	12	80	6	12	VB□T1102□□	FTKA02565	-	-	TW07P
	1616-H11	16	16	100	8	16					
	2020-K11	20	20	125	10	20					
	1616-H16	16	16	100	8	16	VB□T1604□□	FTGA03512	SV32S	SHXN0509F	TW15P, HW35L
	2020-K16	20	20	125	10	20					
	2525-M16	25	25	150	12.5	25					
	3225-P16	32	25	170	12.5	32					

➔ Applicable inserts B94~B96, B108

SVVCN



VC□T



72.5°

(mm)

Designation	H	W	L	S	h	Insert	Screw	Shim	Shim Screw	Wrench	
SVVCN	1212-F11	12	12	80	6	12	VC□T1103□□	FTKA02565	-	-	TW07P
	1616-H11	16	16	100	8	16					
	2020-K11	20	20	125	10	20					
	1212-F13	12	12	80	6	12	VC□T1303□□	FTNA0307	-	-	TW09P
	1616-H13	16	16	100	8	16					
	2020-K13	20	20	125	10	20					
	1616-H16	16	16	100	8	16	VC□T1604□□	FTGA03512	SV32S	SHXN0509F	TW15P, HW35L
	2020-K16	20	20	125	10	20					
	2525-M16	25	25	150	12.5	25					

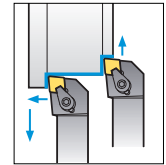
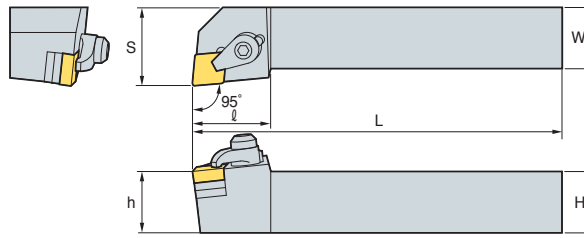
➔ Applicable inserts B97~B99, B109



CCLNR/L



CN□N



95°

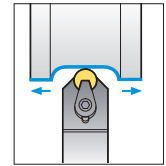
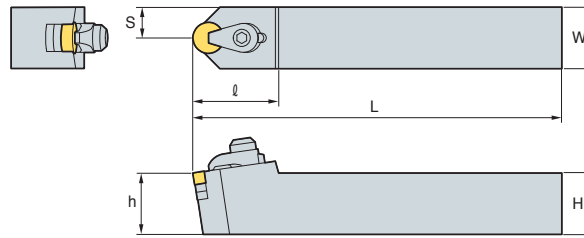
• R type insert
(mm)

Designation	H	W	L	S	h	ℓ	Insert	Clamp	Screw	Shim	Spring	Wrench
CCLNR/L 2525-M12C	25	25	150	32	25	32	CN□N1204□□ CN□N1207□□	CH6R3	MHX0630 SHX0310	SC42CC	SR3	HW40L HW20L

CRDNN



RN□N



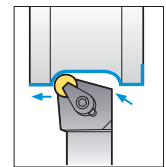
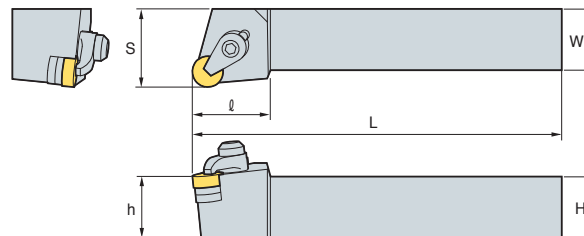
(mm)

Designation	H	W	L	S	h	ℓ	Insert	Clamp	Screw	Shim	Spring	Wrench
CRDNN 2525-M12C	25	25	150	12.5	25	35	RN□N1204□□ RN□N1207□□	CH6R3	MHX0630 SHX0310	SC42CC	SR3	HW40L HW20L

CRGNR/L



RN□N



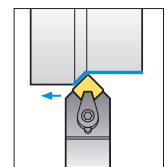
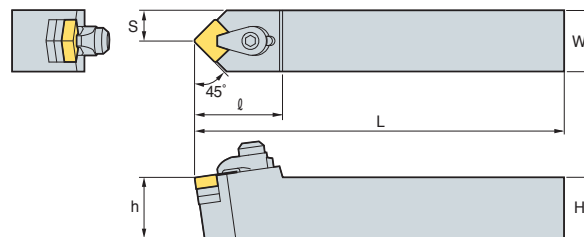
• R type insert
(mm)

Designation	H	W	L	S	h	ℓ	Insert	Clamp	Screw	Shim	Spring	Wrench
CRGNR/L 2525-M12C	25	25	150	32	25	32	RN□N1204□□ RN□N1207□□	CH6R3	MHX0630 SHX0310	SC42CC	SR3	HW40L HW20L

CSDNN



SN□N



45°

(mm)

Designation	H	W	L	S	h	ℓ	Insert	Clamp	Screw	Shim	Spring	Wrench
CSDNN 2525-M12C	25	25	125	12.5	25	35	SN□N1204□□ RN□N1207□□	CH6R3	MHX0630 SHX0310	SS42CC	SR3	HW40L HW20L

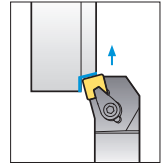
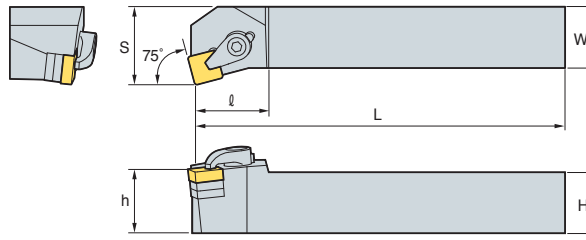


B Ceramic Holder

CSKNR/L



SN□N



75°

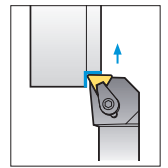
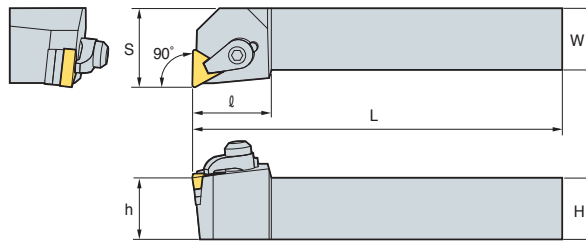
• R type insert
(mm)

Designation	H	W	L	S	h	l	Insert	Clamp	Screw	Shim	Spring	Wrench
CSKNR/L 2525-M12C	25	25	150	32	25	28	SN□N1204□□ SN□N1207□□	CH6R3	MHX0630 SHX0310	SS42CC	SR3	HW40L HW20L

CTFNRL



TN□N



90°

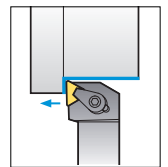
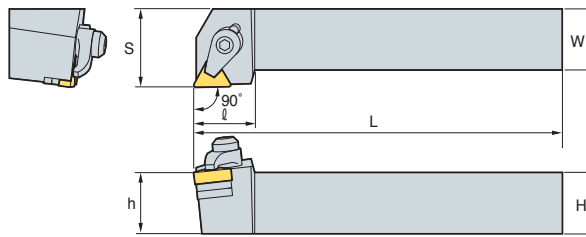
• R type insert
(mm)

Designation	H	W	L	S	h	l	Insert	Clamp	Screw	Shim	Spring	Wrench
CTFNRL 2525-M16C	25	25	150	32	25	32	TN□N1604□□ TN□N1607□□	CH6R3	MHX0630 SHX0310	ST32CC	SR3	HW40L HW20L

CTGNRL



TN□N



90°

• R type insert
(mm)

Designation	H	W	L	S	h	l	Insert	Clamp	Screw	Shim	Spring	Wrench
CTGNRL 2525-M16C	25	25	150	32	25	32	TN□N1604□□ TN□N1607□□	CH6R3	MHX0630 SHX0310	ST32CC	SR3	HW40L HW20L



Note) Generally, two shims are clamped to a Ceramic Holder.

However, only one shim is used in clamping 1207□□ and 1607□□ sized inserts.



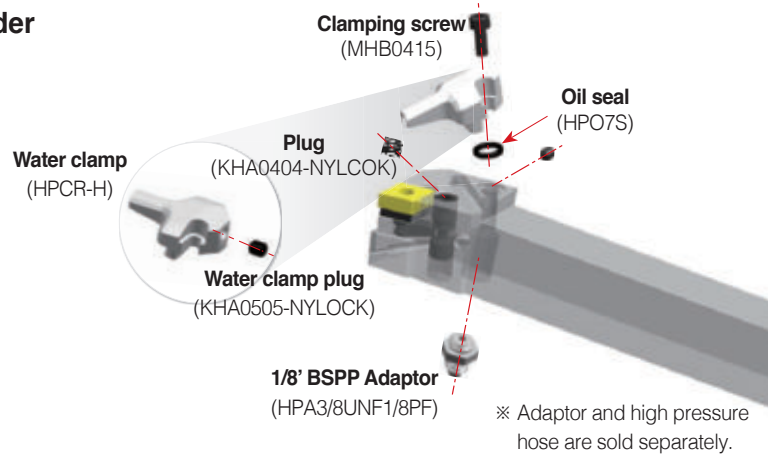
KORLOY High Pressure Coolant

KHP Coolant **new**

ISO turning holder

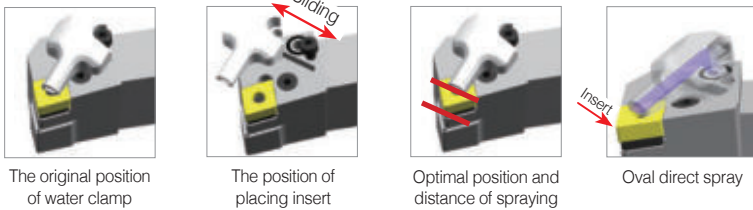
- 300% increased productivity on Inconel machining vs. low pressure coolant system
- Cooling, tool life, and chip control are improved by the high volume coolant multi-directional injection system

Structure of Holder



Features

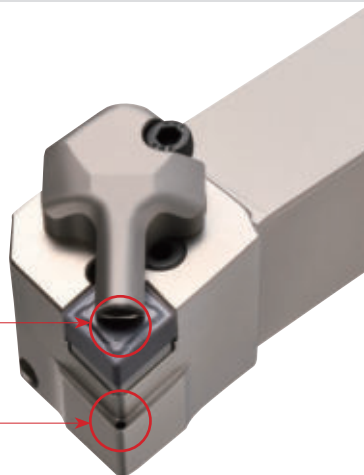
- The optimal distance between the insert and the jet orifice and the ideal place of the jet orifice
- Maximized loss pressure of coolant pressure due to streamlined design of internal path
- Easy to clamp an insert for sliding clamp system



MAX 300 bar

Workpiece	The minimum pressure	The maximum pressure
P	50	300
M	70	
K	60	
N	50	
S	70	

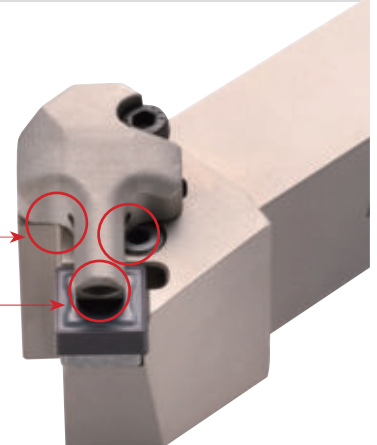
Water clamp with a hole



Spray to the upper surface of insert
 Spray to the bottom surface of insert

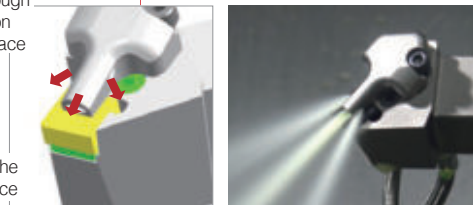


Water clamp with three holes



Injection through three holes on the rake surface

Injection on the bottom surface

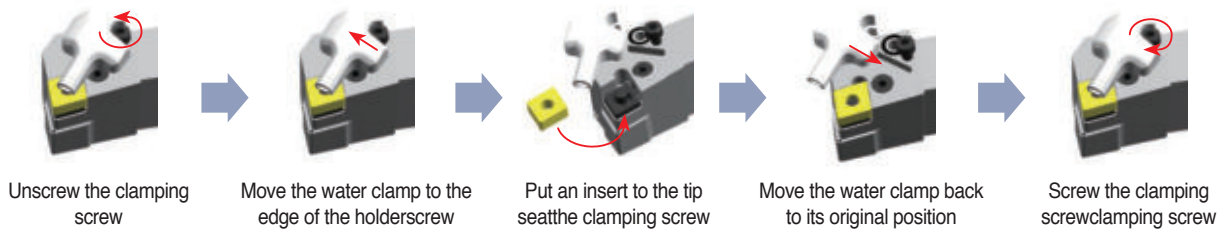


※ Clamp is sold separately

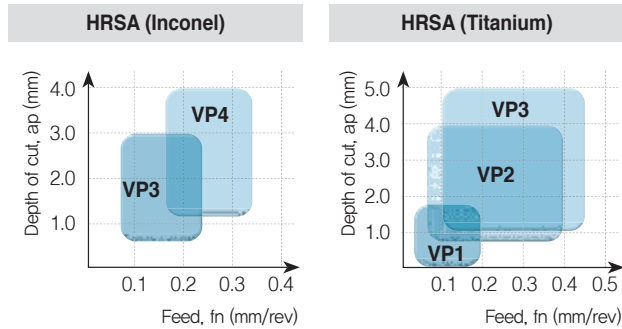


B Technical Information for KHP Coolant

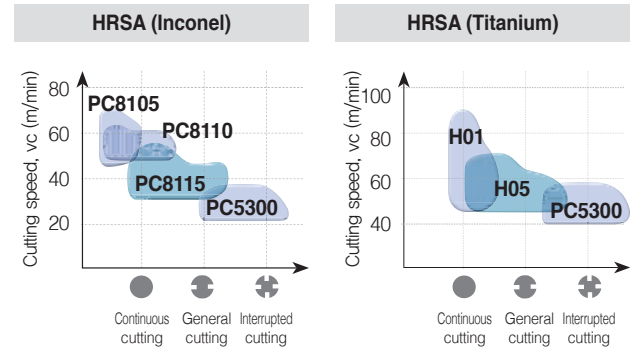
How to use the water clamp



Application range



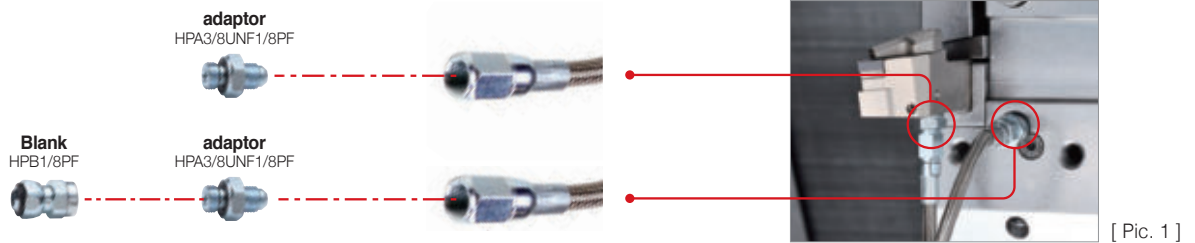
Grade Line-up



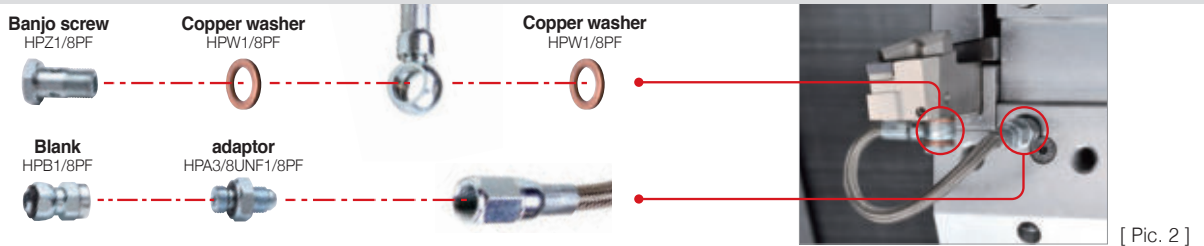
How to clamp the KHP Coolant

- 3 types of installation systems makes clamping easy
- The banjo type hose provides wider area for machining than other types

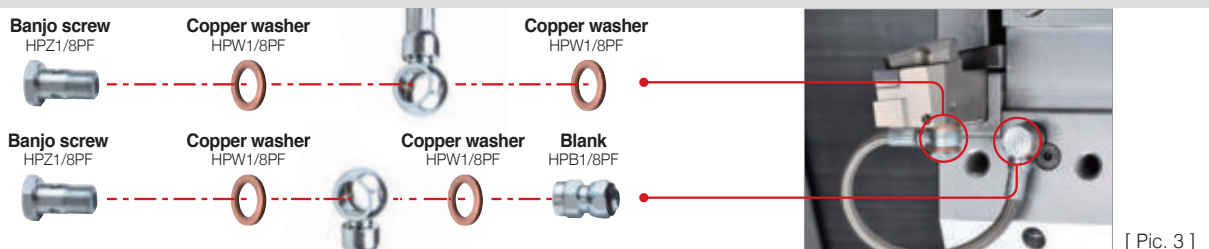
Straight to straight (S-S)



Straight to banjo (S-B)



Banjo to banjo (B-B)






- ※ Blank including a fixed oil seal provides easy clamping
- ※ Banjo screws provide easy clamping and clamping a holder to the turning machine with various types of blanks


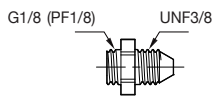

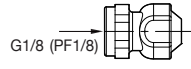

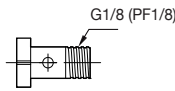




Components of KHP Coolant




- The components of high pressure coolant are sold separately
- Various components are available according to different machining sites and uses machining with high pressure coolant

Designation	Shape	Hose length	High pressure hose	Blank	Adaptor	Banjo screw	Copper washer	Pic.		
HPH3/8UNF-200-SET		200 mm	1 EA	1 EA	2 EA	-	-	1		
HPH3/8UNF-250-SET		250 mm								
HPH3/8UNF1/8PF-200-SET		200 mm			1 EA	1 EA	1 EA	1 EA	3 EA	2
HPH3/8UNF1/8PF-250-SET		250 mm								
HPH1/8PF-200-SET		200 mm			-	2 EA	5 EA	3		
HPH1/8PF-250-SET		250 mm								

KHP Coolant Parts

Division	Designation	Shape
adaptor	HPA3/8UNF1/8PF	 
Blank	HPB1/8PF	 
Banjo screw	HPZ1/8PF	 
Copper washer	HPW1/8PF	 

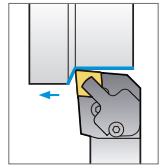
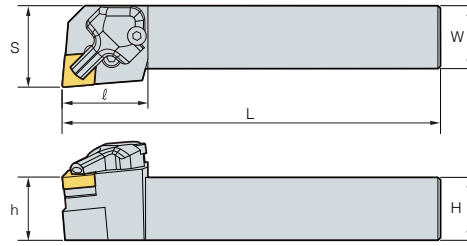
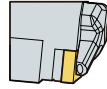
KHP Coolant High pressure hose

High pressure hose shape		Length	S	B
Straight to straight (HPH3/8UNF)		200 mm	UNF3/8	-
		250 mm		
Straight to banjo (HPH3/8UNF1/8PF)		200 mm	UNF3/8	Internal Ø10
		250 mm		
Banjo to banjo (HPH1/8PF)		200 mm	-	Internall Ø10
		250 mm		

PCLNR/L



CN□□



95°

• R type insert (mm)

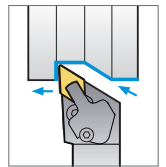
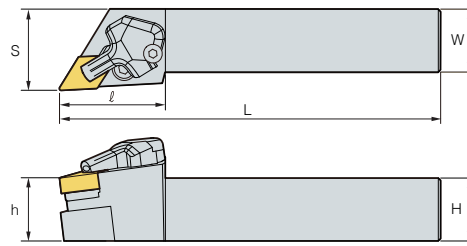
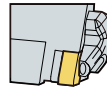
Designation	H	W	L	S	h	l	Insert	Lever	Screw	Shim	Ship pin	Shim Pin Punch	Clamp	Clamping screw	Oil seal	Plug	Wrench
PCLNR/L 2525-M12-KHP	25	25	150	32	25	34	CN□□1204□□										
3232-P12-KHP	32	32	170	40	32	34											

➔ Applicable inserts B36~B42

PDJNR/L



DN□□



93°

• R type insert (mm)

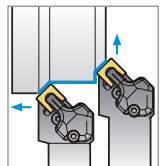
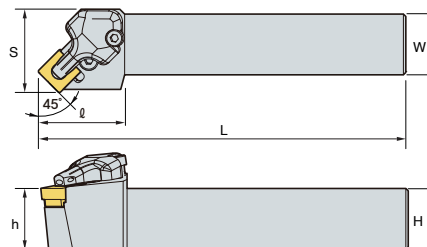
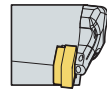
Designation	H	W	L	S	h	l	Insert	Lever	Screw	Shim	Ship pin	Shim Pin Punch	Clamp	Clamping screw	Oil seal	Plug	Wrench										
PDJNR/L 2525-M11-KHP	25	25	150	32.25	25	42	DN□□1104□□																				
2525-M1504-KHP	25	25	150	32.25	25	42	DN□□1504□□											LV3AN	VHX0617N	SD32N	SP3	LSPS3	HPCR/L-H	MHB0415	HPO7S	KHA0404-NYLOCK	HW20L HW25L HW30L
2525-M1506-KHP	25	25	150	32.25	25	42	DN□□1506□□											LV4BN	VHX0821N	SD43N	SP4N	LSPS4	HPCR/L-H	MHB0415	HPO7S	KHA0404-NYLOCK	HW20L HW30L

➔ Applicable inserts B43~B48

PSSNR/L



SN□□



45°

• R type insert (mm)

Designation	H	W	L	S	h	l	Insert	Lever	Screw	Shim	Ship pin	Shim Pin Punch	Clamp	Clamping screw	Oil seal	Plug	Wrench
PSSNR/L 2525-M12-KHP	25	25	150	34.25	25	35.5	SN□□1204□□										
								LV4N	VHX0821	SS42N	SP4N	LSPS4	HPCR/L-3H	MHB0415	HPO7S	KHA0404-NYLOCK	HW20L HW30L

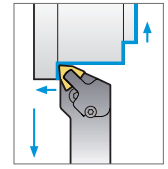
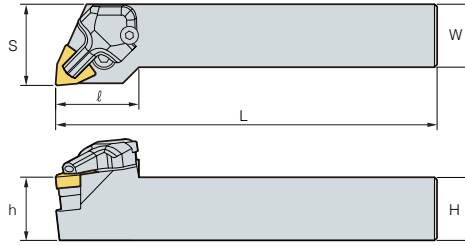
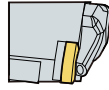
➔ Applicable inserts B50~B57



PWLNRL/L



WN□□



95°

• R type insert (mm)

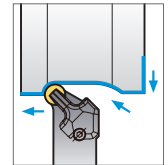
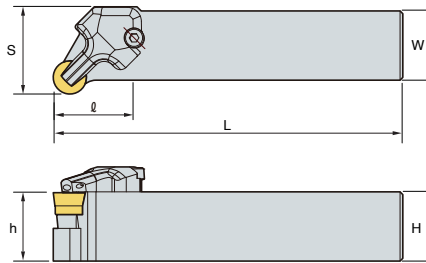
Designation	H	W	L	S	h	ℓ	Insert	Lever	Screw	Shim	Shim pin	Shim Pin Punch	Clamp	Clamping screw	Oil seal	Plug	Wrench
PWLNRL 2525-M08-KHP	25	25	150	32.25	25	33	WN□□0804□□										
3232-P08-KHP	32	32	170	39.25	32	33											

➔ Applicable inserts B68~B72

SRGCR/L



RCGT



• R type insert (mm)

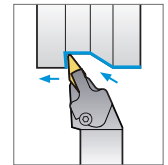
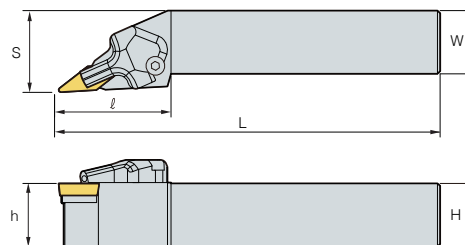
Designation	H	W	L	S	h	ℓ	Insert	Screw	Shim	Shim Screw	Clamp	Clamping screw	Oil seal	Wrench
SRGCR/L 2525-M12-KHP	25	25	150	31.5	25	-	RCGT1204M0							
								FTGA03512	SR12S	SHXN0509F	HPCR/L-3H	MHB0415	HPO7S	HW15P HW30L HW35L

➔ Applicable inserts B83, B105

SVJBR/L



VB□□



93°

• R type insert (mm)

Designation	H	W	L	S	h	ℓ	Insert	Screw	Shim	Shim Screw	Clamp	Clamping screw	Oil seal	Wrench
SVJBR/L 2525-M16-KHP	25	25	150	32.5	25	46.5	VB□□1604□□							
								FTGA03512	SV32S	SHXN0509F	HPCR/L-H	MHB0415	HPO7S	TW15P HW30L HW35L

➔ Applicable inserts B94~B96, B108

B Boring Bar Code System (ISO)

S 12 M - S T F P R - 11

1

2

3

4

5

6

7

8

9

Type of Bar

Bar Diameter

Bar Length

Method of Mounting Insert

Insert Shape

Lead Angle of Boring Bar

Relief Angle of Insert

Hand of Bar

Length of Cutting Edge

1 Type of Bar

S 12 M - S T F P R - 11

"A" Steel with coolant hole

"E" Carbide bar with fixed steel head and coolant hole

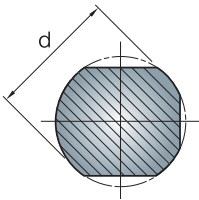
"C" Carbide shank

"S" Steel shank

"X" Special type

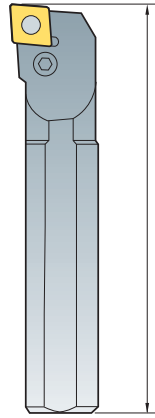
2 Bar Diameter

S 12 M - S T F P R - 11



3 Bar Length

S 12 M - S T F P R - 11



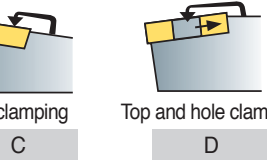
Symbol(L)	length(mm)
H	100
J	110
K	125
M	150
N	160
Q	180
R	200
S	250
T	300
U	350
V	400
W	450
Y	500

4 Method of Mounting Insert

S 12 M - S T F P R - 11



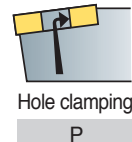
Top clamping



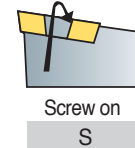
Top and hole clamping



Top and hole clamping



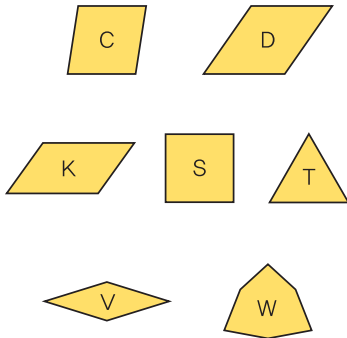
Hole clamping



Screw on

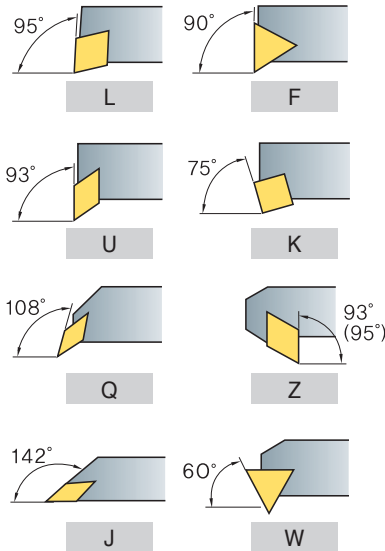
5 Insert Shape

S 12 M - S T F P R - 11



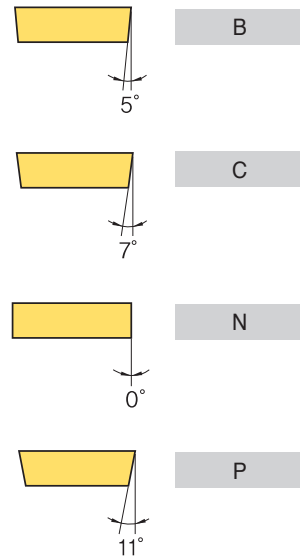
6 Lead Angle of Boring Bar

S 12 M - S T F P R - 11



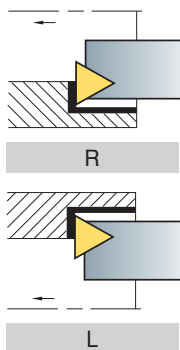
7 Relief Angle of Insert

S 12 M - S T F P R - 11



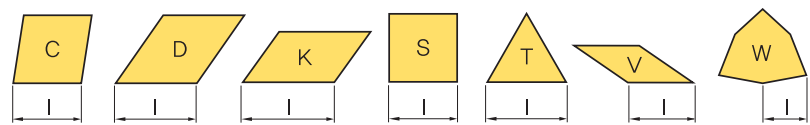
8 Hand of Bar

S 12 M - S T F P R - 11



9 Length of Cutting Edge

S 12 M - S T F P R - 11



Double Clamp System

Cutting Shape								
Designation	DCLNR/L	DDUNR/L	DSKNR/L	DTFNR/L	DWLNR/L			
Approach angle	95°	93°	75°	90°	95°			
Page	B208	B208	B208	B209	B209			
Copying		●						
Facing	●				●			
Back turning		●						
Turning	●	●	●	●	●			

Lever Lock System

Cutting Shape								
Designation	PCLNR/L	PDSNR/L	PDUNR/L	PSKNR/L	PTFNR/L	PWLNR/L		
Approach angle	95°	62.5°	93°	75°	90°	95°		
Page	B210	B210	B210	B211	B211	B211		
Copying		●	●					
Facing	●					●		
Back turning		●	●			●		
Turning	●	●	●	●	●	●		

Clamp on System

Cutting Shape								
Designation	CKUNR/L	CSKPR/L	CTFPR/L					
Approach angle	93°	75°	90°					
Page	B212	B212	B212					
Copying								
Facing								
Back turning	●							
Turning	●	●	●					

Multi Lock System

Cutting Shape								
Designation	MCLNR/L	MDUNR/L	MSKNR/L	MTFNR/L	MVUNR/L	MWLNR/L		
Approach angle	95°	93°	75°	90°	93°	95°		
Page	B213	B213	B213	B214	B214	B214		
Copying		●			●			
Facing	●					●		
Back turning		●			●			
Turning	●	●	●	●	●	●		

B Index for Boring Bar

Screw on System

Cutting Shape								
Designation	SCLCR/L	SCLPR/L	SDQCR/L	SDUCR/L	SDZCR/L	SSKCR/L	SSKPR/L	STFCR/L
Approach angle	95°	95°	107.5°	93°	93°	75°	75°	90°
Page	B215	B216	B217	B218	B219	B219	B219	B220
Copying			●	●				
Facing	●	●						
Back turning			●	●	●			
Turning	●	●	●	●	●	●	●	●

Cutting Shape								
Designation	STFPR/L	STWPR/L	SVJCR/L	SVQBR/L	SVQCR/L	SVUBR/L	SVUCR/L	SWLCR/L
Approach angle	90°	60°	142°	108°	108°	93°	93°	95°
Page	B221	B222	B222	B222	B223	B223	B223	B224
Copying			●	●	●	●	●	●
Facing								
Back turning				●	●	●	●	●
Turning	●	●	●	●	●	●	●	●

Compact Mini

Cutting Shape								
Designation	SCLCR/L	STUBR/L	STLBR/L	STUPR/L	SWUBR/L			
Approach angle	95°	93°	95°	93°	93°			
Page	B225	B225	B225	B226	B227			
Copying								
Facing	●	●	●					
Back turning				●				
Turning	●	●	●	●	●			

Carbide Shank Boring Bar

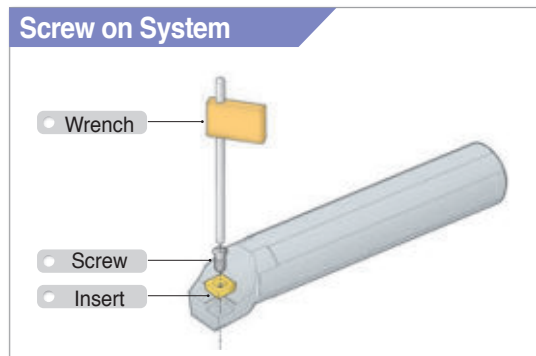
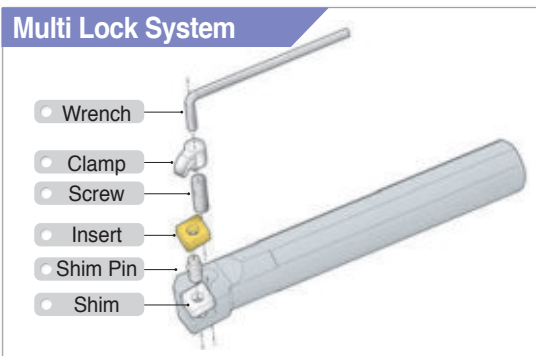
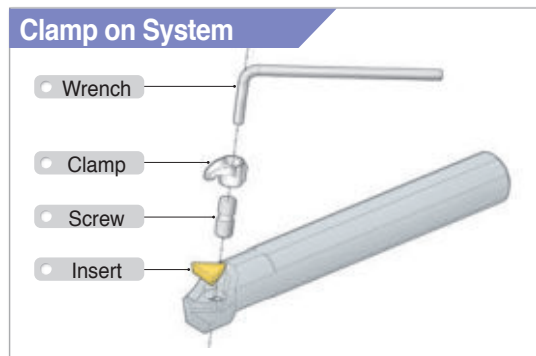
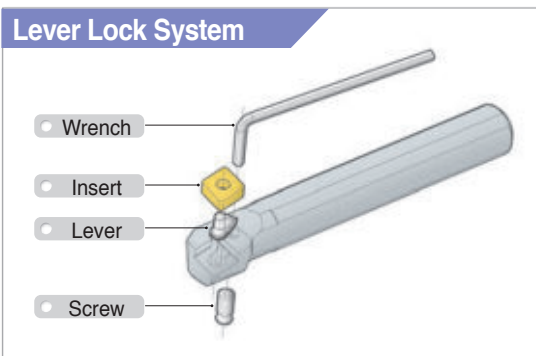
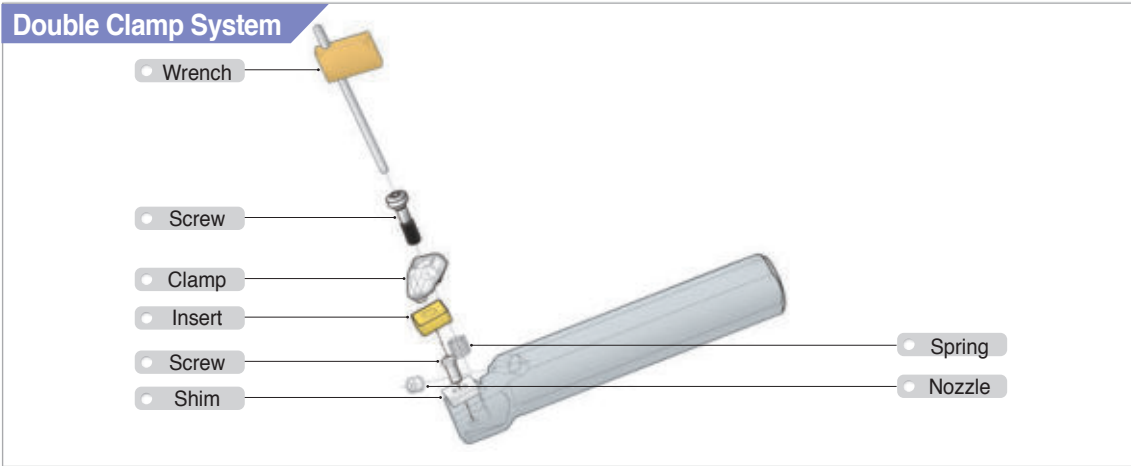
Designation	SCLCR/L	SCLPR/L	SDQCR/L	SDUCR/L	STFCR/L
Approach angle	95°	95°	107.5°	93°	90°
Page	B215	B216	B217	B218	B220
Designation	STFPR/L	STUBR/L	STUPR/L	SWUBR/L	-
Approach angle	90°	93°	93°	93°	-
Page	B221	B225	B226	B227	-

Sleeve

Shape	
Designation	SL
Page	B151



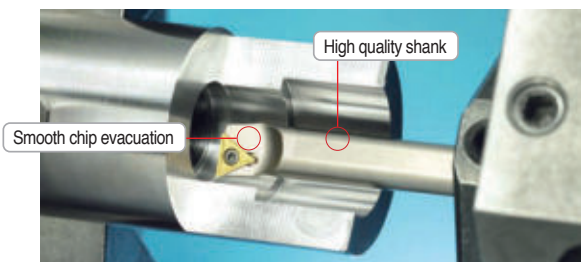
Instructions of Boring Bar assembly



Carbide Shank Boring Bar

- Excellent cutting performance even in internal machining with chattering
- Available for various workpieces such as steel, stainless steel, cast iron, etc.
- Improved tool life and surface roughness

Features



Higher strength and durability than steel shank, special surface treatment applied

Comparison of chipping

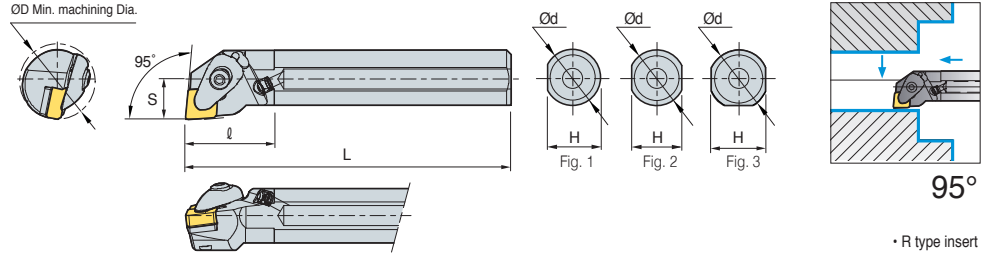
Specifications	Steel boring bar			Carbide boring bar		
• SCM440						
• v_c (m/min) = 200						
• a_p (mm) = 0.4						
• f_n (mm/rev) = 0.15						
• Cutting depth: 5D						
	Rmax	Rz	Ra	Rmax	Rz	Ra
	4.67	3.68	0.62	3.07	2.76	0.53

B Double Clamp System

DCLNR/L



CN□□



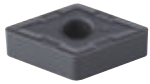
95°

• R type insert (mm)

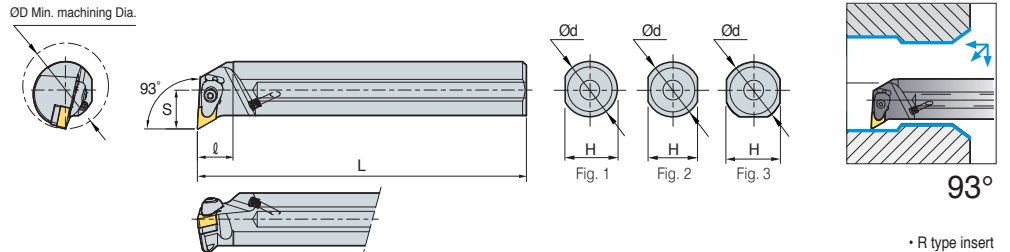
Designation	ØD	Ød	H	L	S	l	Insert	Clamp	Clamp Screw	Shim	Shim Screw	Spring	Nozzle	Wrench	Fig.
A25R-DCLNR/L-09	32	25	24	200	17	40	CN□□0903□□	CVH3	CHX0415	SC32V	FTKA0307	SPR0510	CN0605	HW25P	1
A25R-DCLNR/L-12	32	25	24	200	17	40	CN□□1204□□	CVH4	CHX0518	SC42V	FTKA0410	SPR0714	CN0605	HW30P	1
A32S-DCLNR/L-12	40	32	30	250	22	50									3
A40T-DCLNR/L-12	50	40	38	300	27	60									
A50U-DCLNR/L-16	63	50	48	350	35	70	CN□□1606□□	CVH5	CHX0622	SC54V	FTNA0511	SPR0811	CN0605	HW40L	3

➔ Applicable inserts B36~B42

DDUNR/L



DN□□



93°

• R type insert (mm)

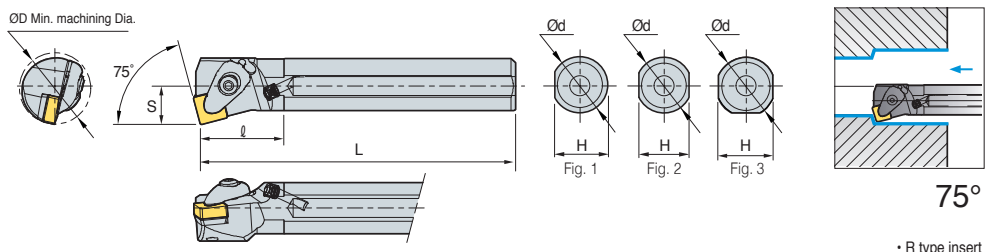
Designation	ØD	Ød	H	L	S	l	Insert	Clamp	Clamp Screw	Shim	Shim Screw	Spring	Nozzle	Wrench	Fig.
A40T-DDUNR/L-15	50	40	38	300	27	60	DN□□1506□□	CVH4	CHX0518	SD43V	FTKA0410	SPR0714	CN0605	HW30P	3
A50U-DDUNR/L-15	63	50	47	350	35	70									
A40T-DDUNR/L-15 -3	50	40	37	300	25	60	DN□□1504□□	CVH4	CHX0518	SD44V	FTKA0410	SPR0714	CN0605	HW30P	3
A50U-DDUNR/L-15 -3	63	50	47	350	35	70									

➔ Applicable inserts B43~B48

DSKNR/L



SN□□



75°

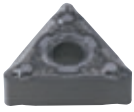
• R type insert (mm)

Designation	ØD	Ød	H	L	S	l	Insert	Clamp	Clamp Screw	Shim	Shim Screw	Spring	Nozzle	Wrench	Fig.
A25R-DSKNR/L-09	32	25	24	200	17	40	SN□□0903□□	CVH3	CHX0415	SS32V	FTKA0307	SPR0510	CN0605	HW25P	1
A25R-DSKNR/L-12	32	25	24	200	17	40	SN□□1204□□	CVH4	CHX0518	SS42V	FTKA0410	SPR0714	CN0605	HW30P	1
A32S-DSKNR/L-12	40	32	30	250	22	50									3
A40T-DSKNR/L-12	50	40	38	300	27	60									

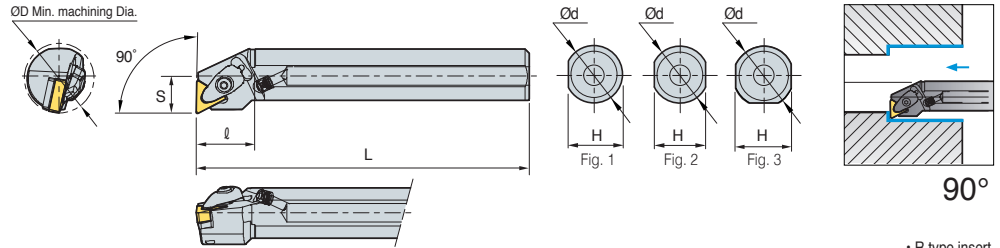
➔ Applicable inserts B50~B57



DTFNR/L



TN□□



• R type insert (mm)

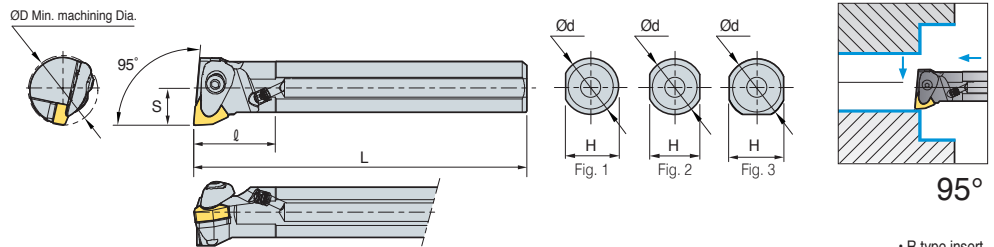
Designation	ØD	Ød	H	L	S	ℓ	Insert	Clamp	Clamp Screw	Shim	Shim Screw	Spring	Nozzle	Wrench	Fig.
A25R-DTFNR/L-16	32	25	24	200	17	40	TN□□1604□□								1
A32S-DTFNR/L-16	40	32	30	250	22	50	TN□□2204□□								3
A40T-DTFNR/L-22	50	40	38	300	27	60									3
A50U-DTFNR/L-22	63	50	47	350	35	70									

↻ Applicable inserts B58~B65

DWLNR/L



WN□□



• R type insert (mm)

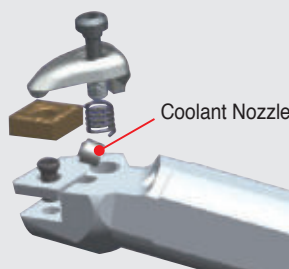
Designation	ØD	Ød	H	L	S	ℓ	Insert	Clamp	Clamp Screw	Shim	Shim Screw	Spring	Nozzle	Wrench	Fig.
A25R-DWLNR/L-06	32	25	24	200	17	40	WN□□0604□□								1
A32S-DWLNR/L-06	40	32	30	250	22	50									3
A40T-DWLNR/L-06	50	40	38	300	27	60									
A25R-DWLNR/L-08	32	25	24	200	17	40	WN□□0804□□								1
A32S-DWLNR/L-08	40	32	30	250	22	50									3
A40T-DWLNR/L-08	50	40	38	300	27	60									
A50U-DWLNR/L-08	63	50	47	350	35	70									

↻ Applicable inserts B68~B72



Features of Double Clamp (Boring bar)

Longer tool life and excellent surface finish can be achieved with the adjustable Coolant Nozzle

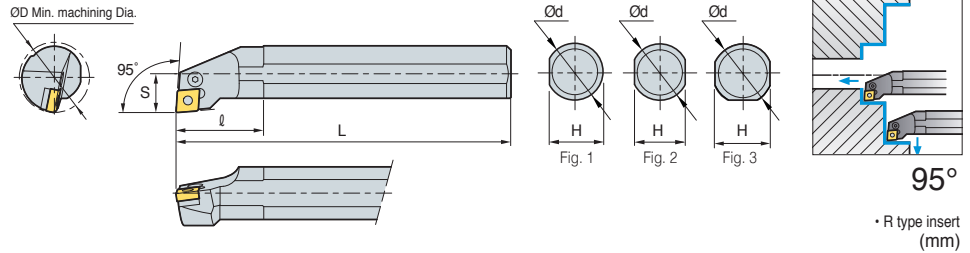


B Lever Lock System

PCLNR/L



CN□□



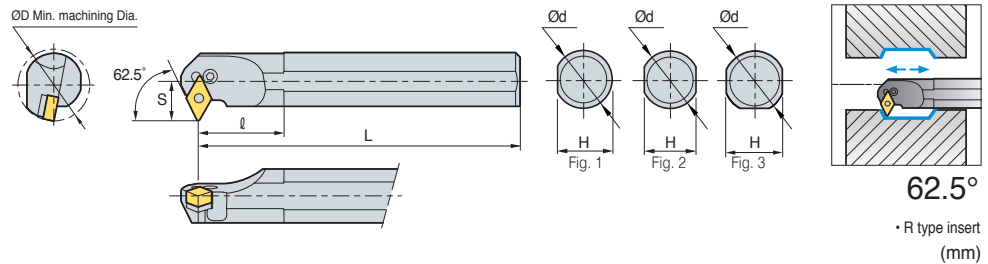
Designation	ØD	Ød	H	L	S	ℓ	Insert	Lever	Screw	Shim	Shim Pin	Shim Pin Punch	Wrench	Fig.
S16R-PCLNR/L-09	20	16	14	200	11	25	CN□□0903□□	LV3C	VHX0509B	-	-	-	HW20L	2
S20S-PCLNR/L-09	25	20	18	250	13	32		3						
S25R-PCLNR/L-09	32	25	23	200	17	40	CN□□1204□□	LV4A	VHX0613A	-	-	-	HW25L	3
S25R-PCLNR/L-12	32	25	23	200	17	40		LV4	VHX0821	SC42B	SP4	LSPS4	HW30L	
S25T-PCLNR/L-12	32	25	23	300	17	40		LV4	VHX0821	SC43B	SP4	-	HW30L	
S32S-PCLNR/L-12	40	32	30	250	22	50		LV4	VHX0821	SC42B	SP4	LSPS4	HW30L	
S32U-PCLNR/L-12	40	32	30	350	22	50								
S40T-PCLNR/L-12	50	40	38	300	27	60								
S50U-PCLNR/L-12	63	50	47	350	35	70	CN□□1906□□	LV6	VHX1027	SC63	SP6	LSPS6	HW40L	3
S50U-PCLNR/L-19	63	50	47	350	35	70	CN□□1204□□	LV4A	VHX0613A	-	-	-	HW25L	1
A25R-PCLNR/L-12	32	25	24	200	17	40	CN□□1204□□	LV4	VHX0821	SC42B	SP4	LSPS4	HW30L	3
A32S-PCLNR/L-12	40	32	30	250	22	50								
A40T-PCLNR/L-12	50	40	38	300	27	60								

↻ Applicable inserts B36~B42

PDSNR/L



DN□□



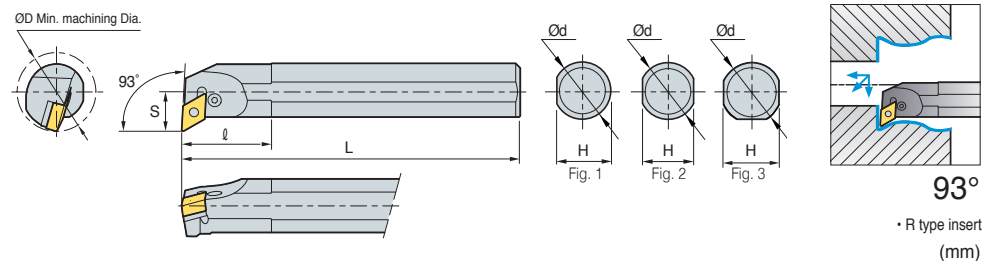
Designation	ØD	Ød	H	L	S	ℓ	Insert	Lever	Screw	Shim	Shim Pin	Shim Pin Punch	Wrench	Fig.
S32S-PDSNR/L-15	40	32	30	250	22	50	DN□□1506□□	LV4B	VHX0821	SD42	SP4	LSPS4	HW30L	3
S40T-PDSNR/L-15	50	40	38	300	27	60		LV4	VHX0821	SD42	SP4	LSPS4	HW30L	
S32S-PDSNR/L-15-3	40	32	30	250	22	50	DN□□1504□□	LV4B	VHX0821	SD42	SP4	LSPS4	HW30L	
S40T-PDSNR/L-15-3	50	40	38	300	27	60	DN□□1506□□	LV4B	VHX0821	SD42	SP4	LSPS4	HW30L	
A32S-PDSNR/L-15	40	32	30	250	22	50	DN□□1504□□	LV4	VHX0821	SD42	SP4	LSPS4	HW30L	
A32S-PDSNR/L-15-3	40	32	30	250	22	50								

↻ Applicable inserts B43~B48

PDUNR/L



DN□□



Designation	ØD	Ød	H	L	S	ℓ	Insert	Lever	Screw	Shim	Shim Pin	Shim Pin Punch	Wrench	Fig.
S32S-PDUNR/L-11	40	32	30	250	22	50	DN□□1104□□	LV3	VHX0617	SD317	SP3	LSPS3	HW25L	3
S32S-PDUNR/L-15	40	32	30	250	22	50		DN□□1506□□	LV4B	VHX0821	SD42	SP4	LSPS4	HW30L
S40T-PDUNR/L-15	50	40	38	300	27	60	DN□□1504□□	LV4	VHX0821	SD42	SP4	LSPS4	HW30L	3
S50U-PDUNR/L-15	63	50	47	350	35	70	DN□□1506□□	LV4B	VHX0821	SD42	SP4	LSPS4	HW30L	
S32S-PDUNR/L-15-3	40	32	30	250	22	50	DN□□1504□□	LV4	VHX0821	SD42	SP4	LSPS4	HW30L	
S40T-PDUNR/L-15-3	50	40	38	300	27	60	DN□□1506□□	LV4B	VHX0821	SD42	SP4	LSPS4	HW30L	
A32S-PDUNR/L-15	40	32	30	250	22	50	DN□□1504□□	LV4	VHX0821	SD42	SP4	LSPS4	HW30L	
A32S-PDUNR/L-15-3	40	32	30	250	22	50								

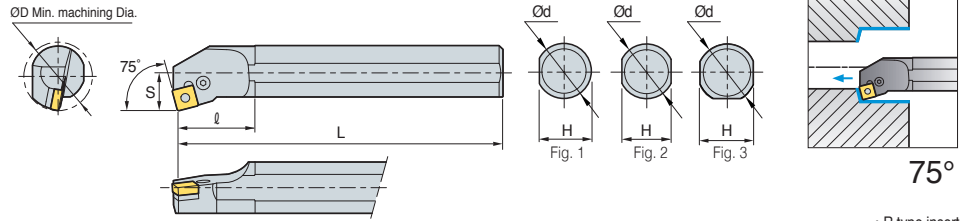
↻ Applicable inserts B43~B48



PSKNR/L



SN□□

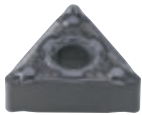


• R type insert (mm)

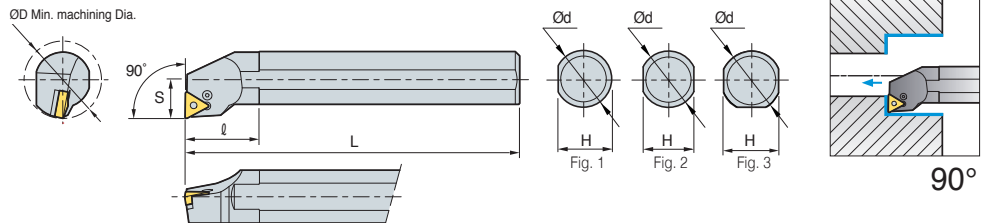
Designation	ØD	Ød	H	L	S	ℓ	Insert	Lever	Screw	Shim	Shim Pin	Shim Pin Punch	Wrench	Fig.
S25R-PSKNR/L-12	32	25	23	200	17	40	SN□□1204□□	LV4A	VHX0613A	-	-	-	HW30L	3
S32S-PSKNR/L-12	40	32	30	250	22	50		LV4	VHX0821	SS42B	SP4	LSPS4	HW30L	
S40T-PSKNR/L-12	50	40	38	300	27	60	SN□□1204□□	LV4A	VHX0613A	-	-	-	HW25L	1
A25R-PSKNR/L-12	32	25	24	200	17	40		LV4	VHX0821	SS42B	SP4	LSPS4	HW30L	3
A32S-PSKNR/L-12	40	32	30	250	22	50								

↻ Applicable inserts B50~B57

PTFNR/L



TN□□



• R type insert (mm)

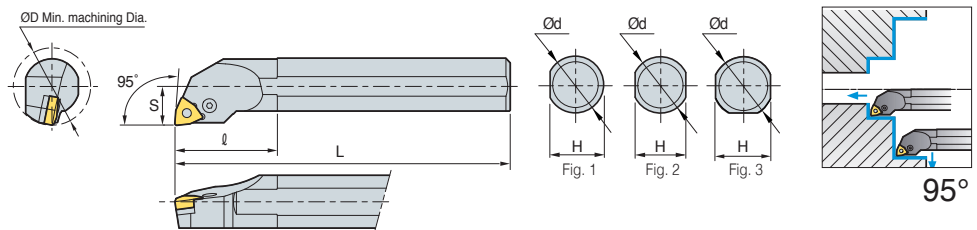
Designation	ØD	Ød	H	L	S	ℓ	Insert	Lever	Screw	Shim	Shim Pin	Shim Pin Punch	Wrench	Fig.
S16R-PTFNR/L-11	20	16	14	200	11	25	TN□□1103□□	LV2	VHX0509B	-	-	-	HW25L	2
S20S-PTFNR/L-11	25	20	18	250	13	32								3
S25R-PTFNR/L-11	32	25	23	200	17	40	TN□□1604□□	LV3B	VHX0512B	-	-	-	HW20L	3
S25R-PTFNR/L-16	32	25	23	200	17	40		LV3	VHX0617	ST317B	SP3	LSPS3	HW25L	
S32S-PTFNR/L-16	40	32	30	250	22	50		LV3	VHX0617	-	-	-	HW25L	1
S40T-PTFNR/L-16	50	40	38	300	27	60		LV3	VHX0617	ST317B	SP3	LSPS3	HW25L	3
A25R-PTFNR/L-16	32	25	24	200	17	40								
A32S-PTFNR/L-16	40	32	30	250	22	50								

↻ Applicable inserts B58~B65

PWLNR/L



WN□□



• R type insert (mm)

Designation	ØD	Ød	H	L	S	ℓ	Insert	Lever	Screw	Shim	Shim Pin	Shim Pin Punch	Wrench	Fig.
S16R-PWLNR/L-06	20	16	14	200	11	25	WNMG060408	LV3B	VHX0512B	-	-	-	HW20L	2
S20S-PWLNR/L-06	25	20	18	250	13	32	WN□□0604□□	LV3B	VHX0512B	-	-	-	HW20L	2
S25R-PWLNR/L-06	32	25	23	200	17	40		LV3	VHX0617	SW317	SP3	LSPS3	HW25L	3
S32S-PWLNR/L-06	40	32	30	250	22	50	WN□□0804□□	LV4A	VHX0613A	-	-	-	HW25L	3
S25R-PWLNR/L-08	32	25	23	200	17	40		LV4	VHX0821	SW42	SP4	LSPS3	HW30L	
S32S-PWLNR/L-08	40	32	30	250	22	50								

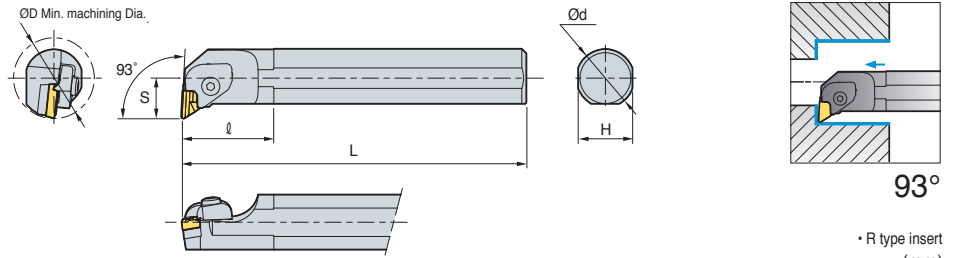
↻ Applicable inserts B68~B72

B Clamp on System

CKUNR/L



KN□□

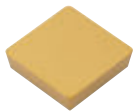


Designation	ØD	Ød	H	L	S	ℓ	Insert	Clamp	Clamp Screw	Spring	Shim	Pin+Spring	Shim Screw	Wrench							
S32S-CKUNR-16	40	32	30	250	22	70	KN□□1604□□L														
S40T-CKUNR-16	50	40	37	300	27	60									CTH6LI	CHX0625	SR3	SK33CL	PN0515 SR4	SHX0310	HW40L HW20L
S50U-CKUNR-16	63	50	43	350	35	55															
S32S-CKUNL-16	40	32	30	250	22	70	KN□□1604□□R														
S40T-CKUNL-16	50	40	37	300	27	60									CTH6RI	CHX0625	SR3	SK33C	PN0515 SR4	SHX0310	HW40L HW20L
S50U-CKUNL-16	63	50	43	350	35	55															

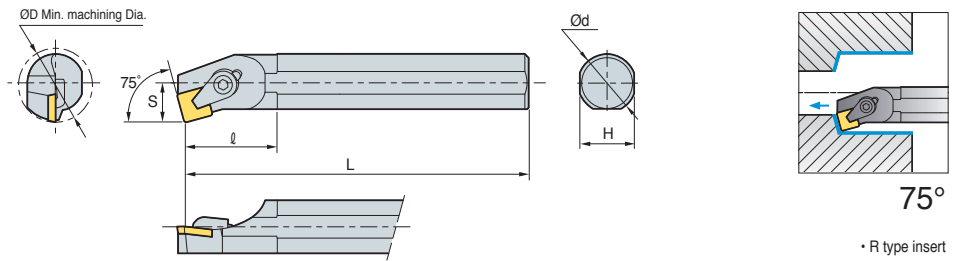
➔ Applicable inserts B49

• Use left handed insert for right handed holder

CSKPR/L



SP□□



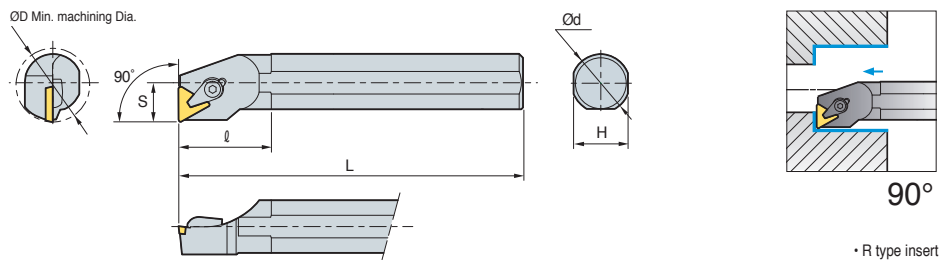
Designation	ØD	Ød	H	L	S	ℓ	Insert	Clamp	Clamp Screw	C-ring	Wrench
S16R-CSKPR/L-09	20	16	15	200	11	30	SP□□0903□□				
S20S-CSKPR/L-09	25	20	18	250	13	36					
S20S-CSKPR/L-12	25	20	18	250	13	28	SP□□1203□□				
S25R-CSKPR/L-12	32	25	23	300	17	40					
								CH6R5	CH0616	CR04C	HW30L

➔ Applicable inserts B85~B86

CTFPR/L



TP□□



Designation	ØD	Ød	H	L	S	ℓ	Insert	Clamp	Clamp Screw	C-ring	Shim	Shim Pin	Wrench						
S12M-CTFPR/L-11	16	12	11	150	9	26	TP□□1103□□												
S16R-CTFPR/L-11	20	16	15	200	11	40								CH4R1C	CHX0414C	CR02C	-	-	HW25L
S20S-CTFPR/L-11	25	20	18	250	13	40													
S16R-CTFPR/L-16	20	16	15	200	11	40	TP□□1603□□												
S20S-CTFPR/L-16	25	20	18	250	13	40								CH5R5C	CHX0519C	CR03C	-	-	HW30L
S25R-CTFPR/L-16	32	25	23	200	17	40													
S32S-CTFPR/L-16	40	32	30	250	22	45								CH6R5	CHX0622C	CR04C	ST32C	SP3C	
S40T-CTFPR/L-16	50	40	37	300	27	60	TP□□2204□□												
S40T-CTFPR/L-22	50	40	37	300	27	60								CH83R1	CH0823C	CR05C	ST43C	SP4C	HW40L

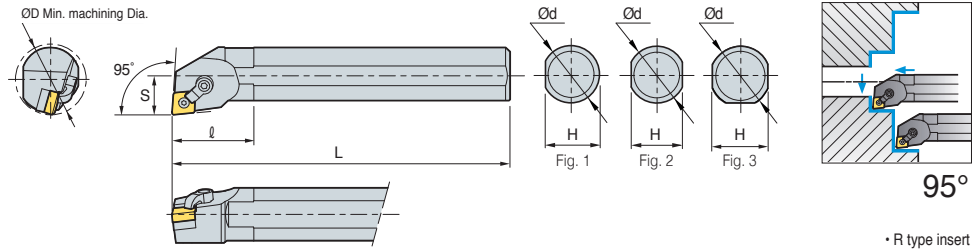
➔ Applicable inserts B90~B93



MCLNR/L



CN□□

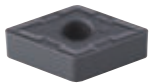


• R type insert (mm)

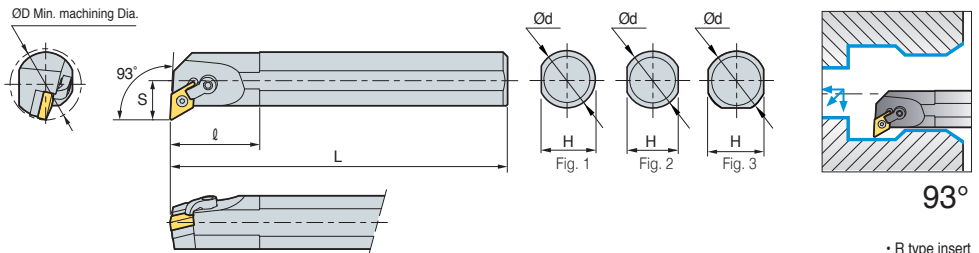
Designation	ØD	Ød	H	L	S	ℓ	Insert	Clamp	Clamp Screw	Shim	Shim Pin	Wrench	Fig.
S20S-MCLNR/L-09	25	20	18	200	13	32	CN□□0903□	CDH7N	DHA10/32-19	-	SP3D3	HW19.8L HW23.8L	2
S25R-MCLNR/L-09	32	25	23	250	17	40							3
S25R-MCLNR/L-12	32	25	23	200	17	40	CN□□1204□	CDH6N	DHA1/4-21	SC43D	SP4DS	HW31.8L HW23.8L	3
S32S-MCLNR/L-12	40	32	30	250	22	50							
S40T-MCLNR/L-12	50	40	38	300	27	60	CN□□1204□	CDH6N	DHA1/4-21	-	SP4DS	HW31.8L	1
A25R-MCLNR/L-12	32	25	24	200	17	40							3
A32S-MCLNR/L-12	40	32	30	250	22	50							

➔ Applicable inserts B36~B42

MDUNR/L



DN□□



• R type insert (mm)

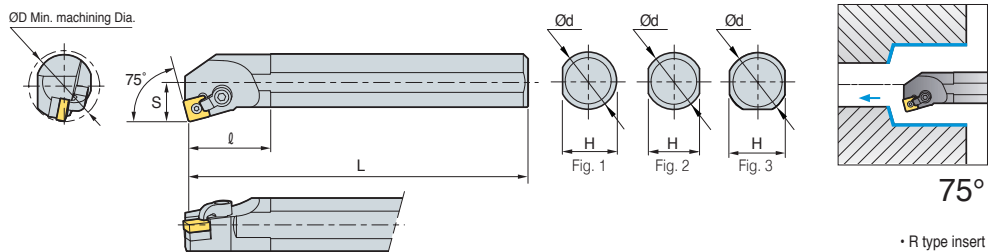
Designation	ØD	Ød	H	L	S	ℓ	Insert	Clamp	Clamp Screw	Shim	Shim Pin	Wrench	Fig.
S32S-MDUNR/L-15-3	40	32	30	250	22	50	DN□□1504□	CDH6N	DHA1/4-21	SD43D	SP4D	HW31.8L HW23.8L	3
S40T-MDUNR/L-15-3	50	40	38	300	27	60							
A32S-MDUNR/L-15-3	40	32	30	250	22	50							

➔ Applicable inserts B43~B48

MSKNR/L



SN□□



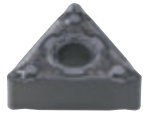
• R type insert (mm)

Designation	ØD	Ød	H	L	S	ℓ	Insert	Clamp	Clamp Screw	Shim	Shim Pin	Wrench	Fig.
S25R-MSKNR/L-12	32	25	23	200	17	40	SN□□1204□	CDH8N1	DHA5/16-28	SS43D	SP4D	HW39.7L HW23.8L	3
S32S-MSKNR/L-12	40	32	30	250	22	50							
S40T-MSKNR/L-12	50	40	38	300	27	60							
A25R-MSKNR/L-12	32	25	23	200	17	40	SN□□1204□	CDH8N1	DHA5/16-28	SS43D	SP4D	HW39.7L HW23.8L	1
A32S-MSKNR/L-12	40	32	30	250	22	50							3
A40T-MSKNR/L-12	50	40	38	300	27	60							

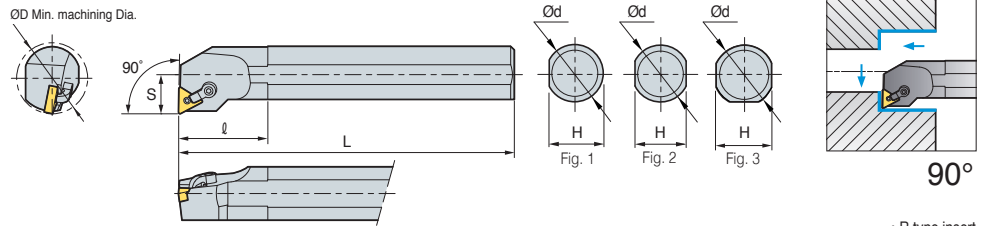
➔ Applicable inserts B50~B57



MTFNR/L



TN□□



• R type insert (mm)

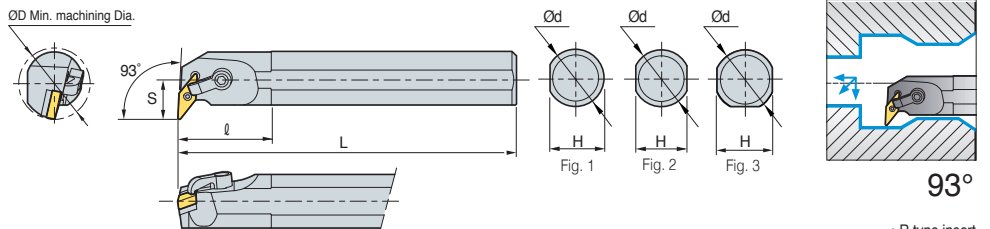
Designation	ØD	Ød	H	L	S	ℓ	Insert	Clamp	Clamp Screw	Shim	Shim Pin	Wrench	Fig.
S25R-MTFNR/L-16	32	25	23	200	17	40	TN□□1604□	CDH7N1	DHA10/32-19	-	SP3D3	HW23.8L	3
S32S-MTFNR/L-16	40	32	30	250	22	50							
S40T-MTFNR/L-16	50	40	38	300	27	60							
A25R-MTFNR/L-16	32	25	24	200	17	40	TN□□1604□	CDH7N1	DHA10/32-19	-	SP3D3	HW23.8L	1
A32S-MTFNR/L-16	40	32	30	250	22	50							

➔ Applicable inserts B58~B65

MVUNR/L



VN□□

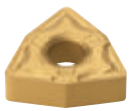


• R type insert (mm)

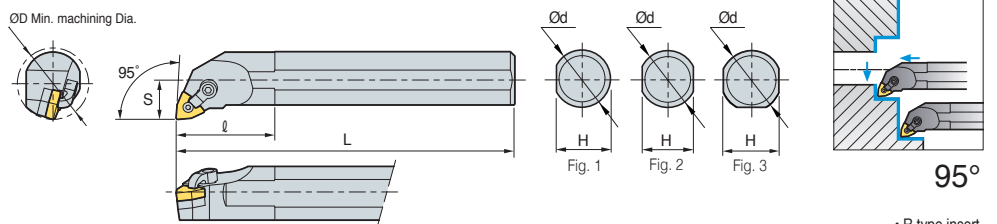
Designation	ØD	Ød	H	L	S	ℓ	Insert	Clamp	Clamp Screw	Shim	Shim Pin	Wrench	Fig.
S32S-MVUNR/L-16	40	32	30	250	22	50	VN□□1604□	CDH8N2	DHA5/16-28	SV32D	SP3D	HW39.7L	3
S40T-MVUNR/L-16	50	40	38	300	27	60							
A32S-MVUNR/L-16	40	32	30	250	22	50	VN□□1604□	CDH8N2	DHA5/16-28	SV32D	SP3D	HW39.7L	3
A40T-MVUNR/L-16	50	40	38	300	27	60							

➔ Applicable inserts B66~B67

MWLNR/L



WN□□



• R type insert (mm)

Designation	ØD	Ød	H	L	S	ℓ	Insert	Clamp	Clamp Screw	Shim	Shim Pin	Wrench	Fig.
S25R-MWLNR/L-06	32	25	23	200	17	40	WN□□0604□	CDH7N	DHA10/32-19	-	SP3D3	HW23.8L	3
S32S-MWLNR/L-06	40	32	30	250	22	50							
S40T-MWLNR/L-06	50	40	38	300	27	60							
S25R-MWLNR/L-08	32	25	23	200	17	40	WN□□0804□	CDH6N	DHA1/4-21	-	SP4DS	HW31.8L	3
S32S-MWLNR/L-08	40	32	30	250	22	50							
S40T-MWLNR/L-08	50	40	38	300	27	60							
A25R-MWLNR/L-06	32	25	24	200	17	40	WN□□0604□	CDH7N	DHA10/32-19	-	SP3D3	HW31.8L	1
A32S-MWLNR/L-06	40	32	31	250	22	50							
A25R-MWLNR/L-08	32	25	24	200	17	40	WN□□0804□	CDH6N	DHA1/4-21	-	SP4DS	HW31.8L	1
A32S-MWLNR/L-08	40	32	31	250	22	50							

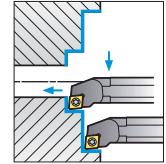
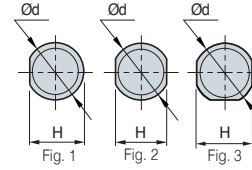
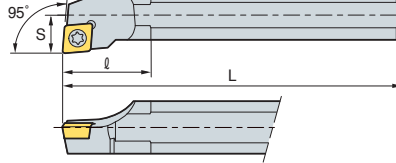
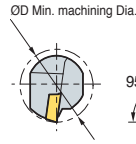
➔ Applicable inserts B68~B72



SCLCR/L



CC□T



95°

* R type insert (mm)

Steel shank type

Designation	ØD	Ød	H	L	S	ℓ	Insert	Screw	Shim	Shim Screw	Wrench	Fig.
S08K-SCLCR/L-06	11	8	7.2	125	6	12	CC□T0602□□	FTKA02555	-	-	TW07	2
S10K-SCLCR/L-06	13	10	9	125	6	16		FTKA02565	-	-	TW07P	
S10M-SCLCR/L-06	13	10	9	150	6	16						
S12M-SCLCR/L-06	16	12	11	150	9	20						
S16R-SCLCR/L-06	20	16	14	200	11	25						
S12M-SCLCR/L-09	16	12	11	150	9	20	CC□T09T3□□	FTGA03508	-	-	TW15P	2
S16R-SCLCR/L-09	20	16	14	200	11	25		FTGA03510	-	-	TW15P	3
S20S-SCLCR/L-09	25	20	18	250	13	32						
S25R-SCLCR/L-09	32	25	23	200	17	40	CC□T1204□□	FTGA0411F	SC42S	SHXN0610F	HW40L TW15P	3
S25R-SCLCR/L-12	32	25	23	200	17	40						
S32S-SCLCR/L-12	40	32	30	250	22	50						
S40T-SCLCR/L-12	50	40	38	300	27	60						
A08F-SCLCR/L-06	11	8	7.6	80	6	12	CC□T0602□□	FTKA02555	-	-	TW07P	1
A10H-SCLCR/L-06	13	10	9.5	100	7	16		FTKA02565	-	-	TW07P	
A12K-SCLCR/L-06	16	12	11.5	125	9	20	CC□T09T3□□					1
A12K-SCLCR/L-09	16	12	11.5	125	9	20		FTGA03508	-	-	TW15P	
A16M-SCLCR/L-09	20	16	15	150	11	25						
A20Q-SCLCR/L-09	25	20	19	180	13	32		FTGA03510	-	-	TW15P	
A25R-SCLCR/L-09	32	25	24	200	17	40						
A25R-SCLCR/L-12	32	25	24	200	17	40	CC□T1204□□	FTGA0411F	-	-	TW15P	1
A32S-SCLCR/L-12	40	32	31	250	22	50		FTGA0411F	SC42S	SHXN0610F	HW40L,TW15P	3

Carbide shank type

Designation	ØD	Ød	H	L	S	Insert	Screw	Wrench	Fig.
C04G-SCLCR/L-03	5	4	3.8	90	2.5	CC□T0301□□	FTNA01633	TW06P	1
C05H-SCLCR/L-03	6	5	4.4	100	3				
C06H-SCLCR/L-04	7	6	5.4	100	3.5		CC□T0401□□	FTNA0238	
C07K-SCLCR/L-04	8	7	6.4	125	4	CC□T0602□□	FTKA02555	TW07P	2
C08K-SCLCR/L-06	10	8	7	125	5				
C10K-SCLCR/L-06	12	10	9	125	6				
C10M-SCLCR/L-06	12	10	9	150	6				
C12M-SCLCR/L-06	14	12	11	150	9				
C12Q-SCLCR/L-06	14	12	11	180	9	CC□T09T3□□	FTGA03508	TW15P	2
C12M-SCLCR/L-09	15	12	11	150	8				
C12Q-SCLCR/L-09	15	12	11	180	8				
C16R-SCLCR/L-09	20	16	15	200	11				
C16S-SCLCR/L-09	20	16	15	250	11				
C20R-SCLCR/L-09	25	20	18	200	13	CC□T1204□□	FTGA0411F	TW15P	1
C20S-SCLCR/L-09	25	20	18	250	13				
C25T-SCLCR/L-12	32	25	23	300	17				
E06H-SCLCR/L-04	7	6	5.4	100	3.5	CC□T0401□□	FTNA0238	TW06P	1
E07K-SCLCR/L-04	8	7	6.4	125	4				
E08K-SCLCR/L-06	10	8	7	125	5	CC□T0602□□	FTKA02555	TW07P	2
E10K-SCLCR/L-06	12	10	9	125	6				
E10M-SCLCR/L-06	12	10	9	150	6				
E12M-SCLCR/L-06	14	12	11	150	9				
E12Q-SCLCR/L-06	14	12	11	180	9				
E12M-SCLCR/L-09	15	12	11	150	8	CC□T09T3□□	FTGA03508	TW15P	2
E12Q-SCLCR/L-09	15	12	11	180	8				
E16R-SCLCR/L-09	20	16	15	200	11				
E16S-SCLCR/L-09	20	16	15	250	11				
E20R-SCLCR/L-09	25	20	18	200	13				
E20S-SCLCR/L-09	25	20	19	250	13				
E25T-SCLCR/L-12	32	25	23	300	17	CC□T1204□□	FTGA0411F	TW15P	

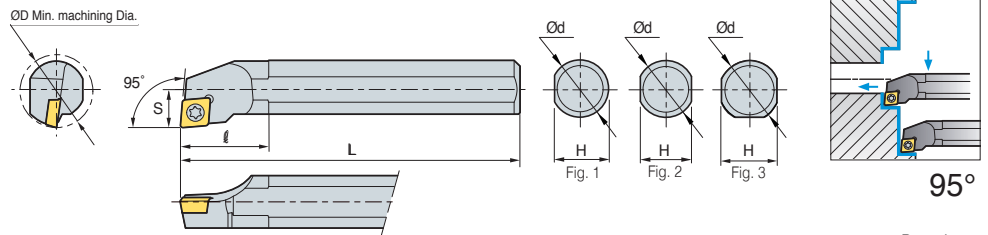
Applicable inserts B73~B77, B103



SCLPR/L



CP□T



• R type insert (mm)

Steel shank type

Designation	ØD	Ød	H	L	S	ℓ	Insert	Screw	Wrench	Fig.
S10M-SCLPR/L-08	13	10	9	150	7	16	CP□T0802□□	FTNA0305	TW09P	2
S12M-SCLPR/L-08	16	12	11	150	9	20		FTNA0307	TW09P	
S16N-SCLPR/L-09	20	16	14	160	11	25	CP□T0903□□	FTNA0408	TW15P	2
S16R-SCLPR/L-09	20	16	14	200	11	25				
S20N-SCLPR/L-09	25	20	18	160	13	32				
S20S-SCLPR/L-09	25	20	18	250	13	32				3
A10H-SCLPR/L-08	12	10	9.65	100	6	-	CP□T0802□□	FTNA0305	TW09P	1
A12K-SCLPR/L-08	16	12	11.5	125	9	20		FTNA0307	TW09P	
A16M-SCLPR/L-09	20	16	15.5	150	10	25	CP□T0903□□	FTNA0408	TW15P	1
A20Q-SCLPR/L-09	25	20	19	180	13	32				3

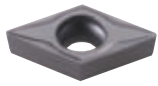
Carbide shank type

Designation	ØD	Ød	H	L	S	ℓ	Insert	Screw	Wrench	Fig.
C10K-SCLPR/L-08	12	10	9	125	6	14.5	CP□T0802□□	FTNA0305	TW09P	2
C10M-SCLPR/L-08	12	10	9	150	6	14.5				
C12M-SCLPR/L-08	15	12	11	150	7.5	14.7		FTNA0306	TW09P	
C12Q-SCLPR/L-08	15	12	11	180	7.5	14.7				
C12M-SCLPR/L-09	15	12	11	150	8	14.4	CP□T0903□□	FTNA0408	TW15P	2
C12Q-SCLPR/L-09	15	12	11	180	8	14.4				
C16R-SCLPR/L-09	20	16	15	200	10	22.4				
C16S-SCLPR/L-09	20	16	15	250	10	22.4				
C20R-SCLPR/L-09	25	20	18	200	13	22.5				
C20S-SCLPR/L-09	25	20	18	250	13	22.5				
E10K-SCLPR/L-08	12	10	9	125	6	14.5	CP□T0802□□	FTNA0305	TW09P	2
E10M-SCLPR/L-08	12	10	9	150	6	14.5				
E12M-SCLPR/L-08	15	12	11	150	7.5	14.7				
E12Q-SCLPR/L-08	15	12	11	180	7.5	14.7		FTNA0407	TW09P	
E12M-SCLPR/L-09	15	12	11	150	8	14.4				
E12Q-SCLPR/L-09	15	12	11	180	8	14.4				
E16R-SCLPR/L-09	20	16	15	200	10	22.4	CP□T0903□□	FTNA0408	TW15P	2
E16S-SCLPR/L-09	20	16	15	250	10	22.4				
E20R-SCLPR/L-09	25	20	18	200	13	22.5				
E20S-SCLPR/L-09	25	20	18	250	13	22.5				

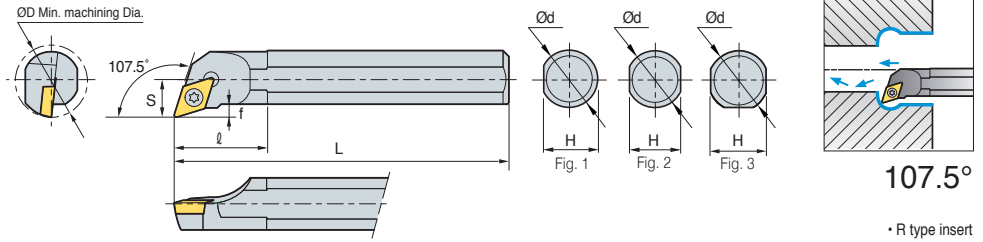
Applicable inserts B78



SDQCR/L



DC□T



Steel shank type

• R type insert (mm)

Designation	ØD	Ød	H	L	S	ℓ	Insert	Screw	Wrench	Fig.
S10M-SDQCR/L-07	13	10	9	150	7	16	DC□T0702□□	FTKA02555	TW07P	2
S12M-SDQCR/L-07	16	12	11	150	9	20		FTKA02565	TW07P	
S16R-SDQCR/L-07	20	16	14	200	11	25				
S16R-SDQCR/L-11	20	16	14	200	11	25	DC□T11T3□□	FTGA03508	TW15P	2
S20S-SDQCR/L-11	25	20	18	250	13	32		FTGA03510	TW15P	
S25R-SDQCR/L-11	32	25	23	200	17	40				
A10H-SDQCR/L-07	13	10	9.5	100	7	16	DC□T0702□□	FTKA02555	TW07P	1
A12K-SDQCR/L-07	16	12	11.5	125	9	20		FTKA02565	TW07P	1
A16M-SDQCR/L-11	20	16	15	150	11	25	DC□T11T3□□	FTGA03508	TW15P	1
A20Q-SDQCR/L-11	25	20	19	180	13	32		FTGA03510	TW15P	
A25R-SDQCR/L-11	32	25	24	200	17	40				

Carbide shank type

(mm)

Designation	ØD	Ød	H	L	S	ℓ	Insert	Screw	Wrench	Fig.
C08K-SDQCR/L-07	10	8	7	125	6	-	DC□T0702□□	FTKA02555	TW07P	2
C10K-SDQCR/L-07	13	10	9	125	7	14.0		FTKA02565	TW07P	
C12M-SDQCR/L-07	16	12	11	150	9	14.0				
C16R-SDQCR/L-07	20	16	15	200	11	-				
C16R-SDQCR/L-11	20	16	15	200	11	21.3	DC□T11T3□□	FTGA03508	TW15P	2
C20R-SDQCR/L-11	25	20	18	200	13	24.0				
C20S-SDQCR/L-11	25	20	18	250	13	24.0				
E08K-SDQCR/L-07	10	8	7	125	6	-	DC□T0702□□	FTKA02555	TW07P	2
E10K-SDQCR/L-07	13	10	9	125	7	14.0		FTKA02565	TW07P	
E12M-SDQCR/L-07	16	12	11	150	9	14.0				
E16R-SDQCR/L-07	20	16	15	200	11	-				
E16R-SDQCR/L-11	20	16	15	200	11	21.3	DC□T11T3□□	FTGA03508	TW15P	2
E20R-SDQCR/L-11	25	20	18	200	13	24.0				
E20S-SDQCR/L-11	25	20	19	250	13	24.0				

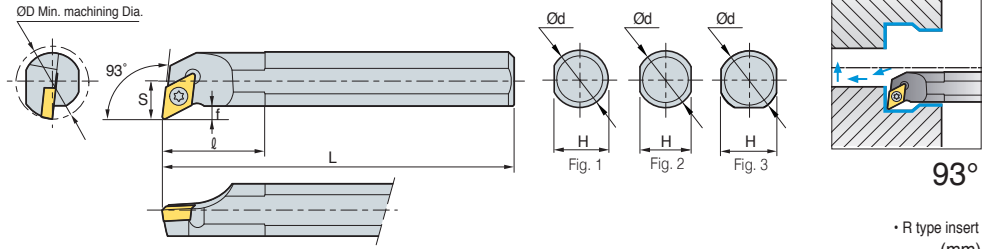
Applicable inserts B79~B82, B103



SDUCR/L



DC□T



Steel shank type

Designation	ØD	Ød	H	L	S	ℓ	Insert	Screw	Wrench	Fig.
S10M-SDUCR/L-07	13	10	9	150	7	16	DC□T0702□□	FTKA02555	TW07P	2
S12M-SDUCR/L-07	16	12	11	150	9	20		FTKA02565	TW07P	2
S16R-SDUCR/L-07	20	16	14	200	11	25				
S16R-SDUCR/L-11	20	16	14	200	11	25	DC□T11T3□□	FTGA03508	TW15P	2
S20S-SDUCR/L-11	25	20	18	250	13	32		FTGA03510	TW15P	3
S25R-SDUCR/L-11	32	25	23	200	17	40				
S32S-SDUCR/L-11	40	32	30	250	22	50				
A10H-SDUCR/L-07	13	10	9.5	100	7	16	DC□T0702□□	FTKA02555	TW07P	1
A12K-SDUCR/L-07	16	12	11.5	125	9	20		FTKA02565	TW07P	1
A16M-SDUCR/L-07	20	16	15	150	11	25				
A20Q-SDUCR/L-11	25	20	19	180	13	32	DC□T11T3□□	FTGA03508	TW15P	1
A25R-SDUCR/L-11	32	25	24	200	17	40		FTGA03510	TW15P	

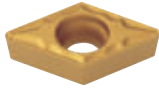
Carbide shank type

Designation	ØD	Ød	H	L	S	ℓ	Insert	Screw	Wrench	Fig.	
C10K-SDUCR/L-07	13	10	9	125	7	9.8	DC□T0702□□	FTKA02555	TW07P	2	
C10M-SDUCR/L-07	13	10	9	150	7	9.8					FTKA02565
C12M-SDUCR/L-07	16	12	11	150	9	11.0		DC□T11T3□□	FTGA03508		
C12Q-SDUCR/L-07	16	12	11	180	9	11.0					FTGA03510
C16R-SDUCR/L-07	20	16	15	200	11	-	DC□T0702□□	FTKA02555	TW07P	2	
C16S-SDUCR/L-07	20	16	15	250	11	-					FTKA02565
C16R-SDUCR/L-11	20	16	15	200	11	-		DC□T11T3□□	FTGA03508		
C16S-SDUCR/L-11	20	16	15	250	11	-					FTGA03510
C20R-SDUCR/L-11	25	20	18	200	13	-	DC□T0702□□	FTKA02555	TW07P	2	
C20S-SDUCR/L-11	25	20	18	250	13	-					FTKA02565
C25T-SDUCR/L-11	32	25	23	300	17	-		DC□T11T3□□	FTGA03508		
E10K-SDUCR/L-07	13	10	9	125	7	9.8					FTGA03510
E10M-SDUCR/L-07	13	10	9	150	7	9.8	DC□T0702□□	FTKA02555	TW07P	2	
E12M-SDUCR/L-07	16	12	11	150	9	11.0					FTKA02565
E12Q-SDUCR/L-07	16	12	11	180	9	11.0		DC□T11T3□□	FTGA03508		
E16R-SDUCR/L-07	20	16	15	200	11	-					FTGA03510
E16S-SDUCR/L-07	20	16	15	250	11	-	DC□T0702□□	FTKA02555	TW07P	2	
E16R-SDUCR/L-11	20	16	15	200	11	-					FTKA02565
E16S-SDUCR/L-11	20	16	15	250	11	-		DC□T11T3□□	FTGA03508		
E20R-SDUCR/L-11	25	20	18	200	13	-					FTGA03510
E20S-SDUCR/L-11	25	20	18	250	13	-	DC□T0702□□	FTKA02555	TW07P	2	
E25T-SDUCR/L-11	32	25	23	300	17	-					FTKA02565
							DC□T11T3□□	FTGA03508	TW15P		
											FTGA03510

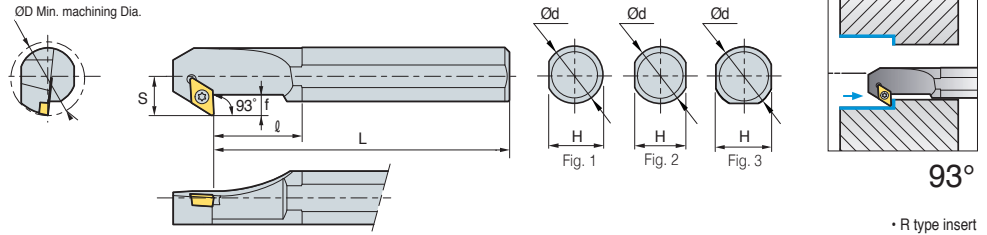
Applicable inserts B79~B82, B104



SDZCR/L



DC□T



93°

• R type insert (mm)

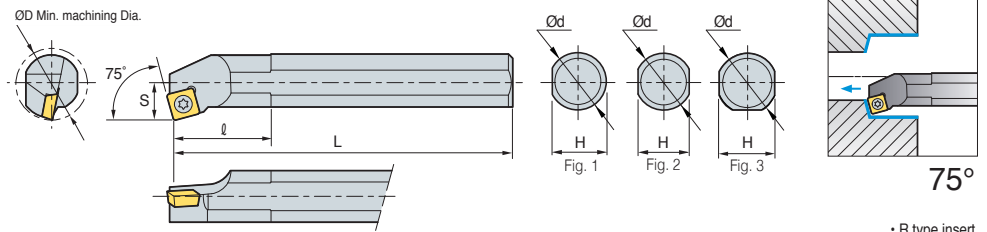
Designation	ØD	Ød	H	L	S	ℓ	f	Insert	Screw	Shim	Shim Screw	Wrench	Fig.
S16R-SDZCR/L-07	20	16	14	200	11	25	6.5	DC□T0702□□	FTKA02565	-	-	TW07P	2
S20S-SDZCR/L-07	25	20	18	250	13	32	7.5						
S25R-SDZCR/L-11	32	25	23	200	17	40	9	DC□T11T3□□	FTGA03510	-	-	TW15P	3
S32S-SDZCR/L-11	40	32	30	250	22	50	11		FTGA03512	SD32S	SHXN0509F	TW15P, HW35L	
S40T-SDZCR/L-11	50	40	38	300	27	60	11		FTGA03510	-	-	TW15P	1
A25R-SDZCR/L-11	32	25	24	200	17	40	9		FTGA03512	SD32S	SHXN0509F	TW15P, HW35L	3

↻ Applicable inserts B79~B82, B104

SSKCR/L



SC□T



75°

• R type insert (mm)

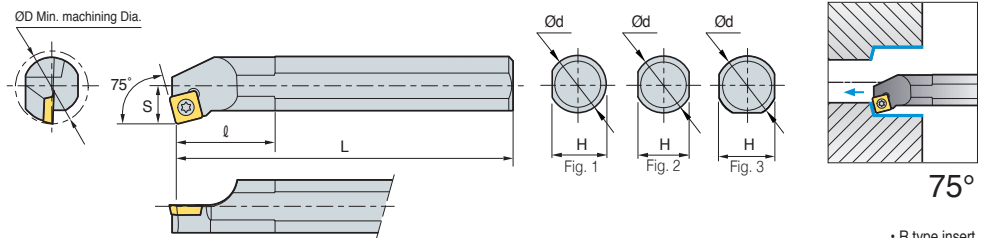
Designation	ØD	Ød	H	L	S	ℓ	Insert	Screw	Shim	Shim Screw	Wrench	Fig.
S12M-SSKCR/L-09	16	12	11	150	9	20	SC□T09T3□□	FTGA03507	-	-	TW15P	2
S16R-SSKCR/L-09	20	16	14	200	11	25		FTGA03508	-	-	TW15P	
S20S-SSKCR/L-09	25	20	18	250	13	32	SC□T1204□□	FTGA0411F	-	-	TW15P	3
S25R-SSKCR/L-12	32	25	23	200	17	40		FTGA0411F	SS42S	SHXN0610F	TW15P, HW40L	
S32S-SSKCR/L-12	40	32	30	250	22	50	FTGA03507	-	-	TW15P	1	
A12K-SSKCR/L-09	16	12	11.5	125	9	20	FTGA03508	-	-	TW15P		
A16M-SSKCR/L-09	20	16	15	150	11	25	SC□T1204□□	FTGA0411F	-	-	TW15P	3
A20Q-SSKCR/L-09	25	20	19	180	13	32		FTGA0411F	SS42S	SFXN0610F	TW15P, HW40L	

↻ Applicable inserts B84, B106

SSKPR/L



SP□T



75°

• R type insert (mm)

Designation	ØD	Ød	H	L	S	ℓ	Insert	Screw	Wrench	Fig.
S12M-SSKPR/L-09	16	12	11	150	9	20	SP□T09T3□□	FTNA0307	TW09P	2
S16N-SSKPR/L-09	20	16	14	160	11	25				
S16R-SSKPR/L-09	20	16	14	200	11	25				
S20N-SSKPR/L-09	25	20	18	160	13	32				
S20S-SSKPR/L-09	25	20	18	250	13	32				
A12K-SSKPR/L-09	16	12	11.5	125	9	20	SP□T09T3□□	FTNA0307	TW09P	1
A16M-SSKPR/L-09	20	16	15	150	11	25				
A20Q-SSKPR/L-09	25	20	19	180	13	32				

↻ Applicable inserts B85~B86

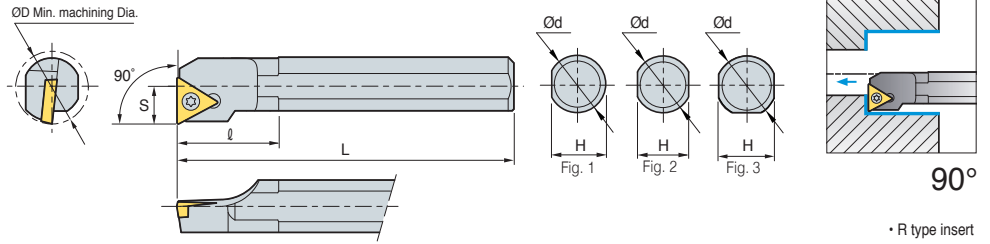
• Use left handed insert for right handed holder



STFCR/L



TC□T



Steel shank type

Designation	ØD	Ød	H	L	S	ℓ	Insert	Screw	Shim	Shim Screw	Wrench	Fig.
S10M-STFCR/L-09	13	10	9	150	7	16	TC□T0902□□	FTKA02206	-	-	TW06P	2
S12M-STFCR/L-09	16	12	11	150	9	20						
S12M-STFCR/L-11	16	12	11	150	9	20	TC□T1102□□	FTKA02565	-	-	TW07P	2
S16R-STFCR/L-11	20	16	14	200	11	25						
S20S-STFCR/L-11	25	20	18	250	13	32	TC□T16T3□□	FTGA03510	-	-	TW15P	2
S20S-STFCR/L-16	25	20	18	250	13	32						3
S25R-STFCR/L-16	32	25	23	200	17	40	TC□T16T3□□	FTGA03512	ST32S	SHXN0509F	TW15P, HW35L	3
S32S-STFCR/L-16	40	32	30	250	22	50						
S40T-STFCR/L-16	50	40	38	300	27	60	TC□T0902□□	FTKA02206	-	-	TW06P	1
A10H-STFCR/L-09	13	10	9.5	100	7	16						
A12K-STFCR/L-09	16	12	11.5	125	9	20	TC□T1102□□	FTKA02565	-	-	TW07P	1
A12K-STFCR/L-11	16	12	11.5	125	9	20						
A16M-STFCR/L-11	20	16	15	150	11	25	TC□T16T3□□	FTKA03510	-	-	TW15P	1
A20Q-STFCR/L-11	25	20	19	180	13	32						
A25R-STFCR/L-16	32	25	24	200	17	40	TC□T16T3□□	FTGA03512	ST32S	SHXN0509F	TW15P, HW35L	3
A32S-STFCR/L-16	40	32	30	250	22	50						

Carbide shank type

Designation	ØD	Ød	H	L	S	ℓ	Insert	Screw	Wrench	Fig.
C08K-STFCR/L-09	10	8	7	125	5	-	TC□T0902□□	FTKA02206	TW06P	2
C10K-STFCR/L-09	12	10	9	125	6	14.0				
C10K-STFCR/L-11	12	10	9	125	6	12.5	TC□T1102□□	FTKA02565	TW07P	2
C12M-STFCR/L-11	15	12	11	150	8	-				
C16R-STFCR/L-11	20	16	15	200	10	-				
C20R-STFCR/L-11	25	20	18	200	13	23.0				
C20S-STFCR/L-11	25	20	18	250	13	23.0	TC□T16T3□□	FTGA03510	TW15P	2
C20R-STFCR/L-16	25	20	18	200	13	-				
C20S-STFCR/L-16	25	20	18	250	13	-	TC□T0902□□	FTKA02206	TW06P	2
E08K-STFCR/L-09	10	8	7	125	5	-				
E10K-STFCR/L-09	12	10	9	125	6	14.0	TC□T1102□□	FTKA02565	TW07P	2
E10K-STFCR/L-11	12	10	9	125	6	12.5				
E12M-STFCR/L-11	15	12	11	150	8	-				
E16R-STFCR/L-11	20	16	15	200	11	-				
E20R-STFCR/L-11	25	20	18	200	13	23.0	TC□T16T3□□	FTGA03510	TW15P	2
E20S-STFCR/L-11	25	20	18	250	13	23.0				
E20R-STFCR/L-16	25	20	18	200	13	-	TC□T16T3□□	FTGA03510	TW15P	2
E20S-STFCR/L-16	25	20	19	250	13	-				

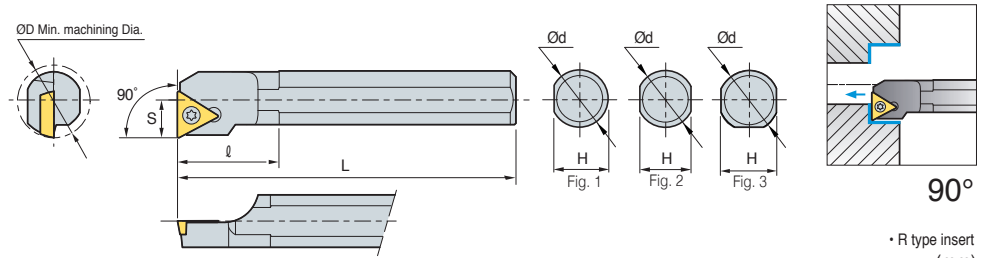
Applicable inserts B88~B89, B107



STFPR/L



TP□T



Steel shank type

Designation	ØD	Ød	H	L	S	ℓ	Insert	Screw	Wrench	Fig.
S10M-STFPR/L-11	13	10	9	150	7	16	TP□T1103□□	FTNA0306	TW09P	2
S12M-STFPR/L-11	16	12	11	150	9	20		FTNA0307	TW09P	2
S16N-STFPR/L-11	20	16	14	160	11	25				
S16R-STFPR/L-11	20	16	14	200	11	25				
S20N-STFPR/L-16	25	20	18	160	13	32	TP□T1604□□	FTNA0408	TW15P	2
S20S-STFPR/L-16	25	20	18	250	13	32				
A10H-STFPR/L-11	13	10	9.5	100	7	16	TP□T1103□□	FTNA0306	TW09P	1
A12K-STFPR/L-11	16	12	11	125	9	20		FTNA0307	TW09P	1
A16M-STFPR/L-11	20	16	15	150	11	25				
A20Q-STFPR/L-16	25	20	19	180	13	32	TP□T1604□□	FTNA0408	TW15P	1

Carbide shank type

Designation	ØD	Ød	H	L	S	ℓ	Insert	Screw	Wrench	Fig.
C08K-STFPR/L-08	10	8	7	125	5	13.7	TP□T1103□□	FTNA02205	TW06P	2
C10K-STFPR/L-11	12	10	9	125	6	14.0		FTNA0305	TW09P	
C10M-STFPR/L-11	12	10	9	150	6	14.0				
C12M-STFPR/L-11	15	12	11	150	8	-				
C12Q-STFPR/L-11	15	12	11	180	8	-				
C16R-STFPR/L-11	20	16	15	200	10	-				
C16S-STFPR/L-11	20	16	15	250	10	-				
C20R-STFPR/L-11	25	20	18	200	13	-				
C20S-STFPR/L-11	25	20	18	250	13	-				
C20R-STFPR/L-16	25	20	18	200	13	-				
C20S-STFPR/L-16	25	20	18	250	13	-	TP□T1604□□	FTNA0408	TW15P	
C25T-STFPR/L-16	32	25	23	300	17	23.5				
E08K-STFPR/L-08	10	8	7	125	5	13.7	TP□T1103□□	FTNA02205	TW06P	2
E10K-STFPR/L-11	12	10	9	125	6	14.0		FTNA0305	TW09P	
E10M-STFPR/L-11	12	10	9	150	6	14.0				
E12M-STFPR/L-11	15	12	11	150	8	-				
E12Q-STFPR/L-11	15	12	11	180	8	-				
E16R-STFPR/L-11	20	16	15	200	10	-				
E16S-STFPR/L-11	20	16	15	250	10	-				
E20R-STFPR/L-11	25	20	18	200	13	-				
E20S-STFPR/L-11	25	20	18	250	13	-				
E20R-STFPR/L-16	25	20	18	200	13	-				
E20S-STFPR/L-16	25	20	18	250	13	-	TP□T1604□□	FTNA0408	TW15P	
E25T-STFPR/L-16	32	25	23	300	17	23.5				

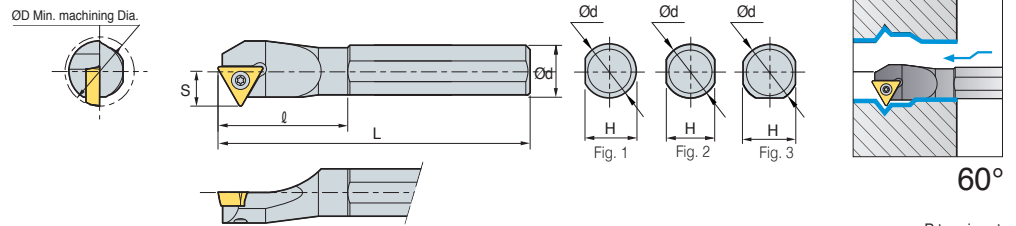
Applicable inserts B90~B93

Use left handed insert for right handed holder

STWPR/L



TP□□



60°

• R type insert (mm)

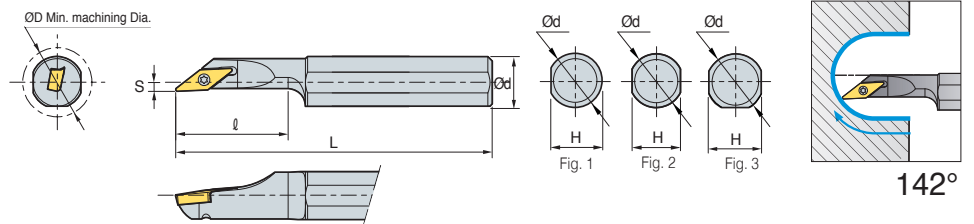
Designation	ØD	Ød	H	L	S	ℓ	Insert	Screw	Wrench	Fig.
S10M-STWPR/L-11	13	10	7	150	7	16	TPGH1102□□	FTNA0305	TW09P	2
S12M-STWPR/L-11	16	12	9	150	9	20	TPGH1103□□	FTNA0306	TW09P	
S16Q-STWPR/L-11	20	16	14	180	11	25	TPMT1103□□			
S20R-STWPR/L-11	25	20	18	200	13	32				

➔ Applicable inserts B90~B93

SVJCR/L



VC□□



142°

• R type insert (mm)

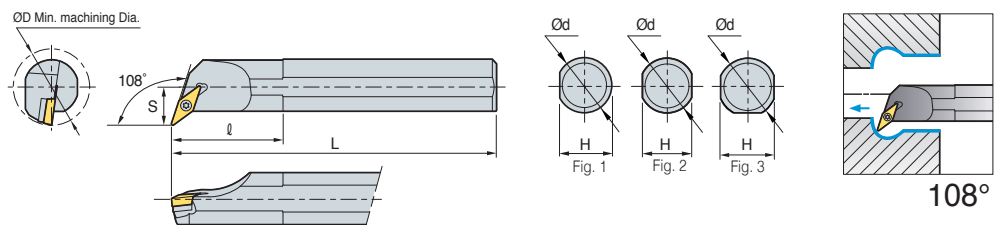
Designation	ØD	Ød	H	L	S	ℓ	Insert	Screw	Wrench	Fig.
S12M-SVJCR/L-08	16	12	11	150	2	26	VCMT0802□□	FTNA0204	TW06P	2
S16Q-SVJCR/L-08	20	16	15	180	2	36				

➔ Applicable inserts B97~B99, B109

SVQBR/L



VB□T



108°

• R type insert (mm)

Designation	ØD	Ød	H	L	S	ℓ	Insert	Screw	Shim	Shim Screw	Wrench	Fig.
S32S-SVQBR/L-16	40	32	30	250	22	50	VB□T1604□□	FTGA03512	SV32S	SHXN0509F	TW15P HW35L	3
S40T-SVQBR/L-16	50	40	38	300	27	60						
A32S-SVQBR/L-16	40	32	30	250	22	50						

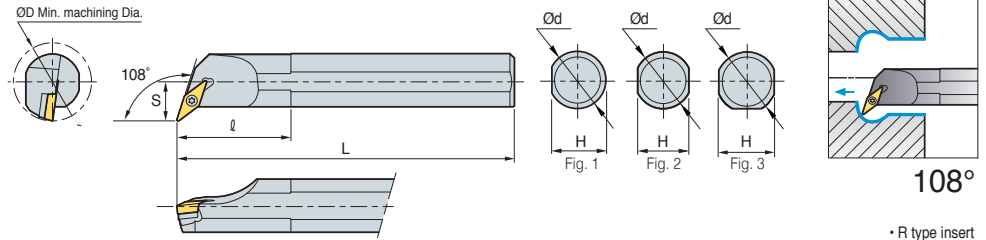
➔ Applicable inserts B94~B96, B108



SVQCR/L



VC□T



• R type insert (mm)

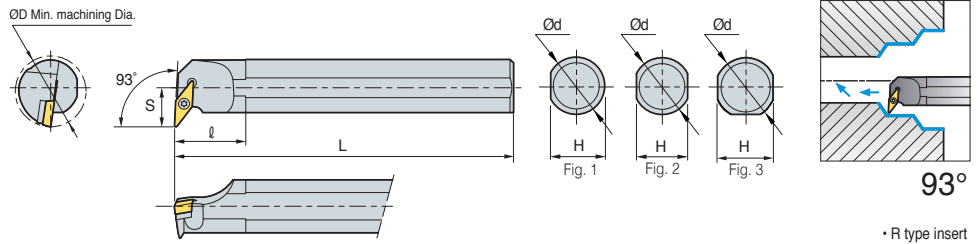
Designation	ØD	Ød	H	L	S	ℓ	Insert	Screw	Shim	Shim Screw	Wrench	Fig.
S16R-SVQCR/L-11	20	16	14	200	11	25	VC□T1103□□	FTKA02565	-	-	TW07P	2
S20S-SVQCR/L-11	25	20	18	250	13	32						3
S25R-SVQCR/L-11	32	25	23	200	17	40	VC□T1303□□	FTKA0307	-	-	TW07P	2
S20S-SVQCR/L-13	25	20	18	250	13	32						3
S25R-SVQCR/L-13	32	25	23	200	17	40	VC□T1604□□	FTGA03510	-	-	TW15P	3
S25R-SVQCR/L-16	32	25	23	200	17	40		FTGA03512	SV32S	SHXN0509F	TW15P HW35L	
S32S-SVQCR/L-16	40	32	30	250	22	50						
S40T-SVQCR/L-16	50	40	38	300	27	60						

↻ Applicable inserts B97~B99, B109

SVUBR/L



VB□T



• R type insert (mm)

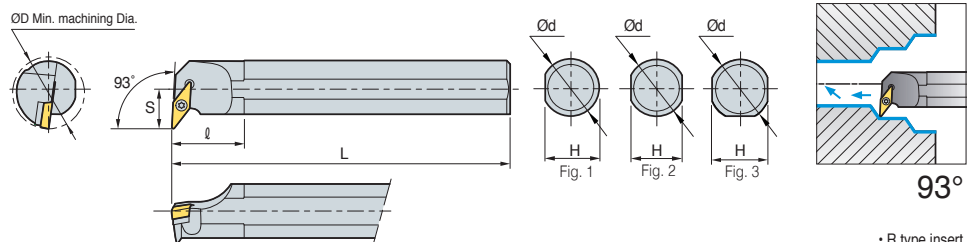
Designation	ØD	Ød	H	L	S	ℓ	Insert	Screw	Shim	Shim Screw	Wrench	Fig.
S32S-SVUBR/L-16	40	32	30	250	22	50	VB□T1604□□	FTGA03512	SV32S	SHXN0509F	TW15P HW35L	3
S40T-SVUBR/L-16	50	40	38	300	27	60						
A32S-SVUBR/L-16	40	32	30	250	22	50						

↻ Applicable inserts B94~B96, B108

SVUCR/L



VC□T



• R type insert (mm)

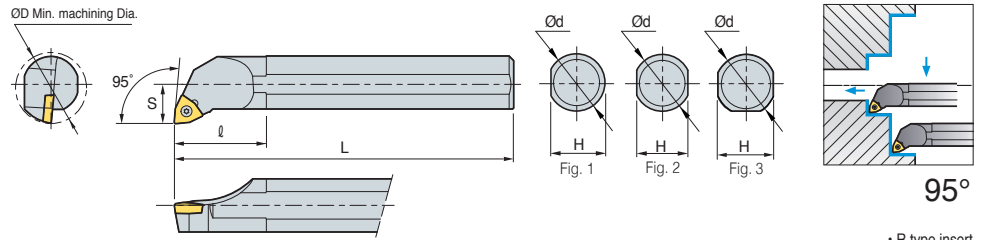
Designation	ØD	Ød	H	L	S	ℓ	Insert	Screw	Shim	Shim Screw	Wrench	Fig.
S16R-SVUCR/L-11	22	16	14	200	13	25	VC□T1103□□	FTKA02565	-	-	TW07P	2
S20S-SVUCR/L-11	25	20	18	250	13	32						3
S25T-SVUCR/L-11	32	25	23	300	17	40	VC□T1303□□	FTKA0307	-	-	TW09P	2
S20S-SVUCR/L-13	25	20	18	250	13	32						3
S25R-SVUCR/L-13	32	25	23	200	17	40	VC□T1604□□	FTGA03510	-	-	TW15P	3
S25R-SVUCR/L-16	32	25	23	200	17	40		FTGA03512	SV32S	SHXN0509F	TW15P HW35L	
S32S-SVUCR/L-16	40	32	30	250	22	50						
S40T-SVUCR/L-16	50	40	38	300	27	60						

↻ Applicable inserts B97~B99, B109

SWLCR/L



WC□T



• R type insert (mm)

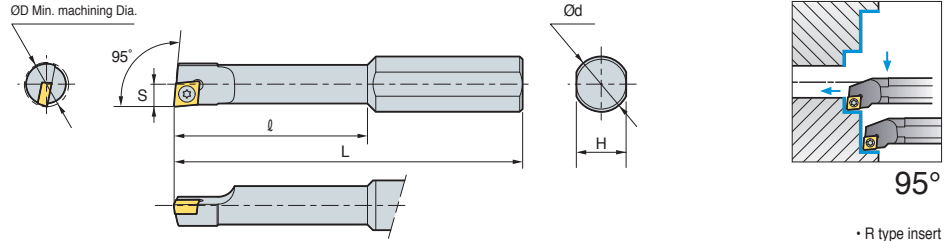
Designation	ØD	Ød	H	L	S	ℓ	Insert	Screw	Wrench	Fig.
S25R-SWLCR/L-08	32	25	23	200	17	40	WC□T0804□□	FTGA0411F	TW15P	3
S32S-SWLCR/L-08	40	32	30	250	22	50				
A25R-SWLCR/L-08	32	25	24	200	17	40	WC□T0804□□	FTGA0411F	TW15P	1
A32S-SWLCR/L-08	40	32	30	250	22	50				3



SCLCR/L



CCET



• R type insert (mm)

Designation	ØD	Ød	H	L	S	l	Insert	Screw	Wrench
S10H-SCLCR/L-0305	5	10	9	100	2.5	25	CCET0301□□	FTNA01633	TW06P
S10H-SCLCR/L-0306	6	10	9	100	3.0	25			
S10J-SCLCR/L-0407	7	10	9	110	3.5	30	CCET0401□□	FTNA0238	TW06P
S10J-SCLCR/L-0408	8	10	9	110	4.0	30			

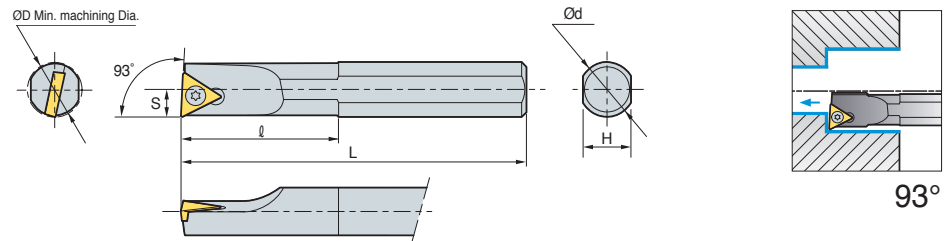
➔ Applicable inserts B73 ~B77, B103

• Use left handed insert for right handed holder

STUBR/L



TB□□



• R type insert (mm)

➔ Steel shank type

Designation	ØD	Ød	H	L	S	l	Insert	Screw	Wrench
S08K-STUBR/L-06	8	8	7	125	4	30	TB□□0601□□R/L	FTNA0204	TW06P
A08F-STUBR/L-06	8	8	7.5	80	4	30			

➔ Carbide shank type

Designation	ØD	Ød	H	L	S	l	Insert	Screw	Wrench
C08K-STUBR/L-06	10	8	7	125	5		TB□T0601□□	FTNA0204	TW06P
C10K-STUBR/L-06	12	10	9	125	6				
E08K-STUBR/L-06	10	8	7	125	5		TB□T0601□□	FTNA0204	TW06P
E10K-STUBR/L-06	12	10	9	125	6				

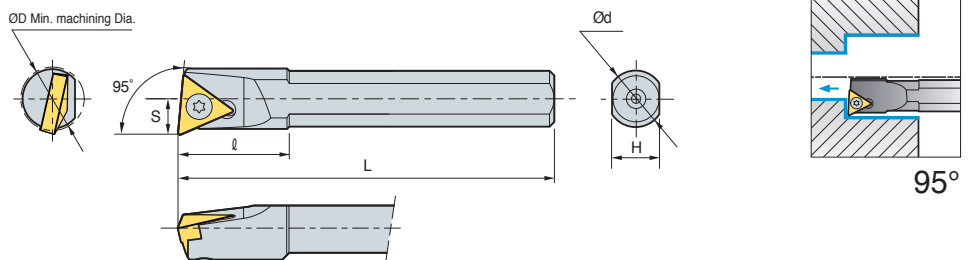
➔ Applicable inserts B87

• Use left handed insert for right handed holder

STLBR/L



TB□□



• R type insert (mm)

➔ Steel shank type

Designation	ØD	Ød	H	L	S	l	Insert	Screw	Wrench
S06H-STLBR/L-06-SP	8	6	5	100	3.8	12	TB□□0601□□R/L	FTNA0204	TW06P

➔ Applicable inserts B87

• Use left handed insert for right handed holder

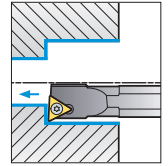
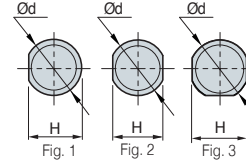
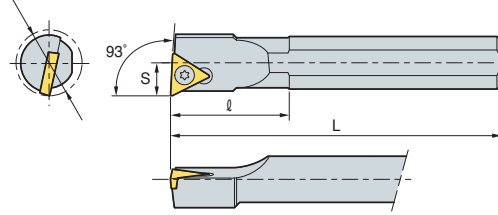


STUPR/L



TP□□

OD Min. machining Dia.



93°

Steel shank type

• R type insert (mm)

Designation	ØD	Ød	H	L	S	l	Insert	Screw	Wrench	Fig.
S08K-STUPR/L-08	10	8	7	125	4	18	TP□□0802□□R/L	FTNA02205	TW06P	2
A08F-STUPR/L-08	10	8	7.5	80	5	18				

Carbide shank type

(mm)

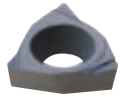
Designation	ØD	Ød	H	L	S	l	Insert	Screw	Wrench	Fig.
C08K-STUPR/L-08	10	8	7	125	5		TP□T0802□□	FTNA02205	TW06P	2
C10K-STUPR/L-11	12	10	9	125	6		TP□T1103□□	FTNA0305	TW09P	
C10M-STUPR/L-11	12	10	9	150	6					
C12M-STUPR/L-11	15	12	11	150	8					
C12Q-STUPR/L-11	15	12	11	180	8					
C16R-STUPR/L-11	20	16	15	200	10					
C16S-STUPR/L-11	20	16	15	250	10					
C20R-STUPR/L-11	25	20	18	200	13		TP□T1604□□	FTNA0408	TW15P	
C20S-STUPR/L-11	25	20	18	250	13					
C20R-STUPR/L-16	25	20	18	200	13					
C20S-STUPR/L-16	25	20	18	250	13					
C25T-STUPR/L-16	32	25	23	300	17					
E08K-STUPR/L-08	10	8	7	125	5		TP□T0802□□	FTNA02205	TW06P	2
E10K-STUPR/L-11	12	10	9	125	6		TP□T1103□□	FTNA0305	TW09P	
E10M-STUPR/L-11	12	10	9	150	6					
E12M-STUPR/L-11	15	12	11	150	8					
E12Q-STUPR/L-11	15	12	11	180	8					
E16R-STUPR/L-11	20	16	15	200	10					
E16S-STUPR/L-11	20	16	15	250	10					
E20R-STUPR/L-11	25	20	18	200	13		TP□T1604□□	FTNA0408	TW15P	
E20S-STUPR/L-11	25	20	18	250	13					
E20R-STUPR/L-16	25	20	18	200	13					
E20S-STUPR/L-16	25	20	18	250	13					
E25T-STUPR/L-16	32	25	23	300	17					

Applicable inserts B90~B93

• Use left handed insert for right handed holder

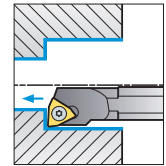
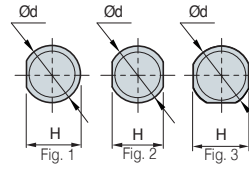
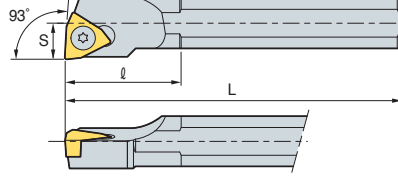
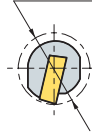


SWUBR/L



WB□T

ØD Min. machining Dia.



93°

Steel shank type

• R type insert (mm)

Designation	ØD	Ød	H	L	S	ℓ	Insert	Screw	Wrench	Fig.
S05H-SWUBR/L-02	5.5	5	4.5	100	2.75	-	WBGTO201□□R/L	FTNA0203	TW06P	2
S08K-SWUBR/L-02	8	8	7	125	4	30		FTNA02033		
S08K-SWUBR/L-S3	10	8	7	125	5	18	WBGTS302□□R/L	FTNA02205		
A08F-SWUBR/L-02	8	8	7.5	80	4	30	WBGTO201□□R/L	FTNA0203		
A08F-SWUBR/L-S3	10	8	7.5	80	5	16	WBGTS302□□R/L	FTNA02205		

Carbide shank type

(mm)

Designation	ØD	Ød	H	L	S	ℓ	Insert	Screw	Wrench	Fig.
C05H-SWUBR/L-02	6	5	4.4	100	3	-	WB□T0201□□	FTNA0203	TW06P	1
C06H-SWUBR/L-02	7	6	5.4	100	3.5	-		FTNA02033	TW06P	2
C08K-SWUBR/L-02	9	8	7	125	4.5	-	WB□TS301□□	FTNA02205	TW06P	
C08K-SWUBR/L-S3	10	8	7	125	4.5	-		FTNA02205	TW06P	
E06H-SWUBR/L-02	7	6	5.4	100	3.5	-	WB□T0201□□	FTNA0203	TW06P	2
E08K-SWUBR/L-02	9	8	7	125	4.5	-		FTNA02033	TW06P	
E08K-SWUBR/L-S3	10	8	7	125	5	-	WB□TS301□□	FTNA02205	TW06P	

↻ Applicable inserts **B101**

• Use left handed insert for right handed holder



※ See page B151 for applicable sleeves

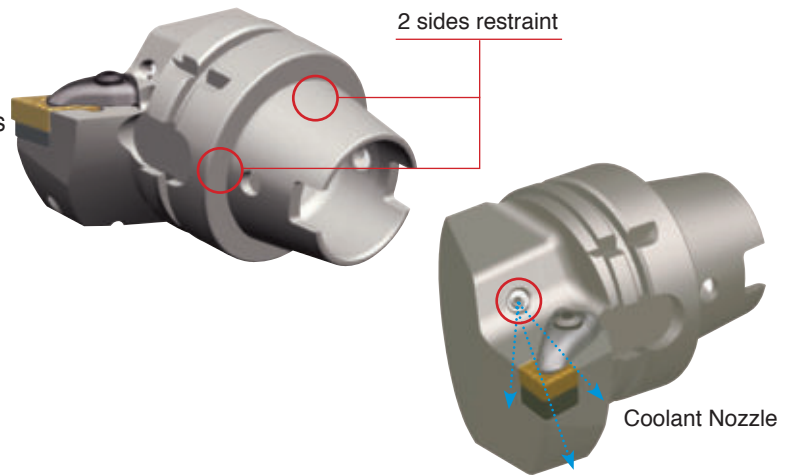


B Technical Information for HSK Tooling System

2 sides restraint - side and taper part

HSK Tooling System [For Multi-task Machines]

- 2 sides restraint - side and taper part
- Toughness guaranteed for static and dynamic movements
- Precision guaranteed on shaft and repeat directions
- Suitable at high speeds
- Suitable for small work pieces
- Coolant Nozzle is easily adjustable



Code system

C: 80° Diamond D: 55° Diamond
S: 90° Square T: 60° Triangle
V: 35° Diamond W: 80° Hexagon

N = 0°
B = 5°

DX: 65
H: 100
L: 140

Insert Shape

Clearance angle of insert

Length of tool holder



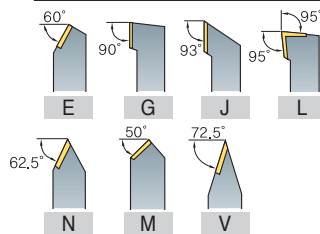
Taper design & size

ICTM = HSK standard

Clamping Type

D: Double Clamp
M: Multi Clamp
P: Lever Lock
S: Screw On
W: Wedge Clamp

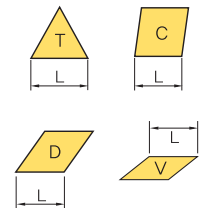
Holder Style



Hand

R: Right
L: Left
N: No Hand

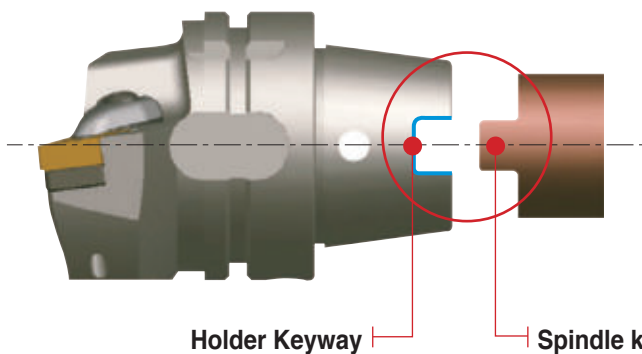
Cutting edge Length



ICTM (Interface committee for turning mill)

• Interface for Multi-task machines turning tool, which is tooling system based on ICTM standard from 17 major Japanese companies cooperation and is compatible with conventional HSK-A type and common to Multi-task machines and machining centers

Tolerance of keyway has been improved: HSK-T63



Tolerance comparison (Example)

(mm)

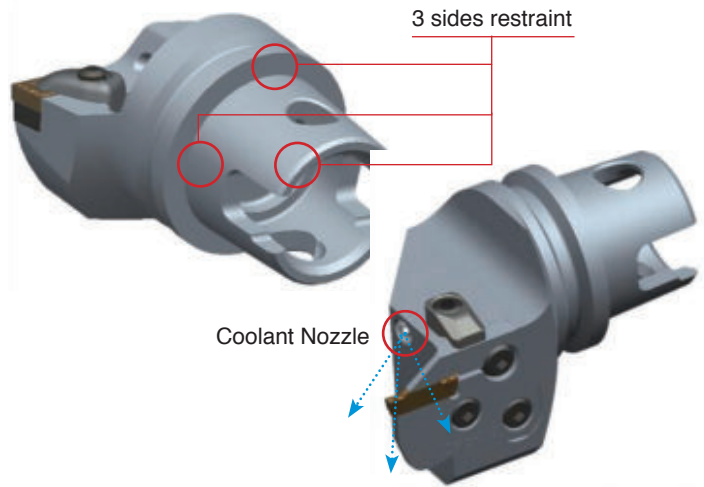
Remarks	Maximum Tolerance	Minimum Tolerance
ICTM STANDARD HSK-T63	0.075	0.035
ISO STANDARD HSK-A63	0.33	0.08



3 Face Binding - Superior precision

KM Tooling System [For Multi-task Machines]

- 3 Face binding/Superior precision
- Flexible clamping system/Superior rigidity
- Various size & style
- Appropriate for turning & milling
- Adjustable coolant direction with coolant nozzle



Code system

C: 80° Diamond	D: 55° Diamond			DX: 65
S: 90° Square	T: 60° Triangle	N = 0°		H: 100
V: 35° Diamond	W: 80° Hexagon	B = 5°		L: 140
Insert Shape		Clearance angle of insert		Length of tool holder



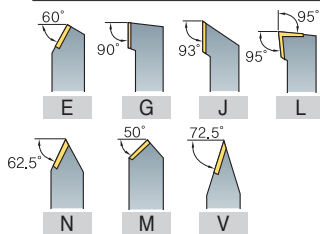
Taper design & size

50, 63UT
80ATC, 100

Clamping Type

D: Double Clamp
M: Multi Clamp
P: Lever Lock
S: Screw On
W: Wedge Clamp

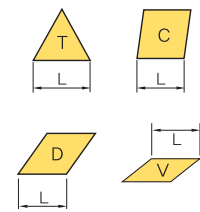
Holder Style



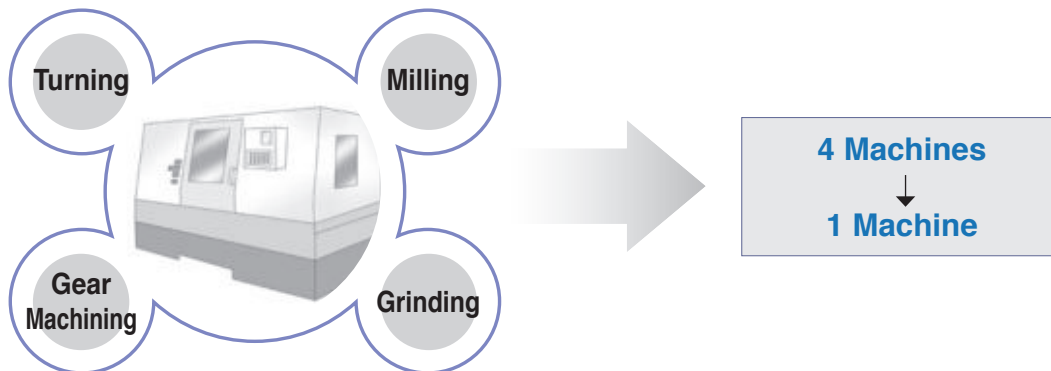
Hand

R: Right
L: Left
N: No Hand

Cutting edge Length



Multi-tasking machine



KM Tooling system is superior for wide application.

External Process

Internal Process

Grooving Process

Drill Process

Parting-off Process

KM50, KM63UT, KM80, KM100 Standard and Special type can be produced.



B Index for HSK/KM Tooling System

Index for HSK Tooling System

Cutting Shape								
Designation	H63T-DCLNR/L-DX12	H63T-DCMNN-H/L12	H63T-DDJNR/L-DX15	H63T-DDNNN-H/L15	H63T-PCLNR/L-DX12	H63T-PCMNN-H/L12	H63T-PDJNR/L-DX15	H63T-PDNNN-H/L15
Approach angle	95°	95°	93°	107.5°	95°	95°	93°	107.5°
Page	B231	B231	B231	B231	B232	B232	B232	B232
Turning	●	●	●	●	●	●	●	●
Copying			●	●			●	●
Facing	●	●	●	●	●	●	●	●
Back turning	●	●	●	●	●	●	●	●
Internal turning								

Cutting Shape								
Designation	H63T-PRGCR-DX12	H63T-PRDCN-H/L12	H63T-SVPBR/L-DX16	H63T-SVVBH-H/L16	H63T-A25K/A32L-DCLNR/L-12	H63T-MCFR/L	H63T-MCHR/L	
Approach angle	-	-	117.5°	117.5°	95°	-	-	
Page	B233	B233	B233	B233	B235	B235	B234	
Turning	●	●	●	●	●	●		
Copying	●	●	●	●	●	●		
Facing	●	●	●	●	●	●	●	
Back turning	●	●	●	●	●	●		
Internal turning					●			

Index for KM Tooling System

Cutting Shape						
Designation	KM50-DCLNR/L-C12 KM63UT-DCLNR/L-D12	KM50-DCMNN-C12 KM63UT-DCMNN-D12	KM50-DDJNR/L-C15(-3) KM63UT-DCJNR/L-D15(-3)	KM50-DDNNN-C15(-3) KM63UT-DDNNN-D15(-3)	KM50-A25K-DCLNR/L-12 KM50-A32K-DCLNR/L-12 KM63UT-A25K-DCLNR/L-12 KM63UT-A32L-DCLNR/L-12	KM50-PCLNR/L-C12 KM63UT-PCLNR/L-D12
Approach angle	95°	95°	93°	107.5°	95°	95°
Page	B237	B237	B237	B238	B240	B238
Turning	●	●	●	●	●	●
Copying			●	●		
Facing	●	●	●	●	●	●
Back turning	●	●	●	●	●	●
Internal turning					●	

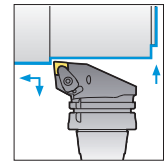
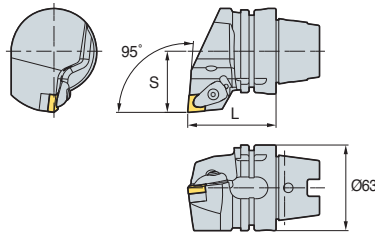
Cutting Shape						
Designation	KM50-PCMNN-C12 KM63UT-PCMNN-D12	KM50-PDJNR/L-C15(-3) KM63UT-PDJNR/L-D15(-3)	KM50-PDNNN-C15(-3) KM63UT-PDNNN-D15(-3)	KM50-MCHR/L KM63UT-MCHR/L		
Approach angle	95°	93°	107.5°	-		
Page	B238	B239	B239	B239		
Turning	●	●	●	●		
Copying		●	●	●		
Facing	●	●	●			
Back turning	●	●	●	●		
Internal turning						



DCLNR/L



CN□□



95°

• R type insert
(mm)

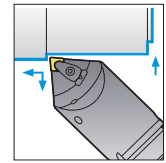
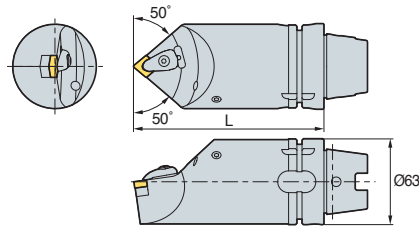
Designation	L	S	Insert	Clamp	Screw	Shim	Shim Screw	Spring	Nozzle	Plug	Wrench	Coolant Pipe
H63T-DCLNR/L-DX12	65	45	CN□□1204□□	CVH4	CHX0518	SC44V	FTKA0410	SPR0714	CN0605	-	HW30P	CP63T

↻ Applicable inserts B36~B42

DCMNN



CN□□



95°

(mm)

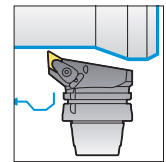
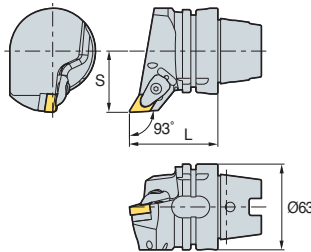
Designation	L	Insert	Clamp	Screw	Shim	Shim Screw	Spring	Nozzle	Plug	Wrench	Coolant Pipe
H63T-DCMNN-H12	100	CN□□1204□□	CVH4	CHX0518	SC44V	FTKA0410	SPR0714	CN0605	KHA0808	HW30P	CP63T
H63T-DCMNN-L12	140										

↻ Applicable inserts B36~B42

DDJNR/L



DN□□



93°

• R type insert
(mm)

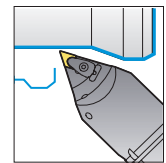
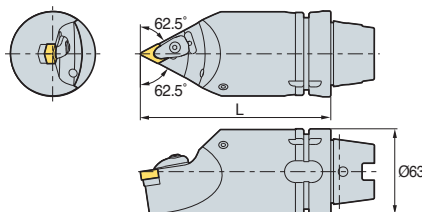
Designation	L	S	Insert	Clamp	Screw	Shim	Shim Screw	Spring	Nozzle	Plug	Wrench	Coolant Pipe
H63T-DDJNR/L-DX15	65	45	DN□□1506□□	CVH4	CHX0518	SD43V	FTKA0410	SPR0714	CN0605	-	HW30P	CP63T
H63T-DDJNR/L-DX15-3	65	45	DN□□1504□□			SD44V						

↻ Applicable inserts B43~B48

DDNNN



DN□□



107.5°

(mm)

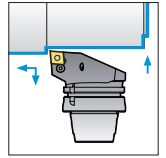
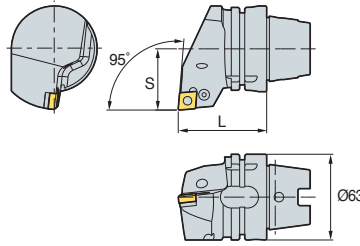
Designation	L	Insert	Clamp	Screw	Shim	Shim Screw	Spring	Nozzle	Plug	Wrench	Coolant Pipe
H63T-DDNNN-H15	100	DN□□1506□□	CVH4	CHX0518	SD43V	FTKA0410	SPR0714	CN0605	KHA0808	HW30P	CP63T
H63T-DDNNN-L15	140										
H63T-DDNNN-H15-3	100	DN□□1504□□	CVH4	CHX0518	SD44V	FTKA0410	SPR0714	CN0605	KHA0808	HW30P	CP63T
H63T-DDNNN-L15-3	140										

↻ Applicable inserts B43~B48

PCLNR/L



CN□□



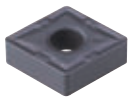
95°

• R type insert (mm)

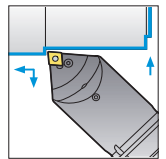
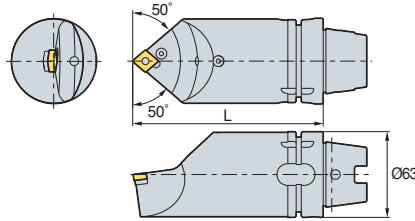
Designation	L	S	Insert	Lever	Screw	Shim	Shim Pin	Punching	Nozzle	Plug	Wrench	Coolant Pipe
H63T-PCLNR/L-DX12	65	45	CN□□1204□□	LV4N	VHX0820N	SC42N	SP4N	LSPS4	CN0605	-	HW30L	CP63T

↻ Applicable inserts B36~B42

PCMNN



CN□□



95°

(mm)

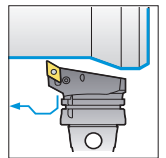
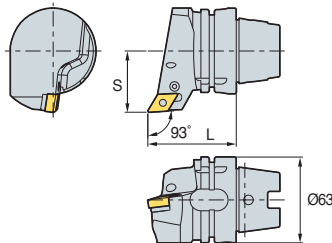
Designation	L	Insert	Lever	Screw	Shim	Shim Pin	Punching	Nozzle	Plug	Wrench	Coolant Pipe
H63T-PCMNN-H12	100	CN□□1204□□	LV4N	VHX0820N	SC42N	SP4N	LSPS4	CN0605	KHA0808	HW30L	CP63T
H63T-PCMNN-L12	140										

↻ Applicable inserts B36~B42

PDJNR/L



DN□□



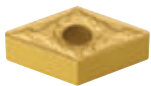
95°

• R type insert (mm)

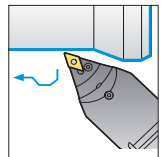
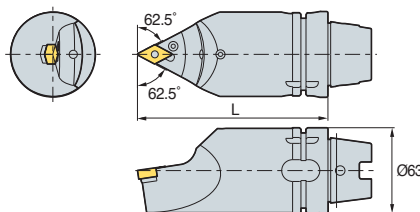
Designation	L	S	Insert	Lever	Screw	Shim	Shim Pin	Punching	Nozzle	Plug	Wrench	Coolant Pipe
H63T-PDJNR/L-DX15	65	45	DN□□1506□□	LV4BN	VHX0821N	SD42N	SP4N	LSPS4	CN0605	-	HW30L	CP63T
H63T-PDJNR/L-DX15-3	65	45	DN□□1504□□			SD43N						

↻ Applicable inserts B43~B48

PDNNN



DN□□



107.5°

(mm)

Designation	L	Insert	Lever	Screw	Shim	Shim Pin	Punching	Nozzle	Plug	Wrench	Coolant Pipe
H63T-PDNNN-H15	100	DN□□1506□□	LV4BN	VHX0821N	SD42N	SP4N	LSPS4	CN0605	KHA0808	HW30L	CP63T
H63T-PDNNN-L15	140										
H63T-PDNNN-H15-3	100	DN□□1504□□	LV4BN	VHX0821N	SD43N	SP4N	LSPS4	CN0605	KHA0808	HW30L	CP63T
H63T-PDNNN-L15-3	140										

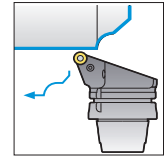
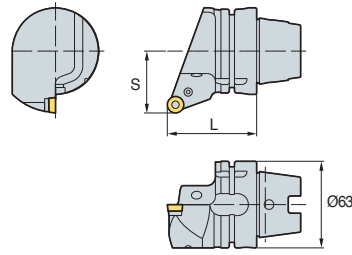
↻ Applicable inserts B43~B48



PRGCR/L



RCMX1204M0



• R type insert
(mm)

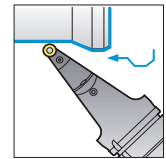
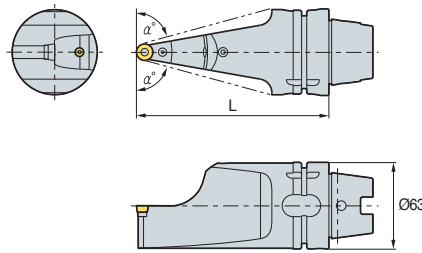
Designation	L	S	Insert	Lever	Screw	Shim	Shim Pin	Punching	Nozzle	Plug	Wrench	Coolant Pipe
H63T-PRGCR/L-DX12	65	45	RCMX1204M0	LR12	VHX0617	SR12	SP3	LSPS3	CN0605	-	HW25L	CP63T

↻ Applicable inserts **B83, B105**

PRDCN



RCMX1204M0

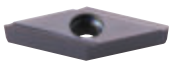


(mm)

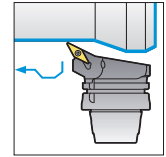
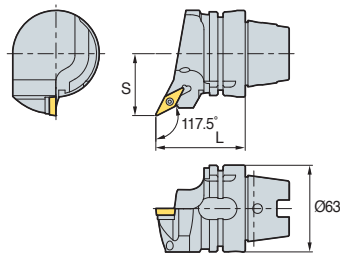
Designation	L	α°	Insert	Lever	Screw	Shim	Shim Pin	Punching	Nozzle	Plug	Wrench	Coolant Pipe
H63T-PRDCN-H12	100	69	RCMX1204M0	LR12	VHX0617	SR12	SP3	LSPS3	CN0605	-	HW25L	CP63T
H63T-PRDCN-L12	140	75										

↻ Applicable inserts **B83, B105**

SVPBR/L



VB□T



117.5°

• R type insert
(mm)

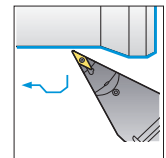
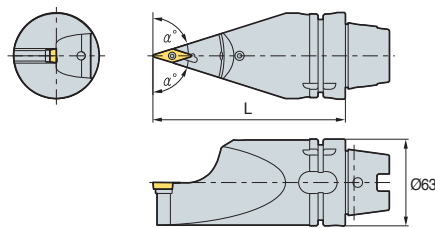
Designation	L	S	Insert	Screw	Shim Screw	Shim	Nozzle	Plug	Wrench	Wrench	Coolant Pipe
H63T-SVPBR/L-DX16	65	45	VB□T1604□□	FTGA03512	SHXN0509F	SV32S	CN0605	-	TW15P	HW32L	CP63T

↻ Applicable inserts **B94~B96, B108**

SVVBN



VB□T



117.5°

(mm)

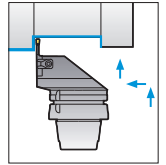
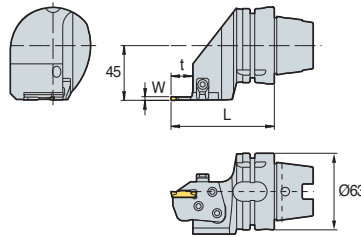
Designation	L	α°	Insert	Screw	Shim Screw	Shim	Nozzle	Plug	Wrench	Wrench	Coolant Pipe
H63T-SVVBN-H16	100	66.5	VB□T1604□□	FTGA03512	SHXN0509F	SV32S	CN0605	KHA0808	TW15P	HW32L	CP63T
H63T-SVVBN-L16	140	72.5									

↻ Applicable inserts **B94~B96, B108**

MCHR/L



MGMN / MGMR/L
MGGN / MRMN



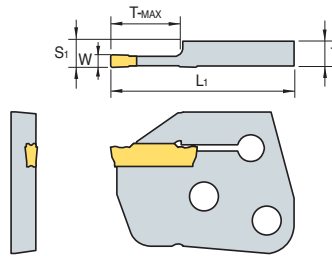
• R type insert
(mm)

Designation	L	t	W	T-MAX	Insert	Cartridge	Clamp	Clamp Screw	Hinge Screw	Screw	Nozzle	Plug	Wrench	Coolant Pipe
H63T-MCHR/L	85	18	3	16	MGMN	MCER/L3-T16	CHX8N	DHA0818F	RHA0613	FHGA0618	CN0605	-	HW40L	CP63T
	85	18	4	16	MGMR/L	MCER/L4-T16								
	89	22	5	20	MGGN	MCER/L5-T20								
	89	22	6	20	MRMN	MCER/L6-T20								

MCER/L (Cartridge)



MGMN / MGMR/L
MGGN / MRMN



• R type insert
(mm)

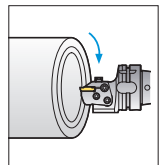
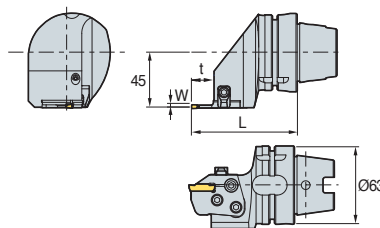
Designation	L	L ₁	S ₁	T-MAX	Insert		Tool holders	
					W	Designation		
MCER/L	3-T16	6.00	44.5	6.35	16	3	MGMN	H63T-MCHR/L
	4-T16	5.97	44.5	6.35	16	4	MGMR/L	
	5-T20	5.87	48.5	6.35	20	5	MGGN	
	6-T20	5.82	48.5	6.35	20	6	MGMN	

↻ Applicable inserts C28~C30

MCHR/L



MFMN300
MGMN400



• R type insert
(mm)

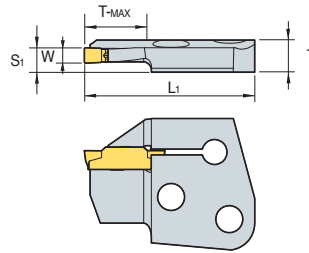
Designation	L	t	W	T-MAX	Insert	Cartridge	Clamp	Clamp Screw	Hinge Screw	Screw	Nozzle	Plug	Wrench	Coolant Pipe
H63T-MCHR/L	85	18	3	16	MFMN300	MCFR/L3-24/35-T16	CHX8N	DHA0818F	RHA0613	FHGA0618	CN0605	-	HW40L	
	85	18	3	16		MCFR/L3-29/40-T16								
	85	18	3	16		MCFR/L3-34/50-T16								
	85	18	3	16		MCFR/L3-44/70-T16								
	85	18	3	16		MCFR/L3-64/99-T16								
	85	18	3	16	MGMN400	MCFR/L4-44/60-T16								
	85	18	3	16		MCFR/L4-60/120-T16								
	85	18	3	16		MCFR/L4-112/200-T16								



MCFR/L (Cartridge)



MFMN300
MGMN400



• R type insert (mm)

Designation	T	L ₁	S ₁	T-MAX	Insert		Tool holders	
					W	Designation		
MCFR/L3-	24/35-T16	8.00	44.5	6.35	16	3	H63T-MCHR/L	
	29/40-T16	8.00	44.5	6.35	16	3		
	34/50-T16	8.00	44.5	6.35	16	3		
	44/70-T16	8.00	44.5	6.35	16	3		
MCFR/L4-	64/99-T16	8.00	44.5	6.35	16	3		
	44/60-T16	7.97	44.5	6.35	16	4		MGMN400
	60/120-T16	7.97	44.5	6.35	16	4		
112/200-T16	7.97	44.5	6.35	16	4			

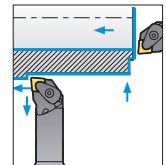
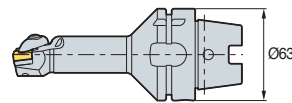
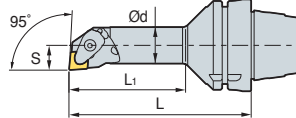
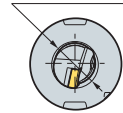
↻ Applicable inserts C28~C30

DCLNR/L



CN□□

ØD Min. machining Dia.



95°

• R type insert (mm)

Designation	ØD	Ød	L	L ₁	S	Insert	Clamp	Screw	Shim	Shim Screw	Spring	Nozzle	Plug	Wrench	Coolant Pipe
H63T-A25K-DCLNR/L-12	32	25	125	80	17	CN□□1204□□									
H63T-A32L-DCLNR/L-12	40	32	140	98	22										

↻ Applicable inserts B36~B42

Blank Tool

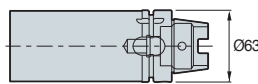
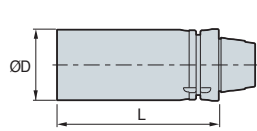


Fig. 1

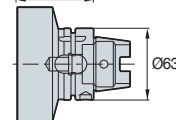
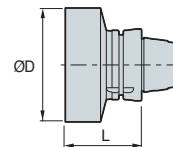


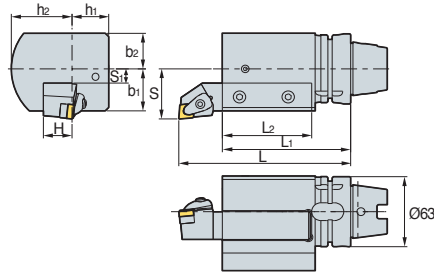
Fig. 2

(mm)

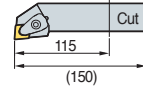
Designation	ØD	L	Fig.	Coolant Pipe
HSK-T63-BL62-102	62	102	1	 CP63T
HSK-T63-BL62-142	62	142	2	
HSK-T63-BL100-67	100	67	1	
HSK-T63-BL120-70	120	70	2	



EV2525R/L-112



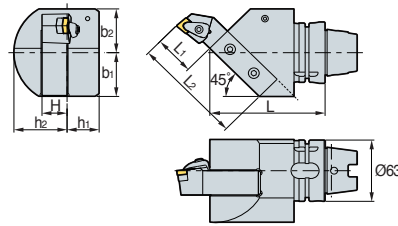
- **Holder information**
- Holder size: 25 x 25
- Before setting the holder, please cut the holder length to 115 mm.



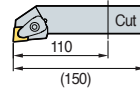
• R type insert (mm)

Designation	L	L ₁	L ₂	H	h ₁	h ₂	S	S ₁	b ₁	b ₂	Screw	Plug	Nozzle	Wrench	Coolant Pipe
EV2525R/L-112	150	112	77	25	32	53	45	12.75	37.75	32	KHA1231	KHA0808	CN0605	HW50L	CP63T

EV2525R/L-115



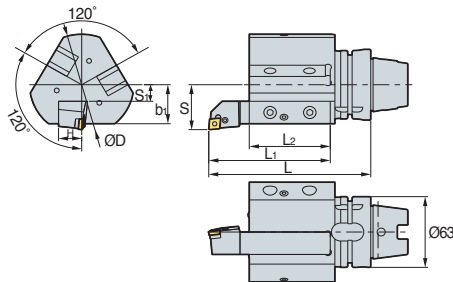
- **Holder information**
- Holder size: 25 x 25
- Before setting the holder, please cut the holder length to 110 mm.



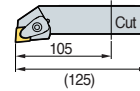
• R type insert (mm)

Designation	L	L ₁	L ₂	H	h ₁	h ₂	b ₁	b ₂	Screw	Plug	Nozzle	Wrench	Coolant Pipe
EV2525R/L-115	115	40	110	25	32	53	45	45	KHA1231	KHA0808	CN0605	HW50L	CP63T

EV2020R/L-105-3



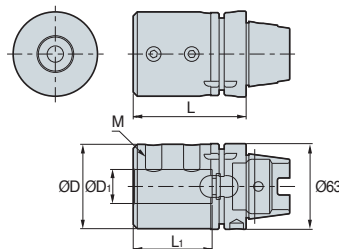
- **Holder information**
- Holder size: 20 x 20
- Before setting the holder, please cut the holder length to 105 mm.



• R type insert (mm)

Designation	L	L ₁	L ₂	H	ØD	S	S ₁	B ₁	Screw	Plug	Nozzle	Wrench	Coolant Pipe
EV2020R/L-105-3	140	105	70	20	90	40	15	35	KHA1231	KHA0808	CN0605	HW50L	CP63T

B○○-○○



• R type insert (mm)

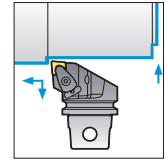
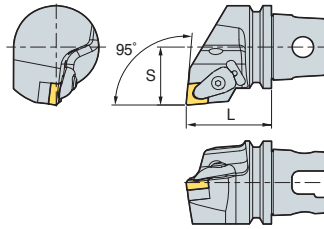
Designation	ØD	D ₁	L	L ₁	M	Screw	Wrench	Coolant Pipe
B08-65	28	8	65	40	M8	KHA1218	HW50L	CP63T
B10-70	35	10	70	45	M8			
B12-70	42	12	70	45	M8			
B16-75	48	16	75	50	M10			
B20-75	52	20	75	50	M10			
B25-83	62	25	83	58	M12			
B32-87	62	32	87	62	M12			
B40-97	65	40	97	72	M16			



DCLNR/L



CN□□



95°

• R type insert
(mm)

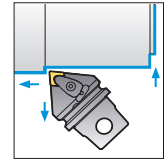
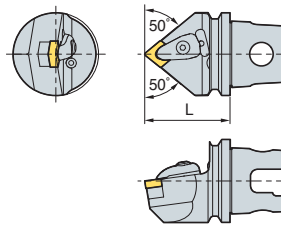
Designation	L	S	Insert	Clamp	Screw	Shim	Shim Screw	Spring	Nozzle	Plug	Wrench
KM50-DCLNR/L-C12	50	35	CN□□1204□□	CVH4	CHX0518	SC44V	FTKA0410	SPR0714	CN0605	-	HW30P
KM63UT-DCLNR/L-D12	60	43									

➔ Applicable inserts B36~B42

DCMNN



CN□□



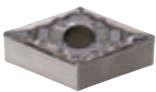
95°

(mm)

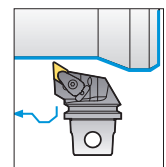
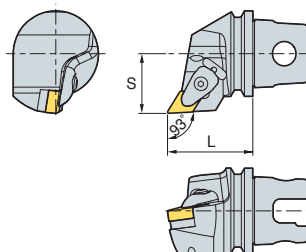
Designation	L	Insert	Clamp	Screw	Shim	Shim Screw	Spring	Nozzle	Plug	Wrench
KM50-DCMNN-C12	50	CN□□1204□□	CVH4	CHX0518	SC44V	FTKA0410	SPR0714	CN0605	KHA0808	HW30P
KM63UT-DCMNN-D12	60									

➔ Applicable inserts B36~B42

DDJNR/L



DN□□



93°

• R type insert
(mm)

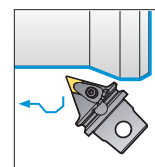
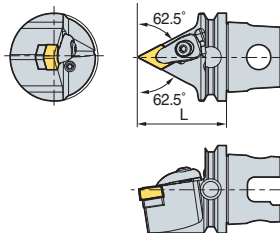
Designation	L	S	Insert	Clamp	Screw	Shim	Shim Screw	Spring	Nozzle	Plug	Wrench
KM50-DDJNR/L-C15	50	35	DN□□1506□□	CVH4	CHX0518	SD43V	FTKA0410	SPR0714	CN0605	-	HW30P
KM50-DDJNR/L-C15-3	50	35	DN□□1504□□	CVH4	CHX0518	SD44V	FTKA0410	SPR0714	CN0605	-	HW30P
KM63UT-DDJNR/L-D15	60	43	DN□□1506□□	CVH4	CHX0518	SD43V	FTKA0410	SPR0714	CN0605	-	HW30P
KM63UT-DDJNR/L-D15-3	60	43	DN□□1504□□	CVH4	CHX0518	SD44V	FTKA0410	SPR0714	CN0605	-	HW30P

➔ Applicable inserts B43~B48

DDNNN



DN□□



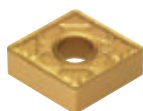
117.5°

(mm)

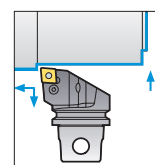
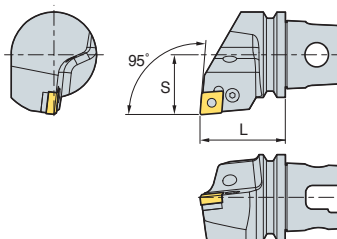
Designation	L	Insert	Clamp	Screw	Shim	Shim Screw	Spring	Nozzle	Plug	Wrench
KM50-DDNNN-C15	50	DN□□1506□□	CVH4	CHX0518	SD43V	FTKA0410	SPR0714	CN0605	KHA0808	HW30P
KM50-DDNNN-C15-3	50	DN□□1504□□	CVH4	CHX0518	SD44V	FTKA0410	SPR0714	CN0605	KHA0808	HW30P
KM63UT-DDNNN-D15	60	DN□□1506□□	CVH4	CHX0518	SD43V	FTKA0410	SPR0714	CN0605	KHA0808	HW30P
KM63UT-DDNNN-D15-3	60	DN□□1504□□	CVH4	CHX0518	SD44V	FTKA0410	SPR0714	CN0605	KHA0808	HW30P

↻ Applicable inserts B43~B48

PCLNR/L



CN□□



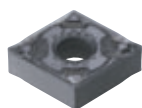
95°

• R type insert
(mm)

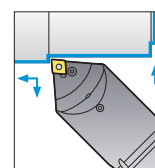
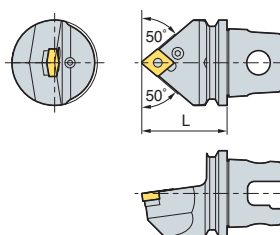
Designation	L	S	Insert	Lever	Screw	Shim	Shim Pin	Punching	Nozzle	Plug	Wrench
KM50-PCLNR/L-C12	50	35	CN□□1204□□	LV4N	VHX0820N	SC42N	SP4N	LSPS4	CN0605	-	HW30L
KM63UT-PCLNR/L-D12	60	43									

↻ Applicable inserts B36~B42

PCMNN



CN□□



95°

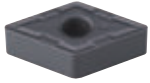
(mm)

Designation	L	Insert	Lever	Screw	Shim	Shim Pin	Punching	Nozzle	Plug	Wrench
KM50-PCMNN-C12	50	CN□□1204□□	LV4N	VHX0820N	SC42N	SP4N	LSPS4	CN0605	KHA0808	HW30L
KM63UT-PCMNN-D12	60									

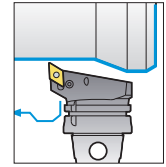
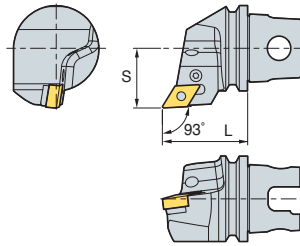
↻ Applicable inserts B36~B42



PDJNR/L



DN□□



93°

• R type insert (mm)

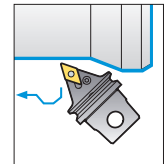
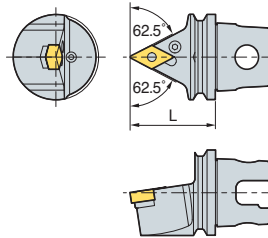
Designation	L	S	Insert	Lever	Screw	Shim	Shim Pin	Punching	Nozzle	Plug	Wrench
KM50-PDJNR/L-C15	50	35	DN□□1506□□	LV4BN	VHX0821N	SD42N	SP4N	LSPS4	CN0605	-	HW30L
KM50-PDJNR/L-C15-3	50	35	DN□□1504□□	LV4BN	VHX0821N	SD43N	SP4N	LSPS4	CN0605	-	HW30L
KM63UT-PDJNR/L-D15	60	43	DN□□1506□□	LV4BN	VHX0821N	SD42N	SP4N	LSPS4	CN0605	-	HW30L
KM63UT-PDJNR/L-D15-3	60	43	DN□□1504□□	LV4BN	VHX0821N	SD43N	SP4N	LSPS4	CN0605	-	HW30L

↻ Applicable inserts B43~B48

PDNNN



DN□□



107.5°

(mm)

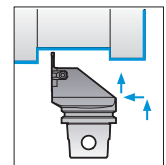
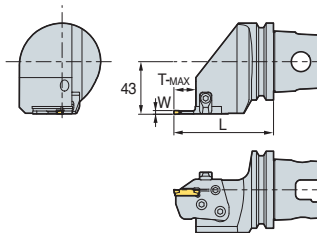
Designation	L	Insert	Lever	Screw	Shim	Shim Pin	Punching	Nozzle	Plug	Wrench
KM50-PDNNN-C15	50	DN□□1506□□	LV4BN	VHX0821N	SD42N	SP4N	LSPS4	CN0605	KHA0808	HW30L
KM50-PDNNN-C15-3	50	DN□□1504□□	LV4BN	VHX0821N	SD43N	SP4N	LSPS4	CN0605	KHA0808	HW30L
KM63UT-PDNNN-D15	60	DN□□1506□□	LV4BN	VHX0821N	SD42N	SP4N	LSPS4	CN0605	KHA0808	HW30L
KM63UT-PDNNN-D15-3	60	DN□□1504□□	LV4BN	VHX0821N	SD43N	SP4N	LSPS4	CN0605	KHA0808	HW30L

↻ Applicable inserts B43~B48

MCHR/L



MGMN / MGMR/L
MGGN / MRMN



• R type insert (mm)

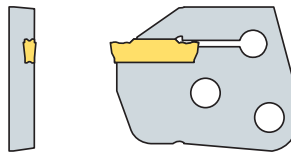
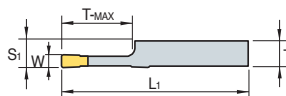
Designation	S	L	t	W	T-MAX	Insert	Cartridge	Clamp	Clamp Screw	Hinge Screw	Screw	Nozzle	Plug	Wrench
KM50-MCHR/L	35	72.5	18	3	16	MGMN MGMR/L MGGN MRMN	MCER/L3-T16	CHX8N	DHA0818F	RHA0613	FHGA0618	CN0605	-	HW40L
	35	72.5	18	4	16		MCER/L4-T16							
	35	76.5	22	5	20		MCER/L5-T20							
	35	76.5	22	6	20		MCER/L6-T20							
KM63UT-MCHR/L	43	81.5	18	3	16		MCER/L3-T16	CHX8N	DHA0818F	RHA0613	FHGA0618	CN0605	-	HW40L
	43	81.5	18	4	16		MCER/L4-T16							
	43	85.5	22	5	20		MCER/L5-T20							
	43	85.5	22	6	20		MCER/L6-T20							

↻ Applicable inserts C28~C30

MCER/L (Cartridge)



MGMN / MGMR/L
MGGN / MRMN



• R type insert
(mm)

Designation	T	L ₁	S ₁	T-MAX	Insert		Tool holders	
					W	Designation		
MCER/L	3-T16	6.00	44.5	6.35	16	3	MGMN	H-63T-MCHR/L
	4-T16	5.97	44.5	6.35	16	4	MGMR/L	
	5-T20	5.87	48.5	6.35	20	5	MGGN	
	6-T20	5.82	48.5	6.35	20	6	MRMN	

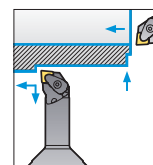
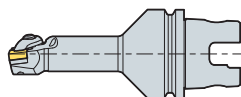
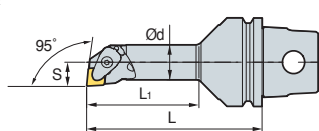
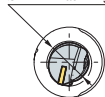
➔ Applicable inserts C28~ C30

KM○○-DCLNR/L



CN□□

ØD Min. machining Dia.



95°

• R type insert
(mm)

Designation	ØD	Ød	L	L ₁	S	Insert	Clamp	Screw	Shim	Shim Screw	Spring	Nozzle	Plug	Wrench
KM50-A25K-DCLNR/L-12	32	25	125	80	17	CN□□1204□□								
KM50-A32L-DCLNR/L-12	40	32	140	98	22									
KM63UT-A25K-DCLNR/L-12	32	25	125	80	17									
KM63UT-A32L-DCLNR/L-12	40	32	140	98	22									

➔ Applicable inserts B36~B42

Blank Tool

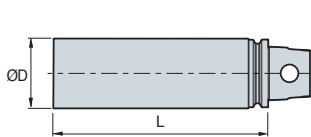


Fig. 1

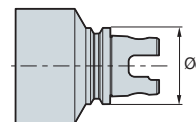
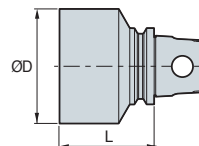


Fig. 2

(mm)

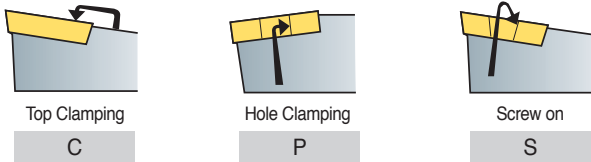
Designation	ØD	L	Ød	Fig.
KM50-BL7562	45	62	50	1
KM50-BL10562	105	62	50	2
KM63UT-BL65200	65	200	50	1
KM63UT-BL115150	115	150	50	2



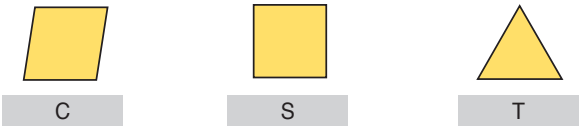
S T F C R 12 C A - 16

1 Method of Mounting Insert 2 Insert Shape 3 Holder Style 4 Relief Angle of Insert 5 Hand 6 Height of Cutting Edge 7 Cartridge Code 8 Type of Cartridge 9 Length of Cutting Edge

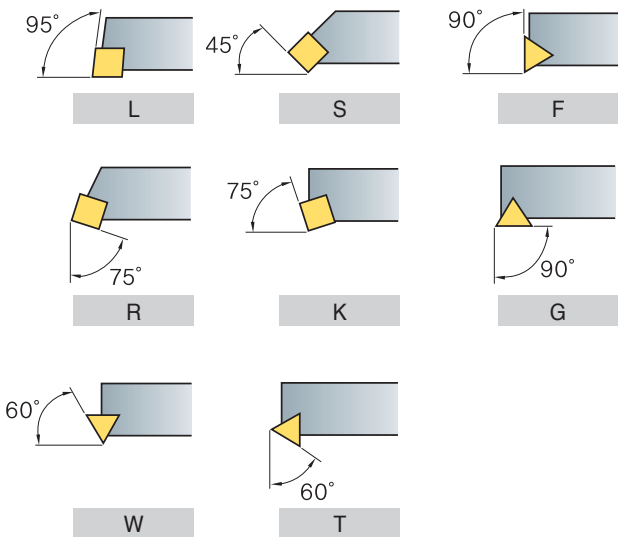
1 Method of Mounting Insert
S T F C R 12 C A - 16



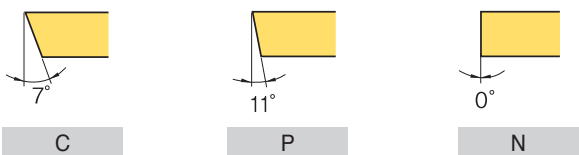
2 Insert Shape
S T F C R 12 C A - 16



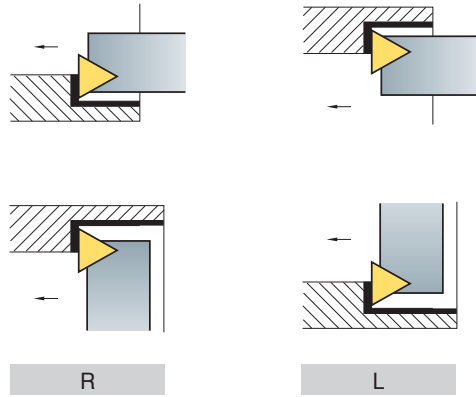
3 Holder Style
S T F C R 12 C A - 16



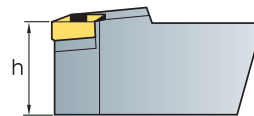
4 Relief Angle of Insert
S T F C R 12 C A - 16



5 Hand
S T F C R 12 C A - 16



6 Height of Cutting Edge
S T F C R 12 C A - 16



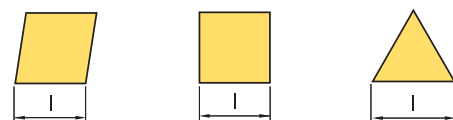
7 Cartridge Code
S T F C R 12 C A - 16

C (Cartridge)

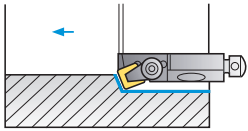
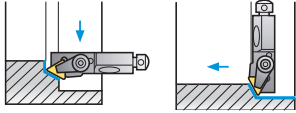
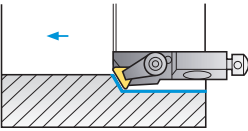
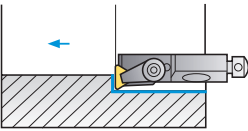
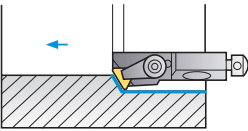
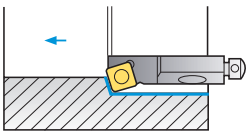
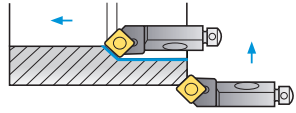
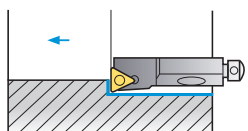
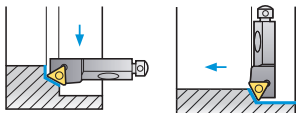
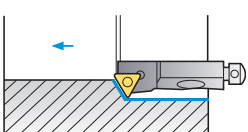
8 Type of Cartridge
S T F C R 12 C A - 16

A (ISO5611)

9 Length of Cutting Edge
S T F C R 12 C A - 16

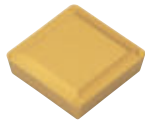


B Index for Cartridge

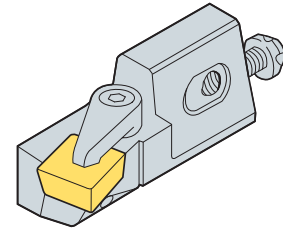
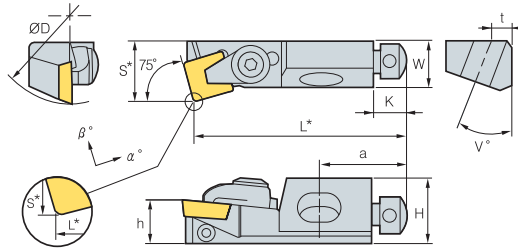
	Cutting Shape	Turning	Copying	Facing	Chamfering	Applicable inserts	Page	
Clamp on System	CSKPR/L 	10CA-09 12CA-12	●				SP□R0903□□ SP□R1203□□	B243
	CTTPR/L 	10CA-11 12CA-16	●				TP□R1103□□ TP□R1603□□	B244
	CTWPR/L 	10CA-11 12CA-16	●				TP□R1103□□ TP□R1603□□	B245
	CTFPR/L 	10CA-11 12CA-16	●		●		TP□R1103□□ TP□R1603□□	B243
	CTSPR/L 	10CA-11 12CA-16	●				TP□R1103□□ TP□R1603□□	B244
Screw on System	SSKCR/L 	10CA-09 12CA-12	●				SC□T09T3□□ SC□T1204□□	B245
	SSSCR/L 	10CA-09 12CA-12	●		●		SC□T09T3□□ SC□T1204□□	B246
	STFCR/L 	10CA-11 12CA-16	●		●		TC□T1102□□ TC□T16T3□□	B246
	STTCR/L 	10CA-11 12CA-16	●		●		TC□T1102□□ TC□T16T3□□	B247
	STWCR/L 	10CA-11 12CA-16	●				TC□T1102□□ TC□T16T3□□	B247



CSKPR/L



SP□R



• R type insert (mm)

Designation	ØD	H	W	L*	S*	h	K	α°	β°	a	t	v°	Insert
CSKPR/L 10CA-09	40	15	11	50	14	10	8	6	0	20	5	20	SP□R0903□□
12CA-12	50	20	15	55	20	12	8	6	0	20	6	20	SP□R1203□□

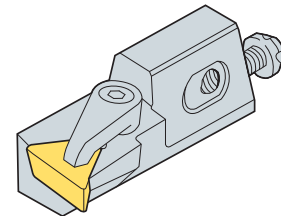
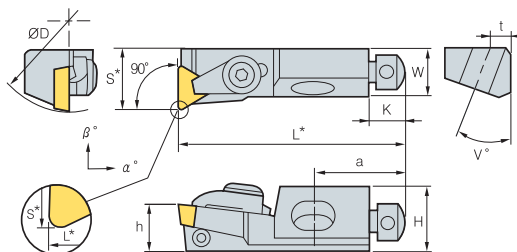
➔ Applicable inserts **B76~B77** · a base Insert : r = 0.8 D = ØD Min. machining Dia.

Parts	Clamp	Axial Adjust Screw	Radial Adjust Screw	MountingScrew	Washer	Wrench	Wrench
CSKPR/L 10CA-09	CA05R	AZ0508F	KHA0408	RHA0620	WA0602	TW 15P	HW20L
12CA-12	CA06R	AZ0508F	KHA0412	RHA0625	WA0602	TW 15P	HW20L

CTFPR/L



TP□R



• R type insert (mm)

Designation	ØD	H	W	L*	S*	h	K	α°	β°	a	t	v°	Insert
CTFPR/L 10CA-11	40	15	11	50	14	10	8	6	0	20	5	20	TP□R1103□□
12CA-16	50	20	15	55	20	12	8	6	0	20	6	20	TP□R1603□□

➔ Applicable inserts **B81~B83** · a base Insert : r = 0.4 (l=11) r = 0.8 (l=16) D = ØD Min. machining Dia.

Parts	Clamp	Axial Adjust Screw	Radial Adjust Screw	MountingScrew	Washer	Wrench	Wrench
CTFPR/L 10CA-11	CA05R	AZ0508F	KHA0408	RHA0620	WA0602	TW25L	HW20L
12CA-16	CA06R	AZ0508F	KHA0412	RHA0625	WA0602	TW30L	HW20L

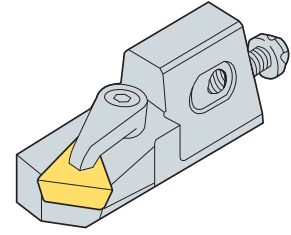
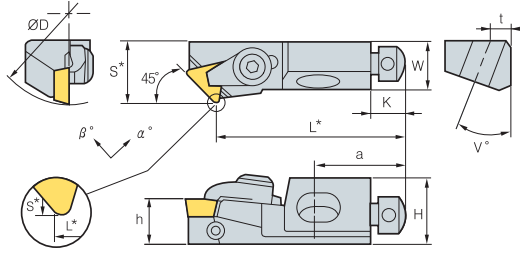


B Clamp on System

CTSPR/L



TP□R



• R type insert (mm)

Designation	ØD	H	W	L*	S*	h	K	α°	β°	a	t	v°	Insert
CTSPR/L 10CA-11	40	15	11	44	14	10	8	4	0	20	5	20	TP□R1103□□
12CA-16	50	20	15	47	20	12	8	5	0	20	6	20	TP□R1603□□

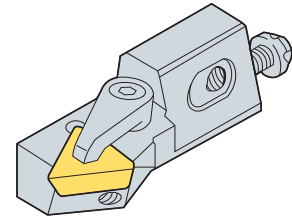
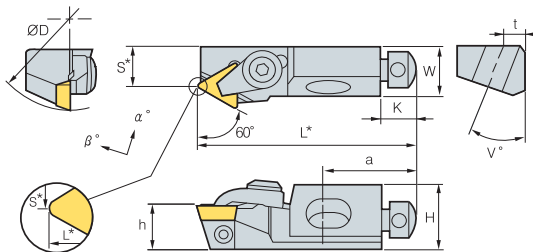
↻ Applicable inserts B81~B83 · a base Insert : r = 0.4 (l = 11) r = 0.8 (l = 16) D = ØD Min. machining Dia.

Parts	Clamp	Axial Adjust Screw	Radial Adjust Screw	MountingScrew	Washer	Wrench	Wrench
CTSPR/L 10CA-11	CA05R	AZ0508F	KHA0408	RHA0620	WA0602	TW25L	HW20L
12CA-16	CA06R	AZ0508F	KHA0412	RHA0625	WA0602	TW30L	HW20L

CTTPR/L



TP□R



• R type insert (mm)

Designation	ØD	H	W	L*	S*	h	K	α°	β°	a	t	v°	Insert
CTTPR/L 10CA-11	40	15	11	50	9	10	8	5	0	20	5	20	TP□R1103□□
12CA-16	50	20	15	55	20	12	8	5	0	20	6	20	TP□R1603□□

↻ Applicable inserts B81~B83 · a base Insert : r = 0.8 D = ØD Min. machining Dia.

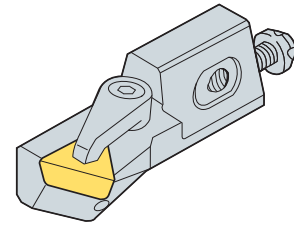
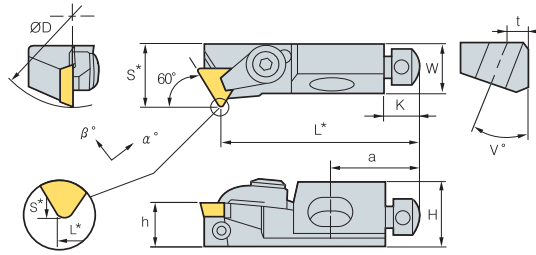
Parts	Clamp	Axial Adjust Screw	Radial Adjust Screw	MountingScrew	Washer	Wrench	Wrench
CTTPR/L 10CA-11	CA05R	AZ0508F	KHA0408	RHA0620	WA0602	TW25L	HW20L
12CA-16	CA06R	AZ0508F	KHA0412	RHA0625	WA0602	TW30L	HW20L



CTWPR/L



TP□R



• R type insert (mm)

Designation	ØD	H	W	L*	S*	h	K	α°	β°	a	t	v°	Insert
CTWPR/L 10CA-11	40	15	11	44	14	10	8	5	0	20	5	20	TP□R1103□□
12CA-16	50	20	15	47	20	12	8	5	0	20	6	20	TP□R1603□□

➔ Applicable inserts B81~B83

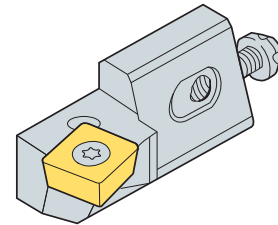
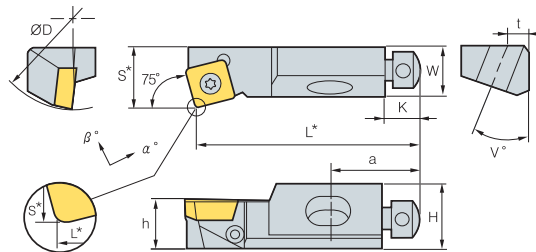
· a base Insert : r = 0.8 D = ØD Min. machining Dia.

Parts	Clamp	Axial Adjust Screw	Radial Adjust Screw	MountingScrew	Washer	Wrench	Wrench
CTWPR/L 10CA-11	CA05R	AZ0508F	KHA0408	RHA0620	WA0602	TW25L	HW20L
12CA-16	CA06R	AZ0508F	KHA0412	RHA0625	WA0602	TW30L	HW20L

SSKCR/L



SC□□



• R type insert (mm)

Designation	ØD	H	W	L*	S*	h	K	α°	β°	a	t	v°	Insert
SSKCR/L 10CA-09	40	15	11	50	14	10	8	0	-4	20	5	20	SC□□09T3□□
12CA-12	50	20	15	55	20	12	8	0	-4	20	6	20	SC□□1204□□

➔ Applicable inserts B74~B75, B94

· a base Insert : r = 0.8 D = ØD Min. machining Dia.

Parts	Screw	Axial Adjust Screw	Radial Adjust Screw	MountingScrew	Washer	Wrench	Wrench
SSKCR/L 10CA-09	FTGA03508	AZ0508F	KHA0408	RHA0620	WA0602	TW 15P	HW20L
12CA-12	FTGA0411F	AZ0508F	KHA0412	RHA0625	WA0602	TW 15P	HW20L

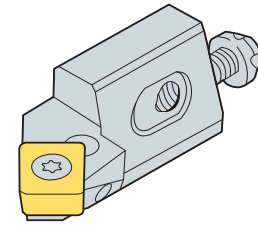
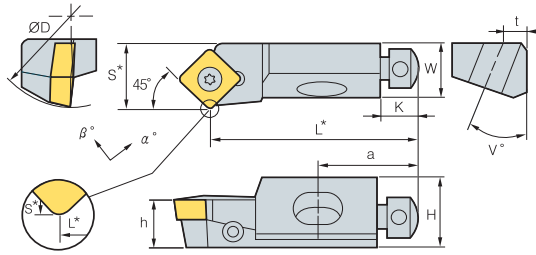


B Screw on System

SSSCR/L



SC□□



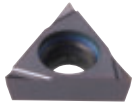
• R type insert (mm)

Designation	ØD	H	W	L*	S*	h	K	α°	β°	a	t	v°	Insert
SSSCR/L 10CA-09	40	15	11	44	14	10	8	-5	0	20	5	20	SC□□09T3□□
12CA-12	50	20	15	47	20	12	8	-5	0	20	6	20	SC□□1204□□

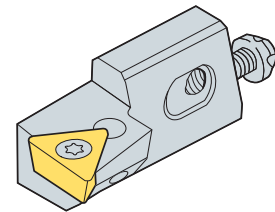
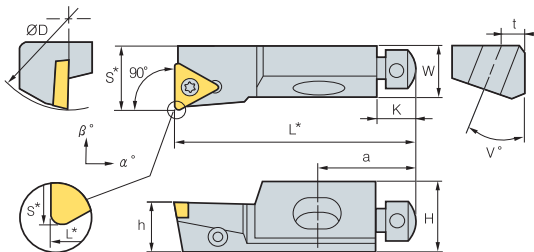
↻ Applicable inserts B74~B75, B94 · a base Insert : r = 0.8 D = ØD Min. machining Dia.

Parts	Screw	Axial Adjust Screw	Radial Adjust Screw	MountingScrew	Washer	Wrench	Wrench
SSSCR/L 10CA-09	FTGA03508	AZ0508F	KHA0408	RHA0620	WA0602	TW 15P	HW20L
12CA-12	FTGA0411F	AZ0508F	KHA0412	RHA0625	WA0602	TW 15P	HW20L

STFCR/L



TC□□



• R type insert (mm)

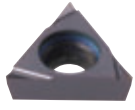
Designation	ØD	H	W	L*	S*	h	K	α°	β°	a	t	v°	Insert
STFCR/L 10CA-11	40	15	11	50	14	10	8	0	-3	20	5	20	TC□□1102□□
12CA-16	50	20	15	55	20	12	8	0	-3	20	6	20	TC□□16T3□□

↻ Applicable inserts B79~B80, B95 · a base Insert : r = 0.4 (l=11) r = 0.8 (l=16) D = Min. machining Dia.

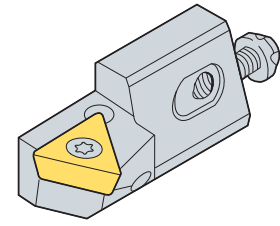
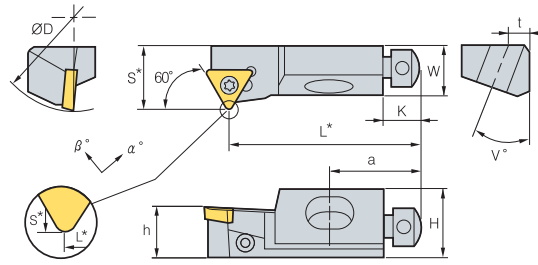
Parts	Screw	Axial Adjust Screw	Radial Adjust Screw	MountingScrew	Washer	Wrench	Wrench
STFCR/L 10CA-11	FTKA02565	AZ0508F	KHA0408	RHA0620	WA0602	TW 15P	HW20L
12CA-16	FTKA03508	AZ0508F	KHA0412	RHA0625	WA0602	TW 15P	HW20L



STTCR/L



TC□□



• R type insert (mm)

Designation	ØD	H	W	L*	S*	h	K	α°	β°	a	t	v°	Insert
STTCR/L 10CA-11	40	15	11	50	9	10	8	-5	0	20	5	20	TC□□1102□□
12CA-16	50	20	15	47	20	12	8	-3	0	20	6	20	TC□□16T3□□

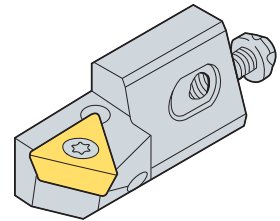
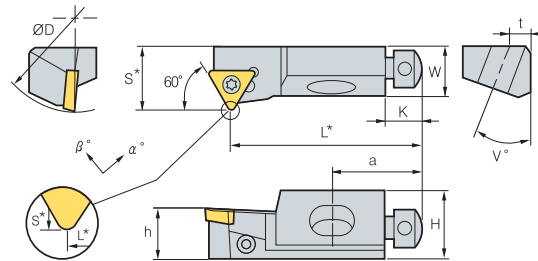
➔ Applicable inserts B79~B80, B95 · a base Insert : r = 0.4 (l = 11) r = 0.8 (l = 16) D = Min. machining Dia.

Parts	Screw	Axial Adjust Screw	Radial Adjust Screw	Mounting Screw	Washer	Wrench	Wrench
STTCR/L 10CA-11	FTKA02565	AZ0508F	KHA0408	RHA0620	WA0602	TW 07P	HW20L
12CA-16	FTKA03508	AZ0508F	KHA0412	RHA0625	WA0602	TW 15P	HW20L

STWCR/L



TC□□



• R type insert (mm)

Designation	ØD	H	W	L*	S*	h	K	α°	β°	a	t	v°	Insert
STWCR/L 10CA-11	40	15	11	44	14	10	8	0	-4	20	5	20	TC□□1102□□
12CA-16	50	20	15	47	20	12	8	-5	0	20	6	20	TC□□16T3□□

➔ Applicable inserts B79~B80, B95 · a base Insert : r = 0.4 (l = 11) r = 0.8 (l = 16) D = Min. machining Dia.

Parts	Screw	Axial Adjust Screw	Radial Adjust Screw	Mounting Screw	Washer	Wrench	Wrench
STWCR/L 10CA-11	FTKA02565	AZ0508F	KHA0408	RHA0620	WA0602	TW 15P	HW20L
12CA-16	FTKA03508	AZ0508F	KHA0412	RHA0625	WA0602	TW 15P	HW20L

MULTI FUNCTIONAL TOOLS

Korloy Multi-functional tools can be used for machining in grooving, parting-off, facing and forming applications. Its design ensures superior machinability and productivity.



Application Example

- C02** Application Example
- C04** Technical Information for Multi Functional tools

KGT

- C07** Technical Information for KGT
- C12** KGT
- C25** KGT Blade for Parting off

MGT

- C26** Technical Information for MGT
- C28** MGT
- C36** MGT (Face grooving)

KGT/MGT Cartridge

- C39** Technical Information for KGT/MGT Cartridge
- C40** KGT/MGT Cartridge Holder
- C41** KGT Cartridge
- C42** MGT Cartridge

MGT Aluminum Wheel Series

- C43** Technical Information for MGT Aluminum Wheel
- C44** MGT Aluminum Wheel

TB/TB-M

- C47** Technical Information for TB/TB-M
- C51** TB/TB-M

K Notch

- C55** Technical Information for K Notch
- C57** K Notch

Saw Man

- C60** Technical Information for Saw Man
- C61** Saw Man

Saw Man-X

- C63** Technical Information for Saw Man-X
- C65** Saw Man-X

Fine Tools

- C67** Technical Information for Fine Tools
- C68** Fine Tools

Grooving/Parting off

- C70** IGH
- C70** DBH
- C71** GFIP

Special Order Form

- C72** Special Order Form for MGT
- C73** Special Order Form for V-Pulley Insert

C Application Example

For external machining

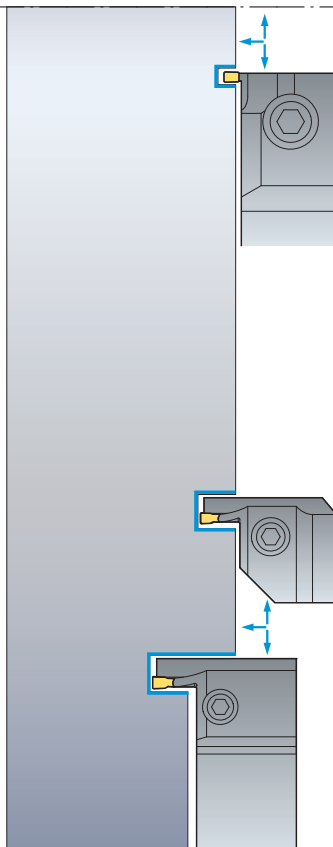
KGEUR/L	MGEUR/L	TBH	K Notch	PH	GH	GFT	DBH	KGEHR/L	MGEHR/L
Width: 2.5 T-MAX: 3.0	Width: 3.0~8.0 T-MAX: 3.0~5.0	Width: 1.25~4.5 T-MAX: 1.5~5.0	Width: 0.75~6.3 T-MAX: 0~6.5	Width: 3.0~5.0 ØD-MAX: 30~50	Width: 1.23~4.28 T-MAX: 1.5~4.0	Width: 1.1~8.0 T-MAX: 2.1~9.0	Width: 3.0~8.0 T-MAX: 14	Width: 2.0~8.0 T-MAX: 17~20	Width: 1.5~8.0 T-MAX: 10~28
KRMN KRGN	MRMN MRGN	TB TB-M	KNG KNGP KNR KNRP KNB	POB	GO GS	GW BF	DC DB	KGGN KGMN KGMR/L KRMN	MGGN MGMN MGMR MRGN MRMN





For internal machining





NFTIH	GFIK	GFIP	IGH	KGIVR/L	MGIVR/L	KGIUR/L	MGIUR/L
Width: 0.75~4.02 T-MAX: 1.3~4.6	Width: 2.0~8.0 T-MAX: 2.0~8.0	Width: 1.1~8.0 T-MAX: 2.1~9.0	Width: 1.25~2.8 T-MAX: 1.5~2.3	Width: 2.0~4.0 T-MAX: 7.0~8.0	Width: 1.5~8.0 T-MAX: 4.0~10	Width: 3.0 T-MAX: 3.0	Width: 3.0~8.0 T-MAX: 3.5~6.5
NFTG NFTF NFTT	GR	GW BF	IG	KGMI KGMN KRMN KGGN	MRMN MGGN MRGN	KRMN KRGN	MRMN








For face grooving







KGEVR/L
Width: 3,0~4,0 T-MAX: 4,0~8,0

KGMN

KGGN

KRMN

KRGN

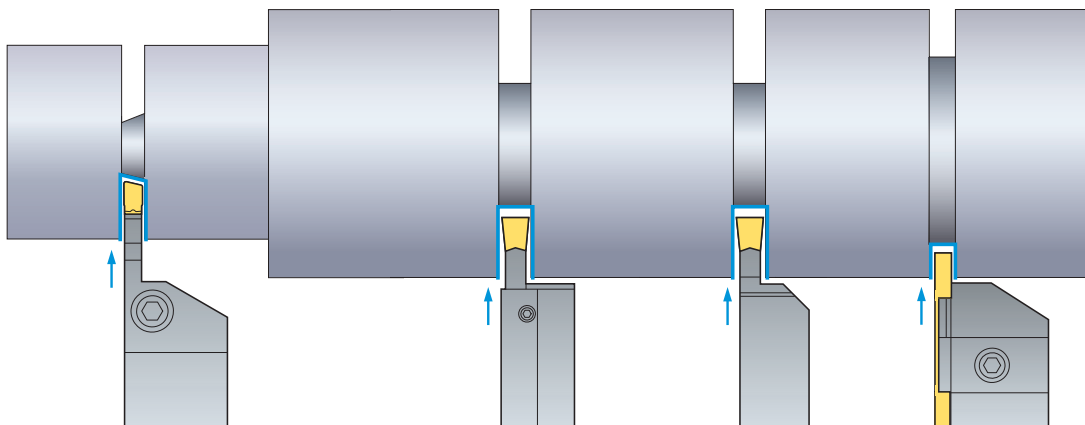
MGEVR/L
Width: 1,5~8,0 T-MAX: 3,0~9,0

MGMN

MGGN

MRMN

MRGN


FGHH/FGVH
Width: 3,0~5,0 T-MAX: 12~25

FGD

FGM

FMM


MGFHR/L, MGFVR/L
Width: 3,0~4,0 T-MAX: 10~15

MGMN

MFMN


KGFHR/L, KGFVR/L
Width: 4,0 T-MAX: 20

KGMN

KRMN

KGGN

KRGN


For parting off






KGEHR/L
Width: 3,0 T-MAX: 20

KGMR/L

MGEHR/L
Width: 2,0~5,0 T-MAX: 10~28

MGMR/L

KSPB
Width: 2,0~6,0 ØD-MAX: 35~125

KSP

SPB-(S)
Width: 2,0~6,0 ØD-MAX: 35~125

SP

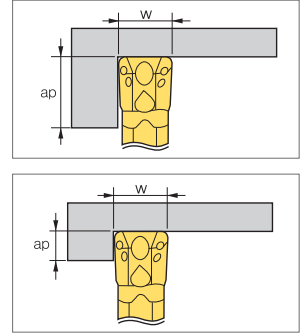
KGTB
Width: 1,5~8,0 ØD-MAX: 26~120

KGMN

KGGN-S-R

PH
Width: 3,0~5,0 ØD-MAX: 30~50

POB

Turning and Grooving

Selection of insert

- Feed rate
 - Decide maximum feed rate after considering the insert's characteristics and machine capabilities ($F_{max} = W \times 0.075$)
 - Max feed rate should not be larger than the corner radius of the insert
 - In grooving applications, chip evacuation problems can be remedied by using step feed methods at small intervals
- Depth of cut
 - The minimum depth of cut should be bigger than corner radius of insert
 - When deciding on the max depth of cut please consider the machine's cutting load
 - Depending on the shape of the insert, deflection of work piece and clearance angle can be changed

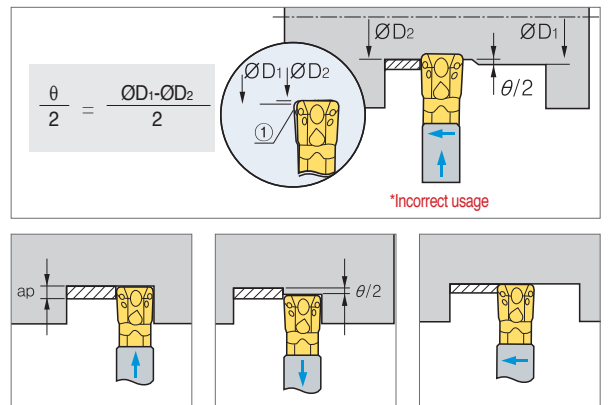


Notice for turning

- KGT/MGT tools are designed to incur side cutting force from its clearance angle; this feature gives you advantage over a standard ISO insert
- The standard MGT insert also provides a "wiper" effect to improve surface roughness

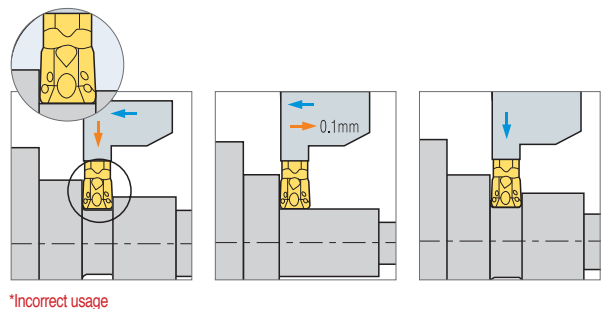
Notice for finishing (offset need final quality)

- After desired diameter is grooved, continuous turning operation might cause some deflection of the workpiece. In these cases follow the given formula, offsetting these factors enables the desired diameter that you want
- To eliminate the difference in the machined diameter by utilizing the clearance angle (which is commonly generated during the final turning operation) follow the directions above when machining. To obtain a good surface roughness without offsetting in an application follows the directions below
 - 1) Groove to the desired diameter
 - 2) Pull the tool backs a total distance of $\theta/2$
 - 3) Continue the external turning operation to desired diameter

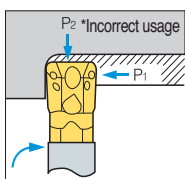


Notice for MGT turning applications

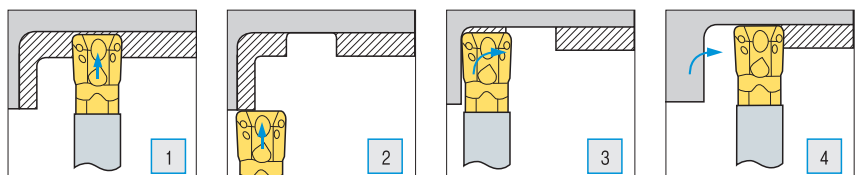
- KGT/MGT tools are available for grooving and turning as a multifunctional tool. When using a M.G.T tool keep in mind that the tool imitates a standard ISO turning application. The application uses a positive clearance angle where a tool's cutting force and depth of cut are all applied in an application. This might create normal wear on the insert, after turning, a grooving process might not meet the desired diameter on the work piece. To off set this, adjust the tool 0.1 mm and return to the original position of the grooving application



Machining workpiece with a radius bigger than the insert's corner radius

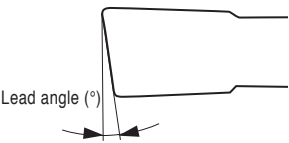

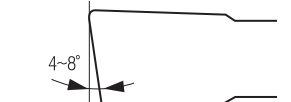
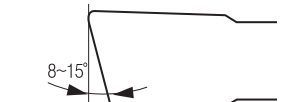


Stabilize your tool pressure. KGT/MGT tools create a cutting load when machining a workpiece with a radius larger than the corner radius of insert (shown in the picture). The unequal cutting force might initially break the insert or holder



Parting off & Grooving

Insert

Lead angle applications	Lead angle 0° (Neutral)	Lead angle 4°~8°	Lead angle 8°~15°
			
<ul style="list-style-type: none"> • 4°- Pipe (Tubing and hollow bar) • 6°- Pipe and solid bar • 8°- Solid bar • 15°- Small diameter Solid bar 	<ul style="list-style-type: none"> • Parting off on solid bar type • Occurring the center stub when parting off • Prevent to be deflected workpiece by cutting direction during parting off • Available for use deep parting depth 	<ul style="list-style-type: none"> • Reduce the center stub when parting off on solid bar type • Reduce the burr when parting off on tubing or hollow bar type 	<ul style="list-style-type: none"> • Parting off on small diameter and hollow bar type • Reduce the burr and center stub when parting off on small diameter solid bar type
<p>※ Available Inserts: MGMR/L□□□ - □□ - LP/RP, KGMR/L□□□ - □□ - PS/PT (Lead angle) (Lead angle)</p>			

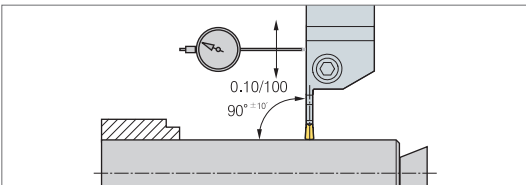
Selection of Insert

- To properly match the insert and cutting condition, the following factors should be considered
 - Width of insert
 - Chip breaker
 - Grade and nose R
- The relationship between the cutting width and cutting depth
 - Neutral type, inserts with a 0-degree lead angle are best when used an applications maximum depth of cut
 - In general alloy steel, the maximum depth of cut = W x 0.8
- Insert with lead angle
 - To reduce burrs, we recommend using insert with a lead angle.
 - Insert that have larger lead angles reduce burrs but will also decreases tool life
 - In the case where burrs are acceptable, we recommend using a neutral type insert



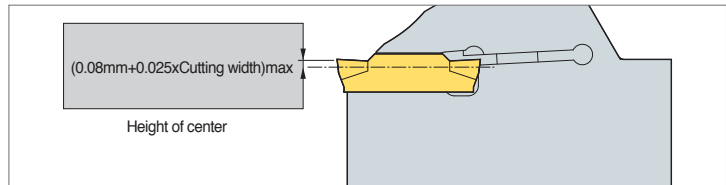
Setting of holders

- The cutting position should be exactly mounted on machined axis in order to create a perpendicular direction or 90 to minimize vibration



Setting of parting off

- The edge height of an insert should be set within ±0.1mm based on the center line
 - Parting off should be done as close to the chuck as possible to minimize vibration



Notice

- Keep a consistent cutting speed and feed
- Use proper amounts of coolant for better performance
- Properly clean the insert pocket before mounting insert

Usage

- If insert is worn, immediately replace with a new insert. This is to prevent the damage on the workpiece
- If the holder seat is worn or damaged replace with a new one immediately for stable clamping
- Do not grind or regrind the holder seat

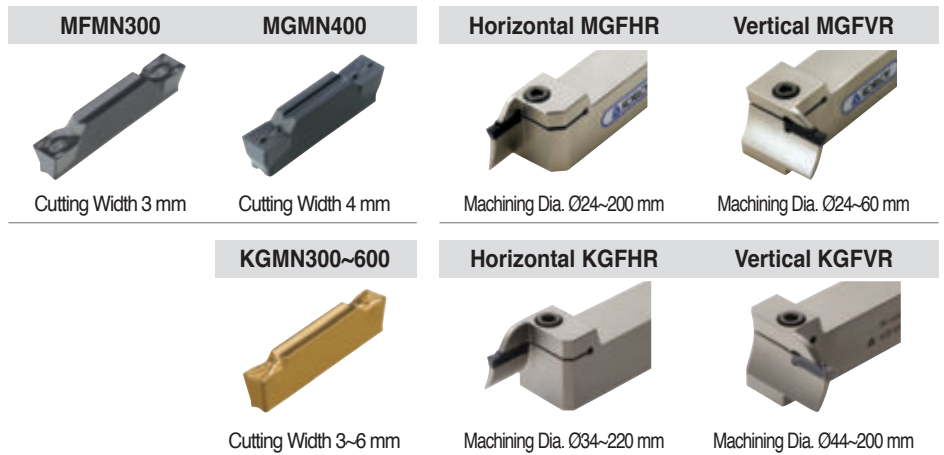
Selection of chip breaker

- Our chip breakers are designed to narrow chips during grooving operations. Narrow chips usually offer the following advantages
- Decreases friction between chips and the workpiece. This usually gives a better surface roughness finish
- With better chip flow, a machinist is able to increase feed rates due to a reduced cutting load

Face grooving tools

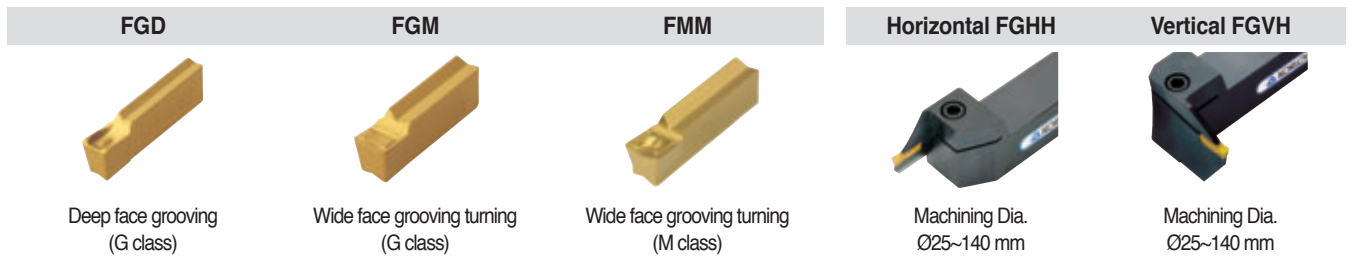
For shallow grooving

- Economical tools utilizing a double ended cutting edge system
- Newly designed chip breakers that help ensure chip control for various face grooving applications
- KORLOY face grooving tools provide various holder line-ups to give you more options and benefits



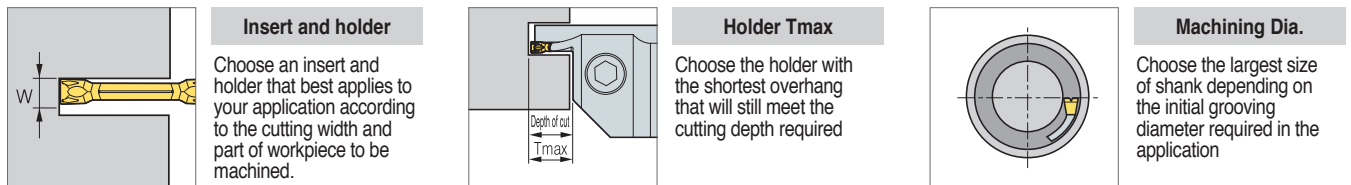
For deep grooving

- These tools are suitable for deep grooving with a single cutting edge (T_{max} 25 mm)
- A variety of chip breakers enable a machinist to apply a wide range of functions in machining
- A variety of holders ensures multiple application ranges



Selection system of holder

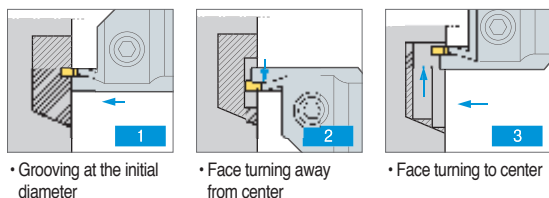
- Follow these 3 simple directions to choose the right insert and holder for your application



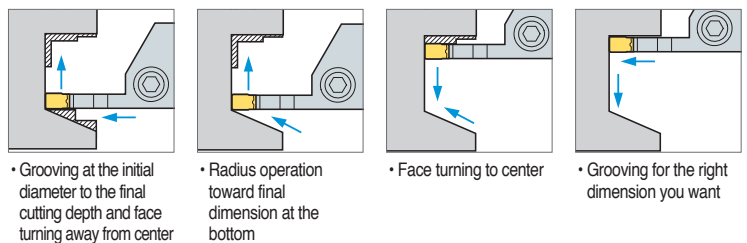
Notice: To minimize chattering, use the shortest holder according to T_{max} .

Optimization of face grooving

Roughing: When face grooving decreases the cutting speed 40% below a normal face turning operation



Finishing: When face grooving decreases the cutting speed 40% below a normal face turning operation



Notice for face grooving

- Before machining, check and adjust the following holder position



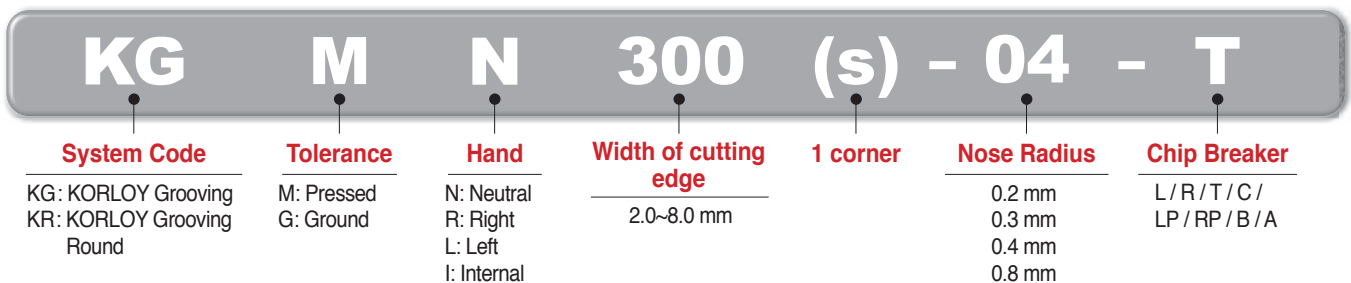
Multi-functional machining with strong clamping system and new technology

KGT

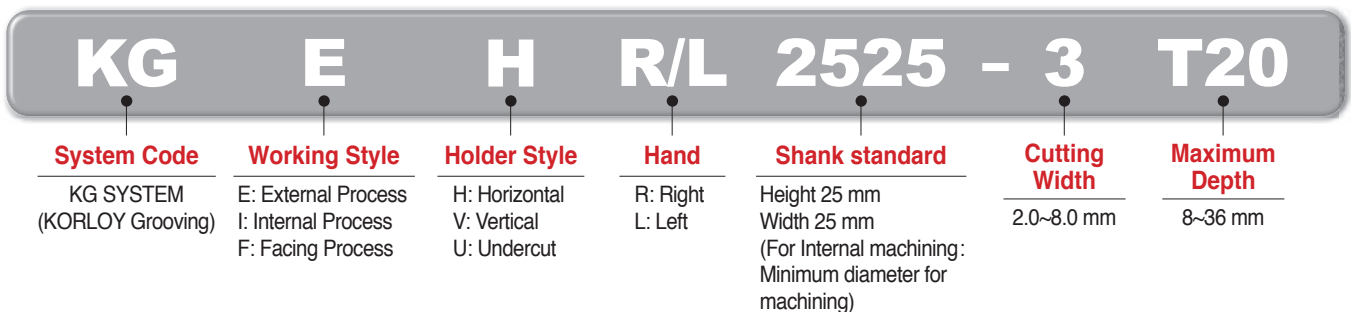
- Double-sided inserts of KGT reduces machining cost
- Strong clamping system ensures stable and accurate machining
- New grade and new technology provide superior tool life
- Various tooling solutions of the KGT improve productivity
- The foreside and clearance face of the KGT insert having cutting edges are optimal for grooving, parting-off, turning and facing with reducing processing time
- Three-dimensional chip breaker ensures excellent chip control in various applications
- The KGT inserts with various chip breakers are available for wide application range
- Special cutting edges are available for quotation

Code system

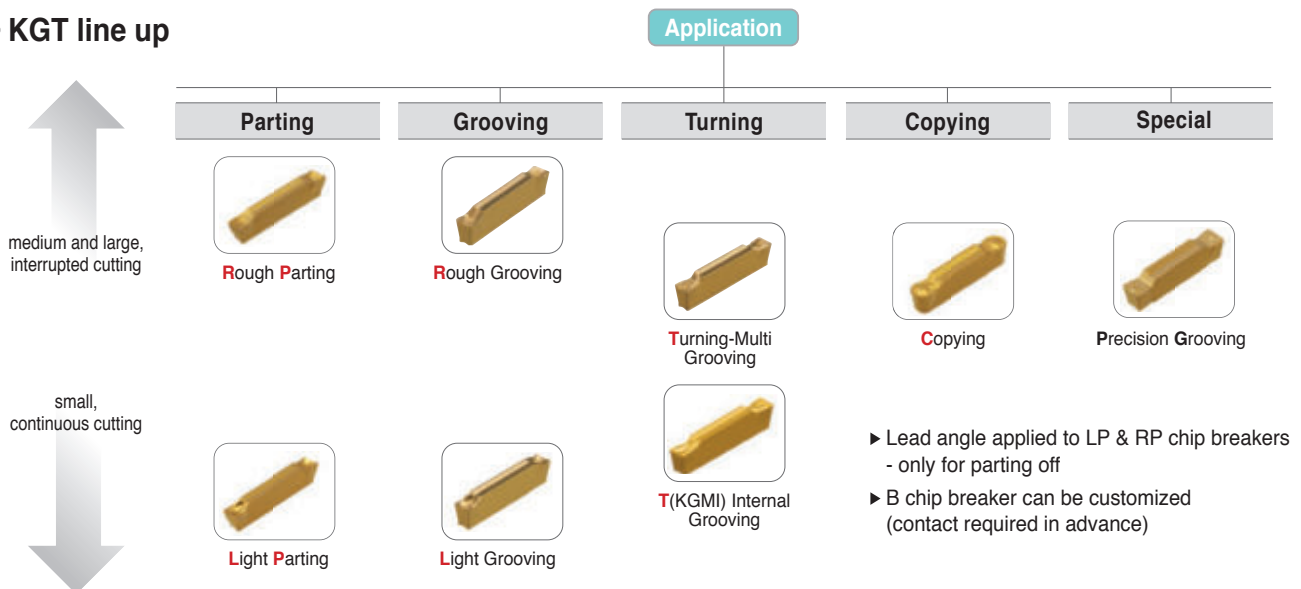
• Insert
























• Holder



KGT line up



Recommended insert

Designation	Geometry	Picture	Application									
			For external machining			For face grooving		For Internal machining		Copying	For relief	Special machining
			Parting	Grooving	Turning	Grooving	Turning	Grooving	Turning	Copying	Relieving	Special
												
KGMN	L Light Grooving		○	◎		○						
	R Rough Grooving		○	◎		○						
	T Turning-Multi Grooving		○	◎	◎	◎	◎					
KGMI	T Internal Grooving							◎	◎			
KRMN	C Copying									◎	◎	
KGMRL	LP Light Parting		◎									
	RP Rough Parting		◎									
KGGN	B Precision Grooving			○								◎
	A Aluminum Grooving		○	◎	○							
KRGN	A Aluminum Profiling									◎	◎	
KRMI	C Copying									◎	◎	

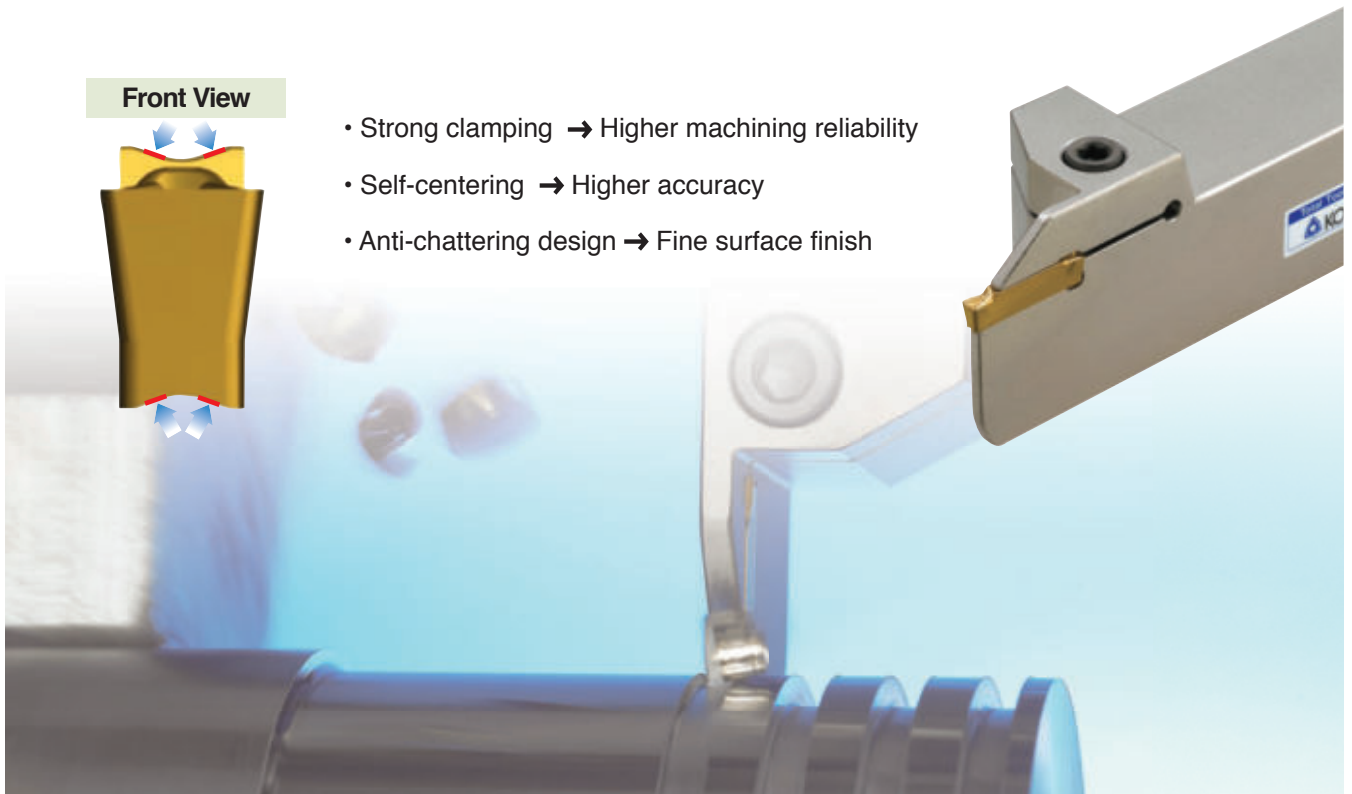
◎ First choice, ○ Second choice

Features

Front View

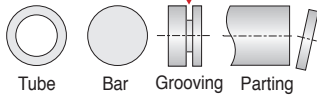
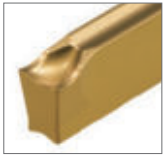


- Strong clamping → Higher machining reliability
- Self-centering → Higher accuracy
- Anti-chattering design → Fine surface finish

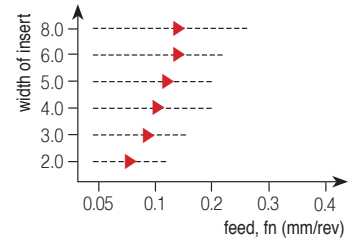


C/B guide

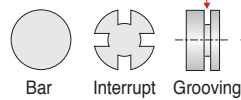
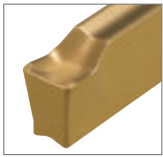
L For **L**ight Grooving



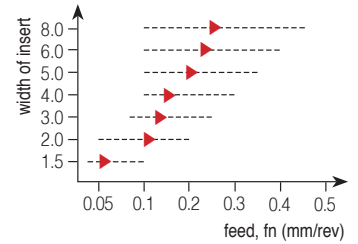
- Sharp cutting edge
- Low feed machining
- Small diameter component
- Low carbon steel
- Alloy steel
- Stainless



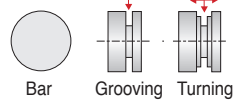
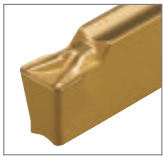
R For **R**ough Grooving



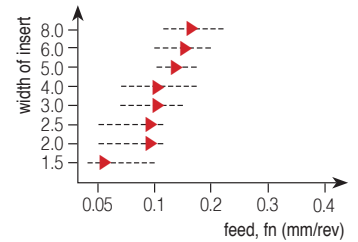
- Strong cutting edge
- High feed machining
- Interrupted cutting
- Carbon steel
- Alloy steel
- Stainless
- Cast iron



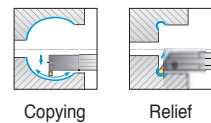
T For **T**urning and Multi Grooving



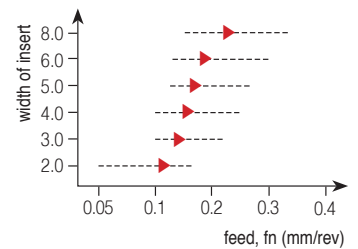
- Sharp cutting edge
- Improved chip control
- Turning & grooving machining
- Carbon steel
- Alloy steel
- Stainless
- Cast iron



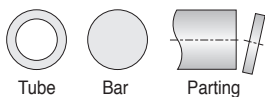
C For **C**opying and Relief



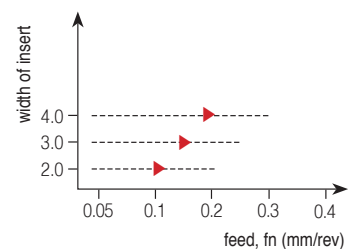
- Improved chip control
- Copying
- Relief
- Carbon steel
- Alloy steel
- Stainless
- Cast iron



LP For **L**ight **P**arting

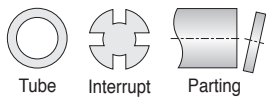
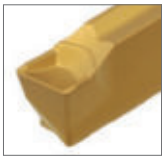


- Sharp cutting edge
- Low feed machining
- Small diameter component
- Right/left handed
- Low carbon steel
- Carbon steel
- Alloy steel
- Stainless



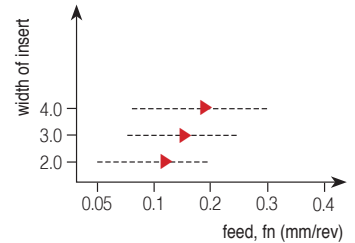
C Technical Information for KGT Series

RP For Rought Parting

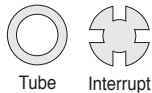


- Strong cutting edge
- High feed machining
- Interrupted cutting
- Right/left handed

- Carbon steel
- Alloy steel
- Cast iron

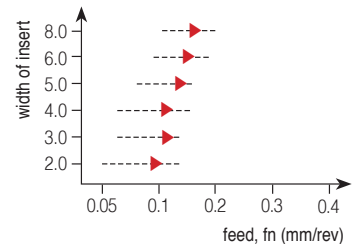


B For Precision Grooving



- Ground insert
- Precise tolerance
- Various cutting edge length, Nose R

- Carbon steel
- Alloy steel
- Stainless
- Cast iron

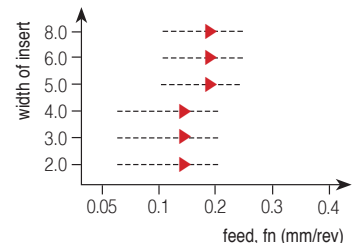


A For Aluminium Grooving



- Sharp cutting edge
- Precise tolerance

- Aluminum alloy
- Copper alloy



Grades for recommended application range

Workpiece	Grade	Order of recommended grade	Recommended cutting speed (m/min)						
			50	100	150	200	800		
P Steel	PC5300	1		70	120				
	PC3035	2		70	130				
	NC3225	3			130	220			
	NC5330	4			120	200			
	M Alloy Steel	PC5300	1		60	105			
		PC3035	2		60	110			
		NC3225	3			130	200		
		NC5330	4			90	180		
K Cast iron	PC5300	1		55	90				
	NC5330	2			95	160			
N Non-ferrous metal	H01	1				200	790		
S HRSA	PC5300	1	20	35					



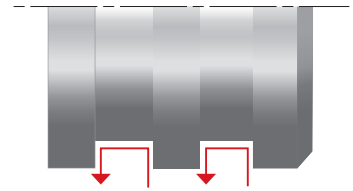
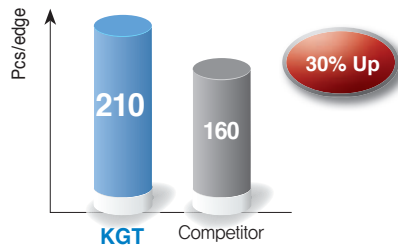
Performance evaluation

Multi-function machining

Turning + Grooving repetition

Optimized geometry for turning + grooving - High efficiency.

- **Workpiece** SM45C
- **Cutting condition**
 - vc = 170 (m/min)
 - fn = 0.15 (mm/rev)
 - ap = 2 mm
 - W = 3 mm
 - wet
- **Designation** KGMN300-04-T (PC5300)

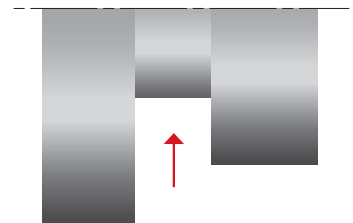
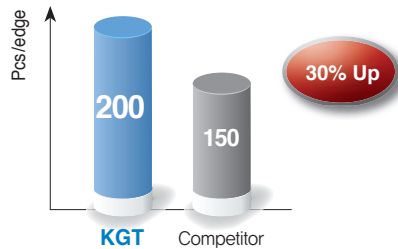


Grooving

Shoulder Grooving

Tough geometry for interrupted and deep grooving.

- **Workpiece** SUS304
- **Cutting condition**
 - vc = 120 (m/min)
 - fn = 0.12 (mm/rev)
 - ap = 5 mm
 - W = 4 mm
 - wet
- **Designation** KGMN400-03-R (PC5300)

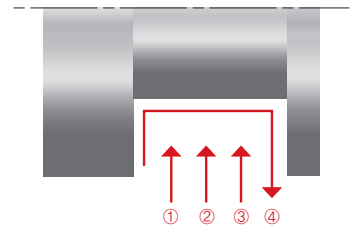
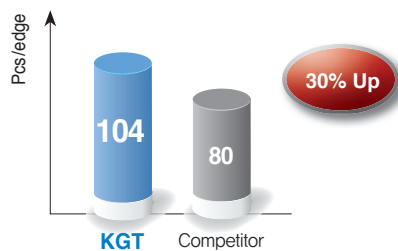


Shaft machining

Grooving (Roughing) & Turning (Finishing)

Excellent chip control for higher efficiency.

- **Workpiece** SCM440
- **Cutting condition**
 - vc = 150 (m/min)
 - fn = 0.15 (mm/rev)
 - ap = 5 mm
 - W = 3 mm x 3
 - wet
- **Designation** KGMN300-04-T (PC5300)

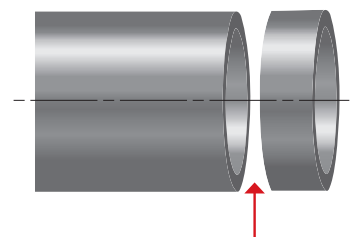
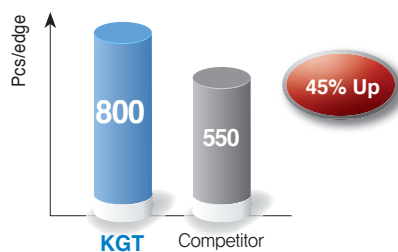


Parting off


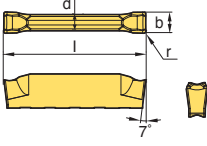

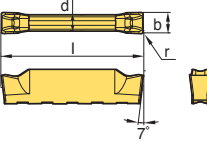

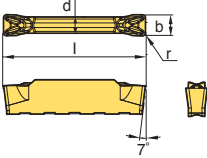

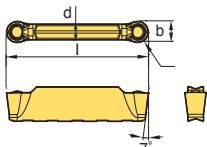

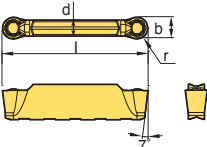
Pipe Parting-off

Exclusive parting-off chip breaker for longer tool life. / Sharp geometry for less burr.

- **Workpiece** SUS304
- **Cutting condition**
 - vc = 140 (m/min)
 - fn = 0.15 (mm/rev)
 - ap = 2 mm
 - W = 3 mm
 - wet
- **Designation** KGMR300-6D-LP (PC5300)



Insert


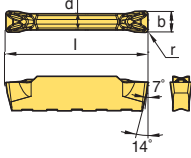

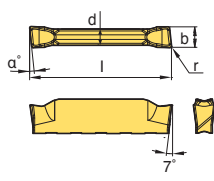

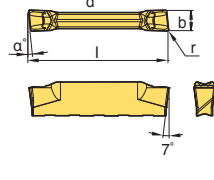

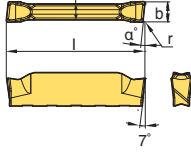

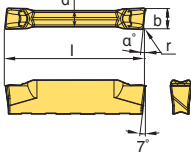

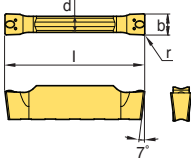
Application	Picture	Designation	Coated						Dimensions (mm)					Configuration	Page
			NC3225	NC5330	NC6315	PC3035	PC5300	PC9030	b	r	l	d	α°		
Grooving		KGMN 200-02-L	●	●		●	●	●	2.0	0.2	20	1.7	-		C14~21 C23
		300-02-L	●	●		●	●	●	3.0	0.2	20	2.3	-		
		400-02-L	●	●		●	●	●	4.0	0.2	20	3.3	-		
		500-03-L	●	●		●	●		5.0	0.3	25	4.1	-		
		600-03-L	●	●			●		6.0	0.3	25	5.1	-		
Grooving - Parting off		KGMN 150-015-R	●	●			●		1.5	0.15	16	1.2	-		C14~21 C23
		200-02-R	●	●		●	●	●	2.0	0.2	20	1.7	-		
		300-02-R	●	●		●	●	●	3.0	0.2	20	2.3	-		
		400-03-R	●	●		●	●	●	4.0	0.3	20	3.3	-		
		500-03-R		●			●		5.0	0.3	25	4.1	-		
		600-03-R		●			●		6.0	0.3	25	5.1	-		
		800-04-R		●			●		8.0	0.4	30	6.1	-		
Grooving - Turning		KGMN 150-015-T	●	●	●		●		1.5	0.15	16	1.2	-		C14~21 C23
		200-02-T	●	●	●	●	●	●	2.0	0.2	20	1.7	-		
		250-02-T	●	●			●		2.5	0.2	20	2.0	-		
		300-02-T	●	●	●	●	●	●	3.0	0.2	20	2.3	-		
		04-T	●	●	●	●	●	●	3.0	0.4	20	2.3	-		
		400-04-T	●	●	●	●	●	●	4.0	0.4	20	3.3	-		
		08-T	●	●	●	●	●	●	4.0	0.8	20	3.3	-		
		500-04-T	●	●	●	●	●	●	5.0	0.4	25	4.1	-		
		08-T	●	●	●	●	●	●	5.0	0.8	25	4.1	-		
		600-04-T	●	●	●	●	●	●	6.0	0.4	25	5.1	-		
		08-T	●	●	●	●	●		6.0	0.8	25	5.1	-		
800-08-T	●		●	●	●		8.0	0.8	30	6.1	-				
Relief Profiling		KRMN 200-C	●	●	●	●	●		2.0	1.0	20	1.7	-		C14~22
		300-C	●	●	●	●	●		3.0	1.5	20	2.2	-		
		400-C	●	●	●	●	●		4.0	2.0	20	3.2	-		
		500-C	●	●	●	●	●		5.0	2.5	25	4.0	-		
		600-C	●	●	●	●	●		6.0	3.0	25	5.0	-		
		800-C	●	●	●		●		8.0	4.0	30	6.0	-		
Profiling		KRMI 200-C							2.0	1.0	20	1.7	-		C23
		300-C							3.0	1.5	20	2.2	-		
		400-C							4.0	2.0	20	3.2	-		

• You can grind the chip breaker, 'B' as any shape you want. If you want any special shape of chip breaker, please contact your distributor.

● : Stock item



Insert


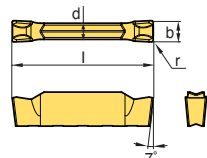

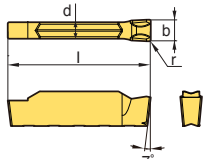

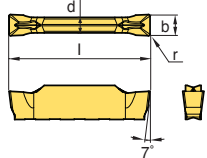

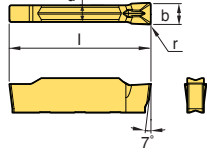

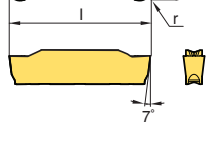
Application	Picture	Designation	Coated					Uncoated		Dimensions (mm)					Configuration	Page
			NC3215	NC3225	NC5330	NC6315	PC5300	PC9030	H01	H05	b	r	l	d		
Grooving - Internal		KGMI 200-02-T					●			2.0	0.2	20	1.7	-		C23
		300-04-T					●			3.0	0.4	20	2.3	-		
		400-04-T					●			4.0	0.4	20	3.3	-		
Parting off (Right handed)		KGMR 200-6D-LP			●		●			2.0	0.2	20	1.7	6		C14 C16
		8D-LP								2.0	0.2	20	1.7	8		
		15D-LP			●		●			2.0	0.2	20	1.7	15		
		300-6D-LP			●		●			3.0	0.2	20	2.3	6		
		15D-LP			●		●			3.0	0.2	20	2.3	15		
		400-4D-LP			●		●			4.0	0.3	20	3.3	4		
		15D-LP			●		●			4.0	0.3	20	3.3	15		
500-4D-LP									5.0	0.3	25	4.1	4			
Parting off (Right handed)		KGMR 200-6D-RP			●		●			2.0	0.2	20	1.7	6		C14 C16
		8D-RP								2.0	0.2	20	1.7	8		
		15D-RP			●		●			2.0	0.2	20	1.7	15		
		300-6D-RP			●		●			3.0	0.2	20	2.3	6		
		15D-RP			●		●			3.0	0.2	20	2.3	15		
		400-4D-RP			●		●			4.0	0.3	20	3.3	4		
		15D-RP			●		●			4.0	0.3	20	3.3	15		
500-4D-RP									5.0	0.3	25	4.1	4			
Parting off (Left handed)		KGML 200-6D-LP								2.0	0.2	20	1.7	6		C14 C16
		15D-LP								2.0	0.2	20	1.7	15		
		300-6D-LP								3.0	0.2	20	2.3	6		
		15D-LP								3.0	0.2	20	2.3	15		
		400-4D-LP								4.0	0.2	20	3.3	4		
15D-LP								4.0	0.2	20	3.3	15				
Parting off (Left handed)		KGML 200-6D-RP								2.0	0.2	20	1.7	6		C14 C16
		15D-RP								2.0	0.2	20	1.7	15		
		300-6D-RP								3.0	0.2	20	2.3	6		
		15D-RP								3.0	0.2	20	2.3	15		
		400-4D-RP								4.0	0.2	20	3.3	4		
15D-RP								4.0	0.2	20	3.3	15				
Grooving (Ground insert)		KGGN 265-015-B								2.65	0.15	20	2.3	-		C14
		300-020-B								3.0	0.20	20	2.3	-		
		040-B								3.0	0.40	20	2.3	-		
		315-015-B								3.15	0.15	20	2.3	-		
		400-040-B								4.0	0.40	20	3.3	-		
		080-B								4.0	0.80	20	3.3	-		
		415-015-B								4.15	0.15	20	3.3	-		
		478-055-B								4.78	0.55	25	4.1	-		
		500-080-B								5.0	0.80	25	4.1	-		
		515-015-B								5.15	0.15	25	4.1	-		
		600-080-B								6.0	0.80	25	5.1	-		
		120-B								6.0	1.20	25	5.1	-		
800-080-B								8.0	0.80	30	6.1	-				
120-B								8.0	1.20	30	6.1	-				

• You can grind the chip breaker, 'B' as any shape you want. If you want any special shape of chip breaker, please contact your distributor.

•: Stock item



Insert

Application	Picture	Designation	Coated						Uncoated		Dimensions (mm)					Configuration	Page
			NC3215	NC3225	NC5330	NC6315	PC5300	PC9030	H01	H05	b	r	l	d	α°		
Grooving · Parting off (Ground Insert)		KGGN 200-02-R								2.0	0.2	20	1.7	-		C14~21	
		300-02-R								3.0	0.2	20	2.3	-			
		400-03-R								4.0	0.3	20	3.3	-			
		500-03-R								5.0	0.3	25	4.1	-			
		600-03-R								6.0	0.3	25	5.1	-			
		800-04-R								8.0	0.4	30	6.1	-			
Grooving · Parting off (Single Insert)		KGGN 200S-02-R								2.0	0.2	19.9	1.7	-		C24	
		300S-02-R					●			3.0	0.2	19.9	2.3	-			
		400S-03-R					●			4.0	0.3	19.9	3.3	-			
		500S-03-R					●			5.0	0.3	24.9	4.1	-			
		600S-03-R					●			6.0	0.3	24.9	5.1	-			
		800S-04-R					●			8.0	0.4	24.9	6.1	-			
Aluminum Grooving		KGGN 200-02-A						●		2.0	0.2	20	1.7	-		C24	
		300-02-A						●		3.0	0.2	20	2.3	-			
		400-04-A						●		4.0	0.4	20	3.3	-			
		500-04-A						●		5.0	0.4	25	4.1	-			
		600-04-A						●		6.0	0.4	25	5.1	-			
Aluminum Grooving (Single Insert)		KGGN 200S-02-A								2.0	0.2	20	1.7	-		C24	
		300S-02-A								3.0	0.2	20	2.3	-			
		400S-04-A								4.0	0.4	20	3.3	-			
		500S-04-A								5.0	0.4	25	4.1	-			
		600S-04-A								6.0	0.4	25	5.1	-			
Aluminum Grooving		KRGN 300-A						●		3.0	1.5	20	2.3	-		C14~21	
		400-A						●		4.0	2.0	20	3.3	-			
		500-A						●		5.0	2.5	25	4.1	-			
		600-A						●		6.0	3.0	25	5.1	-			
		800-A						●		8.0	4.0	30	6.1	-			

• You can grind the chip breaker, 'B' as any shape you want. If you want any special shape of chip breaker, please contact your distributor.

● : Stock item

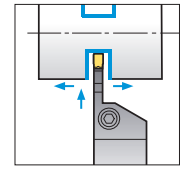
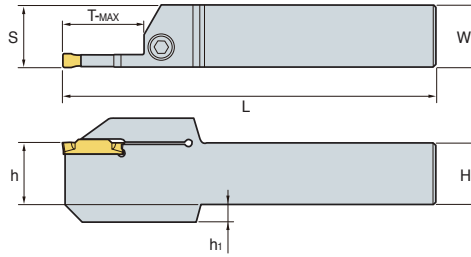
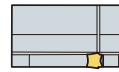
KGEHR/L

For grooving, turning, parting off, and relief machining



KGGN
KGMR/L
KRGN

KGMM
KRMN



• R type insert
(mm)

Designation		H = (h)	W	L	S	h ₁	T-MAX	Inserts	Screw	Wrench
KGEHR/L	1616-1.5-T14	16	16	100	16.2	-	14	KGMM150-□-□	MHA0512	HW40L
	2020-1.5-T14	20	20	125	20.2	-	14			
	2525-1.5-T14	25	25	150	25.2	-	14			
	1212-2-T08	12	12	100	12.2	-	8			
	1616-2-T08	16	16	100	16.2	-	8	KGMM200-□-□ KGMR/L200-□-□ KRMN200-C KGGN200-□-□	MHA0512	HW40L
	2020-2-T08	20	20	125	20.2	-	8			
	2525-2-T08	25	25	150	25.2	-	8			
	1616-2-T12	16	16	100	16.2	-	12			
	2020-2-T12	20	20	125	20.2	-	12			
	2525-2-T12	25	25	150	25.2	-	12			
	1616-2-T17	16	16	100	16.2	-	17			
	2020-2-T17	20	20	125	20.2	-	17			
	2525-2-T17	25	25	150	25.2	-	17			
	1616-2.5-T17	16	16	100	16.3	-	17	KGMM250-□-□	MHA0512	HW40L
	2020-2.5-T17	20	20	125	20.3	-	17			
	2525-2.5-T17	25	25	150	25.3	-	17			
	1616-3-T10	16	16	100	16.4	-	10	KGMM300-□-□ KGMR/L300-□-□ KRMN300-C KGGN300-□-□ KRGN300-□	MHA0512	HW40L
	2020-3-T10	20	20	125	20.4	-	10			
	2525-3-T10	25	25	150	25.4	-	10			
	3232-3-T10	32	32	170	32.4	-	10			
	1616-3-T13	16	16	100	16.4	-	13			
	2020-3-T13	20	20	125	20.4	-	13			
	2525-3-T13	25	25	150	25.4	-	13			
	1616-3-T20	16	16	100	16.4	-	20			
	2020-3-T20	20	20	125	20.4	-	20			
	2525-3-T20	25	25	150	25.4	-	20			
	3232-3-T20	32	32	170	32.4	-	20			
	2525-3-T25	25	25	150	25.4	-	25	KGMM400-□-□ KGMR/L400-□-□ KRMN400-C KGGN400-□-□ KRGN400-□	BHA0616	HW50L
	1616-4-T10	16	16	100	16.4	-	10			
	2020-4-T10	20	20	125	20.4	-	10			
	2525-4-T10	25	25	150	25.4	-	10			
	3232-4-T10	32	32	150	32.4	-	10			
	1616-4-T15	16	16	100	16.4	-	15			
	2020-4-T15	20	20	125	20.4	-	15			
	2525-4-T15	25	25	150	25.4	-	15			
	1616-4-T20	16	16	100	16.4	-	20			
	2020-4-T20	20	20	125	20.4	-	20			
	2525-4-T20	25	25	150	25.4	-	20			
	3232-4-T20	32	32	170	32.4	-	20			
	1616-4-T25	16	16	100	16.4	-	25			
2020-4-T25	20	20	125	20.4	-	25				
2525-4-T25	25	25	150	25.4	-	25				

↻ Applicable inserts C12-C14

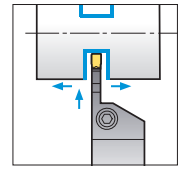
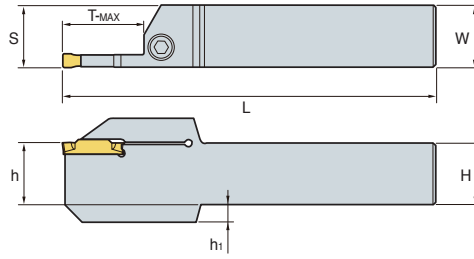
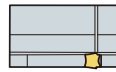


KGEHR/L

For grooving, turning, parting off, and relief machining



KGGN KGMN
KGMR/L KRMN
KRGN



• R type insert
(mm)

Designation		H = (h)	W	L	S	h ₁	T-MAX	Inserts	Screw	Wrench			
KGEHR/L	2020-5-T12	20	20	125	20.5	-	12	KGMN500-□-□ KRMN500-C KGGN500-□-□ KRGN500-□	BHA0616	HW50L			
	2525-5-T12	25	25	150	25.5	-	12						
	2020-5-T15	20	20	125	20.55	-	15						
	2525-5-T15	25	25	150	25.55	-	15						
	3232-5-T15	32	32	170	32.55	-	15						
	2020-5-T20	20	20	125	20.5	-	20						
	2525-5-T20	25	25	150	25.5	-	20						
	3232-5-T20	32	32	170	32.5	-	20						
	2525-5-T32	25	25	150	25.5	7	32				BHA0620	HW50L	
	2020-6-T12	20	20	125	20.5	-	12				KGMN600-□-□ KRMN600-C KGGN600-□-□ KRGN600-□	BHA0616	HW50L
	2525-6-T12	25	25	150	25.5	-	12						
	2525-6-T15	25	25	150	25.55	-	15						
	3232-6-T15	32	32	170	32.55	-	15						
	2020-6-T20	20	20	125	20.5	-	20						
	2525-6-T20	25	25	150	25.5	-	20						
	3232-6-T20	32	32	170	32.5	-	20						
	2525-6-T32	25	25	150	25.5	7	32	BHA0620	HW50L				
	2525-8-T16	25	25	150	26	-	16	KGMN800-□-□ KRMN800-C KGGN800-□-□ KRGN800-□	BHA0616	HW50L			
	3232-8-T16	32	32	170	33.05	-	16						
	2525-8-T25	25	25	150	26	-	25						
3232-8-T25	32	32	170	33	-	25							
2525-8-T36	25	25	150	26	7	36	BHA0620				HW50L		
3232-8-T36	32	32	170	33	-	36							

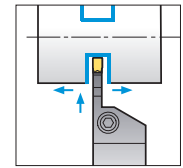
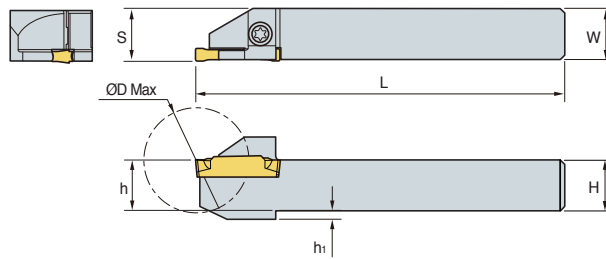
↻ Applicable inserts C12~C14

KGEHR/L-D00A (Auto Tool)

For grooving, turning, parting off machining



KGGN KGMN
KGMR/L KRMN



• R type insert
(mm)

Designation		H = (h)	W	L	S	h ₁	ØD Max	Inserts	Screw	Wrench
KGEHR/L	1010-2-D20A	10	10	125	10.2	2	20	KGMN200-□-□ KGMR/L200-□-□ KRMN200-C KGGN200-□-□	ETNA0412	TW15L
	1212-2-D25A	12	12	125	12.2	2	25			
	1414-2-D25A	14	14	125	14.2	-	25			
	1616-2-D32A	16	16	125	16.2	-	32	KGMN300-□-□ KGMR/L300-□-□ KRMN300-C KGGN300-□-□		
	1212-3-D25A	12	12	125	12.4	2	25			
	1616-3-D32A	16	16	125	16.4	-	32			

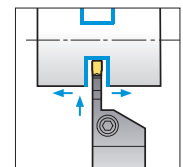
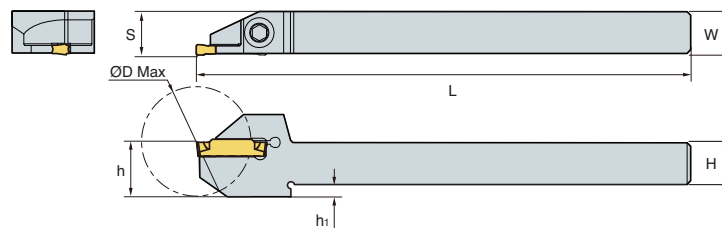
↻ Applicable inserts C12~C14

KGEHR/L-D00B (Auto Tool)

For grooving, turning, parting off machining



KGGN KGMN
KRMN KGMR/L



• R type insert
(mm)

Designation		H = (h)	W	L	S	h ₁	ØD Max	Inserts	Screw	Wrench
KGEHR/L	1010-2-D30B	10	10	140	10.2	6.6	30	KGMN200-□-□ KGMR/L200-□-□ KRMN200-C KGGN200-□-□	MHA0512	HW40L
	1212-2-D25B	12	12	140	12.5	3.5	25			
	1212-2-D30B	12	12	140	12.2	3.5	30			
	1616-2-D25B	16	16	140	16.2	-	25			
	1616-2-D32B	16	16	140	16.2	-	32	KGMN300-□-□ KGMR/L300-□-□ KRMN300-C KGGN300-□-□		
	1212-3-D25B	12	12	140	12.4	3.5	25			
	1212-3-D32B	12	12	140	12.4	3.5	32			
	1616-3-D25B	16	16	140	16.4	-	25			
1616-3-D32B	16	16	140	16.4	-	32				

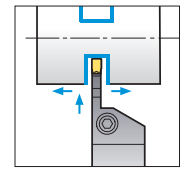
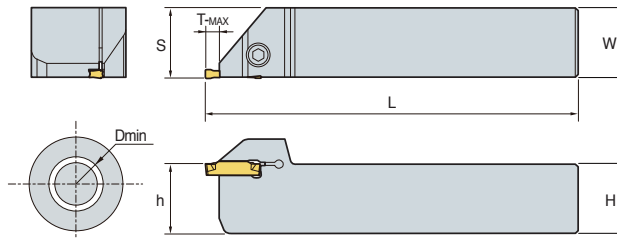
↻ Applicable inserts C12~C14

KGEHR/L-T00

For grooving, turning, face grooving machining



KG MN KR MN
KG GN KR GN



• R type insert
(mm)

Designation	H = (h)	W	L	S	ØD Min	T-MAX	Inserts	Screw	Wrench
KGEHR/L 1616-3-T00	16	16	100	16.4	80	4.8	KG MN300-□-□ KR MN300-C KG GN300-□-□ KR GN300-□	MHA0512	HW40L
	20	20	125	20.4	80	4.8			
	25	25	150	25.4	80	4.8			
1616-4-T00	16	16	100	16.4	80	4.8	KG MN400-□-□ KR MN400-C KG GN400-□-□ KR GN400-□	BHA0616	HW50L
	20	20	125	20.4	80	4.8			
	25	25	150	25.4	80	4.8			
2020-6-T00	20	20	125	20.5	80	6.0	KG MN600-□-□ KR MN600-C KG GN600-□-□ KR GN600-□	BHA0616	HW50L
	25	25	150	25.5	80	6.0			

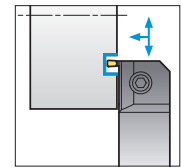
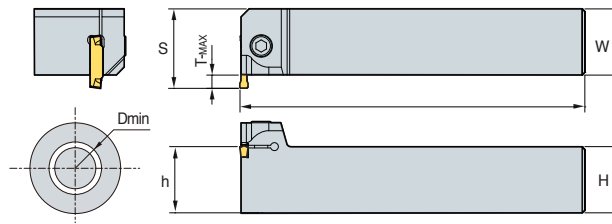
↻ Applicable inserts C12~C14

KGEVR/L-T00

For grooving, turning, face grooving machining



KGMN KRMN
KRGN KGGN



• R type insert

(mm)

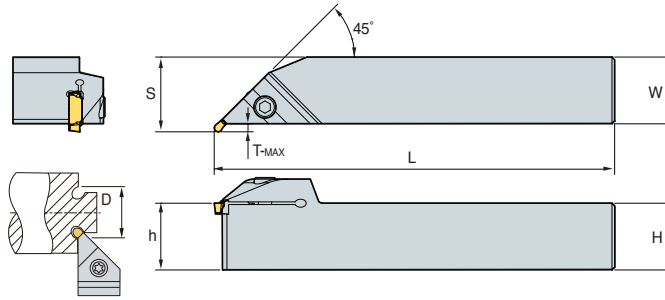
Designation	H = (h)	W	L	S	ØD Min	T-MAX	Inserts	Screw	Wrench	
KGEVR/L 2020-1.5 -T00	20	20	125	23.5	120	3	KGMN150-□-□	MHA0512	HW40L	
	2525-1.5 -T00	25	25	150	28.5	120				3
	3232-1.5 -T00	32	32	170	35.5	120				3
2020-2 -T00	20	20	125	23.5	120	3	KGMN200-□-□ KRMN200-C KGGN200-□-□-□	MHA0512	HW40L	
	2525-2 -T00	25	25	150	28.5	120				3
	3232-2 -T00	32	32	170	35.5	120				3
2020-2.5 -T00	20	20	125	24.5	80	4	KGMN250-□□	MHA0512	HW40L	
	2525-2.5 -T00	25	25	150	29.5	80				4
	3232-2.5 -T00	32	32	170	36.5	80				4
2020-3-T00	20	20	125	25	80	4.8	KGMN300-□-□ KRMN300-C KGGN300-□-□ KRGN300-□	MHA0512	HW40L	
	2525-3-T00	25	25	150	30	80				4.8
	3232-3 -T00	32	32	170	37	80				4.8
2020-4-T00	20	20	125	25	80	4.8	KGMN400-□-□ KRMN400-C KGGN400-□-□ KRGN400-□	BHA0616	HW50L	
	2525-4-T00	25	25	150	30	80				4.8
	3232-4 -T00	32	32	170	37	80				4.8
2020-5 -T00	20	20	125	29.5	60	6	KGMN500-□-□ KRMN500-C KGGN500-□-□ KRGN500-□	BHA0616	HW50L	
	2525-5 -T00	25	25	150	31.5	60				6
	3232-5 -T00	32	32	170	38.5	60				6
2020-6 -T00	20	20	125	26.5	60	6	KGMN600-□-□ KRMN600-C KGGN600-□-□ KRGN600-□	BHA0616	HW50L	
	2525-6-T00	25	25	150	31.5	80				6
	3232-6 -T00	32	32	170	38.5	60				6
2525-8 -T00	25	25	150	33.5	50	8	KGMN800-□-□ KRMN800-C KGGN800-□-□ KRGN800-□	BHA0616	HW50L	
	3232-8 -T00	32	32	170	38.5	50				8

↻ Applicable inserts C12~C14

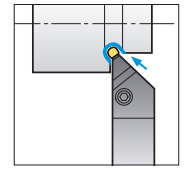
KGEUR/L



KRMN
KRGN



For relief machining



• R type insert
(mm)

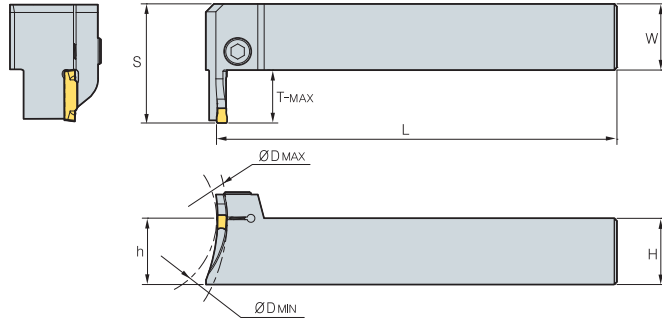
Designation	H = (h)	W	L	S	ØD Min	T-MAX	Inserts	Screw	Wrench	
KGEUR/L 1616-3	16	16	100	19	40	2.8	KRMN300-C KRGN300-□	MHA0512	HW40L	
	2020-3	20	20	125	23	40				2.8
	2525-3	25	25	150	28	40				2.8
	3232-3	32	32	170	35	40				2.8
1616-4	16	16	100	19	40	2.8	KRMN400-C KRGN400-□	BHA0616	HW50L	
	2020-4	20	20	125	23	40				2.8
	2525-4	25	25	150	28	40				2.8
	3232-4	32	32	170	35	40				2.8
2020-5	20	20	125	23.5	50	3.3	KRMN500-C KRGN500-□	BHA0616	HW50L	
	2525-5	25	25	150	28.5	50				3.3
	3232-5	32	32	170	35.5	50				3.3
2020-6	20	20	125	23.5	50	3.3	KRMN600-C KRGN600-□	BHA0616	HW50L	
	2525-6	25	25	150	28.5	50				3.3
	3232-6	32	32	170	35.5	50				3.3
2525-8	25	25	150	28.5	65	3.3	KRMN800-C KRGN800-□	BHA0616	HW50L	
	3232-8	32	32	170	35.5	65				3.3

↻ Applicable inserts C12~C14

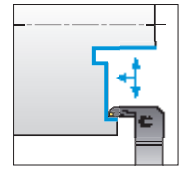
KGFVR/L



KGMN KRMN
KGGN KRGN



For face grooving machining



• R type insert
(mm)

Designation	H = (h)	W	L	S	T-MAX	ØD		Inserts	Screw	Wrench	
						Min	Max				
KGFVR/L 325-34/50-T10	25	25	150	36	10	34	50	KGMN300-□-□ KRMN300-C KGGN300-□-□ KRGN300-□	MHA0512	HW40L	
	44/60-T15	25	25	150	41	15	44				60
	54/85-T15	25	25	150	41	15	54				85
425-32/50-T15	25	25	150	41	15	32	50	KGMN400-□-□ KRMN400-C KGGN400-□-□ KRGN400-□	BHA0616	HW50L	
	42/60-T15	25	25	150	41	15	42				60
	44/70-T20	25	25	150	45.5	20	44				70
	52/85-T15	25	25	150	41	15	52				85
	60/120-T20	25	25	150	45.5	20	60				120
112/200-T20	25	25	150	45.5	20	112	200				
525-50/80-T20	25	25	150	46	20	50	80	KGMN500-□-□ KRMN500-C KGGN500-□-□ KRGN500-□	BHA0616	HW50L	
	70/110-T20	25	25	150	46	20	70				110
	100/150-T20	25	25	150	46	20	100				150
	140/200-T20	25	25	150	46	20	140				200
	200-T20	25	25	150	46	20	200				∞
625-48/85-T20	25	25	150	46	20	48	85	KGMN600-□-□ KRMN600-C KGGN600-□-□ KRGN600-□	BHA0616	HW50L	
	73/150-T20	25	25	150	46	20	73				150
	138/250-T20	25	25	150	46	20	138				250
	250-T20	25	25	150	46	20	250				∞

↻ Applicable inserts C12~C14

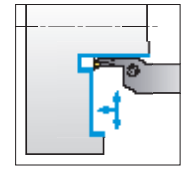
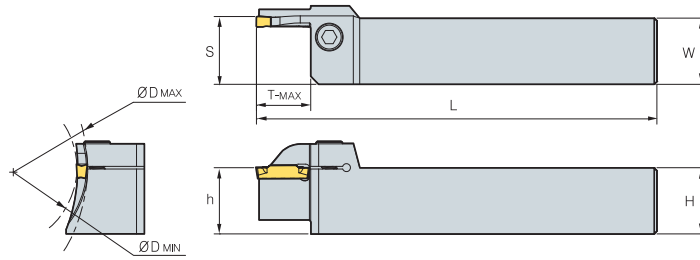
KGFHR/L

For face grooving machining



KG MN
KGGN

KR MN
KRGN



• R type insert
(mm)

Designation	H = (h)	W	L	S	T-MAX	ØD		Inserts	Screw	Wrench	
						Min	Max				
KGFHR/L 320-34/50-T10	20	20	150	20.5	10	34	50	KG MN300-□-□ KR MN300-C KGGN300-□-□ KRGN300-□	MHA0512	HW40L	
	44/70-T15	20	20	150	20.5	15	44				70
	64/100-T15	20	20	150	20.5	15	64				100
325-34/50-T10	25	25	150	25.5	10	34	50	KG MN300-□-□ KR MN300-C KGGN300-□-□ KRGN300-□	MHA0512	HW40L	
	44/70-T15	25	25	150	25.5	15	44				70
	64/100-T15	25	25	150	25.5	15	64				100
420-34/50-T16	20	20	150	20.5	16	34	50	KG MN400-□-□ KR MN400-C KGGN400-□-□ KRGN400-□	BHA0616	HW50L	
	42/70-T16	20	20	150	20.5	16	42				70
	62/120-T16	20	20	150	20.5	16	62				120
	112/200-T16	20	20	150	20.5	16	112				200
425-34/50-T20	25	25	150	25.6	20	34	50	KG MN400-□-□ KR MN400-C KGGN400-□-□ KRGN400-□	BHA0616	HW50L	
	40/60-T10	25	25	150	25.6	10	40				60
	44/70-T20	25	25	150	25.6	20	44				70
	84/92-T20	25	25	150	25.6	20	84				92
	60/120-T20	25	25	150	25.6	20	60				120
	112/200-T20	25	25	150	25.6	20	112				200
200-T20	25	25	150	25.6	20	200	∞	KG MN400-□-□ KR MN400-C KGGN400-□-□ KRGN400-□	BHA0616	HW50L	
	200-T20	25	25	150	25.6	20	200				∞
525-50/80-T15	25	25	150	25.6	15	50	80	KG MN500-□-□ KR MN500-C KGGN500-□-□ KRGN500-□	BHA0616	HW50L	
	50/80-T25	25	25	150	25.6	25	50				80
	70/110-T15	25	25	150	25.6	15	70				110
	70/110-T25	25	25	150	25.6	25	70				110
	100/150-T25	25	25	150	25.6	25	100				150
	140/200-T25	25	25	150	25.6	25	140				200
	190/220-T10	25	25	150	25.6	10	190				200
	200-T25	25	25	150	25.6	25	200				∞
625-170/190-T10	25	25	150	25.6	10	170	190	KG MN600-□-□ KR MN600-C KGGN600-□-□ KRGN600-□	BHA0616	HW50L	
	190/220-T10	25	25	150	25.6	10	190				200

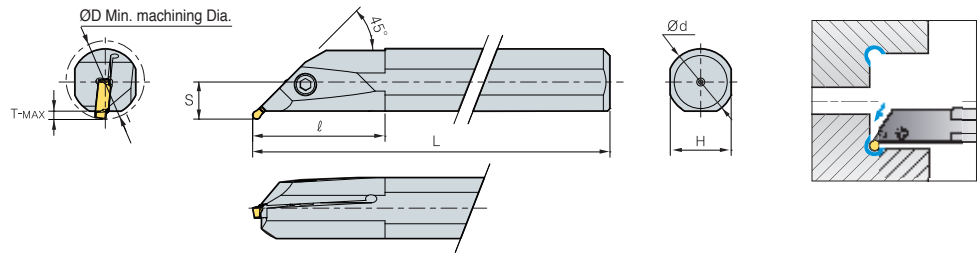
↻ Applicable inserts C12~C14

KGIUR/L

For relief machining



KRMN
KRGN



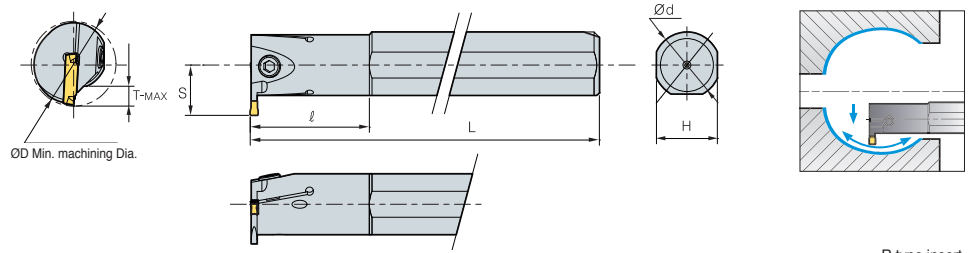
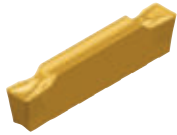
• R type insert
(mm)

Designation	ØD	Ød	L	ℓ	T-MAX	H	S	Inserts	Screw	Wrench	
KGIUR/L 3520-3	35	20	150	45	3.5	18	13	KRMN300-C KRGN300-□	MHA0512	HW40L	
	4025-3	40	25	200	50	3.5	23				15.5
	5032-3	50	32	250	65	3.5	30				19
3520-4	35	20	150	45	3.5	18	13	KRMN400-C KRGN400-□	MHA0512	HW40L	
	4025-4	40	25	200	50	3.5	23				15.5
	5032-4	50	32	250	65	3.5	30				19
4025-5	40	25	200	50	3.5	23	15.5	KRMN500-C KRGN500-□	MHA0512	HW40L	
	5032-5	50	32	250	65	3.5	30				19
4025-6	40	25	200	50	3.5	23	15.5	KRMN600-C KRGN600-□	MHA0512	HW40L	
	5032-6	50	32	250	65	3.5	30				19
4025-8	40	25	200	50	3.5	23	18.5	KRMN800-C	MHA0512	HW40L	
5032-8	50	32	250	65	3.5	30	22	KRGN800-□			

↻ Applicable inserts C12~C14

KGIVR/L

For grooving, turning and profil machining



KGMI
KGGN
KRMN

KGMN
KRMI

• R type insert
(mm)

Designation		ØD	Ød	L	ℓ	T-MAX	H	S	Inserts	Screw	Wrench
KGIVR/L	2016-1.5	20	16	125	35	4	15	12	KGMN150-□-□	MHB0410	HW30L
	2520-1.5	25	20	150	45	6	18	15.5		MHB0410	
	3225-1.5	32	25	200	45	7	23	19		MHA0512	HW40L
	2516-2	25	16	125	35	6.5	15	14	KGMN200-□-T KRMI200-C	MHB0410	HW30L
	2520-2	25	20	150	45	6.5	18	15.5		MHB0512	HW40L
	3225-2	32	25	200	45	7	23	19	KGMN250-□-□	MHB0410	HW30L
	2516-2.5	25	16	125	35	6.5	15	14		MHA0512	HW40L
	2520-2.5	25	20	150	45	6.5	18	15.5		MHB0410	HW30L
	3225-2.5	32	25	200	45	7	23	19	KGMN300-□-T KRMI300-C	MHA0512	HW40L
	2520-3	25	20	150	45	6.5	18	15.5		MHB0410	HW30L
	3225-3	32	25	200	45	7	23	19	KGMN400-□-T KRMI400-C	MHA0512	HW40L
	4032-3	40	32	250	55	7.5	30	22.5		BHA0616	HW50L
	2520-4	25	20	150	45	6.5	18	15.5		MHB0410	HW30L
	3225-4	32	25	200	45	7	23	19	KGMN500-□-□ KRMN500-C	MHA0512	HW40L
	4032-4	40	32	250	55	7.5	30	22.5		BHA0616	HW50L
	3225-5	32	25	200	45	7.5	23	19.5	KGGN500-□-R KGGN500-□-A	MHA0512	HW40L
	4032-5	40	32	250	55	8.5	30	23.5		BHA0616	HW50L
	3225-6	32	25	200	45	7.5	23	19.5	KGMN600-□-□ KRMN600-C	MHA0512	HW40L
	4032-6	40	32	250	55	8.5	30	23.5		BHA0616	HW50L
	4032-8	40	32	250	55	8.5	30	23.5	KGMN800-□-□ KRMN800-C	BHA0616	HW50L
4540-8	45	40	300	70	8.5	37	26.5	KGGN800-□-R		BHA0616	HW50L

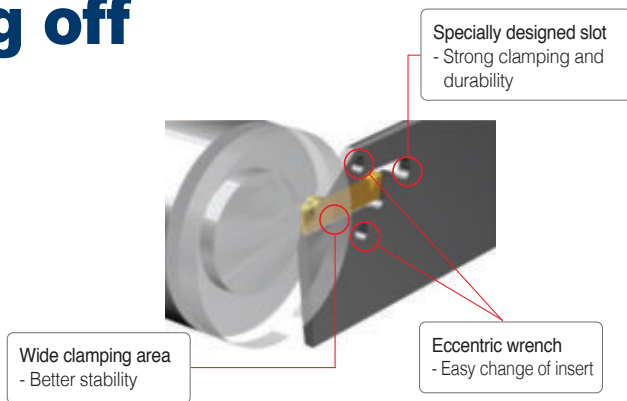
↻ Applicable inserts C12~C14

• 200, 300, 400 inserts : Internal inserts, KGMI or KRMI

KGT Blade for Parting off

Features

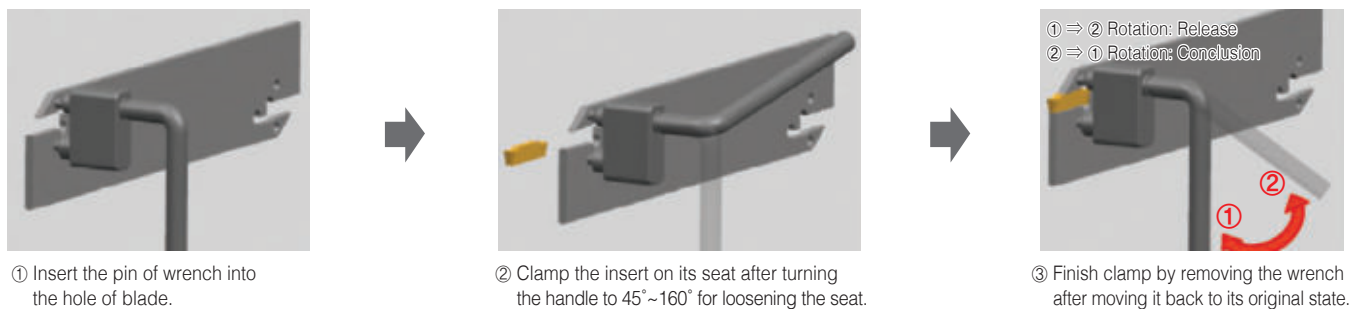
- Parting application with the use of existing KGT inserts
- Economical machining with a double sided insert
- Specially designed slot for strong and stable clamping
- Easy change of insert with the use of exclusive wrench



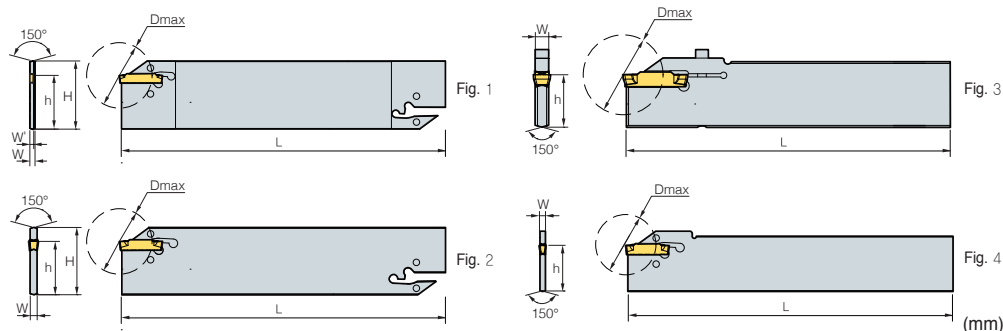
Code system



How to clamp insert



KGTB



Designation	H	W	W'	L	h	ØD Max ⁽²⁾	ØD Max ⁽³⁾	Inserts	Wrench	Fig	
KGTB 1526S	26	2.4	1.0	150	21	-	26	KG□□150-□-□	EW1203 (Separately ordered)	4	
1532	32	2.4	1	150	25	-	26	KG□□150-□-□		1	
2026S	26	2.4	1.8	150	21	50	39	KG□□200-□-□ KG□□200S-□-R ⁽⁴⁾		4	
2032	32	2.4	1.8	150	25	50	39	KG□□200-□-□ KG□□200S-□-R ⁽⁴⁾		1	
3026S	26	2.4	-	150	21	100	39	KG□□300-□-□ KG□□300S-□-R ⁽⁴⁾		4	
3032	32	2.4	-	150	25	100	39	KG□□300-□-□ KG□□300S-□-R ⁽⁴⁾		2	
4026S	26	3.2	-	150	21	100	39	KG□□400-□-□ KG□□400S-□-R ⁽⁴⁾		4	
4032	32	3.2	-	150	25	100	39	KG□□400-□-□ KG□□400S-□-R ⁽⁴⁾		2	
5032	32	4	-	150	25	120	49	KG□□500-□-□ KG□□500S-□-R ⁽⁴⁾		2	
6032	32	5.2	-	150	25	120	49	KG□□600-□-□ KG□□600S-□-R ⁽⁴⁾		2	
8032S⁽¹⁾	32	6.2	-	150	25	80	59	KG□□800-□-□ KG□□800S-□-R ⁽⁴⁾		HW30L	3

➔ Applicable inserts C12~C14

(1) Screw clamping (2) 1 corner use (3) 2 corner use (4) 1 corner insert



Inserts are offered with two edges, for better economical machining

MGT Series

- Inserts are offered with two edges, for better economical machining
- Multi-function operations - Reduce cycle time & increase productivity with the ability to groove, turn, face or copy in an application
- Shorten time & save on tool cost - Korloy's MGT system allows a machinist to apply one tool against many applications, reducing the number of tools
- Flat Cutting Edge - MGT tools have a flat geometry on its cutting edge to ensure excellent surface finishes. Even in high Feed applications by using a wiper function, Korloy ensures excellent surface finishes in roughing operations

Code system












• Insert

MG	M	N	300	-	04	-	T
System Code	Tolerance	Hand	Cutting Edge Width		Nose Radius (Nose R)		Chip Breaker
MG: Multi Grooving MR: Multi Grooving Round	M: Pressed G: Ground	N: Neutral R: Right L: Left I: Internal	1.5~8.0 mm		0.2 mm 0.3 mm 0.4 mm 0.8 mm		L / R / T / M / PS / PT / A

• Holder

MG	E	H	R/L	2525	-	3	T15
System Code	Application	Holder Type	Hand	Shank Size		Cutting Width	Maximum Depth of Cut
MG: Multi Grooving	E: External machining I: Internal machining	H: Horizontal V: Vertical U: Undercut	R: Right L: Left	Height: 25 mm Width: 25 mm (For internal machining: Minimum diameter)		1.5~8.0 mm	15~25 mm

Geometry of chip breaker

MGM(G)N-M  <ul style="list-style-type: none"> · Specially designed chip breaker allows a smoother chip flow versus conventional flat-top geometries through the use of a central chip breaker · Specially placed convex dots assists with chip control in external machining, for a smoother chip flow · Chip breaker designed for turning & grooving applications 	MGMN-G  <ul style="list-style-type: none"> · Specially designed chip breaker allows narrower chips to promote better chip flow · Specifically designed for grooving applications 	MRMN-M  <ul style="list-style-type: none"> · Full radius geometry for applications that require profiling · Available for relief machining 	MFMN300  <ul style="list-style-type: none"> · Specially designed chip breaker allows narrower chips to promote better chip flow · Chip breaker specially designed for face-grooving
MRGN-A  <ul style="list-style-type: none"> · Specially designed high positive geometry, ideal for machining aluminum · The chip breaker's super buffed, high rake angle allows optimal chip flow of aluminum 	MGMR-PS  <ul style="list-style-type: none"> · Sharply designed cutting edge. · Recommended in machining low carbon steel and stainless steel · Specially designed chip breaker allows narrower chips to promote better chip flow. · Able to machine Feed rates and small diameter cutting 	MGMR-PT  <ul style="list-style-type: none"> · Stronger cutting edge with a negative land for tougher applications · Able to machine at Feed rates as high and bar stock · Chip breaker design helps narrows chips for better flow 	MGGN-A  <ul style="list-style-type: none"> · Smooth chip flow · Reduced build up on cutting edge
MGMN-L  <ul style="list-style-type: none"> · Sharp cutting edge · Low cutting resistance · For auto CNC machine · For small Dia. processing 	MGMN-R  <ul style="list-style-type: none"> · Strong cutting edge · For high feed rate processing 	MGMN-T  <ul style="list-style-type: none"> · For turning & grooving · Reduced chip width & smooth chip control by dot designed on the top corner 	



Parting off (MGMN/MGMR/L)

Workpiece	Cutting Speed (vc = m/min)								Feed (fn = mm/rev)				
	CVD				PVD			Uncoated	Cutting width (mm)				
	NC3120	NC3030	NCM325	NC5330	PC8110	PC5300	PC6510	ST30A	2	3	4	5	6
SM□□C	80~180			80~180		80~180			0.02~0.15	0.03~0.20	0.08~0.30	0.10~0.40	0.12~0.50
SCM	70~150	70~150	70~150	70~150		70~150			0.02~0.15	0.03~0.20	0.08~0.30	0.10~0.40	0.12~0.50
GC/GCD				50~100			50~100	50~100	0.05~0.12	0.10~0.25	0.10~0.30	0.10~0.35	0.10~0.40
STS			50~120	50~120	50~120	60~140			0.02~0.10	0.03~0.15	0.08~0.25	0.10~0.35	0.12~0.40
Non-ferrous metal (Al, Copper)								200~450	0.05~0.10	0.05~0.20	0.05~0.25	0.05~0.30	0.05~0.35


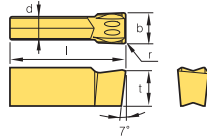

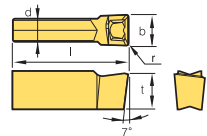

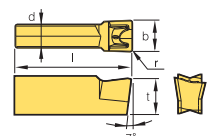

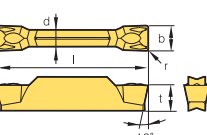

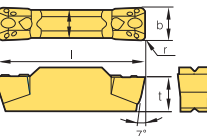

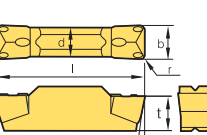

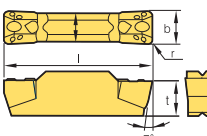
Facing (FGD/FGM/FMM/MFMN/MGMN)

Workpiece	Cutting Speed (vc = m/min)							Feed (fn = mm/rev)		
	CVD				PVD		Uncoated	Cutting width (mm)		
	NC6110	NC3030	NC5330	NC3120	PC215K	PC8110 / PC5300	H01	3	4	5
SM□□C			100~160	100~160				0.05~0.10	0.05~0.12	0.05~0.15
SCM		50~130	50~130	50~130			200~800	0.05~0.10	0.05~0.12	0.05~0.15
GC/GCD	120~150		120~150		120~150			0.05~0.10	0.05~0.12	0.05~0.15
STS			60~150			60~150		0.05~0.10	0.05~0.12	0.05~0.15
Non-ferrous metal (Al, Copper)								0.05~0.15	0.08~0.15	0.08~0.15

Grooving, Turning (MGMN/MRMN)

Workpiece	Cutting Speed (vc = m/min)								Feed (fn = mm/rev)					
	CVD			PVD		Cermet	Uncoated		Cutting width (mm)					
	NC3120	NC3030	NC5330	PC215K	PC5300	CN20	ST30A	ST20	0.5~1.0	1.0~2.0	2~3	3~4	4~5	6~8
SM□□C	80~200		80~200		80~180	80~120		80~120	0.03~0.08	0.04~0.09	0.05~0.1	0.05~0.12	0.05~0.15	0.05~0.2
SCM	80~180	80~180	80~180		80~160	80~120	80~120	80~120	0.03~0.07	0.04~0.08	0.05~0.08	0.05~0.1	0.05~0.12	0.05~0.15
GC/GCD			60~130		60~130				0.03~0.07	0.04~0.08	0.05~0.08	0.05~0.1	0.05~0.10	0.05~0.12
STS			60~100	60~100			60~100		0.03~0.08	0.04~0.09	0.05~0.10	0.05~0.12	0.05~0.12	0.05~0.15
Non-ferrous metal (Al, Copper)				150~300			150~400		0.05~0.12	0.05~0.15	0.05~0.15	0.08~0.15	0.08~0.15	0.10~0.20


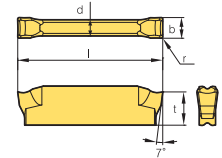

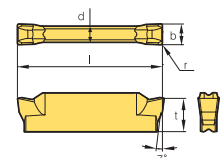

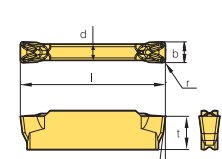

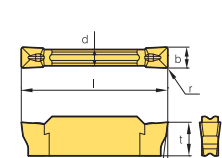
Insert

Application	Picture	Designation	Coated							Uncoated	Dimensions (mm)					Configuration	Page		
			NC3120	NC3225	NC3030	NC5330	NC6315	PC5300	PC8110	PC9030	H01	b	r	l	d			t	
Face Grooving		FGD	300R-03			●						3.0	0.3	15.0	2.0	4.0		C36 C37	
			400R-04			●						4.0	0.4	15.0	3.0	4.5			
			500R-04			●						5.0	0.4	15.0	4.0	5.0			
		FGM	300R-03									3.0	0.3	15.0	2.0	4.0		C36 C37	
			400R-04			●						4.0	0.4	15.0	3.0	4.5			
			500R-04									5.0	0.4	15.0	4.0	5.0			
		FMM	300R-03			●				●		3.0	0.3	15.0	2.0	3.91		C36 C37	
			400R-04			●						4.0	0.4	15.0	3.0	3.96			
			500R-04								●	5.0	0.4	15.0	4.0	4.42			
Face Grooving		MFMN	300			●					3.0	0.2	18.0	2.0	3.0		C35 C41		
Grooving - Turning			300-02-M								3.0	0.2	21.0	2.35	4.83		C30 C32 C34 C41		
			04-M								3.0	0.4	21.0	2.35	4.83				
			08-M								3.0	0.8	21.0	2.35	4.83				
			400-02-M									4.0	0.2	21.0	3.3			4.83	
			04-M								4.0	0.4	21.0	3.3	4.83				
			08-M								4.0	0.8	21.0	3.3	4.83				
			500-02-M									5.0	0.2	26.0	4.1			5.82	
			04-M								5.0	0.4	26.0	4.1	5.82				
			08-M								5.0	0.8	26.0	4.1	5.82				
			600-02-M									6.0	0.2	26.0	5.0			5.81	
			04-M								6.0	0.4	26.0	5.0	5.81				
			08-M								6.0	0.8	26.0	5.0	5.81				
Grooving		MGMN	150-G		●	●			●	●	1.5	0.15	16.0	1.2	3.5		C30 C32 C34 C41		
			200-G	●	●	●				●	●	2.0	0.2	16.0	1.6			3.5	
			250-G		●	●					●	●	2.5	0.2	18.5			2.0	3.85
			300-G	●	●	●	●			●	●	3.0	0.3	21.0	2.35			4.83	
			400-G	●						●	●	4.0	0.3	21.0	3.3			4.83	
			500-G									5.0	0.5	26.0	4.1			5.82	
			600-G									6.0	0.8	26.0	5.0			5.81	
Grooving - Turning		MGMN	200-M	●	●	●	●		●	●	2.0	0.2	16.0	1.6	3.5		C30 C32 C34 C41		
			250-M	●	●	●			●	●	2.5	0.2	18.5	2.0	3.85				
			300-02-M				●					3.0	0.2	21.0	2.35			4.83	
			300-M	●	●	●	●	●	●	●	●	3.0	0.4	21.0	2.35			4.83	
			350-03-M									3.5	0.3	21.0	2.9			4.83	
			400-02-M									4.0	0.2	21.0	3.3			4.83	
			400-M	●	●	●	●	●	●	●	●	4.0	0.4	21.0	3.3			4.83	
			500-04-M				●					5.0	0.4	26.0	4.1			5.82	
			500-M	●	●	●	●	●			●	5.0	0.8	26.0	4.1			5.82	
			600-M	●	●	●	●	●				6.0	0.8	26.0	5.0			5.81	
800-M				●					8.0	0.8	31.0	6.0	6.52						

● : Stock item




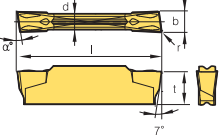

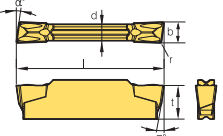

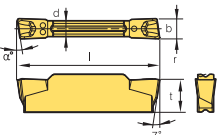

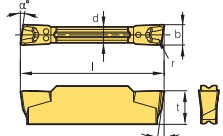

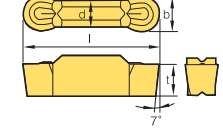

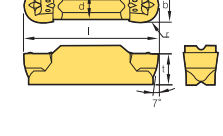
Insert

Application	Picture	Designation	Coated							Uncoated		Dimensions (mm)						Configuration	Page
			NC3120	NC3225	NC3030	NC5330	NC6315	PC5300	PC8100	PC9030	H01	H05	b	r	l	d	t		
Grooving		MGMN 200-02-L										2.0	0.2	16	1.6	3.5	-		C30 C32 C34 C35
		04-L										2.0	0.4	20	1.7	3.5	-		
		250-02-L										2.5	0.2	18.5	2.0	3.85	-		
		300-02-L							●			3.0	0.2	21	2.35	4.83	-		
		04-L										3.0	0.4	20	2.3	4.83	-		
		400-02-L							●			4.0	0.2	21	3.3	4.83	-		
		04-L										4.0	0.4	20	3.3	4.83	-		
		500-03-L										5.0	0.3	26	4.1	5.82	-		
04-L							●			5.0	0.4	26	4.1	5.82	-				
Grooving · Parting off		MGMN 150-015-R										1.5	0.15	16	1.2	3.5	-		C30 C32 C34 C35
		200-02-R										2.0	0.2	16	1.6	3.5	-		
		04-R										2.0	0.4	20	1.7	3.5	-		
		250-02-R										2.5	0.2	18.5	2.0	3.85	-		
		300-02-R				●			●			3.0	0.2	21	2.35	4.83	-		
		04-R										3.0	0.4	20	2.3	4.83	-		
		400-02-R				●			●			4.0	0.2	21	3.3	4.83	-		
		04-R										4.0	0.4	20	3.3	4.83	-		
		500-04-R				●			●			5.0	0.4	26	4.1	5.82	-		
		08-R										5.0	0.4	26	4.1	5.82	-		
600-04-R										6.0	0.4	26	5.0	5.81	-				
08-R										6.0	0.8	26	5.0	5.81	-				
Grooving · Turning		MGMN 150-015-T										1.5	0.15	16	1.2	3.5	-		C30 C32 C34 C35
		200-T										2.0	0.2	16	1.6	3.5	-		
		300-T				●			●			3.0	0.4	21	2.35	4.83	-		
		400-T				●			●			4.0	0.4	21	3.3	4.83	-		
		500-04-T										5.0	0.4	26	4.1	5.82	-		
		500-T							●			5.0	0.8	26	4.1	5.82	-		
600-08-T										6.0	0.8	26	5.0	5.81	-				
Grooving		MGMN 300-02-A										3.0	0.2	21	2.35	4.83	-		C28 C30 C32 C41
		04-A										3.0	0.4	21	2.35	4.83	-		
		08-A										3.0	0.8	21	2.35	4.83	-		
		400-02-A										4.0	0.2	21	3.3	4.83	-		
		04-A										4.0	0.4	21	3.3	4.83	-		
		08-A										4.0	0.8	21	3.3	4.83	-		
		500-02-A										5.0	0.2	26	4.1	5.82	-		
		04-A										5.0	0.4	26	4.1	5.82	-		
08-A										5.0	0.8	26	4.1	5.82	-				

● : Stock item



Insert

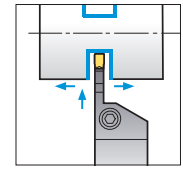
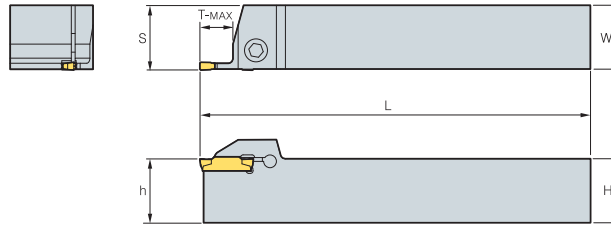
Application	Picture	Designation	Coated							Uncoated		Dimensions (mm)						Configuration	Page		
			NC3120	NC3225	NC3030	NC5330	NC6315	PC5300	PC8100	PC9030	H01	H05	b	r	l	d	t			α°	
Parting off	 MGMR-PS	MGMR 300-6D-PS										3.0	0.2	21	2.35	4.83	6		C30 C32		
		8D-PS										3.0	0.2	21	2.35	4.83	5				
		15D-PS										3.0	0.2	21	2.35	4.83	15				
		400-4D-PS										4.0	0.3	21	3.3	4.83	4				
		500-4D-PS										5.0	0.3	26	4.1	5.82	4				
	 MGML-PS	MGML 300-6D-PS										3.0	0.2	21.0	2.35	4.83	6				
		8D-PS										3.0	0.2	21.0	2.35	4.83	5				
		15D-PS										3.0	0.2	21.0	2.35	4.83	15				
		400-4D-PS										4.0	0.3	21	3.3	4.83	4				
		500-4D-PS										5.0	0.3	26	4.1	5.82	4				
Parting off	 MGMR-PT	MGMR 200-6D-PT										2.0	0.2	16	1.6	3.5	6		C30 C32		
		300-6D-PT										3.0	0.2	21	2.35	4.83	6				
		8D-PT	●									3.0	0.2	21	2.35	4.83	8				
		15D-PT										3.0	0.2	21	2.35	4.83	15				
		400-4D-PT										4.0	0.3	21	3.3	4.83	4				
	500-4D-PT										5.0	0.3	26	4.1	5.82	4					
	 MGML-PT	MGML 200-6D-PT										2.0	0.2	16	1.6	3.50	6				
		300-6D-PT										3.0	0.2	21	2.35	4.83	6				
		8D-PT			●							3.0	0.2	21	2.35	4.83	8				
		15D-PT										3.0	0.2	21	2.35	4.83	15				
400-4D-PT											4.0	0.3	21	3.30	4.83	4					
500-4D-PT										5.0	0.3	26	4.1	5.82	4						
Aluminum	 MRGN-A	MRGN 300-A										3.0	1.5	21.0	2.35	4.83	-		C30 C33 C34		
		400-A								●		4.0	2.0	21.0	3.3	4.83	-				
		500-A											5.0	2.5	26.0	4.1	5.82			-	
		600-A									●		6.0	3.0	26.0	5.0	5.81			-	
		800-A									●		8.0	4.0	31.0	6.0	6.52			-	
Relieving Profiling	 MRMN-M	MRMN 200-M	●	●	●					●		2.0	1.0	16.0	1.5	3.5	-		C30 ~34 C41		
		300-M	●	●	●	●					●	●	3.0	1.5	21.0	2.35	4.83			-	
		400-M	●	●	●	●						●		4.0	2.0	21.0	3.3			4.83	-
		500-M				●						●		5.0	2.5	26.0	4.1			5.82	-
		600-M		●	●	●								6.0	3.0	26.0	5.0			5.81	-
		800-M			●	●								8.0	4.0	31.0	6.0			6.52	-

● : Stock item



MGEHR/L

For grooving, turning, parting off, relief, profil machining



MGMN MGMR
MGGN MRMN
MRGN

• R type insert
(mm)

Designation	H = (h)	W	L	S	T-MAX	Inserts	Screw	Wrench
MGEHR/L 1616-1.5	16	16	100	16.2	14	MGMN150-G	LTX0514	TW20L
2020-1.5	20	20	125	20.2	14			
2525-1.5	25	25	150	25.2	14			
1212-2	12	12	100	14.25	14	MGMN200-G MGMN200-M MGMR200-□□-□□	MHA0512	HW40L
1616-2	16	16	100	16.25	14			
2020-2	20	20	125	20.25	14			
2525-2	25	25	150	25.25	14			
1616-2.5	16	16	100	16.30	16	MGMN250-G MGMN250-M	MHA0512	HW40L
2020-2.5	20	20	125	20.30	16			
2525-2.5	25	25	150	25.30	16			
1616-3	16	16	100	16.35	18	MGMN300-M/T MGGN300-□□-M MRMN300-M MGMR300-□□-□□ MGMN300-□□-L/R	BHA0616	HW50L
2020-3-T10	20	20	125	20.4	10			
2020-3	20	20	125	20.4	18			
2525-3-T10	25	25	150	25.4	10			
2525-3	25	25	150	25.4	18			
3232-3-T10	32	32	170	32.4	10			
3232-3	32	32	170	32.4	18			
2020-4-T10	20	20	125	20.4	10			
2020-4	20	20	125	20.4	18			
2525-4-T10	25	25	150	25.4	10			
2525-4	25	25	150	25.4	18			
3232-4-T10	32	32	170	32.4	10	MGMN400-M/T MGGN400-□□-M MRMN400-M MGMR400-□□-□□ MGMN400-□□-L/R	BHA0616	HW50L
3232-4	32	32	170	32.4	18			
2020-5-T15	20	20	150	20.5	15			
2020-5	20	20	150	20.5	23			
2525-5-T15	25	25	150	25.5	15	MGMN500-M/T MGGN500-□□-M MRMN500-M MGMR500-□□-□□ MGMN500-□□-L/R	BHA0616	HW50L
2525-5	25	25	150	25.5	23			
3232-5-T15	32	32	170	32.5	15			
3232-5	32	32	170	32.5	23			
2020-6-T15	20	20	125	20.6	15	MGMN600-M MGGN600-□□-M MRMN600-M	BHA0616	HW50L
2020-6	20	20	125	20.6	23			
2525-6-T15	25	25	150	25.6	15			
2525-6	25	25	150	25.6	23			
3232-6-T15	32	32	170	32.6	15	MRMN800-M MGMN800-M	BHA0616	HW50L
3232-6	32	32	170	32.6	23			
2525-8-T15	25	25	150	26.1	15			
2525-8	25	25	150	26.1	28			
3232-8-T15	32	32	170	33.1	16	MRGN600-A	BHA0616	HW50L
3232-8	32	32	170	33.1	28			
2525-6A-T15	25	25	150	25.6	15			
2525-6A	25	25	150	25.6	23			
3232-6A-T15	32	32	170	32.6	15	MRGN800-A	BHA0616	HW50L
3232-6A	32	32	170	32.6	23			
2525-8A-T15	25	25	150	26.1	16			
2525-8A	25	25	150	26.1	28			
3232-8A-T15	32	32	170	33.1	15	MRGN800-A	BHA0616	HW50L
3232-8A	32	32	170	33.1	28			

↻ Applicable inserts C28~C30

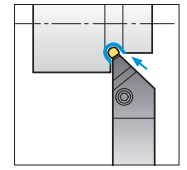
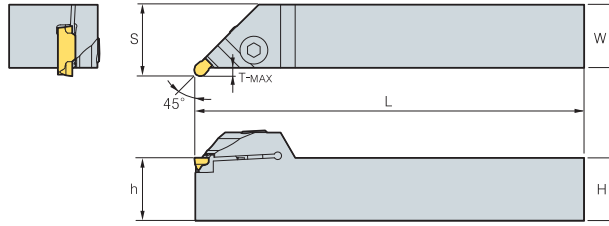


MGEUR/L

For relief, profil machining



MRMN
MRGN



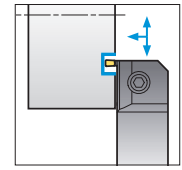
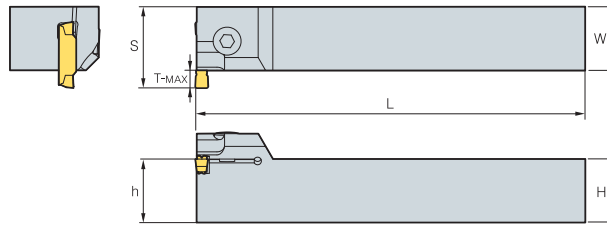
• R type insert
(mm)

Designation		H = (h)	W	L	S	T-MAX	Inserts	Screw	Wrench
MGEUR/L	2020-3	20	20	125	23	3	MRMN300-M	BHA0616	HW50L
	2525-3	25	25	150	28	3			
	3232-3	32	32	170	35	3			
	2020-4	20	20	125	23	3	MRMN400-M		
	2525-4	25	25	150	28	3			
	3232-4	32	32	170	35	3			
	2020-5	20	20	125	24	4	MRMN500-M		
	2525-5	25	25	150	29	4			
	3232-5	32	32	170	36	4			
	2020-6	20	20	125	24	4	MRMN600-M		
	2525-6	25	25	150	29	4			
	3232-6	32	32	170	36	4			
	2525-8	25	25	150	30	5	MRMN800-M		
	3232-8	32	32	170	37	5			
	2525-6A	25	25	150	29	4	MRGN600-A		
	3232-6A	32	32	170	36	4			
	2525-8A	25	25	150	30	5	MRGN800-A		
	3232-8A	32	32	170	37	5			

↻ Applicable inserts C28~C30

MGEVR/L

For grooving, turning, profil machining



MGMN MGGN
MRMN MRGN

• R type insert
(mm)

Designation		H = (h)	W	L	S	T-MAX	Min. machining Dia. (ØD)	Inserts	Screw	Wrench
MGEVR/L	2020-1.5	20	20	125	23	3	85	MGMN150-G	LTX0514	TW20L
	2525-1.5	25	25	150	28	3	85			
	3232-1.5	32	32	170	35	3	85			
	2020-2	20	20	125	23.5	3.5	65	MGMN200-M MGMN200-G	BHA0616	HW50L
	2525-2	25	25	150	28.5	3.5	65			
	3232-2	32	32	170	35.5	3.5	65			
	2020-2.5	20	20	125	24	4	65	MGMN250-M MGMN250-G		
	2525-2.5	25	25	150	29	4	65			
	3232-2.5	32	32	170	36	4	65			
	2020-3	20	20	125	25.5	5	75	MGMN300-M/T MGGN300-□-M MRMN300-M MGMN300-□□-L/R		
	2525-3	25	25	150	30.5	5	75			
	3232-3	32	32	170	37.5	5	75			
	2020-4	20	20	125	25.5	5	70			
	2525-4	25	25	150	30.5	5	70	MGMN400-M/T MGGN400-□□-M MRMN400-M MGMN400-□□-L/R		
	3232-4	32	32	170	37.5	5	70			
	2020-5	20	20	125	27	7	75			
	2525-5	25	25	150	32	7	75	MGMN500-M/T MGGN500-□□-M MRMN500-M MGMN500-□□-L/R		
	3232-5	32	32	170	39	7	75			
	2020-6	20	20	125	27	7	70			
	2525-6	25	25	150	32	7	70	MGMN600-M MGGN600-□□-M MRMN600-M		
	3232-6	32	32	170	39	7	70			
	2525-8	25	25	150	34	9	50			
	3232-8	32	32	170	41	9	50	MRMN800-M MGMN800-M		
	2525-6A	25	25	150	32	7	70	MRGN600-A MRGN800-A		
	3232-6A	32	32	170	39	7	70			
	2525-8A	25	25	150	34	9	45			
	3232-8A	32	32	170	41	9	45			

↻ Applicable inserts C28~C30

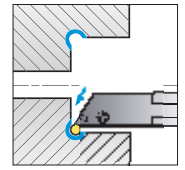
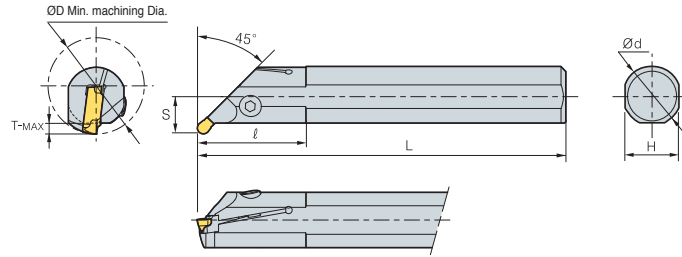


MGIUR/L

For relief, profil machining



MRMN
MRGN



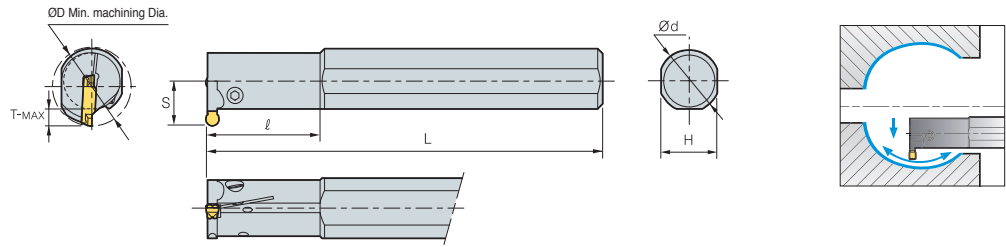
• R type insert
(mm)

Designation	ØD	Ød	L	l	T-MAX	H	S	Inserts	Screw	Wrench	
MGIUR/L 3520-3	35	20	150	45	3.5	18	13	MRMN300-M	MHA0512	HW40L	
	4025-3	40	25	200	45	3.5	23				15.5
	5032-3	50	32	250	65	3.5	30				19
3520-4	35	20	150	45	3.5	18	13	MRMN400-M	MHA0512	HW40L	
	4025-4	40	25	200	45	3.5	23				15.5
	5032-4	50	32	250	65	3.5	30				19
4025-5	40	25	200	45	3.5	23	15.5	MRMN500-M	BHA0616 BHA0620		
	5032-5	50	32	250	65	3.5	30				19
4025-6	40	25	200	45	3.5	23	19	MRMN600-M	BHA0616 BHA0620		
	5032-6	50	32	250	65	3.5	30				19
4025-8	40	25	200	45	6.5	23	15.5	MRMN800-M	BHA0616 BHA0620	HW50L	
	5032-8	50	32	250	65	6.5	30				19
4025-6A	40	25	200	45	3.5	23	15.5	MRGN600-A	BHA0616 BHA0620		
	5032-6A	50	32	250	65	3.5	30				19
4025-8A	40	25	200	45	5.0	23	18.5	MRGN800-A	BHA0616 BHA0620		
	5032-8A	50	32	250	65	6.5	30				22

➔ Applicable inserts C28~C30

MGIVR/L

For grooving, turning, profil machining



MGMN MRMN
MGGN MRGN

• R type insert
(mm)

Designation		ØD	Ød	L	ℓ	T-MAX	H	S	Inserts	Screw	Wrench			
MGIVR/L	2016-1.5	20	16	125	35	3.5	15	11.3	MGMN150-G	MHB0310	HW25L			
	2520-1.5	25	20	150	45	3.5	18	13.1		MHA0512	HW40L			
	2925-1.5	29	25	200	45	3.5	23	16.2						
	2016-2	20	16	125	35	4.5	15	12.4	MGMN200-G	MHB0310	HW25L			
	2520-2	25	20	150	45	4.5	18	14.0	MGMN200-M	MHA0512	HW40L			
	2925-2	29	25	200	45	4.5	23	17.2	MRMN200-M					
	2016-2.5	20	16	125	35	4.5	15	12.5	MGMN250-G	MHB0310	HW25L			
	2520-2.5	25	20	150	45	4.5	18	15.1	MGMN250-M	MHA0512	HW40L			
	2925-2.5	29	25	200	45	4.5	23	18.2						
	2520-3	25	20	150	45	5	18	15.6	MGMN300-M/G/T MGGN300-□□-M MRMN300-M MGMN300-□□-L/R	MHA0512	HW40L			
	2520-3-T7	25	20	150	49.3	7	18	19.92						
	3125-3	31	25	200	45	6	23	18.9						
	3125-3-T10	31	25	200	45	10	23	18.9						
	3732-3	37	32	250	65	6	30	21.5						
	3732-3-T12	37	32	250	65	12	30	21.5						
	2520-4	25	20	150	45	6	18	15.6				MGMN400-M/G/T MGGN400-□□-M MRMN400-M MGMN400-□□-L/R		
	2520-4-T7	25	20	150	45	7	18	15.6						
	3125-4	31	25	200	45	6	23	18.9						
	3125-4-T10	31	25	200	45	10	23	19						
	3732-4	37	32	250	65	6	30	21.5						
	3732-4-T12	37	32	250	65	12	30	21.5						
	3125-5	31	25	200	45	8	23	19.4						
	3732-5	37	32	250	65	8	30	21.5						
	3125-6	31	25	200	45	8	23	19.4				MGMN600-MG MGGN600-□□-M MRMN600-M	BHA0616	HW50L
	3732-6	37	32	250	65	8	30	21.5	MRMN800-M MGMN800-M	BHA0620				
	3732-8	37	32	250	65	10	30	23.4						
	4540-8	45	40	300	70	10	37	27.2	MRGN600-A	BHA0616				
	3125-6A	31	25	200	45	8	23	19.4						
	3732-6A	37	32	250	65	8	30	21.5						
	3732-8A	37	32	250	65	10	30	23.4	MRGN800-A	BHA0620				
4540-8A	45	40	300	70	10	37	27.2							

↻ Applicable inserts C28~C30

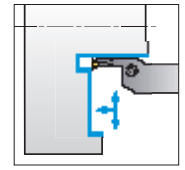
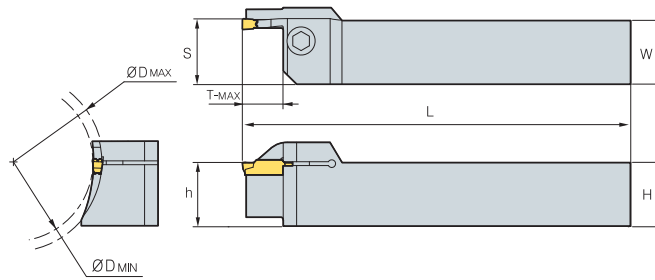


MGFHR/L

For face grooving machining



MFMN
MGMN



• R type insert
(mm)

Designation	H = (h)	W	L	S	T-MAX	ØD		Inserts	Screw	Wrench	
						Min	Max				
MGFHR/L	325-24/35-T10	25	25	150	25.6	10	24	35	MFMN300	BHA0616	HW50L
	29/40-T10	25	25	150	25.6	10	29	40			
	34/50-T10	25	25	150	25.6	10	34	50			
	44/70-T10	25	25	150	25.6	10	44	70			
	64/99-T10	25	25	150	25.6	10	64	99			
	425-42/63-T15	25	25	150	25.6	15	42	63			
	62/120-T15	25	25	150	25.6	15	62	120			
112/200-T15	25	25	150	25.6	15	112	200	MGMN400-M/T MGMN400-□□-L/R			

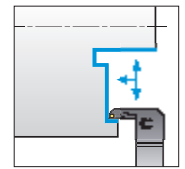
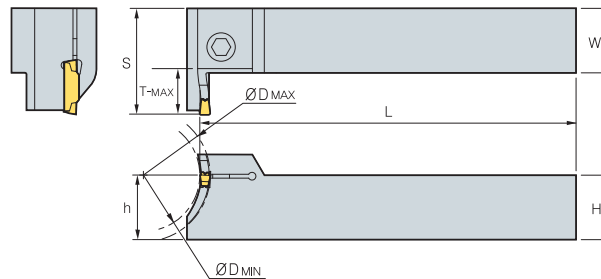
➔ Applicable inserts C28~C30

MGFVR/L

For face grooving machining



MFMN
MGMN



• R type insert
(mm)

Designation	H = (h)	W	L	S	T-MAX	ØD		Inserts	Screw	Wrench	
						Min	Max				
MGFVR/L	325-24/35-T10	25	25	150	36	10	24	35	MFMN300	MHA0512	HW40L
	29/40-T10	25	25	150	36	10	29	40			
	34/50-T10	25	25	150	36	10	34	50			
	44/70-T10	25	25	150	36	10	44	70			
	64/99-T10	25	25	150	36	10	64	99			
	425-44/60-T15	25	25	150	41	15	44	60			
	60/120-T15	25	25	150	41	15	60	120			
112/200-T15	25	25	150	41	15	112	200	MGMN400-M/T MGMN400-□□-L/R	BHA0616	HW50L	

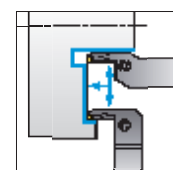
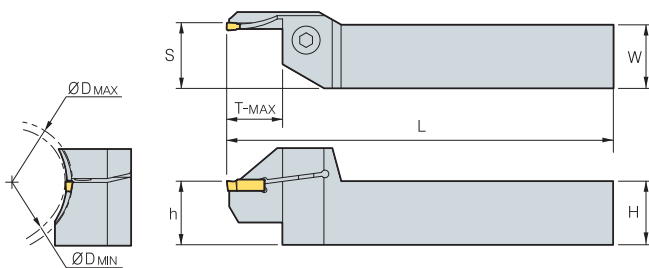
➔ Applicable inserts C28~C30

For face grooving, turning machining

FGHH



FGD FGM FMM



• R type insert
(mm)

Designation	H = (h)	W	L	S	T-MAX	ØD		Inserts	Screw	Wrench	
						Min	Max				
FGHH 320R - 25/30	20	20	125	20.6	12	25	30	FMM300R-03	BHA0616	HW50L	
	20	20	125	20.6	12	30	35				
	20	20	125	20.6	12	35	48				
	48/60	20	20	125	20.6	22	48	60			FGD300R-03 FGM300R-03
	60/75	20	20	125	20.6	22	60	75			
	75/100	20	20	125	20.6	22	75	100			
	100/140	20	20	125	20.6	22	100	140			
325R - 25/30	25	25	150	25.6	12	25	30	FMM300R-03			
	25	25	150	25.6	12	30	35				
	25	25	150	25.6	12	35	48				
	48/60	25	25	150	25.6	22	48	60			FGD300R-03 FGM300R-03
	60/75	25	25	150	25.6	22	60	75			
	75/100	25	25	150	25.6	22	75	100			
420R - 25/30	20	20	125	20.6	12	25	30	FMM400R-04			
	20	20	125	20.6	12	30	35				
	20	20	125	20.6	12	35	48				
	48/60	20	20	125	20.6	25	48	60	FGD400R-04 FGM400R-04		
	60/75	20	20	125	20.6	25	60	75			
	75/100	20	20	125	20.6	25	75	100			
425R - 25/30	25	25	150	25.6	12	25	30	FMM400R-04			
	25	25	150	25.6	12	30	35				
	25	25	150	25.6	12	35	48				
	48/60	25	25	150	25.6	25	48	60	FGD400R-04 FGM400R-04		
	60/75	25	25	150	25.6	25	60	75			
	75/100	25	25	150	25.6	25	75	100			
520R - 25/30	20	20	125	20.6	12	25	30	FMM500R-04			
	20	20	125	20.6	12	30	35				
	20	20	125	20.6	20	35	40				
	20	20	125	20.6	20	40	48				
	48/60	20	20	125	20.6	25	48	60	FGD500R-04 FGM500R-04		
	60/75	20	20	125	20.6	25	60	75			
	75/100	20	20	125	20.6	25	75	100			
525R - 25/30	25	25	150	25.6	12	25	30	FMM500R-04			
	25	25	150	25.6	12	30	35				
	25	25	150	25.6	20	35	40				
	25	25	150	25.6	20	40	48				
	48/60	25	25	150	25.6	25	48	60	FGD500R-04 FGM500R-04		
	60/75	25	25	150	25.6	25	60	75			
	75/100	25	25	150	25.6	25	75	100			
100/140	25	25	150	25.6	25	100	140				

➔ Applicable inserts C28~C30

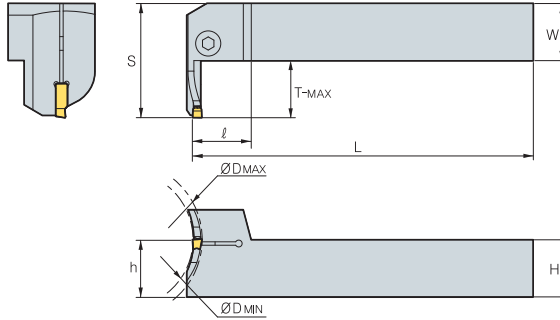


C MGT Series (Face Grooving)

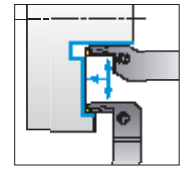
FGVH



FGD FGM FMM



For face grooving, turning machining



• R type insert
(mm)

Designation	H = (h)	W	L	S	T-MAX	ØD		Inserts	Screw	Wrench	
						Min	Max				
FGVH 320R - 25/30	20	20	125	20.6	12	25	30	FMM300R-03	BHA0616	HW50L	
	30/35	20	20	125	20.6	12	30				35
	35/48	20	20	125	20.6	12	35				48
	48/60	20	20	125	20.6	22	48	60			FGD300R-03 FGM300R-03
	60/75	20	20	125	20.6	22	60	75			
	75/100	20	20	125	20.6	22	75	100			
	100/140	20	20	125	20.6	22	100	140			
325R - 25/30	25	25	150	25.6	12	25	30	FMM300R-03			
	30/35	25	25	150	25.6	12	30				35
	35/48	25	25	150	25.6	12	35				48
	48/60	25	25	150	25.6	22	48	60			FGD300R-03 FGM300R-03
	60/75	25	25	150	25.6	22	60	75			
	75/100	25	25	150	25.6	22	75	100			
	100/140	25	25	150	25.6	22	100	140			
420R - 25/30	20	20	125	20.6	12	25	30	FMM400R-04			
	30/35	20	20	125	20.6	12	30		35		
	35/48	20	20	125	20.6	12	35		48		
	48/60	20	20	125	20.6	25	48	60	FGD400R-04 FGM400R-04		
	60/75	20	20	125	20.6	25	60	75			
	75/100	20	20	125	20.6	25	75	100			
	100/140	20	20	125	20.6	25	100	140			
425R - 25/30	25	25	150	25.6	12	25	30	FMM400R-04			
	30/35	25	25	150	25.6	12	30		35		
	35/48	25	25	150	25.6	12	35		48		
	48/60	25	25	150	25.6	25	48	60	FGD400R-04 FGM400R-04		
	60/75	25	25	150	25.6	25	60	75			
	75/100	25	25	150	25.6	25	75	100			
	100/140	25	25	150	25.6	25	100	140			
520R - 25/30	20	20	125	20.6	12	25	30	FMM500R-04			
	30/35	20	20	125	20.6	12	30		35		
	35/40	20	20	125	20.6	20	35		40		
	40/48	20	20	125	20.6	20	40		48		
	48/60	20	20	125	20.6	25	48	60	FGD500R-04 FGM500R-04		
	60/75	20	20	125	20.6	25	60	75			
	75/100	20	20	125	20.6	25	75	100			
100/140	20	20	125	20.6	25	100	140				
525R - 25/30	25	25	150	25.6	12	25	30	FMM500R-04			
	30/35	25	25	150	25.6	12	30		35		
	35/40	25	25	150	25.6	20	35		40		
	40/48	25	25	150	25.6	20	40		48		
	48/60	25	25	150	25.6	25	48	60	FGD500R-04 FGM500R-04		
	60/75	25	25	150	25.6	25	60	75			
	75/100	25	25	150	25.6	25	75	100			
100/140	25	25	150	25.6	25	100	140				

➔ Applicable inserts C28~C30



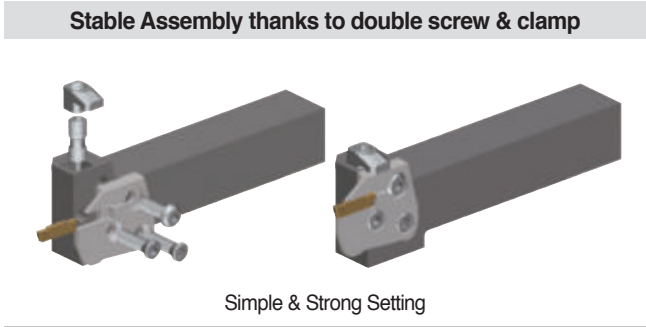
C

Multi functional Tools

KGT/MGT cartridge

➤ Features

- Compatible and Economical due to divided cartridge & exclusive holder system from existing single body system
- Interchangeable cartridge
 - Various assembly depends on working style
 - Reduce cutting tool costs by over 30%
 - Setting with upper clamp & side screw
- Strong & Stable setting force
 - Simultaneous assembly of insert & cartridge
 - Easy assembly & tool exchange
- Stable assembly system
 - Simple & Superior setting force

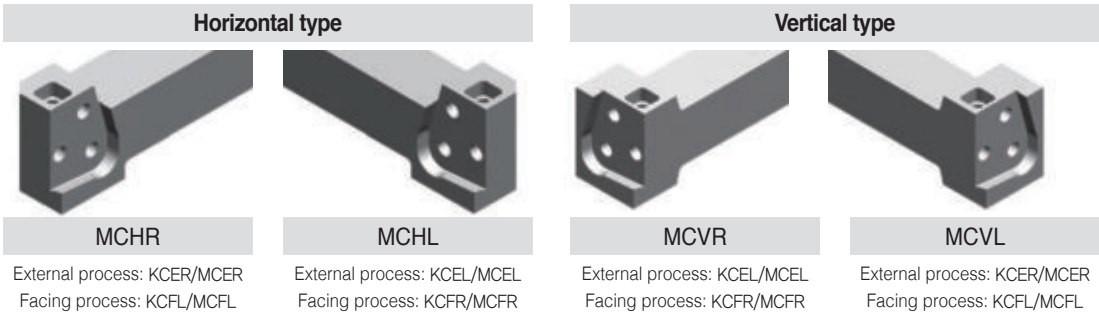


➤ Code system

• Holder



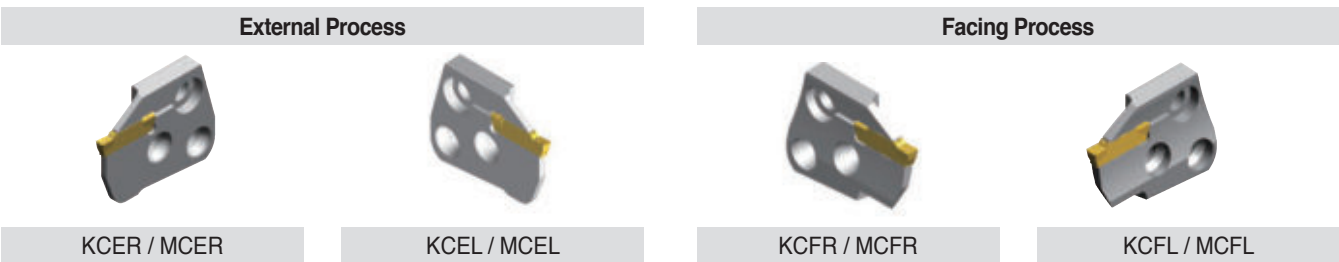
System Code	Holder Style	Hand	Height (mm)	Width (mm)
KC: KGT-Cartridge System MC: MGT-Cartridge System	H: Horizontal V: Vertical			



• Cartridge



System Code	Working Style	Hand	Cutting Width (mm)	Facing Dia (min/max)	Maximum Depth (mm)
KC: KGT-Cartridge System MC: MGT-Cartridge System	E: External Process F: Facing Process				

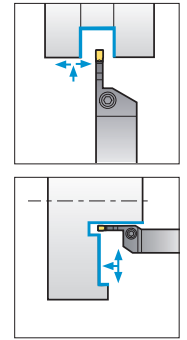
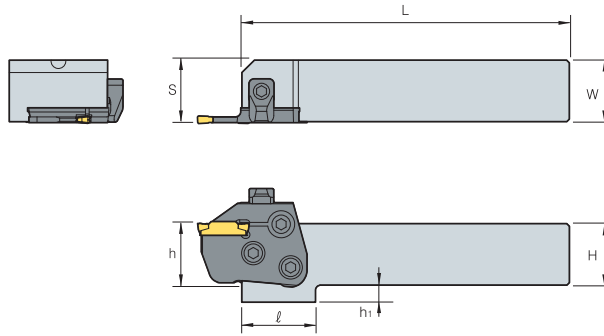


MCHR/L (Holder)

For grooving, turning, parting off, relief, profil machining



MCER/L
MCFR/L



• R type insert

(mm)

Designation	H = (h)	W	L	S	ℓ	h ₁	Cartridge	Clamp	Clamp Screw	Hinge Screw	Clamping Screw	Wrench	
MCHR/L	2020	20	20	133	20.7	30	12	KCER/L, KCFR/L MCER/L, MCFR/L	CXH8N	DHA0818F	RHA0613	FHGA0618	HW40L
	2525	25	25	133	25.7	30	7						
	3232	32	32	153	32.7	-	-						

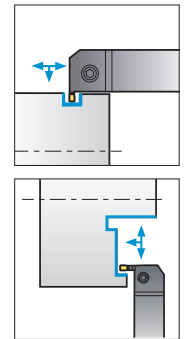
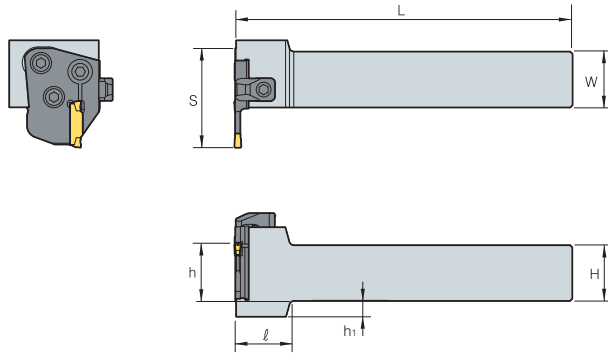
➔ Applicable cartridge C41~C42

MCVR/L (Holder)

For face grooving, turning machining



MCER/L
MCFR/L



• R type insert

(mm)

Designation	H = (h)	W	L	S	ℓ	h ₁	Cartridge	Clamp	Clamp Screw	Hinge Screw	Clamping Screw	Wrench	
MCVR/L	2020	20	20	150	38	30	12	KCER/L, KCFR/L MCER/L, MCFR/L	CXH8N	DHA0818F	RHA0613	FHGA0618	HW40L
	2525	25	25	150	43	30	7						
	3232	32	32	170	50	-	-						

➔ Applicable cartridge C41~C42

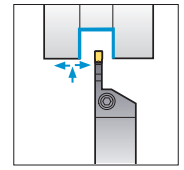
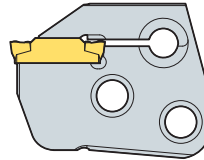
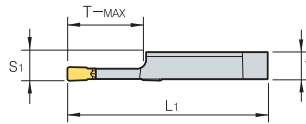
KCER/L (Cartridge)

For grooving, turning, parting off, relief, profil machining



KGMM
KGGN

KGMR/L
KRMN



• R type insert
(mm)

Designation	T	L ₁	S ₁	T-MAX	Inserts		Holder	
					Width	Designation		
KCER/L	3-T16	5.97	44.5	6.35	16	3	KGMM KGMR/L KGGN KRMN	MCVR/L MCHR/L
	4-T16	5.97	44.5	6.35	16	4		
	5-T20	5.87	48.5	6.35	20	5		
	6-T20	5.82	48.5	6.35	20	6		

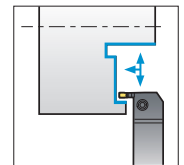
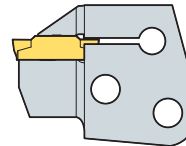
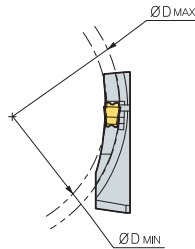
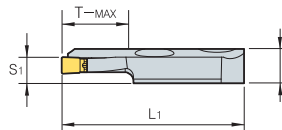
↻ Applicable inserts C12~C14

KCFR/L (Cartridge)

For face grooving, turning machining



KGMM
KGMI



• R type insert
(mm)

Designation	T	L ₁	S ₁	T-MAX	ØD		Inserts		Holder	
					Min	Max	Width	Designation		
KCFR/L	3-34/50-T16	8.35	44.5	6.35	16	34	50	3	KGMM KRMN KGGN	MCVR/L MCHR/L
	44/70-T16	8.35	44.5	6.35	16	44	70	3		
	64/99-T16	8.35	44.5	6.35	16	64	99	3		
	4-44/60-T16	8.35	44.5	6.35	16	44	60	4		
	60/120-T16	8.35	44.5	6.35	16	60	120	4		
	112/200-T16	8.35	44.5	6.35	16	112	200	4		

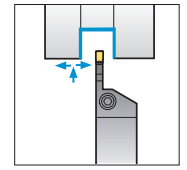
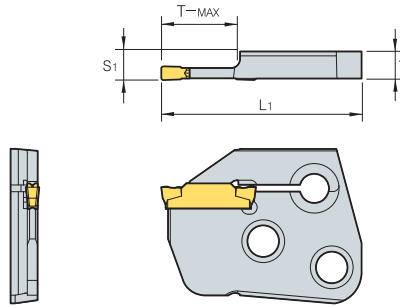
↻ Applicable inserts C12~C14

MCER/L (Cartridge)

For grooving, turning, parting off, relief, profil machining



MGMN MGMR
MGGN MRMN



• R type insert
(mm)

Designation	T	L ₁	S ₁	T-MAX	Inserts		Holder	
					Width	Designation		
MCER/L	3-T16	6.00	44.5	6.35	16	3	MGMN	MCVR/L MCHR/L
	4-T16	5.97	44.5	6.35	16	4	MGMR/L	
	5-T20	5.87	48.5	6.35	20	5	MGGN	
	6-T20	5.82	48.5	6.35	20	6	MRMN	

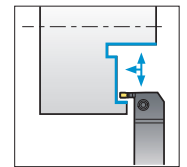
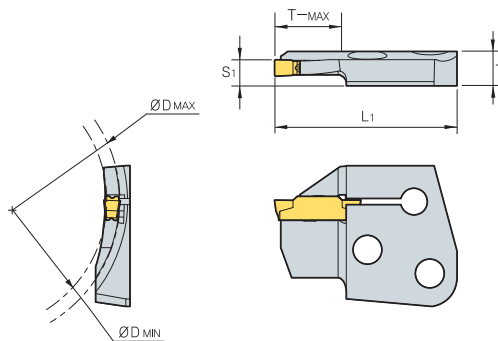
↻ Applicable inserts C28~C30

MCFR/L (Cartridge)

For face grooving, turning machining



MFNM
MGMN



• R type insert
(mm)

Designation	T	L ₁	S ₁	T-MAX	ØD		Inserts		Holder	
					Min	Max	Width	Designation		
MCFR/L	3-24/35-T16	8.00	44.5	6.35	16	24	35	3	MFNM300	MCVR/L MCHR/L
	29/40-T16	8.00	44.5	6.35	16	29	40	3		
	34/50-T16	8.00	44.5	6.35	16	34	50	3		
	44/70-T16	8.00	44.5	6.35	16	44	70	3		
	64/99-T16	8.00	44.5	6.35	16	64	99	3		
4-44/60-T16	60/120-T16	7.97	44.5	6.35	16	44	60	4	MGMN400	
	112/200-T16	7.97	44.5	6.35	16	112	200	4		

↻ Applicable inserts C28~C30

MGT - Machining aluminum wheels

Features

- Optimally designed inserts for aluminum wheel machining
- Longer tool life when matched with the best grade for application
- Unique clamping mechanism places a strong clamp over the insert
- A variety of insert types for multi application functions

Code system

Insert

MR	G	N	6	-	A
System Code	Tolerance	Hand	Cutting Edge Width		Chip Breaker
MR: Multi Grooving Round shape MV: Multi Grooving V shape	G: Ground	N: Neutral	6 mm, 8 mm		A/AM/AP/A5

Holder

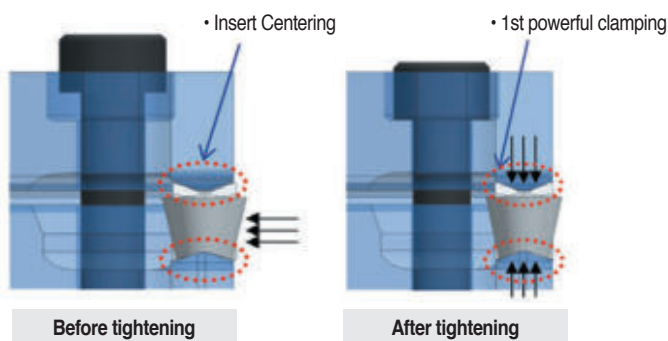
MG	E	H	R/L	25N	-	8	A	-	MR
System Code	Application	Holder Type	Hand	Shank Size	Cutting Width	Chip Breaker		Chip Breaker	Insert Type
MG: Multi Grooving	E: External machining I: Internal machining	H: Horizontal V: Vertical U: Undercut X: Special	R: Right L: Left	Height: 25 mm Width: 25 mm (For internal machining: Minimum diameter)	1.5~8.0 mm	A/AM/ AP/A5		A/AM/ AP/A5	MR: ROUND shape MV: V shape

Various insert types

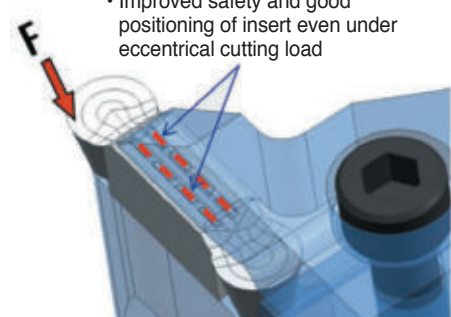
MRGN type : Full "Round" geometry

MRGN-A (For general)	MRGN-A5 (For copying)	MRGN-AM (Medium finishing)	MRGN-AP (PCD)	MVGN-A (For fine finishing)
				
High rake angle, Sharp cutting edge	Reinforced clamping force	For ductile cast iron	Improved chip control	High rake and relief angle

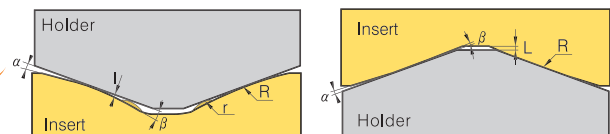
New clamping system



- Improved safety and good positioning of insert even under eccentric cutting load

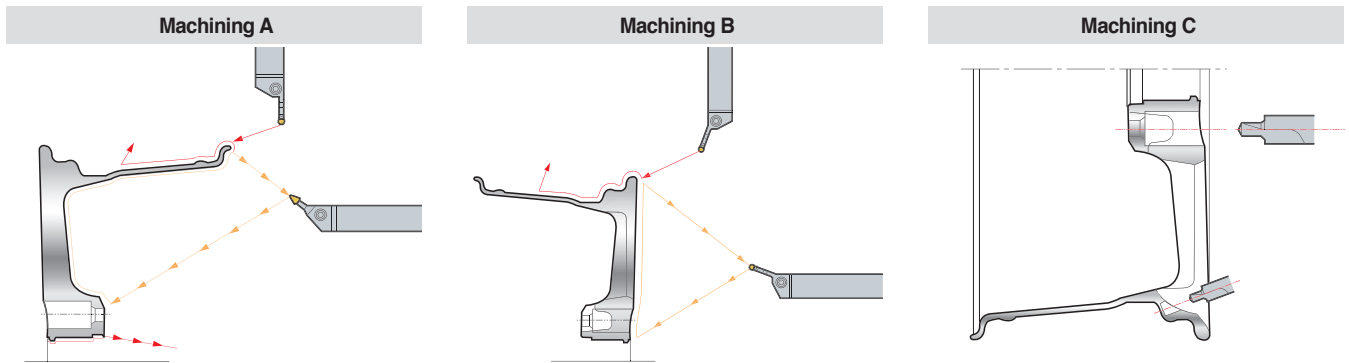


- Reinforcing the clamping force due to radius designed on the top & bottom side of insert and convex "DOT" on the top of insert



C Available Insert for MGT Aluminum Wheel


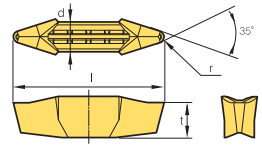

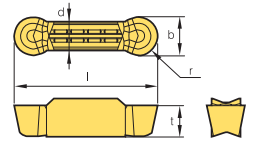
Application of aluminum wheels



Recommended cutting condition

Workpiece		Hardness Brinell (HB)	kc (MPa)	vc (m/min)	fn (mm/rev)
Aluminum alloy (Forged)	Unhardened	50~70	500~600	1,000~2,500	0.1~0.6
	Hardened	90~110	700~900	300~1,000	0.1~0.5
Aluminum alloy (Cast)	Unhardened	70~80	700~800	300~1,000	0.1~0.5
	Hardened	80~110	800~950	200~600	0.1~0.4
Copper alloy		90~110	700~900	300~800	0.1~0.5
Magnesium alloy		70~80	700~800	300~1,000	0.1~0.5

Insert

Application	Picture	Designation	Coated	Uncoated	Dimensions (mm)					Configuration	Page		
			DP150	G10	b	r	l	d	t				
For Aluminum Wheel		MVGN	8N-A-R1.2			-	1.2	30.0	6.0	6.9		C46	
			8N-A-R1.6			-	1.6	30.0	6.0	6.9			
		MRGN-A	MRGN	6N-A		●	6.0	3.0	26.0	5.0	5.9		C45 C46
				6N-AM			6.0	3.0	26.0	5.0	5.9		
				6N-AP			6.0	3.0	26.0	5.0	5.9		
				6N-A5		●	6.0	3.0	26.0	5.0	5.9		
				8N-A			8.0	4.0	30.0	6.0	6.5		
				8N-AM			8.0	4.0	30.0	6.0	6.5		
				8N-AP			8.0	4.0	30.0	6.0	6.5		
				8N-A5		●	8.0	4.0	30.0	6.0	6.5		

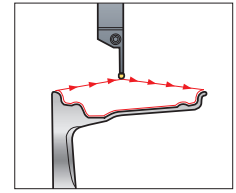
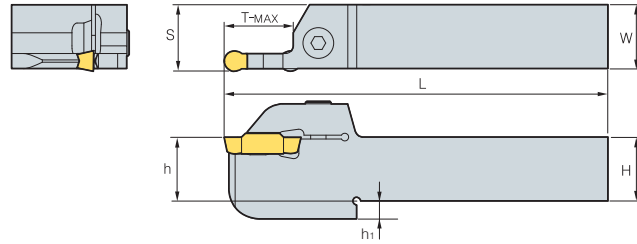
● : Stock item



MGEHR/L



MRGN



• R type insert
(mm)

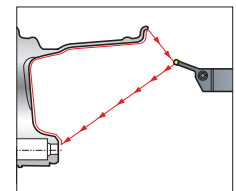
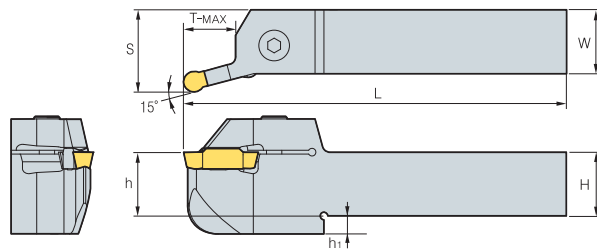
Designation	H = (h)	h ₁	W	L	S	T-MAX	Inserts	Screw	Wrench	
MGEHR/L	25N-6A	25	7	25	150	25.55	23.5	MRGN6N-A/AP/AM	BHA0620	HW50L
	32N-6A	32	8	32	150	32.55	27			
	25N-8A	25	7	25	150	25.55	23.5	MRGN8N-A/AP/AM		
	32N-8A	32	8	32	150	32.55	27			
	25N-6A5	25	7	25	150	25.55	23.5	MRGN6N-A5		
	32N-6A5	32	8	32	150	32.55	27	MRGN8N-A5		
	25N-8A5	25	7	25	150	25.55	23.5			
	32N-8A5	32	8	32	150	32.55	27			

↻ Applicable inserts C44

MGEHR/L-15



MRGN



• R type insert
(mm)

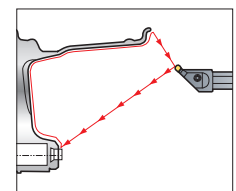
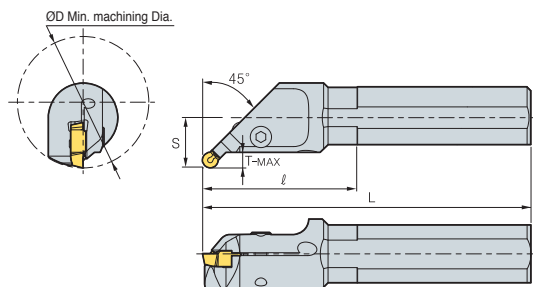
Designation	H = (h)	h ₁	W	L	S	T-MAX	Inserts	Screw	Wrench	
MGEHR/L	25N-6A-15	25	7	25	150	32.2	20	MRGN6N-A/AP/AM	BHA0620	HW50L
	32N-6A-15	32	8	32	150	39.2	25			
	25N-8A-15	25	7	25	150	32.2	20	MRGN8N-A/AP/AM		
	32N-8A-15	32	8	32	150	39.2	25			
	25N-6A5-15	25	7	25	150	32.2	20	MRGN6N-A5		
	32N-6A5-15	32	8	32	150	39.2	25	MRGN8N-A5		
	25N-8A5-15	25	7	25	150	32.2	20			
	32N-8A5-15	32	8	32	150	39.2	25			

↻ Applicable inserts C44

MGIUR/L-MR



MRGN



• R type insert
(mm)

Designation	ØD	Ød	L	ℓ	T-MAX	H	S	Inserts	Screw	Wrench	
MGIUR/L	6832-8A-MR	68	32	170	65	7	30	26	MRGN8N-A/AM/AP	BHA0620	HW50L
	6832-8A5-MR	68	32	170	65	7	30	26	MRGN8N-A5		

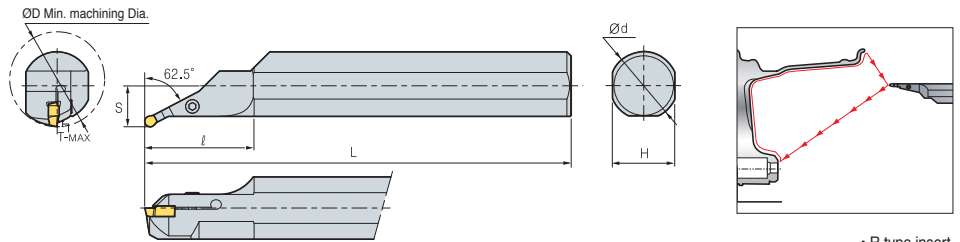
↻ Applicable inserts C44



MGIXR/L-MR



MRGN



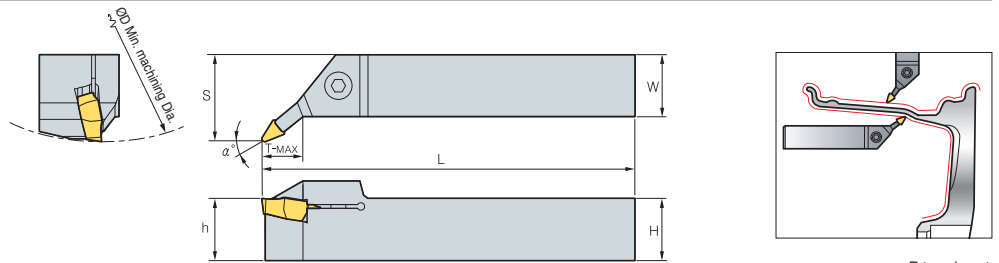
Designation	ØD	Ød	L	l	T-MAX	H	S	Inserts	Screw	Wrench
MGIXR/L 7050-8A-MR	70	50	350	80	5.5	46	30.2	MRGN8N-A/AM/AP	BHA0620	HW50L
7050-8A5-MR	70	50	350	80	5.5	46	30.2	MRGN8N-A5		

➔ Applicable inserts C44

MGEXR/L



MVGN



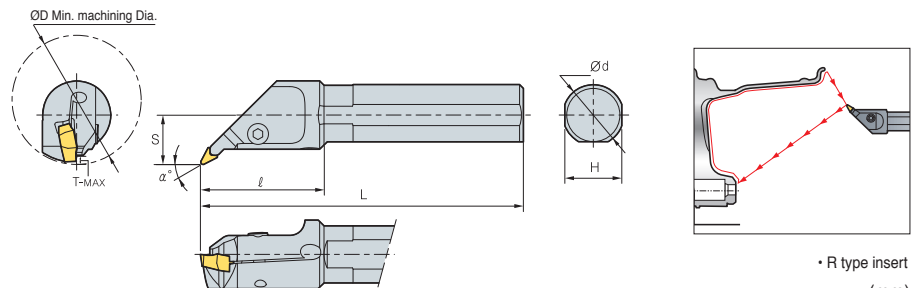
Designation	H = (h)	W	L	S	T-MAX	α°	Inserts	Screw	Wrench
MGEXR/L 25N-8A-5V	25	25	150	29	23.5	5	MVGN8N-A-R1.2	BHA0620	HW50L
25N-8A-22.5V	25	25	150	35	27	22.5	MVGN8N-A-R1.6		

➔ Applicable inserts C44

MGIUR/L-MV



MVGN



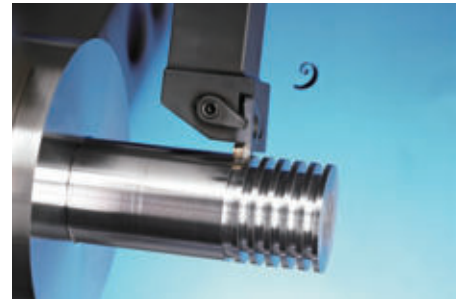
Designation	ØD	Ød	L	l	T-MAX	H	S	α°	Inserts	Screw	Wrench
MGIUR/L 6832-8A-MV	68	32	170	65	4.5	30	26	27.5	MVGN8N-A-R1.2 MVGN8N-A-R1.6	BHA0620	HW50L

➔ Applicable inserts C44

Economical 3-corner insert for high precision grooving

TB/TB-M

- Economical 3-corner insert for grooving
- Various cutting edge size ranging from 1.25~4.5 mm
- High accuracy ground insert ensures high precision machining
- Stable chip control optimized for automated grooving process



Code system

• Insert

TB	5	150	N	-	010	M
Triangle Blade	Inscribed circle	Cutting edge width	Hand		Nose R	Chip breaker
	3: 9.525 mm 4: 12.7 mm 5: 15.875 mm	0.5~4.5 mm	N: Neutral R: Right L: Left		0.00~0.40 mm	None M

• Holder

TBH	5	25	R
Triangle Blade Holder	Inscribed circle	Shank size	Hand
	3: 9.525 mm 4: 12.7 mm 5: 15.875 mm	10~25 mm	R: Right L: Left

TB/TB-M

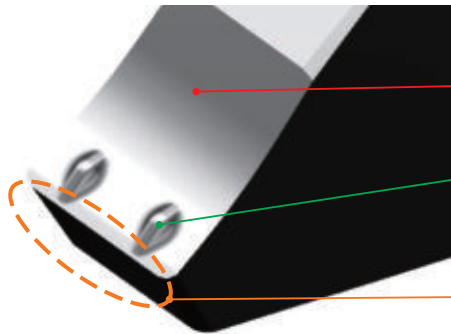
Specification	TB3000R/L, TB4000R/L	TB4000R-M	TB5000N-000-M	
Designation	TB3125R/L~TB3430R/L (Inscribed circle of 9.525 mm) TB4125R/L~TB4430R/L (Inscribed circle of 12.7 mm)	TB4150R-M~TB4450R-M (Inscribed circle of 12.7 mm)	TB5050N-000-M~TB5318-020-M (Inscribed circle of 15.875 mm)	
Insert shape				
Features	Chip breaker	Ground chip breaker	Pressed chip breaker	
	Hand	Right/Left-handed	Right-handed	Neutral
	Cutting edge width (b)	TB3000: 1.25~4.3 mm TB4000: 1.25~4.5 mm	1.5~4.5 mm	0.5~3.18 mm
	Depth of cut (T-MAX)	TB3000: ~3.5 mm TB4000: ~5.0 mm	~5.0 mm	~6.5 mm
	Shape	○	X	X
	Cutting edge width	○	○	○
Chip breaker shape				
Application range	P	P, M, K	P, M, K	
Grade	CN2500, PC5300	CN2500, PC5300	PC5300	



C Technical Information for TB/TB-M

TB-M chip breaker

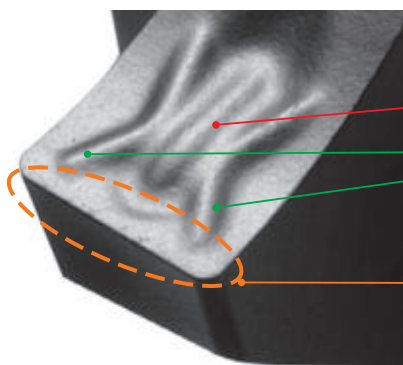
- Minimized cutting force at high speed and high feed → Smooth chip evacuation outside each groove
- High precision cutting performance → Exceptional surface finish and accurate dimensions
- Excellent chip flow and cutting results → Ideal for automated and unmanned productionw



TB5-M Chip breaker

- **Lowered back area:** reduced load of chip evacuation due to minimizing chip friction
- **Beveled protruding dot:** made regular sized chip curls good chip flow out of the groove by reducing the chip width minimized load for chip evacuation in high depth of cut
- **Land:** prevented chipping and increased stability in interrupted machining
- **Use:** for grooving with T-MAX 6.5 mm below, parting and interrupted machining

Designation	TB5050N-M ~TB5120N-M	TB5140N-M ~TB5178N-M	TB5196N-M ~TB5239N-M	TB5247N-M ~TB5287N-M	TB5300N-M ~TB5318N-M
Shape					
Cutting edge width (b)	0.5~1.2 mm	1.40~1.78 mm	1.96~2.39 mm	2.47~2.87 mm	3.0~3.18 mm



TB4-M Chip breaker

- **Second protruding dot:** stable chip curl control
- **Main protruding dot:** making regular sized chip curl good chip flow out of the groove by reducing the chip width good chip control in turning and chamfering
- **Sharp cutting edge:** increased machinability
- **Use:** for grooving with T-MAX 4.5 mm below and turning

Designation	TB4150R-M~TB4185R-M	TB4200R-M~TB4228R-M	TB4300R-M~TB4350R-M	TB4400R-M~TB4450R-M
Shape				
Cutting edge width (b)	1.5~1.85 mm	2.0~2.8 mm	3.0~3.5 mm	4.0~4.5 mm



Guide for TB

(mm)

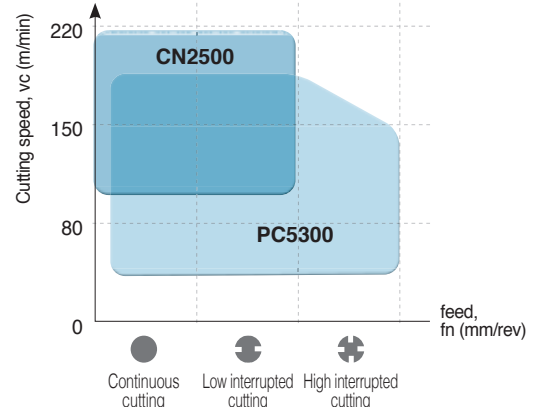
TB				TB3 / TB4	TB4-M	TB5-M	
Recommended machining method							
Cutting edge width W	Depth of cut T-MAX			Recommended feed rate (mm/rev)			
	TB3/TB4	TB4-M	TB5-M				
0.50	-	-	2.5	-	-	●	
0.80	-	-	1.6	-	-	●	
1.00	-	-	3.5	-	-	●	
1.04	-	-	2.0	-	-	●	
1.20	-	-	2.0	-	-	●	
1.25	2.0	-	2.0	●	-	-	
1.40	2.0	-	6.5	●	-	●	
1.45	2.0	-	-	●	-	-	
1.47	-	-	6.5	-	-	●	
1.50	3.5	3.5	6.5	●	●	●	
1.57	-	-	6.5	-	-	●	
1.70	-	-	6.5	-	-	●	
1.75	3.5	3.5	-	●	●	-	
1.78	-	-	6.5	-	-	●	
1.85	3.5	3.5	-	●	●	-	
1.96	-	-	6.5	-	-	●	
2.00	3.5	3.5	6.5	●	●	●	
2.15	3.5	3.5	-	●	●	-	
2.22	6.5	-	6.5	-	-	●	
2.30	3.5	3.5	6.5	●	●	●	
2.39	-	-	6.5	-	-	●	
2.47	-	-	6.5	-	-	●	
2.50	4.0	4.0	6.5	●	●	●	
2.65	4.0	4.0	6.5	●	●	-	
2.70	-	-	6.5	-	-	●	
2.80	4.0	4.0	-	●	●	-	
2.87	-	-	6.5	-	-	●	
3.00	4.0	4.0	6.5	●	●	●	
3.15	-	-	6.5	-	-	●	
3.18	-	-	6.5	-	-	●	
3.30	4.0	-	-	●	-	-	
3.50	5.0	5.0	-	●	●	-	
4.00	5.0	5.0	-	●	●	-	
4.30	5.0	5.0	-	●	●	-	
4.50	5.0	5.0	-	●	●	-	

Recommended cutting conditions

Workpiece	Grade	CN2500 (Cermet)			PC5300 (Coated)		
		Min	Recommended	Max.	Min	Recommended	Max.
P	SM□□C type	100	160	220	80	140	200
	SCM type	100	150	200	80	130	180
M	STS type	-	-	-	40	80	150
K	GC, GCD type	-	-	-	80	130	180

Recommended cutting speed, vc (m/min)

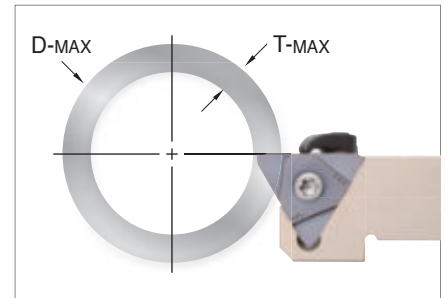
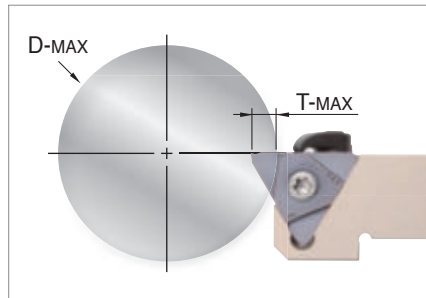
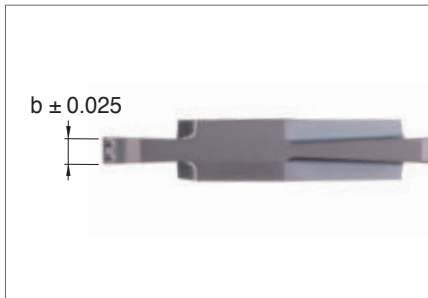
Recommended cutting range



C Technical Information for TB/TB-M

🔗 TB5-M machining range

- There is a limit to cutting diameters of TB5-M when depth of cuts are over 5 mm
(e.g. When cutting with a TB5200N-020-M insert at the depth of 6.2 mm, Ø60 D-MAX is available)
- N.L = No limit


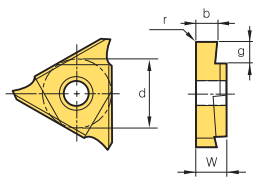

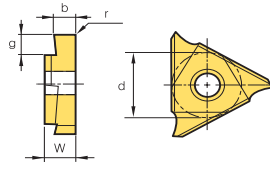


(mm)

Designation	b	r	g (T-MAX)	ØD-MAX									
				T ≤ 3.0	T ≤ 3.5	T ≤ 4.0	T ≤ 4.5	T ≤ 5.0	T ≤ 5.5	T ≤ 6.0	T ≤ 6.4	T ≤ 6.5	
TB 5050N- 000-M	0.50	0.00	1.0	-	-	-	-	-	-	-	-	-	-
004-M	0.50	0.04	2.5	-	-	-	-	-	-	-	-	-	-
5080N- 000-M	0.80	0.00	1.6	-	-	-	-	-	-	-	-	-	-
5100N- 006-M	1.00	0.06	3.5	-	-	-	-	-	-	-	-	-	-
5104N- 000-M	1.04	0.00	2.0	-	-	-	-	-	-	-	-	-	-
5120N- 000-M	1.20	0.00	2.0	-	-	-	-	-	-	-	-	-	-
5140N- 000-M	1.40	0.00	6.5	N.L	N.L	N.L	N.L	N.L	Ø300	Ø170	Ø60	Ø40	
5147N- 000-M	1.47	0.00	6.5	N.L	N.L	N.L	N.L	N.L	Ø300	Ø170	Ø60	Ø40	
5150N- 010-M	1.50	0.10	6.5	N.L	N.L	N.L	N.L	N.L	Ø300	Ø170	Ø60	Ø40	
015-M	1.50	0.15	6.5	N.L	N.L	N.L	N.L	N.L	Ø300	Ø170	Ø60	Ø40	
5157N- 015-M	1.57	0.15	6.5	N.L	N.L	N.L	N.L	N.L	Ø300	Ø170	Ø60	Ø40	
5170N- 010-M	1.70	0.10	6.5	N.L	N.L	N.L	N.L	N.L	Ø300	Ø170	Ø60	Ø40	
5178N- 018-M	1.78	0.18	6.5	N.L	N.L	N.L	N.L	N.L	Ø300	Ø170	Ø60	Ø40	
5196N- 015-M	1.96	0.15	6.5	N.L	N.L	N.L	N.L	N.L	Ø300	Ø170	Ø60	Ø40	
5200N- 020-M	2.00	0.20	6.5	N.L	N.L	N.L	N.L	N.L	Ø300	Ø170	Ø60	Ø40	
5222N- 015-M	2.22	0.15	6.5	N.L	N.L	N.L	N.L	N.L	Ø300	Ø170	Ø60	Ø40	
5230N- 020-M	2.30	0.20	6.5	N.L	N.L	N.L	N.L	N.L	Ø300	Ø170	Ø60	Ø40	
5239N- 015-M	2.39	0.15	6.5	N.L	N.L	N.L	N.L	N.L	Ø300	Ø170	Ø60	Ø40	
5247N- 020-M	2.47	0.20	6.5	N.L	N.L	N.L	N.L	N.L	Ø300	Ø170	Ø60	Ø40	
5250N- 020-M	2.50	0.20	6.5	N.L	N.L	N.L	N.L	N.L	Ø300	Ø170	Ø60	Ø40	
5270N- 010-M	2.70	0.10	6.5	N.L	N.L	N.L	N.L	N.L	Ø300	Ø170	Ø60	Ø40	
5287N- 020-M	2.87	0.20	6.5	N.L	N.L	N.L	N.L	N.L	Ø300	Ø170	Ø60	Ø40	
5300N- 000-M	3.00	0.00	6.5	N.L	N.L	N.L	N.L	N.L	Ø300	Ø170	Ø60	Ø40	
5300N- 020-M	3.00	0.20	6.5	N.L	N.L	N.L	N.L	N.L	Ø300	Ø170	Ø60	Ø40	
040-M	3.00	0.40	6.5	N.L	N.L	N.L	N.L	N.L	Ø300	Ø170	Ø60	Ø40	
5315N- 015-M	3.15	0.15	6.5	N.L	N.L	N.L	N.L	N.L	Ø300	Ø170	Ø60	Ø40	
5318N- 020-M	3.18	0.20	6.5	N.L	N.L	N.L	N.L	N.L	Ø300	Ø170	Ø60	Ø40	




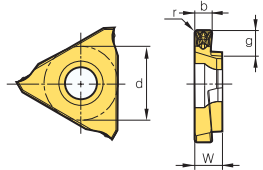

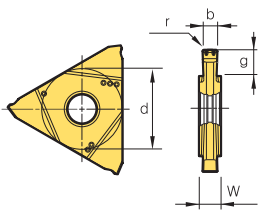
Insert

Picture	Designation	Cermet		Coated	Dimensions (mm)					Configuration	
		CN2000	CN2500	PC5300	b	g (T-MAX)	r	w	d		
	TB 3125R				1.25	1.5	0.2	4.76	9.525		
	3145R				1.45	1.5	0.2	4.76	9.525		
	3175R				1.75	2.5	0.2	4.76	9.525		
	3185R				1.85	2.5	0.2	4.76	9.525		
	3200R				2.00	2.5	0.2	4.76	9.525		
	3230R				2.30	3.5	0.3	4.76	9.525		
	3280R				2.80	3.5	0.3	4.76	9.525		
	3330R				3.30	3.5	0.3	4.76	9.525		
	3430R				4.30	3.5	0.4	4.76	9.525		
	4125R		●		●	1.25	2.0	0.2	4.76		12.7
	4145R		●		●	1.45	2.0	0.2	4.76		12.7
	4150R		●		●	1.50	3.5	0.2	4.76		12.7
	4175R		●		●	1.75	3.5	0.2	4.76		12.7
	4185R		●		●	1.85	3.5	0.2	4.76		12.7
	4200R		●		●	2.00	3.5	0.2	4.76		12.7
	4215R		●		●	2.15	3.5	0.2	4.76		12.7
	4230R		●		●	2.30	3.5	0.2	4.76		12.7
	4250R		●		●	2.50	4.0	0.3	4.76		12.7
	4265R		●		●	2.65	4.0	0.3	4.76		12.7
	4280R		●		●	2.80	4.0	0.3	4.76		12.7
	4300R		●		●	3.00	4.0	0.3	4.76		12.7
	4330R		●			3.30	4.0	0.3	4.76		12.7
	4350R		●			3.50	5.0	0.3	4.76		12.7
	4400R		●		●	4.00	5.0	0.4	4.76		12.7
	4430R		●		●	4.30	5.0	0.4	4.76		12.7
	4450R		●		●	4.50	5.0	0.4	4.76		12.7
	TB 3125L				1.25	1.5	0.2	4.76	9.525		
	3145L				1.45	1.5	0.2	4.76	9.525		
	3175L				1.75	2.5	0.2	4.76	9.525		
	3185L				1.85	2.5	0.2	4.76	9.525		
	3200L				2.00	2.5	0.2	4.76	9.525		
	3230L				2.30	3.5	0.3	4.76	9.525		
	3280L				2.80	3.5	0.3	4.76	9.525		
	3330L				3.30	3.5	0.3	4.76	9.525		
	3430L				4.30	3.5	0.4	4.76	9.525		
	4125L				1.25	2.0	0.2	4.76	12.7		
	4145L				1.45	2.0	0.2	4.76	12.7		
	4150L				1.50	3.5	0.2	4.76	12.7		
	4175L				1.75	3.5	0.2	4.76	12.7		
	4185L				1.85	3.5	0.2	4.76	12.7		
	4200L				2.00	3.5	0.2	4.76	12.7		
	4215L				2.15	3.5	0.2	4.76	12.7		
	4230L				2.30	3.5	0.2	4.76	12.7		
	4250L				2.50	4.0	0.3	4.76	12.7		
	4265L				2.65	4.0	0.3	4.76	12.7		
	4280L				2.80	4.0	0.3	4.76	12.7		
	4300L				3.00	4.0	0.3	4.76	12.7		
	4330L				3.30	4.0	0.3	4.76	12.7		
	4350L				3.50	5.0	0.3	4.76	12.7		
	4400L				4.00	5.0	0.4	4.76	12.7		
	4430L				4.30	5.0	0.4	4.76	12.7		
	4450L				4.50	5.0	0.4	4.76	12.7		

● : Stock item



Insert

Picture	Designation	Cermet		Coated	Dimensions (mm)					Configuration
		CN2000	CN2500	PC5300	b	g (T-MAX)	r	w	d	
	TB (Right-handed)									
	4150R-M	●		●	1.50	3.5	0.20	4.76	12.7	
	4175R-M	●		●	1.75	3.5	0.20	4.76	12.7	
	4185R-M	●		●	1.85	3.5	0.20	4.76	12.7	
	4200R-M	●		●	2.00	3.5	0.20	4.76	12.7	
	4215R-M	●		●	2.15	3.5	0.20	4.76	12.7	
	4230R-M	●		●	2.30	3.5	0.20	4.76	12.7	
	4250R-M	●		●	2.50	4.0	0.30	4.76	12.7	
	4265R-M	●		●	2.65	4.0	0.30	4.76	12.7	
	4280R-M	●		●	2.80	4.0	0.30	4.76	12.7	
	4300R-M	●		●	3.00	4.0	0.30	4.76	12.7	
	4330R-M			●	3.30	4.0	0.30	4.76	12.7	
	4350R-M	●		●	3.50	5.0	0.30	4.76	12.7	
	4400R-M	●		●	4.00	5.0	0.40	4.76	12.7	
	4430R-M	●		●	4.30	5.0	0.40	4.76	12.7	
4450R-M	●		●	4.50	5.0	0.40	4.76	12.7		
	TB (Neutral)									
	5050N-000-M			●	0.50	1.0	0.00	4.50	15.875	
	5050N-004-M			●	0.50	2.5	0.04	4.50	15.875	
	5080N-000-M			●	0.80	1.6	0.00	4.50	15.875	
	5100N-006-M			●	1.00	3.5	0.06	4.50	15.875	
	5104N-000-M			●	1.04	2.0	0.00	4.50	15.875	
	5120N-000-M			●	1.20	2.0	0.00	4.50	15.875	
	5140N-000-M			●	1.40	6.5	0.00	4.50	15.875	
	5147N-000-M			●	1.47	6.5	0.00	4.50	15.875	
	5150N-010-M			●	1.50	6.5	0.10	4.50	15.875	
	5150N-015-M			●	1.50	6.5	0.15	4.50	15.875	
	5157N-015-M			●	1.57	6.5	0.15	4.50	15.875	
	5170N-010-M			●	1.70	6.5	0.10	4.50	15.875	
	5178N-018-M			●	1.78	6.5	0.18	4.50	15.875	
	5196N-015-M			●	1.96	6.5	0.15	4.50	15.875	
	5200N-020-M			●	2.00	6.5	0.20	4.50	15.875	
	5222N-015-M			●	2.22	6.5	0.15	4.50	15.875	
	5230N-020-M			●	2.30	6.5	0.20	4.50	15.875	
	5239N-015-M			●	2.39	6.5	0.15	4.50	15.875	
	5247N-020-M			●	2.47	6.5	0.20	4.50	15.875	
5250N-020-M			●	2.50	6.5	0.20	4.50	15.875		
5270N-010-M			●	2.70	6.5	0.10	4.50	15.875		
5287N-020-M			●	2.87	6.5	0.20	4.50	15.875		
5300N-000-M			●	3.00	6.5	0.00	4.50	15.875		
5300N-020-M			●	3.00	6.5	0.20	4.50	15.875		
5300N-040-M			●	3.00	6.5	0.40	4.50	15.875		
5315N-015-M			●	3.15	6.5	0.15	4.50	15.875		
5318N-020-M			●	3.18	6.5	0.20	4.50	15.875		

● : Stock item



Insert

Picture	Designation	Cermet		Coated	Dimensions (mm)						Configuration
		CN2000	CN2500	PC5300	b	g (T-Max)	r	a°	w	d	
	TB 5050N-004-P				0.50	1.0	0.04	-	4.50	15.875	
	(Neutral) 5100N-010-P				1.00	3.5	0.10	-	4.50	15.875	
	5150N-010-P				1.50	6.5	0.10	-	4.50	15.875	
	020-P				1.50	6.5	0.20	-	4.50	15.875	
	5200N-010-P				2.00	6.5	0.10	-	4.50	15.875	
	020-P				2.00	6.5	0.20	-	4.50	15.875	
	5239N-015-P				2.39	6.5	0.15	-	4.50	15.875	
	5250N-020-P				2.50	6.5	0.20	-	4.50	15.875	
5300N-020-P				3.00	6.5	0.20	-	4.50	15.875		
	TB 5100N-6DR-P				1.00	3.5	0.05	6	4.50	15.875	
	(Neutral, Right cutting) 15DR-P				1.00	3.5	0.05	15	4.50	15.875	
	5150N-6DR-P				1.50	6.5	0.05	6	4.50	15.875	
	15DR-P				1.50	6.5	0.05	15	4.50	15.875	
	5200N-6DR-P				2.00	6.5	0.10	6	4.50	15.875	
	15DR-P				2.00	6.5	0.10	15	4.50	15.875	
	TB 5100N-6DL-P				1.00	3.5	0.05	6	4.50	15.875	
	(Neutral, Left cutting) 15DL-P				1.00	3.5	0.05	15	4.50	15.875	
	5150N-6DL-P				1.50	6.5	0.05	6	4.50	15.875	
	15DL-P				1.50	6.5	0.05	15	4.50	15.875	
	5200N-6DL-P				2.00	6.5	0.10	6	4.50	15.875	
	15DL-P				2.00	6.5	0.10	15	4.50	15.875	
	TB 5157N-079-P				1.57	6.5	0.79	-	4.50	15.875	
	(Neutral, Round shape) 5200N-100-P				2.00	6.5	1.00	-	4.50	15.875	
	5239N-120-P				2.39	6.5	1.20	-	4.50	15.875	
	5300N-150-P				3.00	6.5	1.50	-	4.50	15.875	

● : Stock item



TBH

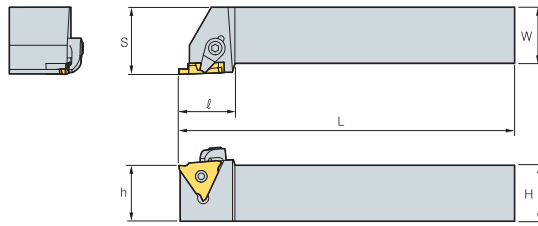
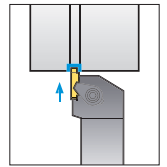


Fig. 1



• R type insert

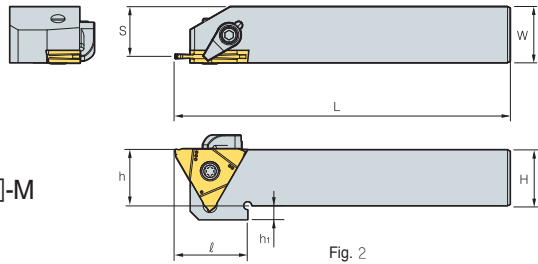
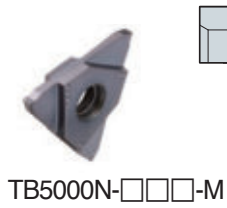


Fig. 2

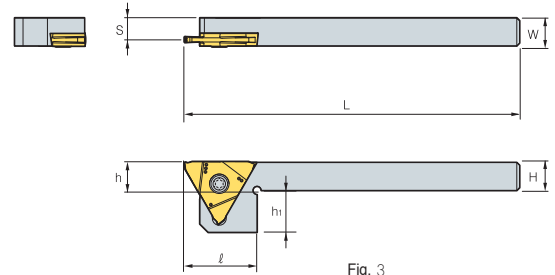


Fig. 3

(mm)

Designation	Dimensions							Inserts	Clamp	Clamp Screw	Screw	Wrench	Fig.
	H = (h)	W	L	ℓ	h ₁	S							
TBH	320R/L-23	20	20	125	25.5	-	25	TB3125~3230R/L	CS6R1	DHA0617	-	HW30L	1
	320R/L-33	20	20	125	25.5	-	25	TB3280~3330R/L					
	320R/L-43	20	20	125	25.5	-	25	TB3430R/L					
	325R/L-23	25	25	150	25.5	-	30	TB3125~3230R/L					
	325R/L-33	25	25	150	25.5	-	30	TB3280~3330R/L					
	325R/L-43	25	25	150	25.5	-	30	TB3430R/L					
	420R/L-23	20	20	125	25.5	-	25	TB4125~4230R/L					
	420R/L-33	20	20	125	25.5	-	25	TB4250~4330R/L					
	420R/L-45	20	20	125	25.5	-	25	TB4350~4450R/L					
	425R/L-23	25	25	150	25.5	-	30	TB4125~4230R/L					
	425R/L-33	25	25	150	25.5	-	30	TB4250~4330R/L					
	425R/L-45	25	25	150	25.5	-	30	TB4350~4450R/L					
TBH	510R/L	10	10	125	25	15	7.8	TB5050~5318N	-	-	FTNA0512	TW20L	3
	512R/L	12	12	125	25	13	9.8						
	516R/L	16	16	125	26	9	13.8						
	520R/L	20	20	125	26	5	17.8						
	525R/L	25	25	150	-	-	22.8		CS6R1	DHA0617	FTNA0516	HW30L, TW20L	2

The Solution for High-Precision Grooving

K Notch

KORLOY Grooving Tool

- KORLOY clamping system offers high rigidity for high precision machining
- High-quality cutting edge ensuring long tool life and excellent machinability
- Provides various cutting edge widths for a wide range of selection

Code system

• Insert

KN	G	P	3	M	200	R
K Notch	Insert type	Additional information	Insert size	Unit	Insert Width	Hand
	B: Blank G: Grooving R: Full Radius T: Threading	P: Positive None: Flat	2, 3, 4	M: Metric None: Inch	200: 2.00 mm	L: Left R: Right


• Holder

KN	S	R	25 25	M	3
K Notch	Clamping position	Hand	Shank size	Holder length	Insert size
	S: Side	L: Left R: Right	Height: 25 mm Width: 25 mm	E: 70 mm K: 125 mm F: 80 mm M: 150 mm H: 100 mm P: 170 mm	8~36 mm

Features of holder

Clamp

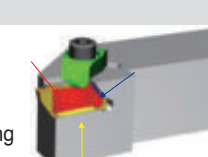
- Rigid binding force relative to the clamping force
- User-oriented convenient shape



Clamped view

Insert clamping


- Provides excellent clamping stability due to the 3-face (bottom, side, and rear face) binding

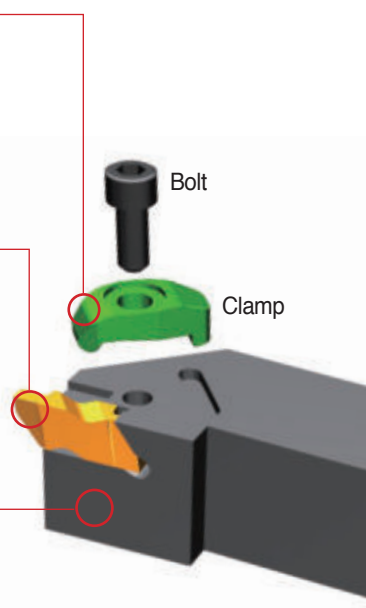


3-face clamping

Relief angle

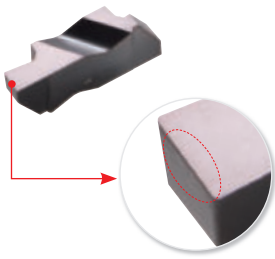
- The relief angle of a flank surface when clamping an insert: 3°





C Technical Information for K Notch

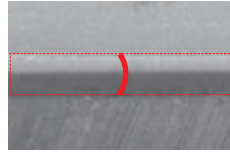
Features of insert



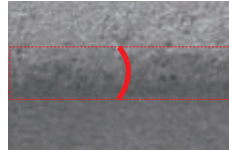
[Edge preparation]

High-quality edge preparation

- Cutting edges in uniform quality
- Long tool life



[K Notch]



[Competitor]

Mirror-like rake surface

- Improved resistance to welding and chipping
- Improved surface finish of workpieces



[K Notch]

Recommended feed per insert type

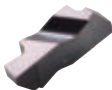
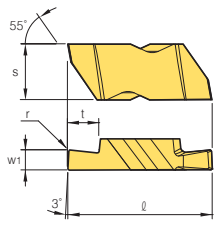
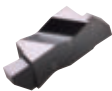
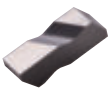
Type		KNG	KNGP	KNR	KNRP	KNB
Insert shape						
Cutting-edge						
Application		General grooving	General grooving	Turning profiling	Turning profiling	Blank
Recommended workpiece	1st	P, K	M, N, S	P, K	M, N, S	-
	2nd	M, N, S	P, K	M, N, S	P, K	-
Recommended feed, f_n (mm/rev)	P	0.10 - 0.28	0.08 - 0.25	0.10 - 0.28	0.08 - 0.25	-
	M	0.10 - 0.25	0.08 - 0.25	0.10 - 0.25	0.08 - 0.25	-
	K	0.10 - 0.28	0.08 - 0.25	0.10 - 0.28	0.08 - 0.25	-
	N	0.01 - 0.30	0.01 - 0.30	0.01 - 0.30	0.01 - 0.30	-
	S	0.05 - 0.15	0.05 - 0.15	0.05 - 0.15	0.05 - 0.15	-

Recommended cutting speed per grade

Workpiece	Grade	Recommended cutting speed, v_c (m/min)				
		50	100	200	300	600
P Steel	PC5300		80	200		
	Alloy steel	60	160			
M Stainless steel	PC5300		80	130		
	PC8110		80	160		
K Cast iron	PC5300		90	200		
N Non-ferrous metal	PC5300			150		600
S Heat-resistant alloy	PC8110	35	65			


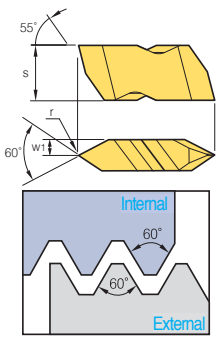


Insert (Metric)

Application	Picture	Designation	Coated			Dimensions										Configuration
			PC5300	PC8110	Uncoated	mm					inch					
						s	w ₁	r	t	ℓ	s	w ₁	r	t	ℓ	
Flat Top		KNG 2M 150R				5.56	1.50	0.19	2.79	13.030	0.219	0.059	0.0075	0.11	0.513	
						5.56	2.00	0.19	2.79	13.030	0.219	0.079	0.0075	0.11	0.513	
						5.56	2.50	0.19	2.79	13.030	0.219	0.098	0.0075	0.11	0.513	
					5.56	3.00	0.19	2.79	13.030	0.219	0.118	0.0075	0.11	0.513		
		3M 150R	●	●	8.74	1.50	0.19	2.79	22.709	0.344	0.059	0.0075	0.075	0.894		
			●	●	8.74	2.00	0.19	2.79	22.709	0.344	0.079	0.0075	0.11	0.894		
			●	●	8.74	2.50	0.19	3.81	22.709	0.344	0.098	0.0075	0.15	0.894		
					8.74	3.00	0.19	3.81	22.709	0.344	0.118	0.0075	0.15	0.894		
		4M 500R			11.51	5.00	0.20	6.35	28.663	0.453	0.197	0.0079	0.25	1.128		
					11.51	6.00	0.20	6.35	28.663	0.453	0.236	0.0079	0.25	1.128		
					11.51	6.00	0.20	6.35	28.663	0.453	0.236	0.0079	0.25	1.128		
		C/B Ground		KNGP 2M 150R				5.56	1.50	0.19	2.79	13.030	0.219	0.059	0.0075	
						5.56	2.00	0.19	2.79	13.030	0.219	0.079	0.0075	0.11	0.513	
						5.56	2.50	0.19	2.79	13.030	0.219	0.098	0.0075	0.11	0.513	
					5.56	3.00	0.19	2.79	13.030	0.219	0.118	0.0075	0.11	0.513		
3M 150R	●			●	8.74	1.50	0.19	2.79	22.709	0.344	0.059	0.0075	0.075	0.894		
	●			●	8.74	2.00	0.19	2.79	22.709	0.344	0.079	0.0075	0.11	0.894		
	●			●	8.74	2.50	0.19	3.81	22.709	0.344	0.098	0.0075	0.15	0.894		
					8.74	3.00	0.19	3.81	22.709	0.344	0.118	0.0075	0.15	0.894		
4M 500R					11.51	5.00	0.20	6.35	28.663	0.453	0.197	0.0079	0.25	1.128		
					11.51	6.00	0.20	6.35	28.663	0.453	0.236	0.0079	0.25	1.128		
					11.51	6.00	0.20	6.35	28.663	0.453	0.236	0.0079	0.25	1.128		
Blank				KNB 2R				5.56	3.81	-	-	13.030	0.219	0.150	-	-
						8.74	4.95	-	-	22.709	0.344	0.195	-	-	0.894	
						11.51	6.48	-	-	28.663	0.453	0.255	-	-	1.128	

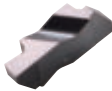
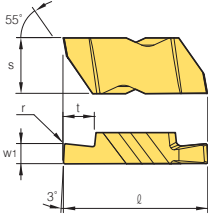
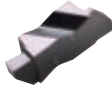
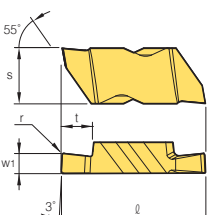

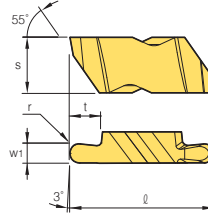
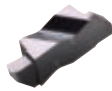
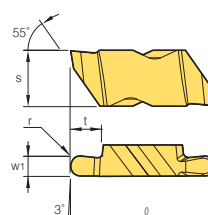
● : Stock item

Insert (Threading)

Application	Picture	Designation	Coated		Dimensions							Configuration	
			PC5300	PC8110	mm			inch			Pitch (External)		
					s	w ₁	r	s	w ₁	r	mm		tpi
Partial Profiling 60°		KNT 2R			5.56	3.81	0.10	0.219	0.150	0.004	0.70-3.00	8-36	
					8.74	4.95	0.17	0.344	0.195	0.007	1.25-4.00	6-20	
					11.51	6.48	0.17	0.453	0.255	0.007	1.25-6.25	4-20	

● : Stock item

Insert (Inch)

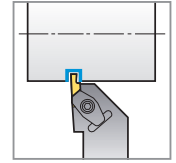
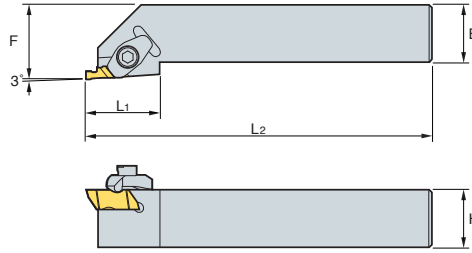
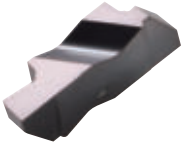
Application	Picture	Designation	Coated		Dimensions										Configuration
			PC5300	PC8110	mm					inch					
					s	w1	r	t	ℓ	s	w1	r	t	ℓ	
Flat Top		KNG	2031R		5.56	0.79	0.09	1.27	13.030	0.219	0.031	0.0035	0.05	0.513	
			2041R		5.56	1.04	0.09	1.27	13.030	0.219	0.041	0.0035	0.05	0.513	
			2047R		5.56	1.19	0.09	1.27	13.030	0.219	0.047	0.0035	0.05	0.513	
			2058R		5.56	1.47	0.19	1.27	13.030	0.219	0.058	0.0075	0.05	0.513	
			2062R		5.56	1.57	0.19	2.79	13.030	0.219	0.062	0.0075	0.11	0.513	
			2094R		5.56	2.39	0.19	2.79	13.030	0.219	0.094	0.0075	0.11	0.513	
			2125R		5.56	3.18	0.19	2.79	13.030	0.219	0.125	0.0075	0.11	0.513	
			3047R		8.74	1.19	0.19	1.91	22.709	0.344	0.047	0.0075	0.075	0.894	
			3062R	● ●	8.74	1.57	0.19	2.39	22.709	0.344	0.062	0.0075	0.094	0.894	
			3072R		8.74	1.83	0.19	2.39	22.709	0.344	0.072	0.0075	0.094	0.894	
			3078R	● ●	8.74	1.98	0.19	2.39	22.709	0.344	0.078	0.0075	0.094	0.894	
			3088R		8.74	2.24	0.19	2.39	22.709	0.344	0.088	0.0075	0.094	0.894	
			3094R		8.74	2.39	0.19	3.81	22.709	0.344	0.094	0.0075	0.15	0.894	
			3097R	● ●	8.74	2.46	0.32	3.81	22.709	0.344	0.097	0.0125	0.15	0.894	
			3105R		8.74	2.67	0.19	3.81	22.709	0.344	0.105	0.0075	0.15	0.894	
			3110R		8.74	2.79	0.32	3.81	22.709	0.344	0.110	0.0125	0.15	0.894	
			3122R		8.74	3.10	0.19	3.81	22.709	0.344	0.122	0.0075	0.15	0.894	
			3125R	● ●	8.74	3.18	0.19	3.81	22.709	0.344	0.125	0.0075	0.15	0.894	
			3142R		8.74	3.61	0.32	3.81	22.709	0.344	0.142	0.0125	0.15	0.894	
			3156R	● ●	8.74	3.96	0.19	3.81	22.709	0.344	0.156	0.0075	0.15	0.894	
			3178R		8.74	4.52	0.19	3.81	22.709	0.344	0.178	0.0075	0.15	0.894	
			3185R		8.74	4.70	0.57	3.81	22.709	0.344	0.185	0.0225	0.15	0.894	
			3189R	● ●	8.74	4.80	0.57	3.81	22.709	0.344	0.189	0.0225	0.15	0.894	
			4125R	● ●	11.51	3.18	0.19	3.81	28.663	0.453	0.125	0.0075	0.15	1.128	
			4189R		11.51	4.80	0.57	6.35	28.663	0.453	0.189	0.0225	0.25	1.128	
4213R		11.51	5.41	0.19	6.35	28.663	0.453	0.213	0.0075	0.25	1.128				
4219R		11.51	5.56	0.57	6.35	28.663	0.453	0.219	0.0225	0.25	1.128				
4250R		11.51	6.35	0.57	6.35	28.663	0.453	0.250	0.0225	0.25	1.128				
C/B Ground		KNGP	2031R		5.56	0.79	0.09	1.27	13.030	0.219	0.031	0.0035	0.05	0.513	
			2062R		5.56	1.57	0.19	2.79	13.030	0.219	0.062	0.0075	0.11	0.513	
			2125R		5.56	3.18	0.19	2.79	13.030	0.219	0.125	0.0075	0.11	0.513	
			3088R		8.74	2.24	0.19	2.39	22.709	0.344	0.088	0.0075	0.094	0.894	
			3125R	● ●	8.74	3.18	0.19	3.81	22.709	0.344	0.125	0.0075	0.15	0.894	
			3156R	● ●	8.74	3.96	0.19	3.81	22.709	0.344	0.156	0.0075	0.15	0.894	
			3189R		8.74	4.80	0.57	3.81	22.709	0.344	0.189	0.0225	0.15	0.894	
			4189R		11.51	4.80	0.57	6.35	28.663	0.453	0.189	0.0225	0.25	1.128	
			4250R		11.51	6.35	0.57	6.35	28.663	0.453	0.250	0.0225	0.25	1.128	
Round Flat Top		KNR	2031R		5.56	1.57	0.79	2.79	13.030	0.219	0.062	0.031	0.11	0.513	
			2047R		5.56	2.39	1.19	2.79	13.030	0.219	0.094	0.047	0.11	0.513	
			3031R	● ●	8.74	1.57	0.79	2.39	22.709	0.344	0.062	0.031	0.094	0.894	
			3047R	● ●	8.74	2.39	1.19	3.81	22.709	0.344	0.094	0.047	0.15	0.894	
			3062R	● ●	8.74	3.18	1.59	3.81	22.709	0.344	0.125	0.0625	0.15	0.894	
			3078R	● ●	8.74	3.96	1.98	3.81	22.709	0.344	0.156	0.078	0.15	0.894	
			3094R	● ●	8.74	4.78	2.39	3.81	22.709	0.344	0.188	0.094	0.15	0.894	
			4125R		11.51	6.35	3.18	6.35	28.663	0.453	0.250	0.125	0.25	1.128	
Round C/B Ground		KNRP	2031R		5.56	1.57	0.79	2.79	13.030	0.219	0.062	0.031	0.11	0.513	
			2047R		5.56	2.39	1.19	2.79	13.030	0.219	0.094	0.047	0.11	0.513	
			3031R	● ●	8.74	1.57	0.79	2.39	22.709	0.344	0.062	0.031	0.094	0.894	
			3047R	● ●	8.74	2.39	1.19	3.81	22.709	0.344	0.094	0.047	0.15	0.894	
			3062R	● ●	8.74	3.18	1.59	3.81	22.709	0.344	0.125	0.0625	0.15	0.894	
			3078R	● ●	8.74	3.96	1.98	3.81	22.709	0.344	0.156	0.078	0.15	0.894	
			3094R	● ●	8.74	4.78	2.39	3.81	22.709	0.344	0.188	0.094	0.15	0.894	
			4125R		11.51	6.35	3.18	6.35	28.663	0.453	0.250	0.125	0.25	1.128	

● : Stock item






KNSR

For grooving, profil machining



KNG KNGP KNT
KNR KNRP KNB

Designation	mm					inch					Insert	Clamp 	Screw 	Wrench 	
	H	B	F	L1	L2	H	B	F	L1	L2					
KNSR	1010E2	10	10	14	19	70	0.394	0.394	0.551	0.748	2.756	KNG2□ KNGP2□ KNR2□ KNB2R KNT2R	CM74	MHB3010	HW25L
	1212F2	12	12	16	19	80	0.472	0.472	0.630	0.748	3.150				
	1616H2	16	16	20	19	100	0.630	0.630	0.787	0.748	3.937				
	2020K2	20	20	25	19	125	0.787	0.787	0.984	0.748	4.921				
	2525M2	25	25	32	19	150	0.984	0.984	1.260	0.748	5.906				
	2020K3	20	20	25	32	125	0.787	0.787	0.984	1.260	4.921				
	2525M3	25	25	32	32	150	0.984	0.984	1.260	1.260	5.906				
	3225P3	32	32	32	32	170	1.260	1.260	1.260	1.260	6.693				
	3232P3	32	32	40	32	170	1.260	1.260	1.575	1.260	6.693				
	2525M4	25	25	32	35	150	0.984	0.984	1.260	1.378	5.906				
3225P4	32	32	32	35	170	1.260	1.260	1.260	1.378	6.693	KNG4□ KNGP4□ KNR4□ KNB4R KNT4R	CM72LP	MHA0512	HW40L	
3232P4	32	32	40	35	170	1.260	1.260	1.575	1.378	6.693					



For deep hole grooving/parting off

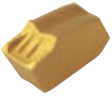
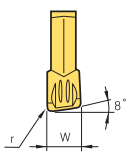
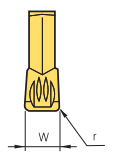
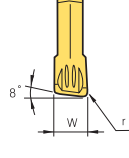
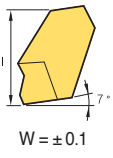
Saw Man

Features of parting insert

- Possible to machine a wide range of workpieces such as steel, cast iron, stainless steel, etc.
- Extended tool life due to low resistance rake angle
- Minimized burr due to minimal Nose R
- Various lead angle available
- Narrow chip curl due to dots on rake surface of insert

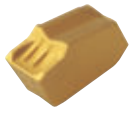
Workpiece	Cutting Speed (vc = m/min)								Feed (fn = mm/rev)				
	CVD				PVD			Uncoated	Cutting width (mm)				
	NC3120	NC3030	NCM325	NC5330	PC8110	PC5300	PC6510		ST30A	2	3	4	5
SM□□C	80~180			80~180		80~180			0.02~0.15	0.03~0.20	0.08~0.30	0.10~0.4	0.12~0.50
SCM	70~150	70~150	70~150	70~150		70~150			0.02~0.15	0.03~0.20	0.08~0.30	0.10~0.4	0.12~0.50
GC/GCD				50~100			50~100	50~100	0.05~0.12	0.10~0.25	0.10~0.30	0.10~0.35	0.10~0.40
STS			50~120	50~120	50~120	60~140			0.02~0.10	0.03~0.15	0.08~0.25	0.10~0.35	0.12~0.40
Non-ferrous metal (Al, Copper)								200~450	0.05~0.10	0.05~0.20	0.05~0.25	0.05~0.30	0.05~0.35

Insert

Application	Picture	Designation	Coated										Uncoated	Dimensions (mm)			Configuration
			NC3120	NC3225	NC3030	NCM325	NC5330	PC3035	PC8105	PC8110	PC5300	PC9030		ST30A	W	l	
Parting tools		SP 160												1.6	7.8	0.16	<div style="display: flex; justify-content: space-around;"> <div style="text-align: center;"> <p>R type</p>  </div> <div style="text-align: center;"> <p>Standard</p>  </div> </div> <div style="margin-top: 20px;"> <p>L type</p>  </div> <div style="margin-top: 20px;">  <p>W = ± 0.1</p> </div>
		SP 180												1.8	9.3	0.16	
		SP 200		●	●	●	●			●	●	●		2.2	9.3	0.2	
		SP 200R			●							●		2.2	9.3	0.2	
		SP 200L										●		2.2	9.3	0.2	
		SP 300		●	●	●	●	●		●	●	●	●	3.1	11.3	0.2	
		SP 300R			●	●	●			●				3.1	11.3	0.2	
		SP 300L				●								3.1	11.3	0.2	
		SP 400		●	●	●	●	●		●	●	●		4.1	11.3	0.25	
		SP 400R				●				●				4.1	11.3	0.25	
		SP 400L				●								4.1	11.3	0.25	
		SP 500				●	●	●		●	●			5.1	11.4	0.3	
		SP 500R												5.1	11.4	0.3	
		SP 500L												5.1	11.4	0.3	
		SP 600				●		●			●			6.4	11.4	0.35	
		SP 600R												6.4	11.4	0.35	
SP 600L												6.4	11.4	0.35			
SP 800												8.0	14.06	0.4			
SP 900												9.6	14.06	0.45			

● : Stock item

SPB/SPB-S (Blades)



SP

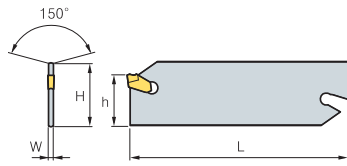


Fig. 1

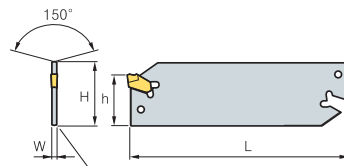
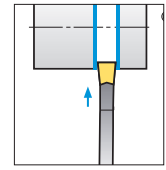


Fig. 2



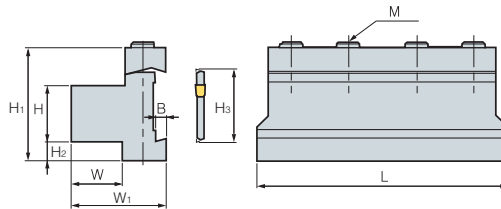
Designation		H	W	L	h	Inserts	Wrench	Fig.
SPB	226	26	1.6	110	21	SP200, 200R/L	SW50L	1
	232	32	1.6	150	25	SP200, 200R/L		
	326	26	2.4	110	21	SP300, 300R/L		
	332	32	2.4	150	25	SP300, 300R/L		
	426	26	3.2	110	21	SP400, 400R/L		
	432	32	3.2	150	25	SP400, 400R/L		
	526	26	4.0	110	21	SP500, 500R/L		
	532	32	4.0	150	25	SP500, 500R/L		
	626	26	5.2	110	21	SP600, 600R/L		
	632	32	5.2	150	25	SP600, 600R/L		
SPB-S	226-S	26	1.6	110	21	SP200, 200R/L	SW15S (Separately ordered)	2
	232-S	32	1.6	150	25	SP200, 200R/L		
	326-S	26	2.4	110	21	SP300, 300R/L		
	332-S	32	2.4	150	25	SP300, 300R/L		
	426-S	26	3.2	110	21	SP400, 400R/L		
	432-S	32	3.2	150	25	SP400, 400R/L		
	526-S	26	4.0	110	21	SP500, 500R/L		
	532-S	32	4.0	150	25	SP500, 500R/L		
	626-S	26	5.2	110	21	SP600, 600R/L		
	632-S	32	5.2	150	25	SP600, 600R/L		
	832-S	32	6.8	150	25	SP800		
	932-S	32	8	150	25	SP900		
	8526-S	52.6	6.8	150	45	SP800		
	9526-S	52.6	8	150	45	SP900		

↻ Applicable inserts C60

SMBB (Block)



SPB□□□(-S)
KGTB□□□32



Designation		H	W	H ₃	L	H ₁	H ₂	W ₁	B	M	Blades	Wrench
SMBB	1626	16	12	26	86	43	13	30	5.3	3-M6	SPB□□26(-S) SPB□□32(-S) KGTB□□□32	HW50L
	2026	20	19	26	86	43	9	38	5.3	3-M6		
	2032	20	19	32	100	50	13	38	5.3	4-M6		
	2526	25	23	26	86	43	4	42	5.3	4-M6		
	2532	25	23	32	110	50	8	42	5.3	4-M6		
	3232	32	30	32	110	54	5	48	5.3	4-M6		
	40526	40	41	52.6	130	81.73	22	66	8	4-M8		

↻ Applicable inserts C60



SPH/SPH-S (Holder)



SP

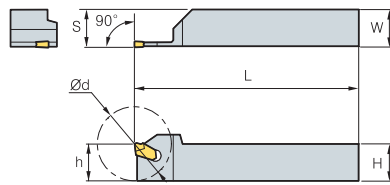


Fig. 1

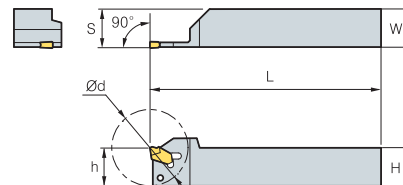
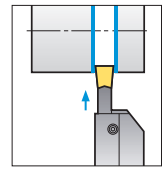



Fig. 2



• R type insert

(mm)

Designation		H = (h)	W	L	Ød	S	Inserts	Wrench	Fig.
SPH	316R/L	16	16	100	32	16.3	SP300, 300R/L	SW50L -	1
	320R/L	20	20	120	40	20.3	SP300, 300R/L		
	325R/L	25	25	150	50	25.3	SP300, 300R/L		
	420R/L	20	20	120	50	20.4	SP400, 400R/L		
	425R/L	25	25	150	60	25.4	SP400, 400R/L		
	520R/L	20	20	120	60	20.5	SP500, 500R/L		
	525R/L	25	25	150	70	25.5	SP500, 500R/L		
SPH-S	316R/L-S	16	16	100	32	16.3	SP300, 300R/L	- SW15S (Separately ordered)	2
	320R/L-S	20	20	120	40	20.3	SP300, 300R/L		
	325R/L-S	25	25	150	50	25.3	SP300, 300R/L		
	420R/L-S	20	20	120	50	20.4	SP400, 400R/L		
	425R/L-S	25	25	150	60	25.4	SP400, 400R/L		
	520R/L-S	20	20	120	60	20.5	SP500, 500R/L		
	525R/L-S	25	25	150	70	25.5	SP500, 500R/L		

 Applicable inserts C60

A solution for parting and deep grooving

Saw Man-X

- Stable machining in deep grooving applying clamping system with strong three-way V-Rail
- Improved clamping precision and convenient replacing of inserts with using the exclusive wrench

Code system

• Insert

KSP **300** - **020** - **N**

KORLOY Saw Man-X Parting **Cutting edge width** **Nose r** **Chip breaker**

200: 2 mm 020: 0.2 mm N: Negaland
 300: 3 mm 030: 0.3 mm
 400: 4 mm

• Shank

KSPH **3** **25** **R**

KORLOY Saw Man-X Parting Holder **Cutting edge width** **Shank size** **Hand**

2: 2 mm 16: 1616 R: Right
 3: 3 mm 20: 2020 L: Left
 4: 4 mm 25: 2525

• Blade

KSPB **30** **26**

KORLOY Saw Man-X Parting Blade **Cutting edge width** **Blade height**

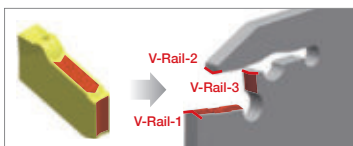
20: 2 mm 26: 26 mm
 30: 3 mm 32: 32 mm
 40: 4 mm

Features

- Three-way V-Rail – More stable clamping system
- New treatment on cutting edge – Better quality of machining and longer tool life
- Superior chip breaker – Better chip control
- Exclusive wrench – More convenient clamping system

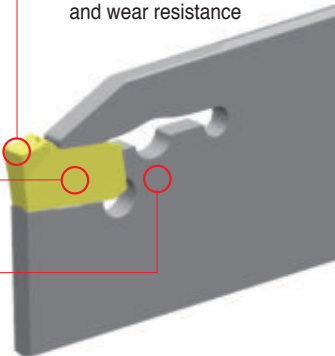
Three-way V-RAIL

- An insert is tightly clamped in the tip seat.
- Minimized vibration during the machining increases stability.
- Stable high speed, high feed and high depth of cut machining is available.



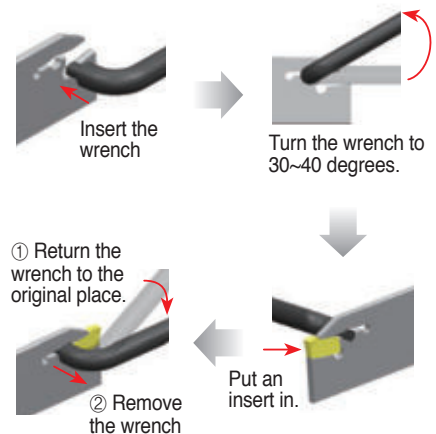
Special cutting edge

- Even cutting edge improves machinability
- Higher quality of machining and wear resistance



Exclusive wrench

- The exclusive wrench having the principle of CAM for the Saw Man-X
- More convenient clamping system



Features of chip breaker

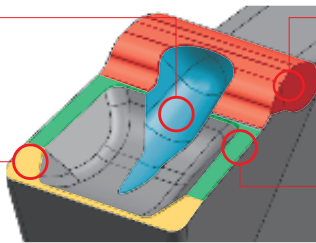
- The design of chip breaker and its bump in the back area realize better chip evacuation
- The chip breaker with negaland is used universally

Coolant path and guide for chip evacuation

- Inner coolant holder is available
- Guide for chip evacuation

Negaland

- Applying for various workpieces
- Stable in interrupted cutting and machining with high depth of cut



The second chip breaker in the back area

- Better chip control in machining of workpiece with a bigger diameter
- Preventing damage to holder from chip evacuation

Strong land on flank

- Smaller diameter of chip curl makes better chip control
- Higher rigidity of insert

Recommended cutting conditions

Workpiece					Grade	Cutting conditions	
ISO	Workpiece	KS	AISI	ISO (DIN)		vc (m/min)	fn (mm/rev)
P	Carbon steel	SM45C	1045	C45	PC5300	80-200	0.08-0.28
					PC3035	80-220	0.08-0.28
	Alloy steel	SCM440	4140	42CrMo4 (42CrMo4)	PC5300	80-160	0.08-0.25
					PC3035	80-180	0.08-0.25
M	Stainless steel	STS304	304	X5CrNi18-9 (X2CrNi19-11)	PC5300	80-190	0.06-0.20
		STS316	316	X5CrNiMo17-12-2	PC5300	80-190	0.06-0.20
K	Gray cast iron	GC250	No35B	250 (GG25)	PC8110	100-220	0.10-0.28
					PC5300	100-200	0.10-0.28
	Nodular graphite cast iron	GCD500	80-55-06	450-10	PC8110	80-200	0.10-0.25
					PC5300	80-180	0.10-0.25
S	HRSA	Inconel 718	7718	15156-3	PC8110	35-65	0.05-0.15
					PC5300	25-55	0.05-0.15


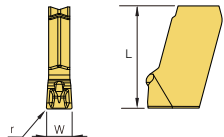
Cutting edge width and T-MAX by items

⊙: First recommendation ○: Second recommendation

Shape	Cutting edge width (mm)	T-MAX (mm)					No. of corner	Machining				Features	
		2	4	6	8	130		External diameter	Internal diameter	Cross section	Parting		
Saw Man-X ^{new}	2.0	6.0					1	○			⊙	• Self clamping • Deep grooving	
MGT, KGT	1.5	8.0					2	⊙	○	○	○	• Various machining • Wide range of machining	
TB	1.25	6.0					3	⊙			○	• Precise ground class • Optimally automatic machining	
Auto tools	Blade type	0.7	2.0					2	⊙			○	• For swiss-type lathe (blade) • Small deliberate component machining
	Multi-functional type	1.0	4.0					2	⊙			○	• For swiss-type lathe (multifunctional) • Small deliberate component machining
K Notch	0.75	6.3					2	⊙				• Strong clamping system • Highly qualified cutting edge	

Insert

(mm)

Application	Picture	Designation	Coated			W	r	L	Configuration
			PC3035	PC5300	PC8110				
Parting		KSP 200-020-N	●	●	●	2.0	0.20	11.0	
		300-020-N	●	●	●	3.0	0.20	12.0	
		400-025-N	●	●	●	4.0	0.25	12.5	
		500-025-N	●	●		5.0	0.25	13.5	
		600-035-N	●	●		6.0	0.35	14.5	

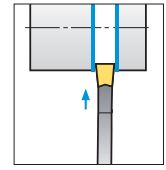
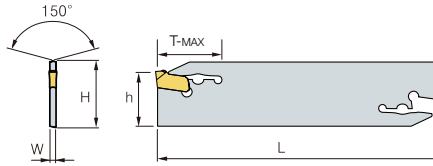
●: Stock item



KSPB (Blades)




KSP



(mm)

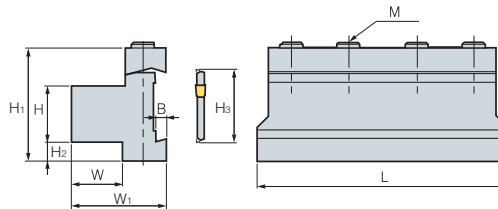
Designation		Cutting edge width	H	W	L	h	T-MAX	Wrench
KSPB	2026	2	26	1.6	110	21	25	CW08
	2032	2	32	1.6	150	25	26	
	3026	3	26	2.4	110	21	36	
	3032	3	32	2.4	150	25	60	
	4026	4	26	3.2	110	21	36	
	4032	4	32	3.2	150	25	60	
	5026	5	26	4.0	110	21	40	CW10
	5032	5	32	4.0	150	25	60	
	6026	6	26	5.2	110	21	60	
	6032	6	32	5.2	150	25	60	

 Applicable inserts C64

SMBB (Block)




KSPB□□□□
 SPB□□□(-S)
 KGTB□□□□



(mm)

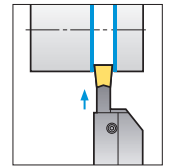
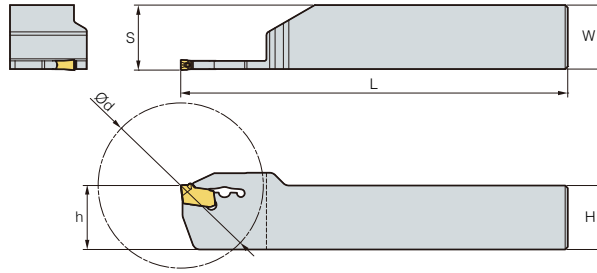
Designation		H	W	H3	L	H1	H2	W1	B	M	Wrench
SMBB	1626	16	12	26	86	43	13	30	5.3	3-M6	HW50L
	2026	20	19	26	86	43	9	38	5.3	3-M6	
	2032	20	19	32	100	50	13	38	5.3	4-M6	
	2526	25	23	26	86	43	4	42	5.3	4-M6	
	2532	25	23	32	110	50	8	42	5.3	4-M6	
	3232	32	30	32	110	54	5	48	5.3	4-M6	

 Applicable inserts C64

KSPH (Shank)




KSP



(mm)

Designation	Cutting edge width	H	W	L	Ød	S	Wrench
KSPH	216R/L	2	16	16	100	46	CW08
	220R/L	2	20	20	120	48	
	225R/L	2	25	25	150	50	
	316R/L	3	16	16	100	52	
	320R/L	3	20	20	120	54	
	325R/L	3	25	25	150	56	
	420R/L	4	20	20	120	64	
	425R/L	4	25	25	150	66	
	520R/L	5	20	20	120	74	
525R/L	5	25	25	150	76		
625R/L	6	25	25	150	76		

 Applicable inserts C64

Six kinds of inserts can be used in one holder for various operations

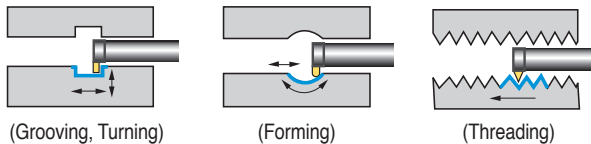
Fine Tools

- Strong clamping system and specially designed insert are suitable for small diameter machining
- Six kinds of inserts can be clamped in one holder for various operations
- Guaranteed long tool life due to good toughness substrate with new TiAlN
- High accuracy ground insert ensures high precision machining



➤ **Application range** • Internal grooving, Profiling, Threading and Boring at Ø8 mm~Ø16 mm

➤ **Features**



➤ **Code system**

NFTIH 08 3 12 - S

Minimum Diameter Overhang (l/ØD) Shank Dia. Shank Type

S: Steel, C: Carbide

➤ **Recommended cutting condition**

Workpiece	Grade (PC130)	Cutting Condition				
		Min. machining Dia. (ØDmin)				
		Ø8	Ø11	Ø14	Ø16	
Carbon steel	◎	vc (m/min)	70~120	70~120	70~120	70~120
		fn (mm/rev)	0.01~0.04	0.01~0.05	0.02~0.05	0.02~0.06
Alloy steel	◎	vc (m/min)	70~120	70~120	70~120	70~120
		fn (mm/rev)	0.01~0.02	0.01~0.04	0.02~0.04	0.02~0.05
Cast iron	○	vc (m/min)	60~100	60~100	60~100	60~100
		fn (mm/rev)	0.01~0.05	0.01~0.05	0.02~0.05	0.02~0.05
Non-ferrous alloy	○	vc (m/min)	100~180	100~180	100~180	100~180
		fn (mm/rev)	0.02~0.06	0.02~0.06	0.02~0.06	0.02~0.06

Note - In case of chattering, reduce the cutting speed and feed
 - To find the optimal cutting conditions, advise to gradually increase from the lowest cutting condition of the above recommendation
 - In case of the unilateral grooving depth over 1 mm, work to the step feed rate

➤ **Clamping system**

Screw **Insert** **Holder**

R Type L Type

Grooving Forming Threading

Shank (Cemented carbide or Steel)

Overhang (3D, 4D, 5D)



• Available R/L type insert with one holder

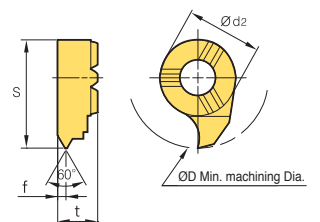
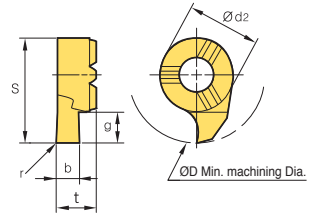
Stable clamping according to the tripod structure

R Type L Type

No-Spin-System design for strong clamping

Insert

Application	Picture	Designation	Coated		Dimensions (mm)									Configuration
			PC5300		ØD	b	r	S	g	Ød ₂	t	Pitch	f	
			R	L										
Internal grooving		NFTG 08075R/L	●		8	0.75	-	7.75	1.3	5.9	3.85	-	-	
		08085R/L	●		8	0.85	-	7.75	1.3	5.9	3.85	-	-	
		08095R/L	●		8	0.95	-	7.75	1.3	5.9	3.85	-	-	
		08121R/L	●		8	1.21	-	7.75	1.3	5.9	3.85	-	-	
		08141R/L	●		8	1.41	-	7.75	1.3	5.9	3.85	-	-	
		08152R/L	●		8	1.52	-	7.75	1.3	5.9	3.85	-	-	
		08171R/L	●		8	1.71	-	7.75	1.3	5.9	3.85	-	-	
		08202R/L	●		8	2.02	-	7.75	1.3	5.9	3.85	-	-	
		11075R/L	●		11	0.75	-	10.7	1.8	8.0	4.9	-	-	
		11085R/L	●		11	0.85	-	10.7	1.8	8.0	4.9	-	-	
		11095R/L	●		11	0.95	-	10.7	1.8	8.0	4.9	-	-	
		11121R/L	●		11	1.21	-	10.7	2.6	8.0	4.9	-	-	
		11141R/L	●		11	1.41	-	10.7	2.6	8.0	4.9	-	-	
		11152 R/L	●		11	1.52	-	10.7	2.6	8.0	4.9	-	-	
		11171R/L	●		11	1.71	-	10.7	2.6	8.0	4.9	-	-	
		11202R/L	●		11	2.02	-	10.7	2.6	8.0	4.9	-	-	
		11202R/L-02	●		11	2.02	0.2	10.7	2.6	8.0	4.9	-	-	
		11252R/L	●		11	2.52	-	10.7	2.6	8.0	4.9	-	-	
		11302R/L	●		11	3.02	-	10.7	2.6	8.0	4.9	-	-	
		14075R/L	●		14	0.75	-	13.5	1.8	9.0	5.85	-	-	
		14085R/L	●		14	0.85	-	13.5	1.8	9.0	5.85	-	-	
		14095R/L	●		14	0.95	-	13.5	1.8	9.0	5.85	-	-	
		14121R/L	●		14	1.21	-	13.5	4.3	9.0	5.85	-	-	
		14141R/L	●		14	1.41	-	13.5	4.3	9.0	5.85	-	-	
		14152R/L	●		14	1.52	-	13.5	4.3	9.0	5.85	-	-	
		14171R/L	●		14	1.71	-	13.5	4.3	9.0	5.85	-	-	
		14202R/L	●		14	2.02	-	13.5	4.3	9.0	5.85	-	-	
		14252R/L	●		14	2.52	-	13.5	4.3	9.0	5.85	-	-	
		14302R/L	●		14	3.02	-	13.5	4.3	9.0	5.85	-	-	
		16075R/L	●		16	0.75	-	15.7	1.8	11.0	5.8	-	-	
		16085R/L	●		16	0.85	-	15.7	1.8	11.0	5.8	-	-	
		16095R/L	●		16	0.95	-	15.7	1.8	11.0	5.8	-	-	
		16121R/L	●		16	1.21	-	15.7	4.6	11.0	5.8	-	-	
		16141R/L	●		16	1.41	-	15.7	4.6	11.0	5.8	-	-	
		16171R/L	●		16	1.71	-	15.7	4.6	11.0	5.8	-	-	
		16202R/L	●		16	2.02	-	15.7	4.6	11.0	5.8	-	-	
16252R/L	●		16	2.52	-	15.7	4.6	11.0	5.8	-	-			
16302R/L	●		16	3.02	-	15.7	4.6	11.0	5.8	-	-			
16352R/L	●		16	3.52	-	15.7	4.6	11.0	5.8	-	-			
16402R/L	●		16	4.02	-	15.7	4.6	11.0	5.8	-	-			
Threading		NFTT 0805MR/L	●		8	-	-	7.75	-	6.0	3.85	0.5	1.0	
		0810MR/L	●		8	-	-	7.75	-	6.0	3.85	1.0	1.0	
		0815MR/L	●		8	-	-	7.75	-	6.0	3.85	1.5	1.2	
		1110MR/L	●		11	-	-	10.7	-	8.0	4.9	1.0	1.2	
		1115MR/L	●		11	-	-	10.7	-	8.0	4.9	1.5	1.2	
		1120MR/L	●		11	-	-	10.7	-	8.0	4.9	2.0	1.2	
		1125MR/L	●		11	-	-	10.7	-	8.0	4.9	2.5	1.2	
		1410MR/L	●		14	-	-	13.5	-	9.0	5.85	1.0	1.2	
		1415MR/L	●		14	-	-	13.5	-	9.0	5.85	1.5	1.2	
		1420MR/L	●		14	-	-	13.5	-	9.0	5.85	2.0	1.2	
		1425MR/L	●		14	-	-	13.5	-	9.0	5.85	2.5	1.2	
		1610MR/L	●		16	-	-	15.7	-	11.0	5.8	1.0	1.2	
		1615MR/L	●		16	-	-	15.7	-	11.0	5.8	1.5	1.2	
		1620MR/L	●		16	-	-	15.7	-	11.0	5.8	2.0	1.2	
		1625MR/L	●		16	-	-	15.7	-	11.0	5.8	2.5	1.2	
		1630MR/L	●		16	-	-	15.7	-	11.0	5.8	3.0	1.5	
1635MR/L	●		16	-	-	15.7	-	11.0	5.8	3.5	1.6			
1640MR/L	●		16	-	-	15.7	-	11.0	5.8	4.0	1.8			



● : Stock item

Insert

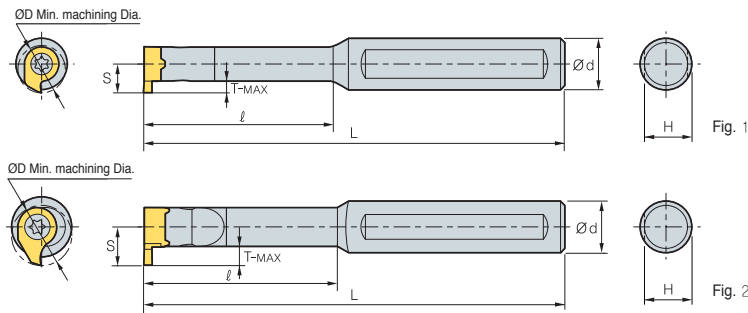
Application	Picture	Designation	Coated		Dimensions (mm)							Configuration
			PC5300		D	b	r	S	g	Ød ₂	t	
			R	L								
Profiling		NFTF 08082R/L	●		8	0.82	0.41	7.75	1.3	5.9	3.85	
		08122R/L	●		8	1.22	0.61	7.75	1.3	5.9	3.85	
		08182R/L	●		8	1.82	0.91	7.75	1.3	5.9	3.85	
		11082R/L	●		11	0.82	0.41	10.7	2.6	8	4.9	
		11122R/L	●		11	1.22	0.61	10.7	2.6	8	4.9	
		11182R/L	●		11	1.82	0.91	10.7	2.6	8	4.9	
		11202R/L	●		11	2.02	1.01	10.7	2.6	8	4.9	
		11302R/L	●		11	3.02	1.51	10.7	2.6	8	4.9	
		14122R/L	●		14	1.22	0.61	13.5	4.3	9	5.85	
		14182R/L	●		14	1.82	0.91	13.5	4.3	9	5.85	
		14202R/L	●		14	2.02	1.01	13.5	4.3	9	5.85	
		14222R/L	●		14	2.22	1.11	13.5	4.3	9	5.85	
		14302R/L	●		14	3.02	1.51	13.5	4.3	9	5.85	
		16182R/L	●		16	1.82	0.91	15.7	4.6	11	5.8	
		16222R/L	●		16	2.22	1.11	15.7	4.6	11	5.8	
		16302R/L	●		16	3.02	1.51	15.7	4.6	11	5.8	
		16402R/L	●		16	4.02	2.01	15.7	4.6	11	5.8	

● : Stock item

NFTIH



NFTF
NFTT
NFTG



- For NFTIH14 type

• R type insert (mm)

Designation	ØD	Ød	L	ℓ	T-MAX	H	S	Inserts		Screw	Wrench	Fig.
								NFTG: Grooving	NFTT: Threading			
NFTIH 08206C	8	6	65	-	1.0	4	4.8			PTKA02508	TW08P	1
08212C	8	12	70	16	1.0	10	4.8	NFTG08□□□R/L				
08312C	8	12	80	24	1.0	10	4.8	NFTT08□□□R/L				
08312S	8	12	80	24	1.0	10	4.8	NFTF08□□□R/L				
08412C	8	12	90	32	1.0	10	4.8			PTKA03510	TW15P	2
08512C	8	12	100	40	1.0	10	4.8	NFTG11□□□R/L				
11208C	11	8	80	-	2.3	7	6.7	NFTT11□□□R/L				
11212C	11	12	75	22	2.3	11	6.7	NFTF11□□□R/L				
11312C	11	12	95	33	2.3	11	6.7			PTKA0412	TW15P	2
11312S	11	12	95	33	2.3	11	6.7	NFTG14□□□R/L				
11412C	11	12	110	44	2.3	11	6.7	NFTT14□□□R/L				
11512C	11	12	120	55	2.3	11	6.7	NFTF14□□□R/L				
14012C	14	12	75	20	4.0	11	9.0			PTKA0512	TW20P	2
14016C	14	16	75	20	4.0	15	9.0	NFTG16□□□R/L				
14112C	14	12	100	34	4.0	11	9.0	NFTT16□□□R/L				
14116C	14	16	100	34	4.0	15	9.0	NFTF16□□□R/L				
14212C	14	12	110	45	4.0	11	9.0			PTKA0512	TW20P	2
14216C	14	16	110	45	4.0	15	9.0	NFTG16□□□R/L				
14312C	14	12	130	64	4.0	11	9.0	NFTT16□□□R/L				
14316C	14	16	130	64	4.0	15	9.0	NFTF16□□□R/L				
16312C	16	12	130	48	4.3	11	10.2			PTKA0512	TW20P	2
16312S	16	12	130	48	4.3	11	10.2	NFTG16□□□R/L				
16412C	16	12	130	64	4.3	11	10.2	NFTT16□□□R/L				
16512C	16	12	150	80	4.3	11	10.2	NFTF16□□□R/L				
16316C	16	16	130	48	4.3	15	10.2			PTKA0512	TW20P	2
16416C	16	16	130	64	4.3	15	10.2	NFTG16□□□R/L				
16516C	16	16	150	80	4.3	15	10.2	NFTT16□□□R/L				

Applicable inserts C68~C69

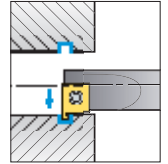
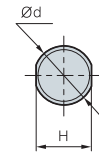
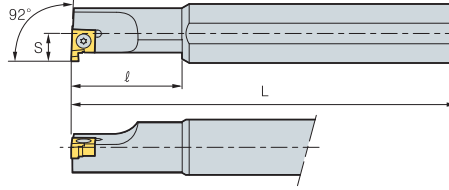
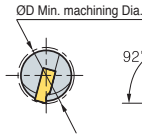


C Grooving Tools

IGH For internal grooving



IG



• R type insert

(mm)

Designation	ØD	Ød	H	L	l	S	Inserts	Screw	Wrench
IGH	214R	14	16	15	150	25	IG125~280	FTKA02565	TW07P
	216R	16	16	15	150	30			
	220R	20	20	18	200	40			

↻ Applicable inserts C70

Insert

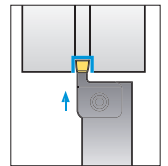
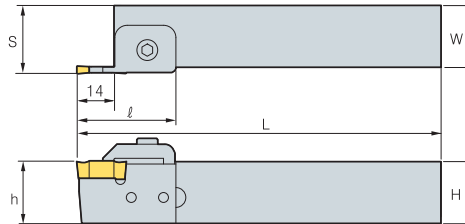
Application	Picture	Designation	Coated			Uncoated			Dimensions (mm)					Configuration	
			NC3215	NC3120	NC3225	H01	G10	ST30A	b	g	t	d	d ₁		
Internal grooving		IG 125R						●	1.25	1.5	3.18	6.35	2.8		
		145R						●	1.45	1.5	3.18	6.35	2.8		
		175R							●	1.75	1.5	3.18	6.35		2.8
		200R							●	2.0	2.3	3.18	6.35		2.8
		230R							●	2.3	2.3	3.18	6.35		2.8
		280R							●	2.8	2.3	3.18	6.35		2.8

● : Stock item

DBH For deep and wide grooving



DB DC



• R type insert

(mm)

Designation	H = (h)	W	L	l	S		Inserts		Clamp	Clamp Screw	Screw	Locator	Wrench		
					*	**	*	**							
DBH	320R	20	20	150	40	22.3	22.8	DB300	DB400	CGH5R1	MHA0512	MHB0410	LD34	HW30L	HW40L
	325R	25	25	150	40	27.3	27.8	DC300	DC400						
	520R	20	20	150	40	23.8	24.3	DB500	DB600						
	525R	25	25	150	40	28.8	29.3	DC500	DC500						
	720R	20	20	150	40	25.8	26.3	DB700	DB800						
	725R	25	25	150	40	30.8	31.3								

↻ Applicable inserts C70

Insert

Application	Picture	Designation	Cermet	Coated			Uncoated		Dimensions (mm)				Configuration	
				CN2000	NC3215	NC3120	NC3225	H01	G10	b	l	t		r
Grooving		DB 300							3.0	20	7.5	0.2		
		400							4.0	20	7.5	0.2		
		500								5.0	20	7.5		0.2
		600								6.0	20	7.5		0.2
		700								7.0	20	7.5		0.2
		800								8.0	20	7.5		0.2
		DC 300								3.0	20	7.5	0.2	
		400								4.0	20	7.5	0.25	
		500								5.0	20	7.5	0.3	

● : Stock item



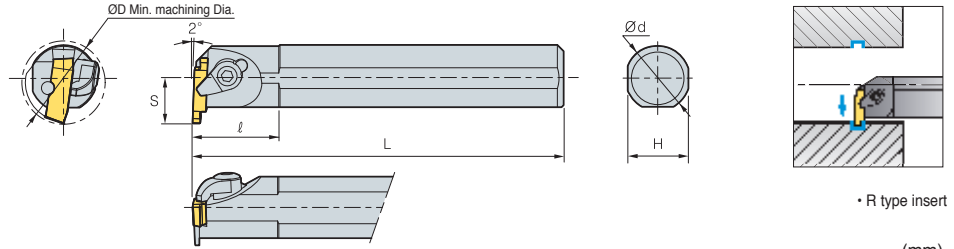
C

Multi functional Tools

GFIP For Internal grooving



BF GW



Designation	ØD	Ød	H	L	l	S	Inserts	Clamp	C-ring	Screw	Pin	Wrench
GFIP	316R/L	20	16	15	150	17	GW110~300R/L,BF3	CH5R2	CR04	CHX0513	PN0310	HW25L
	320R/L	26	20	18	150	22						
	325R/L	32	25	23	200	22						
	340R/L	50	40	37	300	32						
GFIP	525R/L	32	25	23	200	17	GW315~500R/L,BF5	CH6R2	CR05	CHX0616	PN0310	HW30L
	540R/L	50	40	37	300	32						
GFIP	840R/L	50	40	37	300	32	GW600~800R/L,BF8	CS8R1	-	DHA0820	PN0314	HW40L

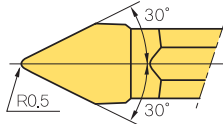
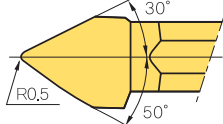
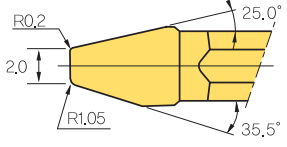
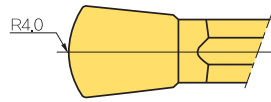
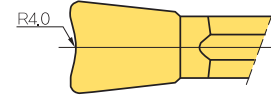
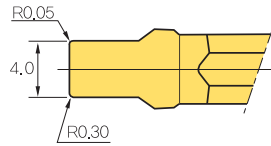
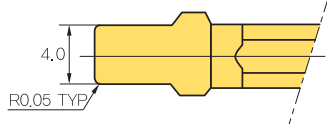
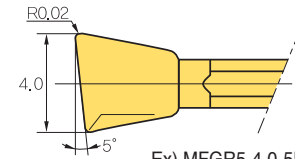
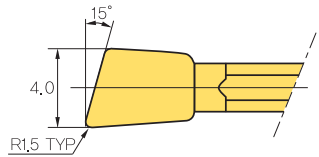
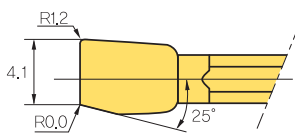
Applicable inserts C71 • Use right-hand insert for left-hand holder

Insert

Application	Picture	Designation	Uncoated		Dimensions (mm)						Configuration	
			ST30A		b	g	W	l	t	r		
Blank		BF	-3	●			3.1	16.4	5.26	-		
			-5				5.1	22.4	6.26	-		
			-8					8.1	27.4	7.26		-
Grooving		GW	110R/L	●	●	1.1	2.1	3.1	16	5.0	0.2	
			130R/L	●	●	1.3	2.3	3.1	16	5.0	0.2	
			160R/L	●	●	1.6	2.6	3.1	16	5.0	0.2	
			185R/L	●	●	1.85	2.9	3.1	16	5.0	0.2	
			215R/L	●	●	2.15	3.2	3.1	16	5.0	0.2	
			265R/L	●	●	2.65	3.7	3.1	16	5.0	0.2	
			300R/L	●	●	3.0	4.0	3.1	16	5.0	0.2	
			315R/L	●	●	3.15	4.2	5.1	22	6.0	0.3	
			415R/L		●	4.15	5.2	5.1	22	6.0	0.3	
			500R/L			5.0	6.0	5.1	22	6.0	0.3	
			600R/L			6.0	7.0	8.1	27	7.0	0.3	
			800R/L			8.0	9.0	8.1	27	7.0	0.3	

● : Stock item

C Special Order Form for MGT

Code system	Configuration
<p>M F G N 4 - 0.5R - 30D</p> <p>① ② ③ ④ ⑤ ⑥ ⑦</p> <p>① Multi ② Forming ③ Grinding ④ Feed Direction ⑤ Clamp part: 4 mm ⑥ Nose Radius: 0.5 ⑦ Degree: 30°</p>	 <p>Ex) MFGN4-0.5R-30D</p>
<p>MFGN4 - 0.5R - L 50 D - R 30D</p> <p>① ② ③ ④ ⑤ ⑥</p> <p>① Refer to No. 1 ② Nose Radius: 0.5 ③ Left ④ Degree: 50° ⑤ Right ⑥ Degree > 30°</p>	 <p>Ex) MFGN4-0.5R-L50D-R30D</p>
<p>MFGN4 - 2.0 - R 020 250 - L 105 335</p> <p>① ② ③ ④ ⑤ ⑥ ⑦ ⑧</p> <p>① Refer to No. 1 ② Width of cutting edge: 2.0mm ③ Right ④ Nose Radius: 0.20 ⑤ Degree: 25.0° ⑥ Left ⑦ Nose Radius: 1.05 ⑧ Degree: 35.5°</p>	 <p>Ex) MFGN4-2.0-R020250-L105335</p>
<p>MFGN5 - 4.0R F</p> <p>① ② ③</p> <p>① Refer to No. 1 ② Radius: 4.0 ③ Front(Concave)</p>	 <p>Ex) MFGN5-4.0RF</p>
<p>MFGN5 - 4.0R B</p> <p>① ② ③</p> <p>① Refer to No. 1 ② Radius: 4.0 ③ Back(Concave)</p>	 <p>Ex) MFGN5-4.0RB</p>
<p>MFGN5 - 4.0 - R 005 - L 030</p> <p>① ② ③ ④ ⑤ ⑥</p> <p>① Refer to No. 1 ② Width of cutting edge: 4.0 mm ③ Right ④ Nose Radius: 0.05 ⑤ Left ⑥ Nose Radius : 0.30</p>	 <p>Ex) MFGN5-4.0-R005-L030</p>
<p>MFGN5 - 4.0 - 0.05 R</p> <p>① ② ③</p> <p>① Refer to No. 1 ② Width of cutting edge: 4.0 mm ③ Nose Radius: 0.05</p>	 <p>Ex) MFGN5-4.0-0.05R</p>
<p>MFG R 5 - 4.0 - 5D - R 002 - L 115</p> <p>① ② ③ ④ ⑤ ⑥ ⑦ ⑧ ⑨</p> <p>① Refer to No. 1 ② Right ③ Clamp part: 5mm ④ Width of cutting edge: 4.0mm ⑤ Lead angle: 5° ⑥ Right ⑦ Nose Radius: 0.02 ⑧ Left ⑨ Nose Radius: 1.15</p>	 <p>Ex) MFGR5-4.0-5D-R002-L115</p>
<p>MFG L 5 - 4.0 - 15D - 1.5R</p> <p>① ② ③ ④ ⑤ ⑥</p> <p>① Refer to No. 1 ② Left ③ Clamp part: 5 mm ④ Width of cutting edge: 4.0 mm ⑤ Lead angle: 15° ⑥ Right Nose Radius: 1.5</p>	 <p>Ex) MFG L 5-4.0-15D-1.5R</p>
<p>MFG R 5 - 4.10 - 25D - R012 - L000</p> <p>① ② ③ ④ ⑤ ⑥ ⑦</p> <p>① Refer to No. 1 ② Right ③ Clamp part: 5mm ④ Width of cutting edge: 4.1mm ⑤ Degree: 25° ⑥ Right Nose Radius: 1.2 ⑦ Left Nose Radius: 0.0</p>	 <p>Ex) MFG R 5-4.10-25D-R012-L000</p>



Code system

KP 27 064 - R0.425 N3

KORLOY PULLEY

ØD

W

R1

No. of flutes

Ex)

I.C

T

R

Z

Ø 15.875

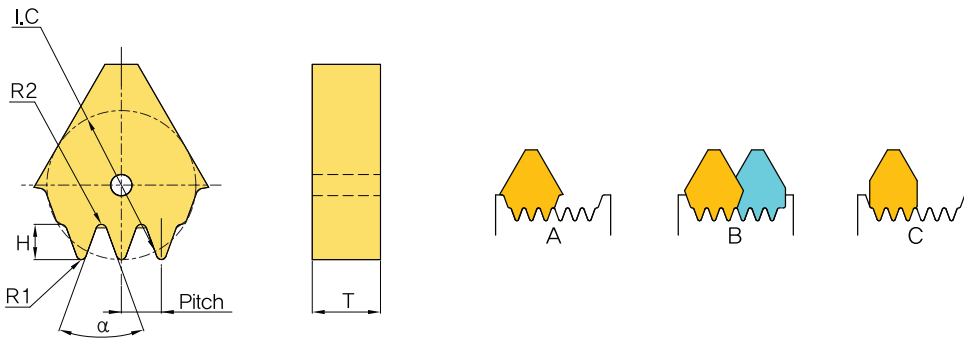
6.4

0.425

3

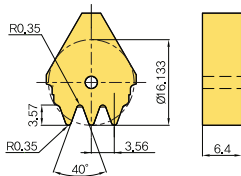
► Special types are available for quotation

Insert for machining of pulley



Specifications

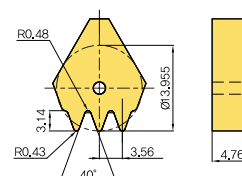
Standard designation



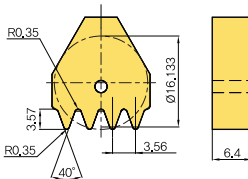
KP27064-R0.35-N3
(Former: DF356-3B)

Specifications

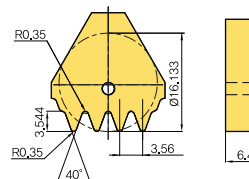
Standard designation



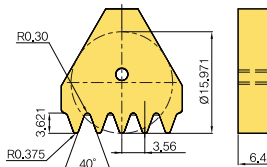
KP27064-R0.43-N3
(Former: DF356-3SR)



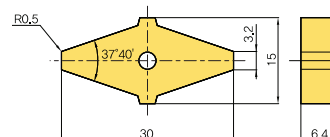
KP27064-R0.35-N4
(Former: DF356-4B)



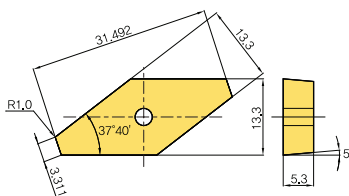
KP27064-R0.35-N4-A
(Former: DF356-4X)



KP27064-R0.375-N5
(Former: DF356-5B)



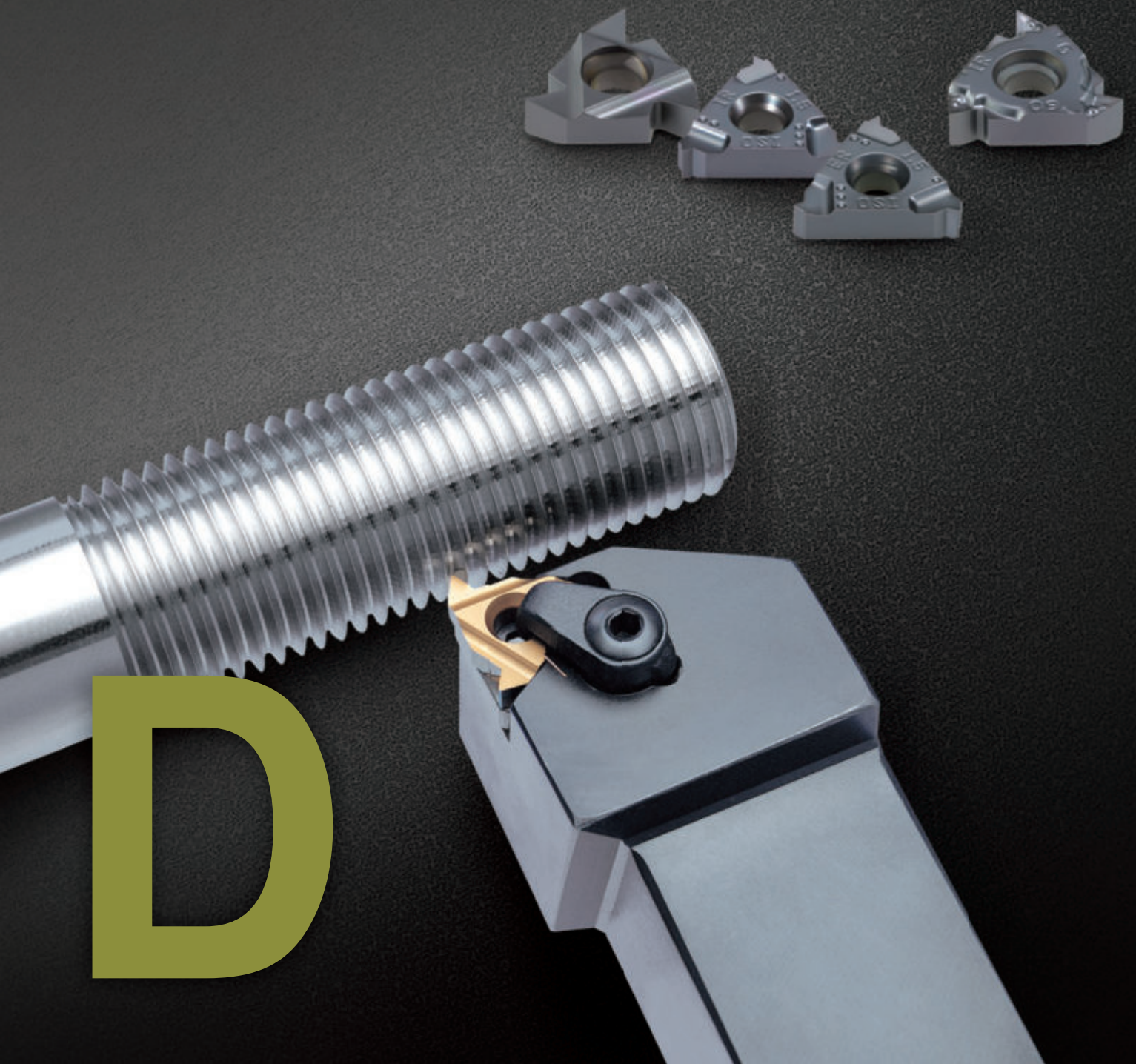
UF320



VF13M522

THREADING

Korloy threading tools are available for machining various shapes of thread at various pitches while ensuring high quality performances



D

Threading Code System

- D02** Threading Holder Code System
- D02** Threading Insert Code System

Technical Information for Threading

- D03** Technical Information for Threading
- D09** Threading Insert with Chip Breaker

Thread Inserts

- D10** Partial profile 60°
- D11** Partial profile 55°
- D12** ISO Metric
- D16** American UN
(UN, UNC, UNF, UNEF, UNS)
- D18** Whitworth (BSW, BSF, BSP, BSB)
- D22** British Standard Pipe Thread
(BSPT)
- D22** National Pipe Thread (NPT)
- D23** National Pipe Threads-Dryseal
(NPTF)
- D23** Round DIN405 (RD)

Thread Inserts

- D24** Trapez DIN103 (TR)
- D24** American ACME (ACME)
- D25** Stub ACME (STACME)
- D26** UNJ (Unified Constant Thread)
- D28** American Buttress (ABUT)
- D28** British Buttress (BBUT)
- D29** Metric Buttress (SAGE)/API
- D30** API Buttress Casing (BUT)
- D30** API Round Casing & Tubing (APIRD)
- D30** Extreme Line Casing (EL)

Thread Holders

- D31** External Holder
- D32** Internal Holder
- D33** Vertical Type Holder

Thread Milling

- D34** Technical Information for Thread Milling
- D44** Thread Milling Insert
- D49** Thread Milling Holder

D Threading Code System

Threading holder code system

E R H 10 (N) - 11 (C)

1 2 3 4 5 6 7

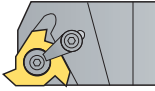
Holder type Hand of insert Name Height of shank Shim Insert size (mm) Clamping system

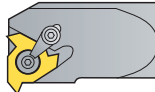
1 Holder type
E R H 10 (N) - 11 (C)
 E: For External I: For Internal

2 Hand of insert
E R H 10 (N) - 11 (C)
 R: Right handed L: Left handed

3 Name
E R H 10 (N) - 11 (C)
 H: Holder

4 Height of shank
E R H 10 (N) - 11 (C)

 - External
 8, 10, 12, 16, 20, 25, 32, 40, 50

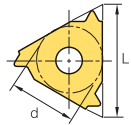
 - Internal
 10, 12, 13, 16, 20, 25, 32, 49, 50, 60

* Refer to the specification for shank diameter information

5 Shim
E R H 10 (N) - 11 (C)
 No code: Shim required
 N: No shim required

6 Insert size (mm)
E R H 10 (N) - 11 (C)

11: d = 6.35
 16: d = 9.525
 22: d = 12.7
 27: d = 15.875



7 Clamping system
E R H 10 (N) - 11 (C)
 No code: Screw on system
 C: Clamp on system

Threading insert code system

E R M 16 - 1.5 ISO

1 2 3 4 5 6

Insert type Hand of insert Chip breaker Insert size (mm) Pitch Type

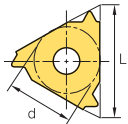
1 Insert type
E R M 16 - 1.5 ISO
 E: External thread I: Internal thread



2 Hand of insert
E R M 16 - 1.5 ISO
 R: Right handed L: Left handed

3 Chip breaker
E R M 16 - 1.5 ISO
 M: With chip breaker

4 Insert size (mm)
E R M 16 - 1.5 ISO

11: d = 6.35
 16: d = 9.525
 22: d = 12.7
 27: d = 15.875



Insert shape  <ER/IR>  <ERM/IRM>

5 Pitch
E R M 16 - 1.5 ISO

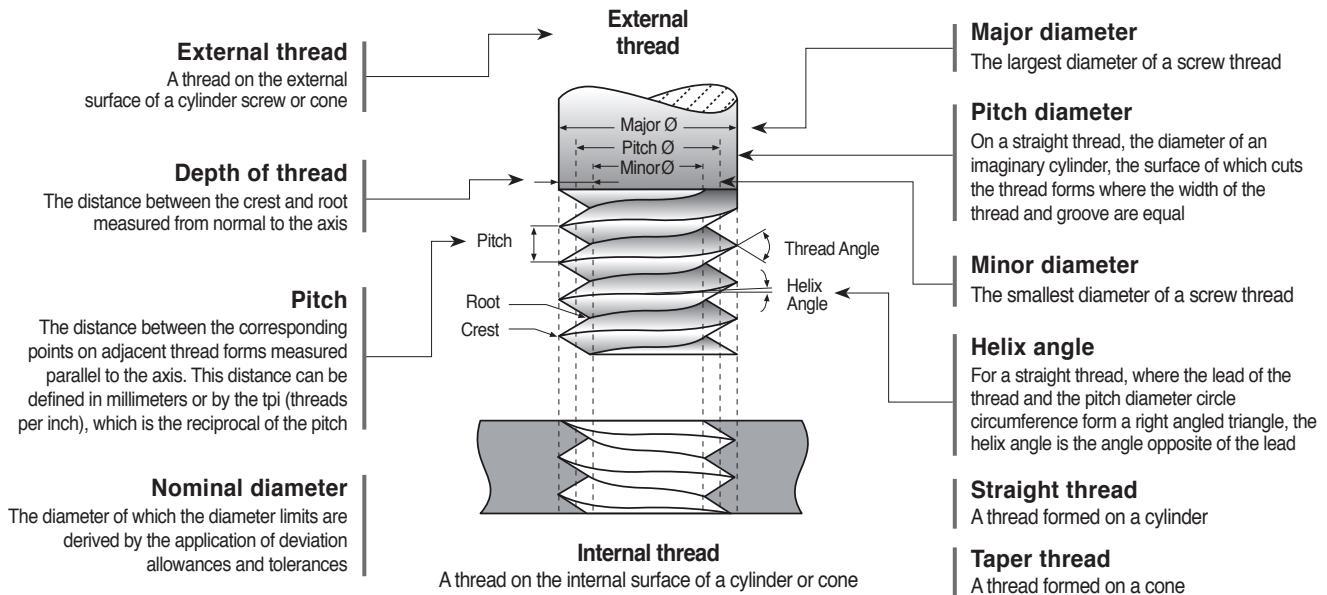
Full profile		Partial profile	
mm	tpi	mm	tpi
0.35-6.0	72-3	A	0.5-1.5 48-16
		AG	0.5-3.0 48-8
		G	1.75-3.0 14-8
		N	3.5-5.0 7-5
		Q	5.5-6.0 4.5-4

6 Type
E R M 16 - 1.5 ISO

Partial profile 60°
 Partial Profile 55°
 ISO Metric (Full Profile)
 American UN (Full Profile) UN, UNC, UNF, UNEF
 Whitworth (Full Profile) BSW, BSF, BSP
 British Standard Pipe thread (Full Profile) BSPT
 National Pipe Thread (Full Profile) NPT
 National Pipe Threads-Dryseal (Full Profile) NPTF
 Round DIN 405
 Trapez DIN 103
 American ACME
 Stub ACME
 UNJ
 American Buttress
 British Buttress
 Metric Buttress-Sagengewinde
 API
 API Buttress Casing
 API Round Casing & Tubing
 EL-Extreme Line Casing



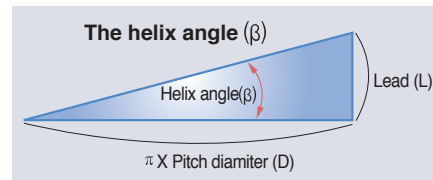
Special features



A thread which, when viewed axially, winds in a counter clockwise and receding direction. All left handed threads are designated LH



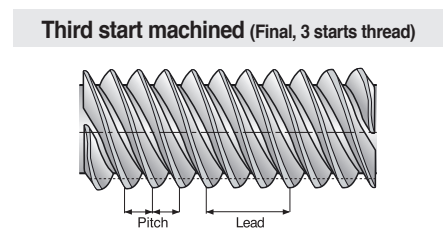
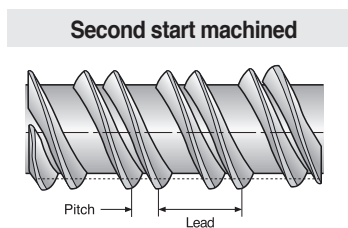
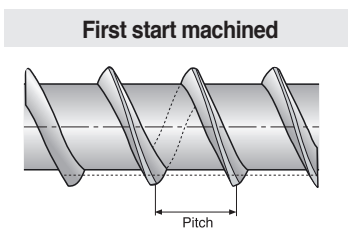
A thread which, when viewed axially, winds in a clockwise and receding direction. Threads are always right handed unless they are specified



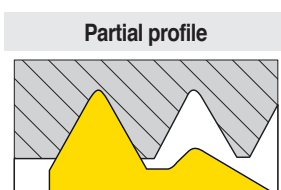
For a straight thread, where the lead of the thread and the pitch diameter circle circumference form a right angled triangle, the helix angle is the angle opposite of the lead

Machining a multi-start thread

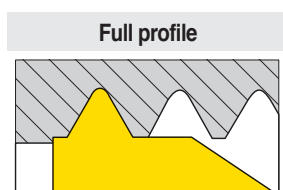
- A thread in which the lead is an integral multiple, greater than one, of the pitch. A multi-start thread permits a more rapid advance without a coarser (larger) thread form



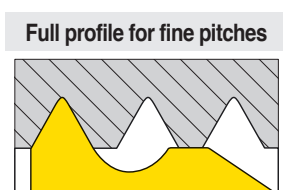
Insert profile style



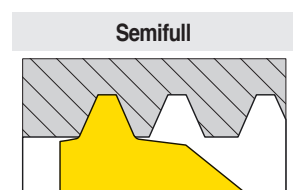
The V partial profile insert cuts without topping the outer diameter of the thread. The same insert can be used for a range of different thread pitches which have a common thread angle



The full profile insert will form a complete thread profile including the crest. For every thread pitch and standard, a separate insert is required



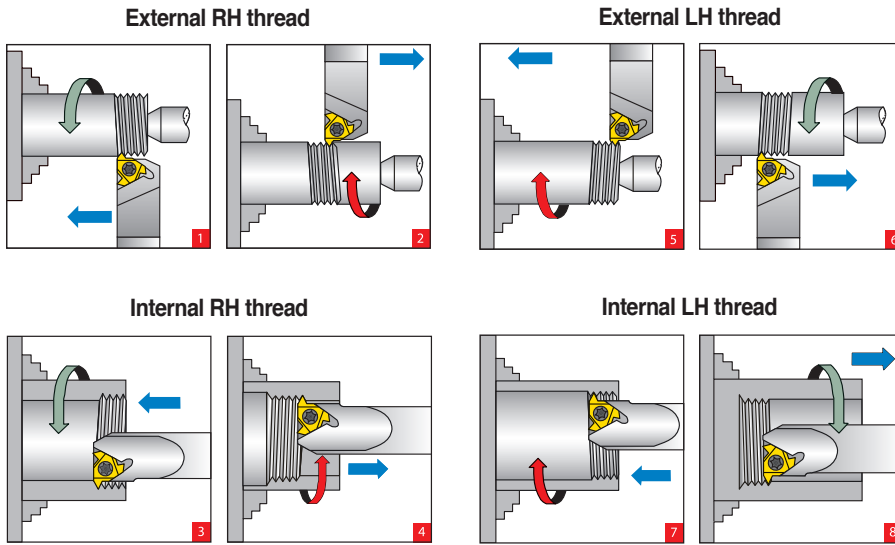
The full profile for Fine Pitches will form a complete thread. The topping of the outer diameter is generated by second tooth



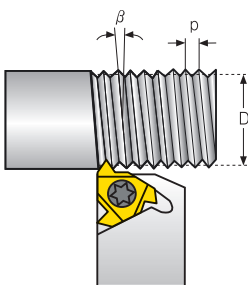
The Semi profile insert will form a complete thread including crest radius but without topping the outer diameter. Mainly used for trapezoidal profiles

Thread turning method

Thread	Inserts & Tool holder	Rotation	Feed direction	Helix method	Drawing no.
Right Hand Externa	EX RH	Counter clockwise	Towards chuck	Regular	1
	EX LH	Clockwise	From chuck	Reversed	2
Right Hand Internal	IN RH	Counter clockwise	Towards chuck	Regular	3
	IN LH	Clockwise	From chuck	Reversed	4
Left Hand External	EX LH	Clockwise	Towards chuck	Regular	5
	EX RH	Counter clockwise	From chuck	Reversed	6
Left Hand Internal	IN LH	Clockwise	Towards chuck	Regular	7
	IN RH	Counter clockwise	From chuck	Reversed	8



Calculating the helix angle (β)

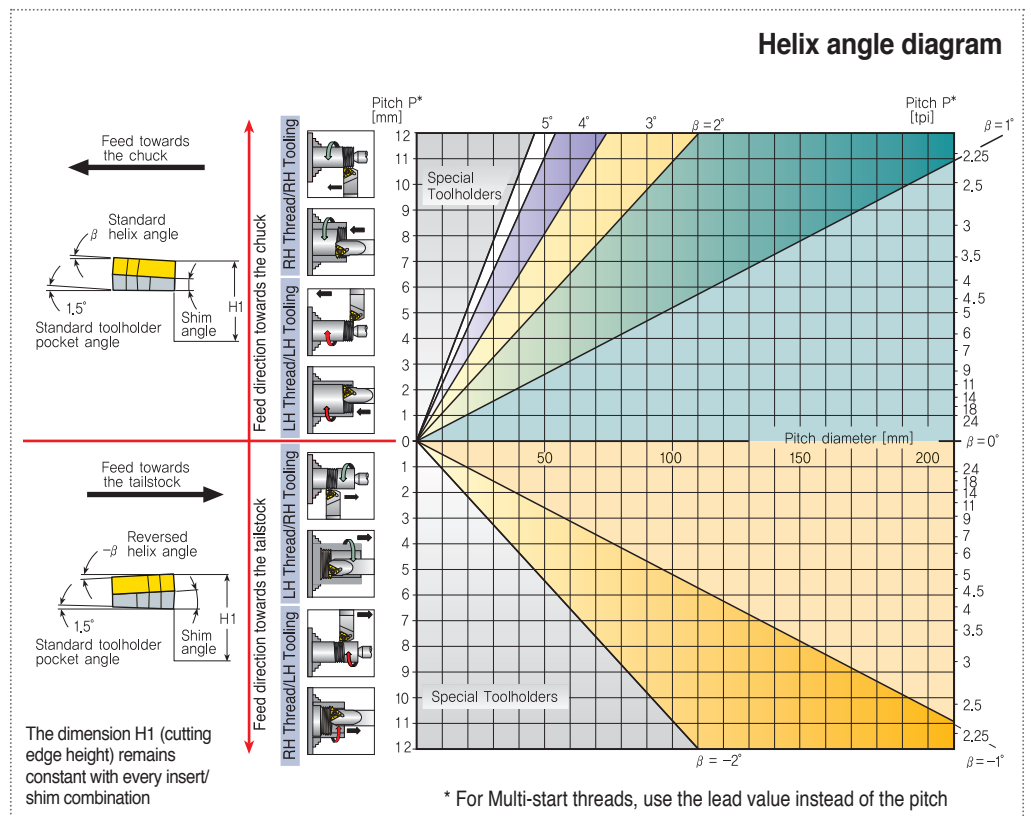


- The helix angle is calculated by the following formula:

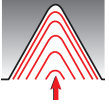
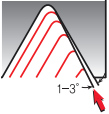

$$\beta = \tan^{-1} \frac{P \times N}{\pi \times D}$$

- β: Helix angle (°)
- P: Pitch (mm)
- N: No. of starts
- D: Pitch diameter (mm)
- Lead = P x N



- The helix angle can also be found from the diagram below



Thread infeed method

Infeed	Application
 <p>Radial infeed</p>	<ul style="list-style-type: none"> When the pitch is smaller than 16 tpi For material with short chips For work with hardened material <p>Radial infeed is the simplest and quickest method. The feed is perpendicular to the turning axis, and both flanks of the insert perform the cutting operation. Radial infeed is recommended in 3 cases.</p>
 <p>Flank infeed (modified)</p>	<ul style="list-style-type: none"> When the thread pitch is greater than 16 tpi. Using the radial method, the effective cutting edge length is too large, resulting in chatter. For TRAPEZ and ACME. The radial method results in three cutting edges, making chip flow very difficult. <p>Flank infeed is recommended in the following cases.</p>
 <p>Alternate flank infeed</p>	<ul style="list-style-type: none"> This method divides the load equally on both flanks, resulting in equal wear along the cutting edges. Alternate flank infeed requires more complicated programming, and is not available on all lathes. <p>Use of the alternate flank method is recommended especially in large pitches and for materials with long chips.</p>

Shim

Standard shim	ATE (External) ATI (Through)		Helix angle 1.5°	Insert size	d	9.525		12.7		15.875	
					L	16		22		27	
				Holder	ER(L)H	IR(L)H	ER(L)H	IR(L)H	ER(L)H	IR(L)H	
				Ordering code	ATE16	ATI16	ATE22	ATI22	ATE27	ATI27	
 		<p>※ Standard shim has lead angle 1.5°</p>									

Application grade

Grade	Features		Available insert type
PC5300	Universal grade	<ul style="list-style-type: none"> For chip breaker type only Stable machining on a wide application due to fine-grained carbide substrate with balanced heat resistance and toughness Excellent wear resistance and oxidation resistance due to TiN coating film. Outstanding performance on high speed machining 	ERM/IRM (Insert with Chip breaker)
PC3030T	Specialized grade for threading inserts	<ul style="list-style-type: none"> A tough sub-micron substrate with TiAlN coating provides good fracture toughness and excellent wear resistance Outstanding performance on STS and hard to cut materials 	ER/IR (Ground insert)
PC9070T	Specialized grade for threading inserts	<ul style="list-style-type: none"> Strong wear resistance in stainless machining thanks to multilayer PVD coatings 	E/IR (Ground insert)

Application range

Workpiece		Application Range
P	Carbon steel, Alloy steel, Cast Steel	PC5300, PC3030T
M	Stainless steel	PC5300, PC3030T, PC9070T
K	Cast Steel	PC5300, PC3030T
N	Aluminum, Copper	PC5300, PC3030T

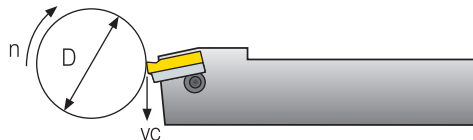
D Technical Information for Threading

Recommended cutting speed as per workpiece (vc)

Workpiece			Hardness brinell (HB)	vc (m/min)		
				PC3030T	PC9070T	PC5300
P	Carbon steel	Low carbon (C=0.1-0.25 %)	125	115~190		110~190
		Medium carbon (C=0.25-0.55 %)	150	100~175		100~165
		High carbon (C=0.55-0.85 %)	170	90~155		90~155
	Low alloy steel	Non-hardened	180	100~180		100~180
		Hardened	275	75~140		75~140
		Hardened	350	70~135		70~135
	High alloy steel	Annealed	200	80~120		80~120
		Hardened	325	50~100		50~100
Cast steel	Low alloy	200	70~130		70~130	
	High alloy	225	60~120		60~120	
M	Stainless steel ferritic	Non-hardened	200	70~130	70~150	70~130
		Hardened	330	50~95	60~125	50~95
	Stainless steel austenitic	Austenitic	180	80~120	90~160	80~120
		Super austenitic	200	30~100	40~120	30~100
	Stainless steel cast ferritic	Non-hardened	200	90~120	90~150	90~120
		Hardened	330	65~110	65~120	65~110
	Stainless steel cast austenitic	Austenitic	200	85~110	85~120	85~110
		Hardened	330	60~100	60~110	60~100
	High temperature alloy	Annealed (Iron based)	200	45~60		45~60
		Aged (Iron based)	280	30~50		30~50
		Annealed (Nickel or Cobalt based)	250	20~30		20~30
		Aged (Nickel or Cobalt based)	350	15~25		15~25
Titanium alloy	99.5% pure Titanium	400Rm	140~170		140~170	
	Titanium alloy	1050Rm	50~70		50~70	
K	Extra hard steel	Hardened & tempered	55HRC	45~60		45~60
	Malleable cast iron	Ferritic (short chips)	130	70~120		70~120
		Pearlitic (long chips)	230	70~120		70~120
	Gray cast iron	Low tensile strength	180	70~130		70~130
		High tensile strength	260	60~100		60~100
	Nodular SG iron	Ferritic	160	125~160		125~160
Pearlitic		260	90~120		90~120	
N	Aluminum alloy wrought	Non-aging	60	100~250		100~250
		Aged	100	80~180		80~180
	Aluminum alloy	Cast	75	200~400		200~400
		Cast & aged	90	200~280		200~280
		Cast Si 13-22%	130	60~150		60~180
	Copper and copper alloy	Brass	90	80~120		80~210
Bronze and non-leaded copper		100	80~120		80~210	

Calculation of n [RPM]

$$n = \frac{vc \times 1000}{\pi \times D} \quad vc = \frac{\pi \times D \times n}{1000}$$



n: Revolution Per Minute [min⁻¹]
vc: Cutting Speed [m/min]
D: Workpiece Diameter [mm]

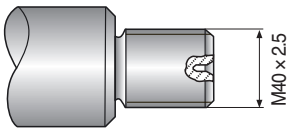
Number of passes

Pitch	mm	0.50	0.75	1.00	1.25	1.50	1.75	2.00	2.50	3.00	3.50	4.00	4.50	5.00	5.50	6.00	8.00
	tpi	48	32	24	20	16	14	12	10	8	7	6	5.5	5	4.5	4	3
No. of passes		4~6	4~7	4~8	5~9	6~10	7~12	7~12	8~14	9~16	10~18	11~18	11~19	12~20	12~20	12~20	15~24

* One cutting depth is calculated by total cutting depth divided into machining times
ex) ER16-1.5ISO, hmin 0.92: If 10 times machining, one cutting depth is 0.092 (0.92/10)



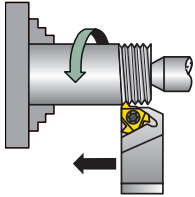
Step by step thread turning



Application

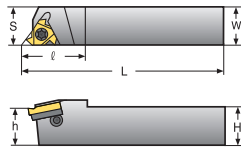
- Thread: External right hand ISO metric M40x2.5
- Material: 4140 (25 HRC)

1 Choose the thread turning method



Feed direction towards the chuck was chosen
Therefore an external right hand insert and an external right hand holder will be used

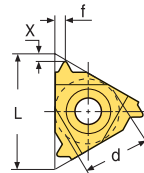
3 Choose the tool holder



Chosen tool holder: ERH 25-16

Insert size	Ordering code	Dimensions (mm)				
		d	H=h	W	S	L
9.525	ERH25-16	25	25	25	153.6	30

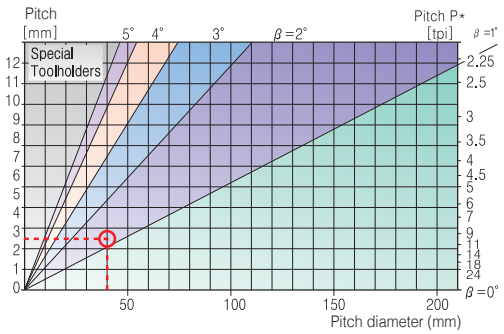
2 Choose the insert size



Chosen insert: ER16-2.5 ISO

Insert size	Pitch	Ordering code	Shim		Tool holder
			d	mm	
9.525	2.5	ER16-2.5ISO	ATE16	ERH□□-16	

4 Determine the helix angle



From the table, using a pitch of 2.5 mm (10 tpi) and a workpiece diameter of 40 mm (1.57"), we find the helix angle to be 1.5°

5 Choose the correct shim

Resultant Helix angle		1.5°
Insert size	d	9.525
	L	16
Ordering code		ATE16

6 Choose the carbide grade and cutting speed

Workpiece	HB	vc (m/min)	
		PC3030T	
P Low alloy steel (alloying elements ≤ 5%)	Non-hardened	180	85~145
	Hardened	275	75~140
	Hardened	350	70~135

- Carbide grade chosen: PC3030T
- Cutting speed: 140 m/min

7 Determine the number of passes

Pitch	mm	1.50	1.75	2.00	2.50	3.00	3.50	4.00
	tpi	16	14	12	10	8	7	6
No. of passes		6~10	7~12	7~12	8~14	9~16	10~18	11~18

- Carbide grade chosen: PC3030T
- Cutting speed: 140 m/min

8 Summary

Thread type	ISO M40 x 2.5 External right hand
1. Feed direction	Towards the chuck
2. Insert and grade	ER16-2.5ISO, PC3030T
3. Tool holder	ERH25-16
4. Helix angle	1.5°
5. Shim	ATE16
6. Cutting speed	140 m/min
7. Number of passes	10

D Technical Information for Threading

➤ Cutting condition depending on

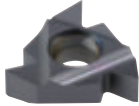








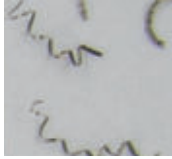
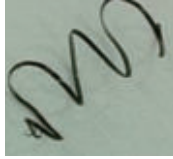
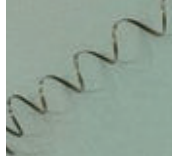
Workpiece	Material type		Coolant	Coolant type			
	Material dimension			Holders	Holder cross section area		
	Diameter and length chipflow character				Holder overhang		
	Material hardness				Through coolant option		
Thread application	External or internal		Shank type: Carbide, alloy	Shank type: Carbide, alloy			
	Profile shape				Insert	Carbide implant grade	
	Surface finish					Profile shape: Pitch and depth	
Machine	Machine stability		Insert	Nose radius			
	Max. RPM			Chip breaker style			
	Clamping system stability						

➤ Trouble shooting


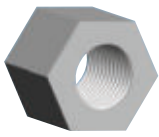
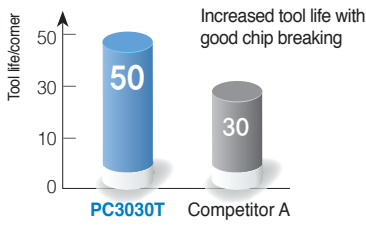
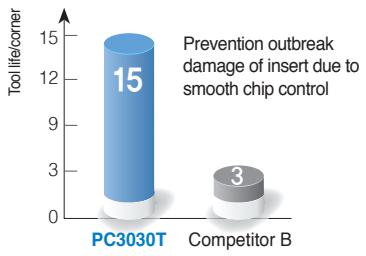
Problem	Possible cause	Solution
Increased flank wear	Cutting speed too high ➤ Depth of cut too low/too many passes ➤ Unsuitable carbide grade ➤ Insufficient cooling ➤	Reduce cutting speed/use coated insert Increase the depth of cut per pass Use a coated carbide grade Increase coolant flow rate
Uneven cutting edge wear	Incorrect helix angle ➤ Wrong infeed method ➤	Choose the correct shim Use the alternating flank infeed method
Extreme plastic deformation	Depth of cut too large ➤ Insufficient cooling ➤ Cutting speed too high ➤ Unsuitable carbide grade ➤ Nose radius too small ➤	Decrease depth of cut/ increase number of passes Increase coolant flow rate Reduce cutting speed Use a tougher carbide Use an insert with a larger radius, if possible
Cutting edge breakage	Depth of cut too large ➤ Extreme plastic deformation ➤ Insufficient cooling ➤ Unsuitable carbide grade ➤ Instability ➤	Decrease depth of cut/ increase number of passes. Use a tougher carbide Increase flow rate and/ or correct flow direction Use a tougher carbide Check stability of the system
Built-up edge	Incorrect cutting speed ➤ Unsuitable carbide grade ➤	Change the cutting speed Use a coated carbide
Thread profile is too shallow	The tool is not at the workpiece axis height ➤ Insert is not machining the thread crest ➤ Worn insert ➤	Change tool height Measure the workpiece diameter Change the cutting edge sooner
Poor surface quality	Too low cutting speed ➤ Wrong shim ➤ Flank infeed method is not appropriate ➤	Increase cutting speed Choose correct shim Use the alternate flank or radial infeed method

Threading insert with chip breaker

- Features**
- Economical insert
 - Good toughness and high accuracy as ground type inserts
 - Exclusive insert design improves chip control
 - New grade for general application of various kinds of workpieces

Type	Ground insert		Insert with a chip breaker			
C/B Code	None		None		U	
Designation	ER16-1.5ISO		ERM16-1.5ISO		ERM16-1.5ISO-U	
Machining	External	Internal	External	Internal	External	Internal
Insert Shape						
Chip Shape						
Class	P, M, K, N, S		P, M, K		P, M, K	
Application	G-Class		M-Class		M-Class	
Features	<ul style="list-style-type: none"> • Groove-shaped chip breaker with superior chip evacuation lowers cutting load • Enables high precision machining • Applicable for machining of various shapes of threads • Applicable for machining of various workpieces 		<ul style="list-style-type: none"> • Unique 3 dimensional chip breaker improves machinability with good chip control • Excellent cutting edge treatment technology ensures high precision sharp cutting edge 		<ul style="list-style-type: none"> • Groove-shaped chip breaker with superior chip evacuation lowers cutting load • Reduces machining pass by 10~30% • Excellent cutting edge treatment achieves high precision sharp cutting edge 	

Application examples

KORLOY		ERM16-1.5ISO [PC3030T]	IRM16-2.0ISO [PC3030T]
Competitor tools		ER16-1.5ISO [A-Maker]	IR16-2.0ISO [B-Maker]
Workpiece	Material	SCM440	STS304
	Figure		
Cutting condition	Cutting speed (m/min)	63	120
	Pass	8	9
	Machining	Radial infeed	Radial infeed
	Pitch	1.5	2.0
Coolant		Wet	Wet
Result		 <p>Increased tool life with good chip breaking</p>	 <p>Prevention outbreak damage of insert due to smooth chip control</p>

Partial profile 60°

Type	Designation (Right)	PC3030T	PC9070T	Designation (Left)	PC3030T	PC9070T	Pitch		Dimensions (mm)					Picture
							(mm)	(tpi)	d	L	r	x	f	
External	ER 11-A60	●	●	EL 11-A60	●		0.5~1.5	48~16	6.35	11	0.05	0.8	0.9	
	16-A60	●	●	16-A60	●		0.5~1.5	48~16	9.525	16	0.05	0.8	0.9	
	16-G60	●		16-G60	●		1.75~3.0	14~8	9.525	16	0.27	1.2	1.7	
	16-AG60	●	●	16-AG60	●		0.5~3.0	48~8	9.525	16	0.08	1.2	1.7	
	22-N60	●	●	22-N60	●		3.5~5.0	7~5	12.7	22	0.53	1.7	2.5	
	27-Q60	●	●	27-Q60	●		5.5~6.0	4.5~4	15.875	27	0.64	2.1	3.1	
Internal	IR 11-A60	●	●	IL 11-A60	●	●	0.5~1.5	48~16	6.35	11	0.05	0.8	0.9	
	16-A60	●		16-A60	●		0.5~1.5	48~16	9.525	16	0.05	0.8	0.9	
	16-G60	●		16-G60	●		1.75~3.0	14~8	9.525	16	0.16	1.2	1.7	
	16-AG60	●	●	16-AG60	●		0.5~3.0	48~8	9.525	16	0.05	1.2	1.7	
	22-N60	●	●	22-N60	●		3.5~5.0	7~5	12.7	22	0.30	1.7	2.5	
	27-Q60	●	●	27-Q60			5.5~6.0	4.5~4	15.875	27	0.30	1.8	2.7	

➔ Applicable holders D31, D32

●: Stock item

Partial profile 60° (M chip breaker)

Type	Designation (Right)	PC3030T	PC5300	Designation (Left)	PC3030T	Pitch		Dimensions (mm)					Picture		
						(mm)	(tpi)	d	L	r	x	f			
External	ERM 16-A60	●					0.5~1.5	48~16	9.525	16	0.08	0.8	0.9		
	16-G60	●					1.75~3.0	14~8	9.525	16	0.27	1.2	1.7		
	16-AG60	●						0.5~3.0	48~8	9.525	16	0.08	1.2		1.7
	22-N60	●						3.5~5.0	7~5	12.7	22	0.53	1.7		2.5
Internal	IRM 11-A60	●					0.5~1.5	48~16	6.35	11	0.08	0.8	0.9		
	16-A60	●					0.5~1.5	48~16	9.525	16	0.08	0.8	0.9		
	16-G60	●						1.75~3.0	14~8	9.525	16	0.12	1.2		1.7
	16-AG60	●						0.5~3.0	48~8	9.525	16	0.08	1.2		1.7
	22-N60	●						3.5~5.0	7~5	12.7	22	0.30	1.7		2.5

➔ Applicable holders D31, D32

●: Stock item

Partial profile 60° (U chip breaker)

Type	Designation (Right)	PC3030T	PC5300	Designation (Left)	PC3030T	Pitch		Dimensions (mm)					Picture	
						(mm)	(tpi)	d	L	r	x	f		
External	ERM 16-AG60-U						0.5~3.0	48~8	9.525	16	0.08	1.2	1.7	
Internal	IRM 16-AG60-U						0.5~3.0	48~8	9.525	16	0.08	1.2	1.7	

➔ Applicable holders D31, D32

●: Stock item



Partial profile 55°

Type	Designation (Right)	PC3030T	PC9070T	Designation (Left)	PC3030T	PC9070T	Pitch		Dimensions (mm)					Picture
							(mm)	(tpi)	d	L	r	x	f	
External	ER 11-A55	●		EL 11-A55			0.5~1.5	48~16	6.35	11	0.05	0.8	0.9	
	16-A55	●		16-A55	●		0.5~1.5	48~16	9.525	16	0.05	0.8	0.9	
	16-G55	●		16-G55			1.75~3.0	14~8	9.525	16	0.21	1.2	1.7	
	16-AG55	●		16-AG55	●		0.5~3.0	48~8	9.525	16	0.07	1.2	1.7	
	22-N55	●		22-N55			3.5~5.0	7~5	12.7	22	0.43	1.7	2.5	
	27-Q55			27-Q55			5.5~6.0	4.5~4	15.875	27	0.60	2.0	2.9	
Internal	IR 11-A55	●		IL 11-A55	●		0.5~1.5	48~16	6.35	11	0.05	0.8	0.9	
	16-A55	●		16-A55			0.5~1.5	48~16	9.525	16	0.05	0.8	0.9	
	16-G55	●		16-G55			1.75~3.0	14~8	9.525	16	0.21	1.2	1.7	
	16-AG55	●		16-AG55	●		0.5~3.0	48~8	9.525	16	0.07	1.2	1.7	
	22-N55	●		22-N55			3.5~5.0	7~5	12.7	22	0.43	1.7	2.5	
	27-Q55			27-Q55			5.5~6.0	4.5~4	15.875	27	0.60	2.0	2.9	

➡ Applicable holders D31, D32

● : Stock item

Partial profile 55° (M chip breaker)

Type	Designation (Right)	PC3030T	PC5300	Designation (Left)	PC3030T	Pitch		Dimensions (mm)					Picture
						(mm)	(tpi)	d	L	r	x	f	
External	ERM 16-A55	●				0.5~1.5	48~16	9.525	16	0.08	0.8	0.9	
	16-G55	●				1.75~3.0	14~8	9.525	16	0.21	1.2	1.7	
	16-AG55	●				0.5~3.0	48~8	9.525	16	0.07	1.2	1.7	
	22-N55	●				3.5~5.0	7~5	12.7	22	0.43	1.7	2.5	
Internal	IRM 11-A55	●				0.5~1.5	48~16	6.35	11	0.08	0.8	0.9	
	16-A55	●				0.5~1.5	48~16	9.525	16	0.05	0.8	0.9	
	16-G55	●				1.75~3.0	14~8	9.525	16	0.08	1.2	1.7	
	16-AG55	●				0.5~3.0	48~8	9.525	16	0.08	1.2	1.7	
	22-N55	●				3.5~5.0	7~5	12.7	22	0.43	1.7	2.5	

➡ Applicable holders D31, D32

● : Stock item

Partial profile 55° (U chip breaker)

Type	Designation (Right)	PC3030T	PC5300	Designation (Left)	PC3030T	Pitch		Dimensions (mm)					Picture
						(mm)	(tpi)	d	L	r	x	f	
External	ERM 16-AG55-U					0.5~3.0	48~8	9.525	16	0.07	1.2	1.7	
Internal	IRM 16-AG55-U					0.5~3.0	48~8	9.525	16	0.08	1.2	1.7	

➡ Applicable holders D31, D32

● : Stock item

ISO Metric

Type	Designation (Right)	PC3030T	PC9070T	Designation (Left)	PC3030T	PC9070T	Pitch (mm)	Dimensions (mm)					Picture
								d	L	hmin	X	f	
External	ER 11-0.35ISO	●		EL 11-0.35ISO			0.35	6.35	11	0.21	0.8	0.4	
	11-0.4ISO	●		11-0.4ISO			0.4	6.35	11	0.25	0.7	0.4	
	11-0.45ISO	●		11-0.45ISO			0.45	6.35	11	0.28	0.7	0.4	
	11-0.5ISO	●		11-0.5ISO			0.5	6.35	11	0.31	0.6	0.4	
	11-0.6ISO	●		11-0.6ISO			0.6	6.35	11	0.37	0.6	0.6	
	11-0.7ISO	●		11-0.7ISO			0.7	6.35	11	0.43	0.6	0.6	
	11-0.75ISO			11-0.75ISO			0.75	6.35	11	0.46	0.6	0.6	
	11-0.8ISO	●		11-0.8ISO			0.8	6.35	11	0.49	0.6	0.6	
	11-1.0ISO	●		11-1.0ISO			1.0	6.35	11	0.61	0.7	0.7	
	11-1.25ISO	●	●	11-1.25ISO			1.25	6.35	11	0.77	0.8	0.9	
	11-1.5ISO	●		11-1.5ISO	●		1.5	6.35	11	0.92	0.8	1.0	
	11-1.75ISO	●		11-1.75ISO			1.75	6.35	11	1.07	0.8	1.1	
	16-0.35ISO			16-0.35ISO			0.35	9.525	16	0.21	0.8	0.4	
	16-0.4ISO			16-0.4ISO			0.4	9.525	16	0.25	0.7	0.4	
	16-0.45ISO	●		16-0.45ISO			0.45	9.525	16	0.28	0.7	0.4	
	16-0.5ISO	●		16-0.5ISO	●		0.5	9.525	16	0.31	0.6	0.4	
	16-0.6ISO	●		16-0.6ISO			0.6	9.525	16	0.37	0.6	0.6	
	16-0.7ISO	●		16-0.7ISO			0.7	9.525	16	0.43	0.6	0.6	
	16-0.75ISO	●		16-0.75ISO			0.75	9.525	16	0.46	0.6	0.6	
	16-0.8ISO	●	●	16-0.8ISO			0.8	9.525	16	0.49	0.6	0.6	
	16-1.0ISO	●	●	16-1.0ISO	●		1.0	9.525	16	0.61	0.7	0.7	
	16-1.25ISO	●	●	16-1.25ISO	●		1.25	9.525	16	0.77	0.8	0.9	
	16-1.5ISO	●	●	16-1.5ISO	●		1.5	9.525	16	0.92	0.8	1.0	
	16-1.75ISO	●	●	16-1.75ISO			1.75	9.525	16	1.07	0.9	1.2	
	16-2.0ISO	●	●	16-2.0ISO	●		2.0	9.525	16	1.23	1.0	1.3	
	16-2.5ISO	●	●	16-2.5ISO			2.5	9.525	16	1.53	1.1	1.5	
	16-3.0ISO	●	●	16-3.0ISO	●		3.0	9.525	16	1.84	1.2	1.6	
	22-3.5ISO	●	●	22-3.5ISO			3.5	12.7	22	2.15	1.6	2.3	
	22-4.0ISO	●	●	22-4.0ISO	●		4.0	12.7	22	2.45	1.6	2.3	
	22-4.5ISO	●	●	22-4.5ISO			4.5	12.7	22	2.78	1.7	2.4	
	22-5.0ISO	●	●	22-5.0ISO	●		5.0	12.7	22	3.07	1.7	2.5	
	27-5.5ISO			27-5.5ISO			5.5	15.875	27	3.37	1.9	2.7	
	27-6.0ISO	●	●	27-6.0ISO			6.0	15.875	27	3.68	2.0	2.9	

➔ Applicable holders D31

●: Stock item

ISO Metric (M chip breaker)

Type	Designation (Right)	PC3030T	PC5300	Designation (Left)	PC3030T	Pitch	Dimensions (mm)					Picture
						(mm)	d	L	hmin	X	f	
External	ERM 16-1.0ISO	●				1.0	9.525	16	0.61	0.7	0.7	
	16-1.25ISO					1.25	9.525	16	0.77	0.8	0.9	
	16-1.5ISO	●				1.5	9.525	16	0.93	0.8	1.0	
	16-1.75ISO	●				1.75	9.525	16	1.09	0.9	1.2	
	16-2.0ISO	●				2.0	9.525	16	1.25	1.0	1.3	
	16-2.5ISO	●				2.5	9.525	16	1.55	1.1	1.5	
	16-3.0ISO	●				3.0	9.525	16	1.87	1.2	1.6	

➡ Applicable holders D31

● : Stock item

ISO Metric (U chip breaker)

Type	Designation (Right)	PC3030T	PC5300	Designation (Left)	PC3030T	Pitch	Dimensions (mm)					Picture
						(mm)	d	L	hmin	X	f	
External	ERM 16-1.5ISO-U					1.5	9.525	16	0.93	0.8	1.0	
	16-2.0ISO-U					2.0	9.525	16	1.25	1.0	1.3	

➡ Applicable holders D31

● : Stock item

ISO Metric

Type	Designation (Right)	PC3030T	PC9070T	Designation (Left)	PC3030T	PC9070T	Pitch	Dimensions (mm)					Picture
							(mm)	d	L	hmin	X	f	
Internal	IR 11-0.35ISO	●		IL 11-0.35ISO			0.35	6.35	11	0.20	0.8	0.3	
	11-0.4ISO	●		11-0.4ISO			0.4	6.35	11	0.23	0.8	0.4	
	11-0.45ISO	●		11-0.45ISO			0.45	6.35	11	0.26	0.8	0.4	
	11-0.5ISO	●		11-0.5ISO	●		0.5	6.35	11	0.29	0.6	0.4	
	11-0.6ISO	●		11-0.6ISO			0.6	6.35	11	0.35	0.6	0.6	
	11-0.7ISO	●		11-0.7ISO			0.7	6.35	11	0.40	0.6	0.6	
	11-0.75ISO	●		11-0.75ISO	●		0.75	6.35	11	0.43	0.6	0.6	
	11-0.8ISO			11-0.8ISO			0.8	6.35	11	0.46	0.6	0.6	
	11-1.0ISO	●	●	11-1.0ISO			1.0	6.35	11	0.58	0.6	0.7	
	11-1.25ISO	●	●	11-1.25ISO	●		1.25	6.35	11	0.72	0.8	0.9	
	11-1.5ISO	●	●	11-1.5ISO	●	●	1.5	6.35	11	0.87	0.8	1.0	
	11-1.75ISO		●	11-1.75ISO			1.75	6.35	11	1.01	0.9	1.1	
	11-2.0ISO	●	●	11-2.0ISO	●		2.0	6.35	11	1.15	0.9	1.1	
	11-2.5ISO	●		11-2.5ISO	●		2.5	6.35	11	1.44	0.8	1.1	
	16-0.35ISO	●		16-0.35ISO			0.35	9.525	16	0.20	0.8	0.3	
	16-0.4ISO	●		16-0.4ISO			0.4	9.525	16	0.23	0.8	0.4	
	16-0.45ISO	●		16-0.45ISO			0.45	9.525	16	0.26	0.8	0.4	
	16-0.5ISO	●		16-0.5ISO			0.5	9.525	16	0.29	0.6	0.4	
	16-0.6ISO			16-0.6ISO			0.6	9.525	16	0.35	0.6	0.6	
	16-0.7ISO			16-0.7ISO			0.7	9.525	16	0.40	0.6	0.6	
	16-0.75ISO	●		16-0.75ISO			0.75	9.525	16	0.43	0.6	0.6	
	16-0.8ISO	●		16-0.8ISO			0.8	9.525	16	0.46	0.6	0.6	
	16-1.0ISO	●	●	16-1.0ISO			1.0	9.525	16	0.58	0.6	0.7	
	16-1.25ISO	●	●	16-1.25ISO			1.25	9.525	16	0.72	0.8	0.9	
	16-1.5ISO	●	●	16-1.5ISO	●		1.5	9.525	16	0.87	0.8	1.0	
	16-1.75ISO	●	●	16-1.75ISO			1.75	9.525	16	1.01	0.9	1.2	
	16-2.0ISO	●	●	16-2.0ISO	●		2.0	9.525	16	1.15	1.0	1.3	
	16-2.5ISO	●	●	16-2.5ISO	●		2.5	9.525	16	1.44	1.1	1.5	
	16-3.0ISO	●	●	16-3.0ISO	●		3.0	9.525	16	1.73	1.1	1.5	
	22-3.5ISO	●	●	22-3.5ISO			3.5	12.7	22	2.02	1.6	2.3	
	22-4.0ISO	●	●	22-4.0ISO	●		4.0	12.7	22	2.31	1.6	2.3	
	22-4.5ISO	●	●	22-4.5ISO			4.5	12.7	22	2.60	1.6	2.4	
	22-5.0ISO	●	●	22-5.0ISO			5.0	12.7	22	2.89	1.6	2.3	
	27-5.5ISO	●		27-5.5ISO			5.5	15.875	27	3.17	1.6	2.3	
	27-6.0ISO	●		27-6.0ISO			6.0	15.875	27	3.46	1.8	2.5	

➔ Applicable holders D32

●: Stock item

ISO Metric (M chip breaker)

Type	Designation (Right)	PC3030T	PC5300	Designation (Left)	PC3030T	Pitch	Dimensions (mm)					Picture
						(mm)	d	L	hmin	X	f	
Internal	IRM 11-1.5ISO	●				1.5	6.35	11	0.85	0.8	1.0	
	16-1.0ISO	●				1.0	9.525	16	0.58	0.6	0.7	
	16-1.25ISO					1.25	9.525	16	0.72	0.8	0.9	
	16-1.5ISO	●				1.5	9.525	16	0.85	0.8	1.0	
	16-1.75ISO					1.75	9.525	16	1.01	0.9	1.2	
	16-2.0ISO	●				2.0	9.525	16	1.12	1.0	1.3	
	16-2.5ISO	●				2.5	9.525	16	1.44	1.1	1.5	
	16-3.0ISO	●				3.0	9.525	16	1.69	1.1	1.5	

➔ Applicable holders D32

● : Stock item

ISO Metric (U chip breaker)

Type	Designation (Right)	PC3030T	PC5300	Designation (Left)	PC3030T	Pitch	Dimensions (mm)					Picture
						(mm)	d	L	hmin	X	f	
Internal	IRM 16-1.5ISO-U					1.5	9.525	16	0.85	0.8	1.0	
	16-2.0ISO-U					2.0	9.525	16	1.12	1.0	1.3	

➔ Applicable holders D32

● : Stock item

American UN (UN, UNC, UNF, UNEF, UNS)

Type	Designation (Right)	PC3030T	PC9070T	Designation (Left)	PC3030T	PC9070T	Pitch	Dimensions (mm)					Picture
							(tpi)	d	L	hmin	X	f	
External	ER 11-72UN	●		EL 11-72UN			72	6.35	11	0.22	0.8	0.4	
	11-64UN	●		11-64UN			64	6.35	11	0.24	0.8	0.4	
	11-56UN	●		11-56UN			56	6.35	11	0.28	0.7	0.4	
	11-48UN	●		11-48UN			48	6.35	11	0.32	0.6	0.6	
	11-44UN	●		11-44UN			44	6.35	11	0.35	0.6	0.6	
	11-40UN	●		11-40UN			40	6.35	11	0.39	0.6	0.6	
	11-36UN	●		11-36UN			36	6.35	11	0.43	0.6	0.6	
	11-32UN	●		11-32UN			32	6.35	11	0.49	0.6	0.6	
	11-28UN	●		11-28UN			28	6.35	11	0.56	0.6	0.7	
	11-27UN	●		11-27UN			27	6.35	11	0.58	0.7	0.8	
	11-24UN	●		11-24UN			24	6.35	11	0.65	0.7	0.8	
	11-20UN	●		11-20UN			20	6.35	11	0.78	0.8	0.9	
	11-18UN	●		11-18UN			18	6.35	11	0.87	0.8	1.0	
	11-16UN	●		11-16UN			16	6.35	11	0.97	0.9	1.1	
	11-14UN	●		11-14UN			14	6.35	11	1.11	0.9	1.1	
	16-72UN			16-72UN			72	9.525	16	0.22	0.8	0.4	
	16-64UN			16-64UN			64	9.525	16	0.24	0.8	0.4	
	16-56UN			16-56UN			56	9.525	16	0.28	0.7	0.4	
	16-48UN			16-48UN			48	9.525	16	0.32	0.6	0.6	
	16-44UN			16-44UN			44	9.525	16	0.35	0.6	0.6	
	16-40UN			16-40UN			40	9.525	16	0.39	0.6	0.6	
	16-36UN			16-36UN			36	9.525	16	0.43	0.6	0.6	
	16-32UN	●		16-32UN			32	9.525	16	0.49	0.6	0.6	
	16-28UN	●		16-28UN			28	9.525	16	0.56	0.6	0.7	
	16-27UN	●		16-27UN			27	9.525	16	0.58	0.7	0.8	
	16-24UN	●	●	16-24UN			24	9.525	16	0.65	0.7	0.8	
	16-20UN	●	●	16-20UN			20	9.525	16	0.78	0.8	0.9	
	16-18UN	●	●	16-18UN	●		18	9.525	16	0.87	0.8	1.0	
	16-16UN	●	●	16-16UN	●		16	9.525	16	0.97	0.9	1.1	
	16-14UN	●	●	16-14UN			14	9.525	16	1.11	1.0	1.2	
	16-13UN			16-13UN			13	9.525	16	1.20	1.0	1.3	
	16-12UN	●	●	16-12UN			12	9.525	16	1.30	1.1	1.4	
	16-11.5UN			16-11.5UN			11.5	9.525	16	1.35	1.1	1.5	
	16-11UN	●	●	16-11UN			11	9.525	16	1.42	1.1	1.5	
	16-10UN	●	●	16-10UN			10	9.525	16	1.56	1.1	1.5	
	16-9UN	●		16-9UN			9	9.525	16	1.73	1.2	1.7	
	16-8UN	●	●	16-8UN			8	9.525	16	1.95	1.2	1.6	
	22-7UN			22-7UN			7	12.7	22	2.22	1.6	2.3	
	22-6UN			22-6UN			6	12.7	22	2.60	1.6	2.3	
	22-5UN	●		22-5UN			5	12.7	22	3.12	1.7	2.5	
	27-4.5UN			27-4.5UN			4.5	15.875	27	3.46	1.9	2.7	
	27-4UN			27-4UN			4	15.875	27	3.89	2.1	3.0	

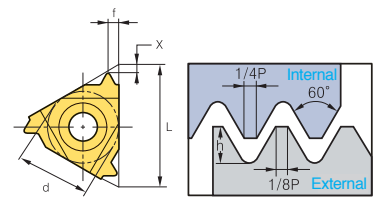
Applicable holders D31

●: Stock item



American UN (UN, UNC, UNF, UNEF, UNS)

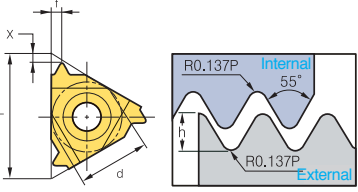
Type	Designation (Right)	PC3030T	PC9070T	Designation (Left)	PC3030T	PC9070T	Pitch (tpi)	Dimensions (mm)					Picture
								d	L	hmin	X	f	
Internal	IR 11-72UN			IL 11-72UN			72	6.35	11	0.20	0.8	0.3	
	11-64UN			11-64UN			64	6.35	11	0.23	0.8	0.4	
	11-56UN			11-56UN			56	6.35	11	0.26	0.7	0.4	
	11-48UN			11-48UN			48	6.35	11	0.31	0.6	0.6	
	11-44UN			11-44UN			44	6.35	11	0.33	0.6	0.6	
	11-40UN			11-40UN			40	6.35	11	0.37	0.6	0.6	
	11-36UN			11-36UN			36	6.35	11	0.41	0.6	0.6	
	11-32UN			11-32UN			32	6.35	11	0.46	0.6	0.6	
	11-28UN			11-28UN			28	6.35	11	0.52	0.6	0.7	
	11-27UN			11-27UN			27	6.35	11	0.54	0.7	0.8	
	11-24UN			11-24UN			24	6.35	11	0.61	0.7	0.8	
	11-20UN		●	11-20UN			20	6.35	11	0.73	0.8	0.9	
	11-18UN	●		11-18UN			18	6.35	11	0.81	0.8	1.0	
	11-16UN		●	11-16UN			16	6.35	11	0.92	0.9	1.1	
	11-14UN	●		11-14UN			14	6.35	11	1.05	0.9	1.1	
	11-12UN		●	11-12UN			12	6.35	11	1.22	0.8	1.1	
	11-11UN	●		11-11UN	●		11	6.35	11	1.33	0.8	1.1	
	16-72UN			16-72UN			72	9.525	16	0.20	0.8	0.3	
	16-64UN			16-64UN			64	9.525	16	0.23	0.8	0.4	
	16-56UN			16-56UN			56	9.525	16	0.26	0.7	0.4	
	16-48UN			16-48UN			48	9.525	16	0.31	0.6	0.6	
	16-44UN			16-44UN			44	9.525	16	0.33	0.6	0.6	
	16-40UN			16-40UN			40	9.525	16	0.37	0.6	0.6	
	16-36UN			16-36UN			36	9.525	16	0.41	0.6	0.6	
	16-32UN			16-32UN			32	9.525	16	0.51	0.6	0.6	
	16-28UN	●		16-28UN			28	9.525	16	0.52	0.6	0.7	
	16-27UN			16-27UN			27	9.525	16	0.54	0.7	0.8	
	16-24UN			16-24UN			24	9.525	16	0.61	0.7	0.8	
	16-20UN	●		16-20UN			20	9.525	16	0.73	0.8	0.9	
	16-18UN	●	●	16-18UN			18	9.525	16	0.81	0.8	1.0	
	16-16UN	●	●	16-16UN			16	9.525	16	0.92	0.9	1.1	
	16-14UN	●		16-14UN			14	9.525	16	1.05	0.9	1.2	
	16-13UN			16-13UN			13	9.525	16	1.13	1.0	1.3	
	16-12UN	●	●	16-12UN			12	9.525	16	1.22	1.1	1.4	
	16-11.5UN	●		16-11.5UN			11.5	9.525	16	1.28	1.1	1.5	
	16-11UN	●	●	16-11UN			11	9.525	16	1.33	1.1	1.5	
	16-10UN	●		16-10UN	●		10	9.525	16	1.47	1.1	1.5	
	16-9UN		●	16-9UN			9	9.525	16	1.63	1.2	1.7	
	16-8UN	●	●	16-8UN	●		8	9.525	16	1.83	1.2	1.5	
	22-7UN			22-7UN			7	12.7	22	2.09	1.6	2.3	
	22-6UN			22-6UN			6	12.7	22	2.44	1.6	2.3	
	22-5UN			22-5UN			5	12.7	22	2.93	1.7	2.3	
	27-4.5UN			27-4.5UN			4.5	15.875	27	3.26	1.9	2.4	
	27-4UN			27-4UN			4	15.875	27	3.67	2.1	2.7	



➡ Applicable holders D32

● : Stock item

Whitworth (BSW, BSF, BSP, BSB)

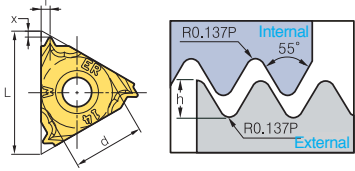
Type	Designation (Right)	PC3030T	PC9070T	Designation (Left)	PC3030T	PC9070T	Pitch (tpi)	Dimensions (mm)					Picture
								d	L	hmin	X	f	
External	ER 11-72W	●		EL 11-72W			72	6.35	11	0.23	0.7	0.4	
	11-60W	●		11-60W			60	6.35	11	0.27	0.7	0.4	
	11-56W	●		11-56W			56	6.35	11	0.29	0.7	0.4	
	11-48W	●		11-48W			48	6.35	11	0.34	0.6	0.6	
	11-40W	●		11-40W			40	6.35	11	0.41	0.6	0.6	
	11-36W	●		11-36W			36	6.35	11	0.45	0.6	0.6	
	11-32W	●		11-32W			32	6.35	11	0.51	0.6	0.6	
	11-28W	●		11-28W			28	6.35	11	0.58	0.6	0.7	
	11-26W	●		11-26W			26	6.35	11	0.63	0.7	0.8	
	11-24W	●		11-24W			24	6.35	11	0.68	0.7	0.8	
	11-22W	●		11-22W			22	6.35	11	0.74	0.8	0.9	
	11-20W	●		11-20W			20	6.35	11	0.81	0.8	0.9	
	11-19W	●		11-19W			19	6.35	11	0.86	0.8	1.0	
	11-18W	●		11-18W			18	6.35	11	0.90	0.8	1.0	
	11-16W	●		11-16W			16	6.35	11	1.02	0.9	1.1	
	11-14W	●		11-14W	●		14	6.35	11	1.16	1.0	1.2	
	16-72W	●		16-72W			72	9.525	16	0.23	0.7	0.4	
	16-60W	●		16-60W			60	9.525	16	0.27	0.7	0.4	
	16-56W	●		16-56W			56	9.525	16	0.29	0.7	0.4	
	16-48W	●		16-48W			48	9.525	16	0.34	0.6	0.6	
	16-40W	●		16-40W			40	9.525	16	0.41	0.6	0.6	
	16-36W	●		16-36W			36	9.525	16	0.45	0.6	0.6	
	16-32W	●		16-32W			32	9.525	16	0.51	0.6	0.6	
	16-30W	●		16-30W			30	9.525	16	0.55	0.6	0.7	
	16-28W	●	●	16-28W			28	9.525	16	0.58	0.6	0.7	
	16-26W			16-26W			26	9.525	16	0.63	0.7	0.8	
	16-24W	●		16-24W			24	9.525	16	0.68	0.7	0.8	
	16-22W	●		16-22W			22	9.525	16	0.74	0.8	0.9	
	16-20W	●		16-20W			20	9.525	16	0.81	0.8	0.9	
	16-19W	●	●	16-19W			19	9.525	16	0.86	0.8	1.0	
	16-18W	●		16-18W			18	9.525	16	0.90	0.8	1.0	
	16-16W	●		16-16W			16	9.525	16	1.02	0.9	1.1	
	16-14W	●	●	16-14W			14	9.525	16	1.16	1.0	1.2	
	16-12W	●		16-12W			12	9.525	16	1.36	1.1	1.4	
	16-11W	●	●	16-11W			11	9.525	16	1.48	1.1	1.5	
	16-10W	●		16-10W			10	9.525	16	1.63	1.1	1.5	
	16-9W	●		16-9W			9	9.525	16	1.81	1.2	1.7	
	16-8W	●		16-8W			8	9.525	16	2.03	1.2	1.5	
	22-7W	●		22-7W			7	12.7	22	3.32	1.6	2.3	
	22-6W	●		22-6W	●		6	12.7	22	2.71	1.6	2.3	
	22-5W	●		22-5W			5	12.7	22	3.25	1.7	2.4	
	27-4.5W	●		27-4.5W			4.5	15.875	27	3.61	1.8	2.6	
	27-4W			27-4W			4	15.875	27	4.07	2.0	2.9	

➔ Applicable holders D31

●: Stock item



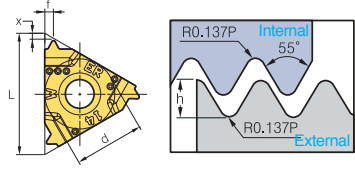
Whitworth (M chip breaker)

Type	Designation (Right)	PC3030T	PC5300	Designation (Left)	PC3030T	Pitch	Dimensions (mm)					Picture
						(tpi)	d	L	hmin	X	f	
External	ERM 16-11W	●				14	9.525	16	1.16	1.0	1.2	
	16-14W	●				11	9.525	16	1.48	1.1	1.5	
	16-19W	●					19	9.525	16	0.86	0.8	

↻ Applicable holders D31

● : Stock item

Whitworth (U chip breaker)

Type	Designation (Right)	PC3030T	PC5300	Designation (Left)	PC3030T	Pitch	Dimensions (mm)					Picture
						(tpi)	d	L	hmin	X	f	
External	ERM 16-14W-U					14	9.525	16	1.16	1.0	1.2	
	16-11W-U					11	9.525	16	1.48	1.1	1.5	

↻ Applicable holders D31

● : Stock item

Whitworth (BSW, BSF, BSP, BSB)

Type	Designation (Right)	PC3030T	PC9070T	Designation (Left)	PC3030T	PC9070T	Pitch (tpi)	Dimensions (mm)					Picture
								d	L	hmin	X	f	
Internal	IR 11-72W	●		IL 11-72W			72	6.35	11	0.23	0.7	0.4	
	11-60W	●		11-60W			60	6.35	11	0.27	0.7	0.4	
	11-56W	●		11-56W			56	6.35	11	0.29	0.7	0.4	
	11-48W	●		11-48W			48	6.35	11	0.34	0.6	0.6	
	11-40W	●		11-40W			40	6.35	11	0.41	0.6	0.6	
	11-36W	●		11-36W			36	6.35	11	0.45	0.6	0.6	
	11-32W	●		11-32W			32	6.35	11	0.51	0.6	0.6	
	11-28W	●		11-28W			28	6.35	11	0.58	0.6	0.7	
	11-26W	●		11-26W			26	6.35	11	0.63	0.7	0.8	
	11-24W	●		11-24W			24	6.35	11	0.68	0.7	0.8	
	11-22W	●		11-22W			22	6.35	11	0.74	0.8	0.9	
	11-20W			11-20W			20	6.35	11	0.81	0.8	0.9	
	11-19W	●	●	11-19W	●		19	6.35	11	0.86	0.8	1.0	
	11-18W	●		11-18W	●		18	6.35	11	0.90	0.8	1.0	
	11-16W	●		11-16W	●		16	6.35	11	1.02	0.9	1.1	
	11-14W	●		11-14W	●		14	6.35	11	1.16	0.9	1.1	
	11-12W	●		11-12W	●		12	6.35	11	1.32	0.9	1.2	
	16-72W	●		16-72W			72	9.525	16	0.23	0.7	0.4	
	16-60W	●		16-60W			60	9.525	16	0.27	0.7	0.4	
	16-56W	●		16-56W			56	9.525	16	0.29	0.7	0.4	
	16-48W	●		16-48W			48	9.525	16	0.34	0.6	0.6	
	16-40W	●		16-40W			40	9.525	16	0.41	0.6	0.6	
	16-36W	●		16-36W			36	9.525	16	0.45	0.6	0.6	
	16-32W	●		16-32W			32	9.525	16	0.51	0.6	0.6	
	16-30W	●		16-30W			30	9.525	16	0.55	0.6	0.7	
	16-28W	●		16-28W			28	9.525	16	0.58	0.6	0.7	
	16-26W	●		16-26W			26	9.525	16	0.63	0.7	0.8	
	16-24W	●		16-24W			24	9.525	16	0.68	0.7	0.8	
	16-22W	●		16-22W			22	9.525	16	0.74	0.8	0.9	
	16-20W	●		16-20W			20	9.525	16	0.81	0.8	0.9	
	16-19W	●		16-19W			19	9.525	16	0.86	0.8	1.0	
	16-18W	●		16-18W			18	9.525	16	0.90	0.8	1.0	
	16-16W	●		16-16W			16	9.525	16	1.02	0.9	1.1	
	16-14W	●	●	16-14W			14	9.525	16	1.16	1.0	1.2	
	16-12W	●		16-12W			12	9.525	16	1.36	1.1	1.4	
	16-11W	●	●	16-11W			11	9.525	16	1.48	1.1	1.5	
	16-10W	●		16-10W			10	9.525	16	1.63	1.1	1.5	
	16-9W	●		16-9W			9	9.525	16	1.81	1.2	1.7	
	16-8W	●		16-8W			8	9.525	16	2.03	1.2	1.5	
	22-7W			22-7W			7	12.7	22	3.32	1.6	2.3	
22-6W	●		22-6W			6	12.7	22	2.71	1.6	2.3		
22-5W	●		22-5W			5	12.7	22	3.25	1.7	2.4		
27-4.5W	●		27-4.5W			4.5	15.875	27	3.61	1.8	2.6		
27-4W	●		27-4W			4	15.875	27	4.07	2.0	2.9		

➔ Applicable holders D32

●: Stock item



Whitworth (M chip breaker)

Type	Designation (Right)	PC3030T	PC5300	Designation (Left)	PC3030T	Pitch (tpi)	Dimensions (mm)					Picture
							d	L	hmin	X	f	
Internal	IRM 16-14W					14	9.525	16	1.16	1.0	1.2	
	16-11W	●				11	9.525	16	1.48	1.1	1.5	

➔ Applicable holders D32

● : Stock item

Whitworth (U chip breaker)

Type	Designation (Right)	PC3030T	PC5300	Designation (Left)	PC3030T	Pitch (tpi)	Dimensions (mm)					Picture
							d	L	hmin	X	f	
Internal	IRM 16-14W-U					14	9.525	16	1.16	1.0	1.2	
	16-11W-U					11	9.525	16	1.48	1.1	1.5	

➔ Applicable holders D32

● : Stock item

British Standard Pipe Thread (BSPT)

Type	Designation (Right)	PC3030T	PC9070T	Designation (Left)	PC3030T	PC9070T	Pitch (tpi)	Dimensions (mm)					Picture
								d	L	hmin	X	f	
External	ER 11-28BSPT			EL 11-28BSPT			28	6.35	11	0.58	0.6		
	11-19BSPT			11-19BSPT			19	6.35	11	0.86	0.8		
	11-14BSPT			11-14BSPT			14	6.35	11	1.16	0.9		
	16-28BSPT			16-28BSPT			28	9.525	16	0.58	0.6		
	16-19BSPT	●	●	16-19BSPT			19	9.525	16	0.86	0.8		
	16-14BSPT		●	16-14BSPT			14	9.525	16	1.16	1.0		
	16-11BSPT	●	●	16-11BSPT			11	9.525	16	1.48	1.1		
Internal	IR 11-28BSPT			IL 11-28BSPT			28	6.35	11	0.58	0.6		
	11-19BSPT		●	11-19BSPT			19	6.35	11	0.86	0.8		
	11-14BSPT		●	11-14BSPT			14	6.35	11	1.16	0.9		
	16-28BSPT			16-28BSPT			28	9.525	16	0.58	0.6		
	16-19BSPT	●	●	16-19BSPT			19	9.525	16	0.86	0.8		
	16-14BSPT	●	●	16-14BSPT			14	9.525	16	1.16	1.0		
	16-11BSPT	●	●	16-11BSPT			11	9.525	16	1.48	1.1		

➔ Applicable holders D31, D32

●: Stock item

National Pipe Thread (NPT)

Type	Designation (Right)	PC3030T	PC9070T	Designation (Left)	PC3030T	PC9070T	Pitch (tpi)	Dimensions (mm)					Picture
								d	L	hmin	X	f	
External	ER 11-27NPT	●		EL 11-27NPT			27	6.35	11	0.66	0.7		
	11-18NPT	●		11-18NPT			18	6.35	11	1.01	0.8		
	11-14NPT	●		11-14NPT			14	6.35	11	1.33	0.8		
	16-27NPT	●		16-27NPT			27	9.525	16	0.66	0.7		
	16-18NPT	●	●	16-18NPT			18	9.525	16	1.01	0.8		
	16-14NPT	●	●	16-14NPT			14	9.525	16	1.33	0.9		
	16-11.5NPT	●		16-11.5NPT			11.5	9.525	16	1.64	1.1		
16-8NPT	●		16-8NPT			8	9.525	16	2.42	1.3			
Internal	IR 11-27NPT	●		IL 11-27NPT			27	6.35	11	0.66	0.7		
	11-18NPT	●		11-18NPT			18	6.35	11	1.01	0.8		
	11-14NPT	●	●	11-14NPT	●		14	6.35	11	1.33	0.8		
	16-27NPT	●		16-27NPT			27	9.525	16	0.66	0.7		
	16-18NPT			16-18NPT			18	9.525	16	1.01	0.8		
	16-14NPT	●	●	16-14NPT			14	9.525	16	1.33	0.9		
	16-11.5NPT	●	●	16-11.5NPT	●		11.5	9.525	16	1.64	1.1		
16-8NPT	●		16-8NPT	●		8	9.525	16	2.42	1.3			

➔ Applicable holders D31, D32

●: Stock item



National Pipe Threads-Dryseal (NPTF)

Type	Designation (Right)	PC3030T	PC9070T	Designation (Left)	PC3030T	PC9070T	Pitch (tpi)	Dimensions (mm)					Picture
								d	L	hmin	X	f	
External	ER 11-27NPTF			EL 11-27NPTF			27	6.35	11	0.64	0.7	0.8	
	11-18NPTF			11-18NPTF			18	6.35	11	1.00	0.8	1.0	
	11-14NPTF			11-14NPTF			14	6.35	11	1.35	0.8	1.0	
	16-27NPTF			16-27NPTF			27	9.525	16	0.64	0.7	0.8	
	16-18NPTF	●		16-18NPTF			18	9.525	16	1.00	0.8	1.0	
	16-14NPTF			16-14NPTF			14	9.525	16	1.35	0.9	1.2	
	16-11.5NPTF			16-11.5NPTF			11.5	9.525	16	1.63	1.1	1.5	
	16-8NPTF			16-8NPTF	●		8	9.525	16	2.38	1.3	1.8	
Internal	IR 11-27NPTF			IL 11-27NPTF			27	6.35	11	0.64	0.7	0.8	
	11-18NPTF			11-18NPTF			18	6.35	11	1.00	0.8	1.0	
	11-14NPTF			11-14NPTF			14	6.35	11	1.35	0.8	1.0	
	16-27NPTF			16-27NPTF			27	9.525	16	0.64	0.7	0.8	
	16-18NPTF			16-18NPTF			18	9.525	16	1.00	0.8	1.0	
	16-14NPTF			16-14NPTF			14	9.525	16	1.35	0.9	1.2	
	16-11.5NPTF			16-11.5NPTF			11.5	9.525	16	1.63	1.1	1.5	
	16-8NPTF			16-8NPTF			8	9.525	16	2.38	1.3	1.8	

Applicable holders D31, D32

● : Stock item

Round DIN 405

Type	Designation (Right)	PC3030T	PC9070T	Designation (Left)	PC3030T	PC9070T	Pitch (tpi)	Dimensions (mm)					Picture
								d	L	hmin	X	f	
External	ER 16-10RD			EL 16-10RD			10	9.525	16	1.27	1.1	1.2	
	16-8RD	●		16-8RD			8	9.525	16	1.59	1.4	1.3	
	16-6RD	●		16-6RD			6	9.525	16	2.12	1.5	1.7	
	22-6RD			22-6RD			6	12.7	22	2.12	1.5	1.7	
	22-4RD	●		22-4RD			4	12.7	22	3.18	2.2	2.3	
	27-4RD			27-4RD			4	15.875	27	3.18	2.2	2.3	
Internal	IR 16-10RD			IL 16-10RD			10	9.525	16	1.27	1.1	1.2	
	16-8RD			16-8RD			8	9.525	16	1.59	1.4	1.4	
	16-6RD	●		16-6RD			6	9.525	16	2.12	1.4	1.5	
	22-6RD			22-6RD			6	12.7	22	2.12	1.5	1.7	
	22-4RD	●		22-4RD			4	12.7	22	3.18	2.2	2.3	
	27-4RD			27-4RD			4	15.875	27	3.18	2.2	2.3	

Applicable holders D31, D32

● : Stock item

D Thread Insert

Type	Designation (Right)	PC3030T	PC9070T	Designation (Left)	PC3030T	PC9070T	Pitch (mm)	Dimensions (mm)					Picture
								d	L	hmin	X	f	
External	ER 11-1.5TR	●		EL 11-1.5TR	●		1.5	6.35	11	0.90	0.8	0.9	
	16-1.5TR			16-1.5TR			1.5	9.525	16	0.90	1.0	1.1	
	16-2.0TR	●		16-2.0TR	●		2.0	9.525	16	1.25	1.1	1.3	
	16-3.0TR	●	●	16-3.0TR	●		3.0	9.525	16	1.75	1.3	1.5	
	22-4.0TR	●	●	22-4.0TR	●		4.0	12.7	22	2.25	1.7	1.9	
	22-5.0TR	●	●	22-5.0TR	●		5.0	12.7	22	2.75	2.1	2.5	
	27-6.0TR	●	●	27-6.0TR	●		6.0	15.875	27	3.50	2.3	2.7	
Internal	IR 11-1.5TR			IL 11-1.5TR	●		1.5	6.35	11	0.90	0.8	0.9	
	16-1.5TR	●		16-1.5TR	●		1.5	9.525	16	0.90	1.0	1.1	
	16-2.0TR	●		16-2.0TR	●		2.0	9.525	16	1.25	1.1	1.3	
	16-2.5TR	●		16-2.5TR	●		2.5	9.525	16	1.53	1.2	1.4	
	16-3.0TR	●		16-3.0TR	●		3.0	9.525	16	1.75	1.3	1.5	
	22-4.0TR	●	●	22-4.0TR	●		4.0	12.7	22	2.25	1.7	1.9	
	27-6.0TR	●	●	27-6.0TR	●		6.0	15.875	27	3.50	2.3	2.7	

Applicable holders D31, D32

●: Stock item

Type	Designation (Right)	PC3030T	PC9070T	Designation (Left)	PC3030T	PC9070T	Pitch (tpi)	Dimensions (mm)					Picture
								d	L	hmin	X	f	
External	ER 11-16ACME			EL 11-16ACME			16	6.35	11	0.92	1.0	1.1	
	16-16ACME			16-16ACME			16	9.525	16	0.92	1.0	1.1	
	16-14ACME			16-14ACME			14	9.525	16	1.03	1.0	1.2	
	16-12ACME			16-12ACME			12	9.525	16	1.19	1.1	1.2	
	16-10ACME			16-10ACME			10	9.525	16	1.52	1.3	1.4	
	16-8ACME			16-8ACME			8	9.525	16	1.84	1.4	1.5	
	16-6ACME			16-6ACME			6	9.525	16	2.37	1.7	1.9	
	22-6ACME	●		22-6ACME	●		6	12.7	22	2.37	1.8	2.1	
	22-5ACME	●		22-5ACME	●		5	12.7	22	2.79	2.0	2.3	
	27-4ACME			27-4ACME			4	15.875	27	3.43	2.4	2.7	
Internal	IR 11-16ACME			IL 11-16ACME			16	6.35	11	0.92	0.9	0.9	
	16-16ACME			16-16ACME			16	9.525	16	0.92	1.0	1.1	
	16-14ACME			16-14ACME			14	9.525	16	1.03	1.1	1.2	
	16-12ACME			16-12ACME			12	9.525	16	1.19	1.2	1.3	
	16-10ACME	●		16-10ACME			10	9.525	16	1.52	1.2	1.3	
	16-8ACME	●		16-8ACME			8	9.525	16	1.84	1.4	1.5	
	16-6ACME			16-6ACME			6	9.525	16	2.37	1.7	1.9	
	22-6ACME	●		22-6ACME			6	12.7	22	2.37	1.8	2.1	
	22-5ACME	●		22-5ACME			5	12.7	22	2.79	2.0	2.3	
	27-4ACME	●		27-4ACME			4	15.875	27	3.43	2.3	2.6	

●: Stock item



UNJ (Unified Constant Thread)

Type	Designation (Right)		Designation (Left)	Pitch		Dimensions (mm)					Picture		
	PC3030T	PC9070T		PC3030T	PC9070T	(tpi)	d	L	hmin	X		f	
External	ER	11-48UNJ		EL	11-48UNJ		48	6.35	11	0.31	0.6	0.5	
		11-44UNJ			11-44UNJ		44	6.35	11	0.33	0.6	0.6	
		11-40UNJ			11-40UNJ		40	6.35	11	0.37	0.6	0.6	
		11-36UNJ			11-36UNJ		36	6.35	11	0.41	0.6	0.6	
		11-32UNJ			11-32UNJ		32	6.35	11	0.46	0.6	0.7	
		11-28UNJ			11-28UNJ		28	6.35	11	0.52	0.7	0.7	
		11-24UNJ	●		11-24UNJ		24	6.35	11	0.61	0.7	0.8	
		11-20UNJ			11-20UNJ		20	6.35	11	0.73	0.8	0.9	
		11-18UNJ			11-18UNJ		18	6.35	11	0.81	0.8	1.0	
		11-16UNJ			11-16UNJ		16	6.35	11	0.92	0.9	1.1	
		11-14UNJ			11-14UNJ		14	6.35	11	1.05	1.0	1.2	
		16-48UNJ			16-48UNJ		48	9.525	16	0.31	0.6	0.5	
		16-44UNJ			16-44UNJ		44	9.525	16	0.33	0.6	0.6	
		16-40UNJ			16-40UNJ		40	9.525	16	0.37	0.6	0.6	
		16-36UNJ			16-36UNJ		36	9.525	16	0.41	0.6	0.6	
		16-32UNJ	●		16-32UNJ		32	9.525	16	0.46	0.6	0.7	
		16-28UNJ	●		16-28UNJ		28	9.525	16	0.52	0.7	0.7	
		16-24UNJ	●		16-24UNJ		24	9.525	16	0.61	0.7	0.8	
		16-20UNJ	●		16-20UNJ		20	9.525	16	0.73	0.8	0.9	
		16-18UNJ			16-18UNJ		18	9.525	16	0.81	0.8	1.0	
		16-16UNJ	●		16-16UNJ		16	9.525	16	0.92	0.9	1.1	
		16-14UNJ			16-14UNJ		14	9.525	16	1.05	1.0	1.2	
		16-13UNJ			16-13UNJ		13	9.525	16	1.13	1.0	1.3	
		16-12UNJ	●		16-12UNJ		12	9.525	16	1.22	1.1	1.3	
		16-11UNJ			16-11UNJ		11	9.525	16	1.33	1.2	1.5	
		16-10UNJ			16-10UNJ	●	10	9.525	16	1.47	1.2	1.5	
		16-9UNJ			16-9UNJ		9	9.525	16	1.63	1.3	1.7	
		16-8UNJ			16-8UNJ		8	9.525	16	1.83	1.2	1.6	
		22-7UNJ			22-7UNJ		7	12.7	22	2.09	1.7	2.3	
		22-6UNJ			22-6UNJ		6	12.7	22	2.44	1.7	2.3	
		22-5UNJ			22-5UNJ		5	12.7	22	2.93	1.8	2.5	
		27-4.5UNJ			27-4.5UNJ		4.5	15.875	27	3.26	2.0	2.7	
		27-4UNJ			27-4UNJ		4	15.875	27	3.67	2.2	3.0	

➔ Applicable holders D31

●: Stock item



UNJ (Unified Constant Thread)

Type	Designation (Right)	PC3030T	PC9070T	Designation (Left)	PC3030T	PC9070T	Pitch (tpi)	Dimensions (mm)					Picture
								d	L	hmin	X	f	
Internal	IR 11-48UNJ			IL 11-48UNJ			48	6.35	11	0.28	0.6	0.5	
	11-44UNJ			11-44UNJ			44	6.35	11	0.30	0.6	0.6	
	11-40UNJ			11-40UNJ			40	6.35	11	0.33	0.6	0.6	
	11-36UNJ			11-36UNJ			36	6.35	11	0.37	0.6	0.6	
	11-32UNJ			11-32UNJ			32	6.35	11	0.42	0.6	0.7	
	11-28UNJ			11-28UNJ			28	6.35	11	0.47	0.7	0.7	
	11-24UNJ			11-24UNJ			24	6.35	11	0.55	0.7	0.8	
	11-20UNJ			11-20UNJ			20	6.35	11	0.66	0.8	0.9	
	11-18UNJ			11-18UNJ			18	6.35	11	0.74	0.8	1.0	
	11-16UNJ			11-16UNJ			16	6.35	11	0.83	0.9	1.1	
	11-14UNJ			11-14UNJ			14	9.525	11	0.95	1.0	1.2	
	16-48UNJ			16-48UNJ			48	9.525	16	0.28	0.6	0.5	
	16-44UNJ			16-44UNJ			44	9.525	16	0.30	0.6	0.6	
	16-40UNJ			16-40UNJ			40	9.525	16	0.33	0.6	0.6	
	16-36UNJ			16-36UNJ			36	9.525	16	0.37	0.6	0.6	
	16-32UNJ			16-32UNJ			32	9.525	16	0.42	0.6	0.7	
	16-28UNJ			16-28UNJ			28	9.525	16	0.47	0.7	0.7	
	16-24UNJ			16-24UNJ			24	9.525	16	0.55	0.7	0.8	
	16-20UNJ			16-20UNJ			20	9.525	16	0.66	0.8	0.9	
	16-18UNJ			16-18UNJ			18	9.555	16	0.74	0.8	1.0	
	16-16UNJ			16-16UNJ			16	9.525	16	0.83	0.9	1.1	
	16-14UNJ			16-14UNJ			14	9.525	16	0.95	1.0	1.2	
	16-13UNJ			16-13UNJ			13	9.525	16	1.02	1.0	1.3	
	16-12UNJ			16-12UNJ	●		12	9.525	16	1.11	1.1	1.3	
	16-11UNJ			16-11UNJ			11	9.525	16	1.21	1.2	1.5	
	16-10UNJ			16-10UNJ			10	9.525	16	1.33	1.2	1.5	
	16-9UNJ			16-9UNJ			9	9.525	16	1.48	1.3	1.7	
	16-8UNJ			16-8UNJ			8	9.525	16	1.66	1.2	1.6	
	22-7UNJ			22-7UNJ			7	12.7	22	1.90	1.7	2.3	
	22-6UNJ			22-6UNJ			6	12.7	22	2.21	1.7	2.3	
	22-5UNJ			22-5UNJ			5	12.7	22	2.66	1.8	2.5	
	27-4.5UNJ			27-4.5UNJ			4.5	15.875	27	2.95	2.0	2.7	
	27-4UNJ			27-4UNJ			4	15.875	27	3.32	2.2	3.0	

➔ Applicable holders D32

● : Stock item

American Buttress (ABUT)

Type	Designation (Right)	PC3030T	PC9070T	Designation (Left)	PC3030T	PC9070T	Pitch (tpi)	Dimensions (mm)					Picture
								d	L	hmin	X	f	
External	ER 11-20ABUT			EL 11-20ABUT			20	6.35	11	0.84	1.0	1.4	
	11-16ABUT			11-16ABUT			16	6.35	11	1.05	1.3	1.9	
	16-20ABUT	●		16-20ABUT			20	9.525	16	0.84	1.0	1.4	
	16-16ABUT			16-16ABUT			16	9.525	16	1.05	1.3	1.9	
	16-12ABUT			16-12ABUT			12	9.525	16	1.40	1.4	2.0	
	16-10ABUT			16-10ABUT			10	9.525	16	1.68	1.5	2.3	
	22-8ABUT			22-8ABUT			8	12.7	22	2.10	2.0	3.2	
	22-6ABUT			22-6ABUT			6	12.7	22	2.80	2.2	3.5	
Internal	IR 11-20ABUT	●		IL 11-20ABUT			20	6.35	11	0.84	1.0	1.4	
	11-16ABUT			11-16ABUT			16	6.35	11	1.05	1.3	1.9	
	16-20ABUT	●		16-20ABUT			20	9.525	16	0.84	1.0	1.4	
	16-16ABUT			16-16ABUT			16	9.525	16	1.05	1.3	1.9	
	16-12ABUT	●		16-12ABUT			12	9.525	16	1.40	1.4	2.0	
	16-10ABUT	●		16-10ABUT			10	9.525	16	1.68	1.5	2.3	
	22-8ABUT			22-8ABUT			8	12.7	22	2.10	2.0	3.2	
	22-6ABUT			22-6ABUT			6	12.7	22	2.80	2.2	3.5	

Applicable holders D31, D32

●: Stock item

British Buttress (BBUT)

Type	Designation (Right)	PC3030T	PC9070T	Designation (Left)	PC3030T	PC9070T	Pitch (tpi)	Dimensions (mm)					Picture
								d	L	hmin	X	f	
External	ER 16-16BBUT	●		EL 16-16BBUT			16	9.525	16	0.80	1.1	1.6	
	16-12BBUT			16-12BBUT			12	9.525	16	1.07	1.4	2.1	
	16-10BBUT			16-10BBUT			10	9.525	16	1.28	1.4	2.2	
	16-8BBUT	●		16-8BBUT			8	9.525	16	1.61	1.6	2.5	
	22-8BBUT			22-8BBUT			8	12.7	22	1.61	1.6	2.5	
Internal	IR 16-16BBUT	●		IL 16-16BBUT			16	9.525	16	0.80	1.1	1.6	
	16-12BBUT			16-12BBUT			12	9.525	16	1.07	1.4	2.1	
	16-10BBUT			16-10BBUT			10	9.525	16	1.28	1.4	2.2	
	16-8BBUT			16-8BBUT			8	9.525	16	1.61	1.6	2.5	
	22-8BBUT			22-8BBUT			8	12.7	22	1.61	1.6	2.5	

Applicable holders D31, D32

●: Stock item

Metric Buttress (SAGE)

Type	Designation (Right)	PC3030T	PC9070T	Designation (Left)	PC3030T	PC9070T	Pitch (mm)	Dimensions (mm)					Picture
								d	L	hmin	X	f	
External	ER 16-2.0SAGE			EL 16-2.0SAGE			2.0	9.525	16	1.74	1.47	2.08	
	22-2.0SAGE			22-2.0SAGE			2.0	12.7	22	1.74	1.47	2.08	
	22-3.0SAGE	●		22-3.0SAGE			3.0	12.7	22	2.60	1.79	2.60	
	27-4.0SAGE	●		27-4.0SAGE			4.0	15.875	27	3.55	1.93	3.20	
Internal	IR 16-2.0SAGE	●		IL 16-2.0SAGE			2.0	9.525	16	1.50	1.52	2.2	
	22-3.0SAGE			22-3.0SAGE			3.0	12.7	22	2.25	1.66	2.9	
	27-4.0SAGE	●		27-4.0SAGE			4.0	5/8	27	3.09	2.12	3.2	

➤ Applicable holders D31, D32

● : Stock item

API

Type	Designation (Right)	PC3030T	PC9070T	Designation (Left)	PC3030T	PC9070T	Pitch (tpi)	Dimensions (mm)					Picture
								d	L	hmin	X	f	
External	ER 22-4API382	●		EL 22-4API382			4	12.7	22	3.09	2.1	2.8	
	22-4API383			22-4API383			4	12.7	22	3.08	2.1	2.8	
	22-4API502	●		22-4API502			4	12.7	22	3.75	2.0	2.9	
	22-4API503	●		22-4API503			4	12.7	22	3.74	2.0	2.9	
	22-5API403			22-5API403			5	12.7	22	2.99	1.8	2.6	
	22-6API551			22-6API551			6	12.7	22	1.41	2.6	2.0	
	27-4API382	●		27-4API382			4	15.875	27	3.09	2.1	2.8	
	27-4API383			27-4API383			4	15.875	27	3.08	2.1	2.8	
	27-4API502			27-4API502			4	15.875	27	3.75	2.1	3.1	
	27-4API503	●		27-4API503			4	15.875	27	3.74	2.1	3.1	
27-5API403	●		27-5API403			5	15.875	27	2.99	1.9	2.7		
Internal	IR 22-4API382			IL 22-4API382			4	12.7	22	3.09	2.1	2.8	
	22-4API383			22-4API383			4	12.7	22	3.08	2.1	2.8	
	22-4API502	●		22-4API502			4	12.7	22	3.75	2.1	3.1	
	22-4API503			22-4API503			4	12.7	22	3.74	2.0	2.9	
	22-5API403	●		22-5API403			5	12.7	22	2.99	1.8	2.6	
	22-6API551	●		22-6API551			6	12.7	22	1.41	2.6	2.0	
	27-4API382			27-4API382			4	15.875	27	3.09	2.1	2.8	
	27-4API383	●		27-4API383			4	15.875	27	3.08	2.1	2.8	
	27-4API502	●		27-4API502			4	15.875	27	3.75	2.1	3.1	
	27-4API503	●		27-4API503			4	15.875	27	3.74	2.1	3.1	
27-5API403	●		27-5API403			5	15.875	27	2.99	1.9	2.7		

➤ Applicable holders D31, D32

● : Stock item

API Buttress Casing (BUT)

Type	Designation (Right)	PC3030T	PC9070T	Designation (Left)	PC3030T	PC9070T	Pitch (tpi)	Dimensions (mm)					Picture	
								IPF	d	L	hmin	X		f
External	ER 22-5BUT75	●		EL 22-5BUT75			5	0.75	12.7	22	1.55	3.1	1.9	
	22-5BUT1			22-5BUT1			5	1	12.7	22	1.55	3.1	1.9	
Internal	IR 22-5BUT75	●		IL 22-5BUT75			5	0.75	12.7	22	1.55	2.8	1.9	
	22-5BUT1	●		22-5BUT1			5	1	12.7	22	1.55	2.8	1.9	

Applicable holders D31, D32

●: Stock item

API Round Casing & Tubing (APIRD)

Type	Designation (Right)	PC3030T	PC9070T	Designation (Left)	PC3030T	PC9070T	Pitch (tpi)	Dimensions (mm)					Picture
								d	L	hmin	X	f	
External	ER 16-10APIRD	●		EL 16-10APIRD			10	9.525	16	1.41	1.2	1.4	
	16-8APIRD	●		16-8APIRD			8	9.525	16	1.81	1.3	1.5	
Internal	IR 16-10APIRD	●		IL 16-10APIRD			10	9.525	16	1.41	1.2	1.4	
	16-8APIRD	●		16-8APIRD			8	9.525	16	1.81	1.3	1.5	

Applicable holders D31, D32

●: Stock item

Extreme Line Casing (EL)

Type	Designation (Right)	PC3030T	PC9070T	Designation (Left)	PC3030T	PC9070T	Pitch (tpi)	Dimensions (mm)					Picture	
								IPF	d	L	hmin	X		f
External	ER 22-6EL15			EL 22-6EL15			6	1.5	12.7	22	1.21	1.9	1.9	
	22-5EL125			22-5EL125			5	1.25	12.7	22	1.71	2.3	2.4	
Internal	IR 22-6EL15			IL 22-6EL15			6	1.5	12.7	22	1.39	1.8	1.9	
	22-5EL125			22-5EL125			5	1.25	12.7	22	1.91	2.2	2.4	

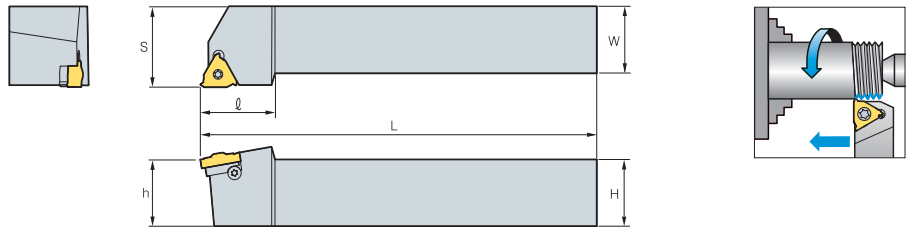
Applicable holders D31, D32

●: Stock item



ER(L)H

(Screw on system)



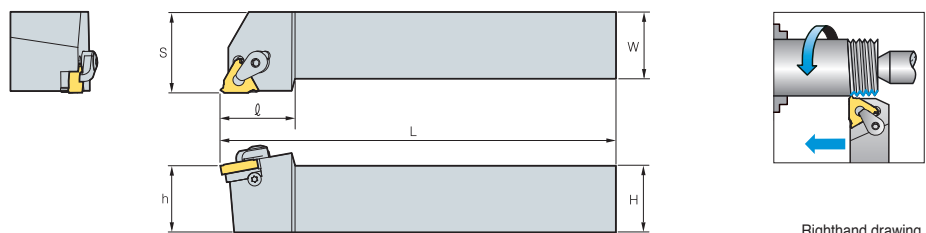
Righthand drawing (mm)

Designation	Inscribed circle	H	W	L	S	H	ℓ	Insert screw	Shim screw	Screw RH	Screw LH	Wrench	
ER(L)H	08N-11	6.35	8	8	136.4	11	8	17.5					
	10N-11	6.35	10	10	70.0	11	10	17.5	ST11N	-	-	-	TW08P
	12N-11	6.35	12	12	80.0	12	12	17.5					
	12N-16	9.525	12	12	83.2	16	12	22	ST16N	-	-	-	TW10P
	09-16	9.525	9.52	9.52	63.6	16	9.52	20.5					
	12-16	9.525	12	12	83.2	16	12	22					
	16-16	9.525	16	16	100.0	16	16	20.5					
	20-16	9.525	20	20	128.6	20	20	30	ST16	STA16	ATE16	ATI22	TW10P
	25-16	9.525	25	25	153.6	25	25	30					
	32-16	9.525	32	32	173.6	32	32	30					
	25-22	12.7	25	25	155.7	25	25	36					
	32-22	12.7	32	32	175.7	32	32	36	ST22	STA22	ATE22	ATI22	TW20P
	40-22	12.7	40	40	205.7	40	40	36					
	25-27	15.875	25	25	151.6	32	25	35					
	32-27	15.875	32	32	176.6	32	32	40					
	40-27	15.875	40	40	206.6	40	40	40					
50-27	15.875	50	50	256.6	50	50	40	ST27	STA27	ATE27	ATI27	TW25L	

↻ Applicable inserts D10~D13, D16, D18, D19, D22, D23~D26 • Helix angle is 1.5° for all holders • No shim needed for N type holder

ER(L)H-C

(Clamp on system)

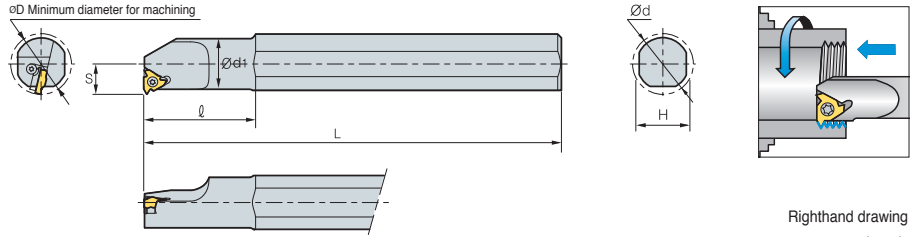


Righthand drawing (mm)

Designation	Inscribed circle	H	W	L	S	H	ℓ	Shim screw	Clamp	Screw RH	Screw LH	Wrench	
ER(L)H	20-16C	9.525	20	20	128.6	20	20	30					
	25-16C	9.525	25	25	153.6	25	25	30	STA16	CTH16	ATE16	ATI16	TW10P TW15P
	32-16C	9.525	32	32	173.6	32	32	30					
	25-22C	12.7	25	25	155.7	25	25	36					
	32-22C	12.7	32	32	175.7	32	32	36	STA22	CTH22	ATE22	ATI22	TW20P
	40-22C	12.7	40	40	205.7	40	40	36					
	25-27C	15.875	25	25	151.6	25	25	35					
	32-27C	15.875	32	32	176.6	32	32	40					
	40-27C	15.875	40	40	206.6	40	40	40					
	50-27C	15.875	50	50	256.6	50	50	40	STA27	CTH27	ATE27	ATI27	TW25L

↻ Applicable inserts D10~D13, D16, D18, D19, D22, D23~D26 • Helix angle is 1.5° for all holders

IR(L)H (Screw on system)



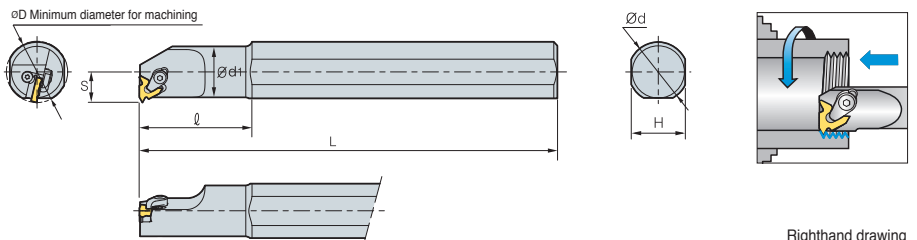
Righthand drawing
(mm)

Designation	Inscribed circle	ØD	Ød	Ød1	H	L	S	l	Insert screw	Shim screw	Screw RH	Screw LH	Wrench	
IR(L)H	10DN-11	6.35	13	10	10.0	9.5	100	7.3	-	-	-	-	-	-
	10N-11	6.35	13	20	10.0	18.0	180	7.3	ST11N	-	-	-	-	TW08P
	13N-11	6.35	16	20	13.0	18.0	180	8.9	-	-	-	-	-	-
	13N-16	9.525	17	20	12.7	18.0	180	10.3	-	-	-	-	-	-
	16N-16	9.525	20	20	16.0	18.0	180	11.5	ST16N	-	-	-	-	TW10P
	16DN-16	9.525	20	16	16.0	15.2	150	11.3	-	-	-	-	-	-
	20-16	9.525	24	20	20.0	18.0	180	13.4	-	-	-	-	-	-
	25-16	9.525	29	32	25.0	29.0	250	16.3	-	-	-	-	-	-
	25D-16	9.525	29	25	24.5	22.6	200	16.1	ST16	STA16	ATI16	ATE16	-	TW10P
	32-16	9.525	36	32	32.0	29.0	250	19.6	-	-	-	-	-	-
	40-16	9.525	44	40	40.0	36.0	300	23.8	-	-	-	-	-	-
	20N-22	12.7	27	20	20.0	18.0	180	15.6	ST22N	-	-	-	-	TW20P
	25-22	12.7	32	32	25.0	29.0	250	17.4	-	-	-	-	-	-
	25D-22	12.7	32	25	24.6	22.6	200	17.2	ST22	STA22	ATI22	ATE22	-	TW20P
	32-22	12.7	39	32	32.0	29.0	250	21.5	-	-	-	-	-	-
40-22	12.7	47	40	40.0	36.0	300	25.8	-	-	-	-	-	-	
32-27	15.875	40	32	32.0	29.0	250	22.4	-	-	-	-	-	-	
40-27	15.875	48	40	40.0	36.0	300	26.4	-	-	-	-	-	-	
50-27	15.875	58	50	50.0	45.0	350	31.4	-	-	-	-	-	-	
60-27	15.875	69	60	60.0	54.0	400	36.4	ST27	STA27	ATI27	ATE27	-	TW25L	

➔ Applicable inserts D10, D11, D14, D15, D17, D20~D25, D27~D30

• Helix angle is 1.5° for all holders • No shim needed for N type holder

IR(L)H-C (Clamp on system)



Righthand drawing
(mm)

Designation	Inscribed circle	ØD	Ød	Ød1	H	L	S	l	Shim screw	Clamp	Screw RH	Screw LH	Wrench
IR(L)H	20-16C	9.525	24	20	20.0	18.0	13.4	50	-	-	-	-	-
	25-16C	9.525	29	32	25.0	28.0	250	16.3	STA16	CTH16	ATI16	ATE16	TW10P
	25D-16C	9.525	29	25	24.6	22.6	200	16.1	-	-	-	-	TW15P
	32-16C	9.525	36	32	32.0	29.0	250	19.6	-	-	-	-	-
	40-16C	9.525	44	40	40.0	36.0	300	23.8	-	-	-	-	-
	25-22C	12.7	32	32	25.0	29.0	250	17.4	-	-	-	-	-
	25D-22C	12.7	32	25	24.6	22.6	200	17.2	-	-	-	-	-
	32-22C	12.7	39	32	32.0	29.0	250	21.5	STA22	CTH22	ATI22	ATE22	TW20P
	40-22C	12.7	47	40	40.0	36.0	300	25.8	-	-	-	-	-
	32-27C	15.875	40	32	32.0	29.0	250	22.4	-	-	-	-	-
	40-27C	15.875	48	40	40.0	36.0	300	26.4	-	-	-	-	-
	50-27C	15.875	58	50	50.0	45.0	350	31.4	-	-	-	-	-
	60-27C	15.875	69	60	60.5	54.0	400	36.4	STA27	CTH27	ATI27	ATE27	TW25L

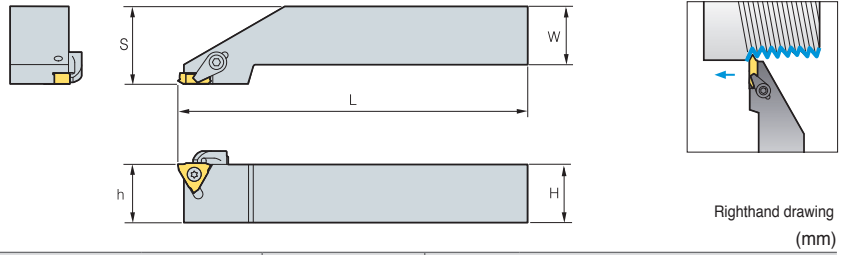
➔ Applicable inserts D10, D11, D14, D15, D17, D20~D25, D27~D30

• Helix angle is 1.5° for all holders

VTH



VETR



Designation		H = (h)	W	L	S	Insert	Clamp	Clamp screw	Screw	Wrench
VTH	2020R	20	20	125	26.4	VETR				
	2525R	25	25	150	33.4					
	3225R	32	25	170	33.4					

Vertical type thread insert

Picture	Designation	Uncoated	Insert			Configuration
		ST10	Pitch (mm)	θ	f	
	VETR 080		0.8	60°	1.4	 d: 9.525 t: 4.76
	100	●	1.0	60°	1.4	
	125		1.25	60°	1.4	
	150	●	1.5	60°	1.2	
	175		1.75	60°	1.2	
	200	●	2.0	60°	1.2	
	250		2.5	60°	1.4	
	300	●	3.0	60°	1.6	
	150F	●	0.8~1.5	60°	1.4	
	300F	●	1.5~3.0	60°	1.6	

● : Stock item

D Technical Information for Thread Milling

Thread milling holders code system

TM	S	R	L	25	-	11
1	2	3	4	5		6
Insert style	Holder style	Hand	Shank type	Shank dia.		Cutting edge length

1	Insert style TM S R L 25 - 11	3	Hand TM S R L 25 - 11	5	Shank dia. TM S R L 25 - 11
Thread Milling Holder		R: Right Hand L: Left Hand		25: 25.0	

2	Holders style TM S R L 25 - 11	4	Shank type TM S R L 25 - 11	6	Cutting edge length TM S R L 25 - 11
S: Shank Type		None: Standard L: Long Type T: Taper Type		10: 10.4 22: 22 11: 11 27: 27 16: 16 38: 38.5	

Thread milling inserts code system

TM	2	I	16	-	1.5	ISO
1	2	3	4		5	6
Insert style	Cutting edge	Type of insert	Cutting edge length		Pitch	Type

1	Insert style TM 2 I 16 - 1.5 ISO	4	Cutting edge length TM 2 I 16 - 1.5 ISO	6	Type TM 2 I 16 - 1.5 ISO
Thread Milling Holder		10: 10.4 11: 11 16: 16 22: 22 27: 27 38: 38.5		ISO Metric American UN (UNC, UNF, UNEF) UNJ Whit Worth (BSW, BSF, BSP, BSB) National Pipe Thread (NPT) National Pipe Thread (NPTF) British Standard Pipe Thread (BSPT)	

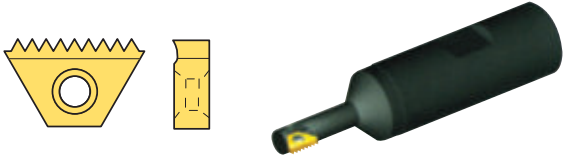
2	Cutting edge TM 2 I 16 - 1.5 ISO	3	Type of insert TM 2 I 16 - 1.5 ISO	5	Pitch TM 2 I 16 - 1.5 ISO
None: 1 cutting edge 2: 2 cutting edge		I: Internal E: External EI: External & Internal		mm: 0.5~6.0 tpi: 48~6	



Thread milling

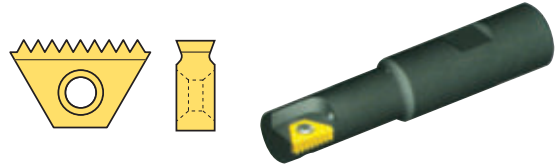
➤ The right tool for the job

Small diameter type



Tool holder: TMSR **Insert:** TM L = 10.4 mm
For small bore diameters down to 9.5 mm

Standard type



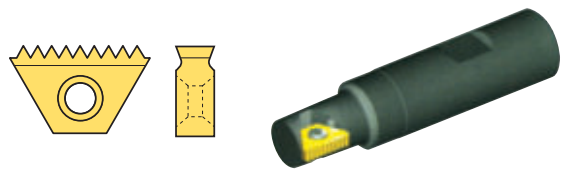
Tool holder: TMSR **Insert:** TM2
For standard length threads

Long type



Tool holder: TMSR **Insert:** TM2
For long or remote threads

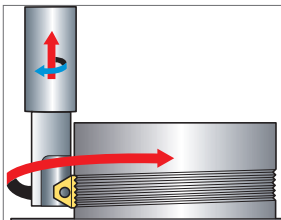
Tapered type



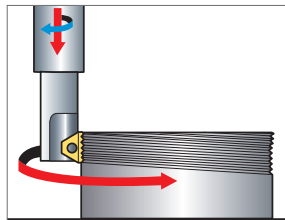
Tool holder: TMSR **Insert:** TM2 (BSPT, NPT, NPTF)
For standard length threads

➤ Thread milling methods

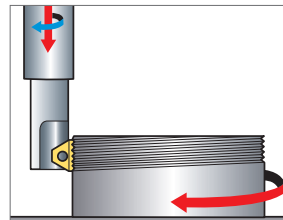
External threading



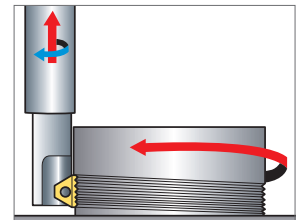
Right handed thread
conventional milling



Left handed thread
down milling

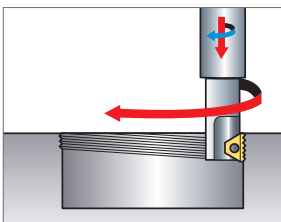


Right handed thread
down milling

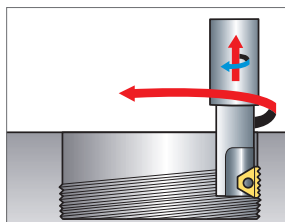


Left handed thread
conventional milling

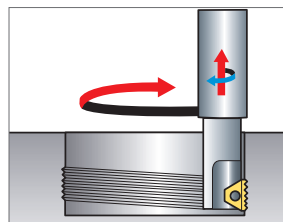
Internal threading



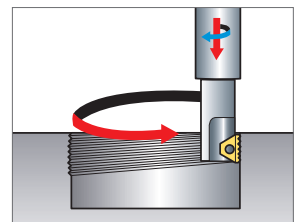
Right handed thread
down milling



Left handed thread
conventional milling



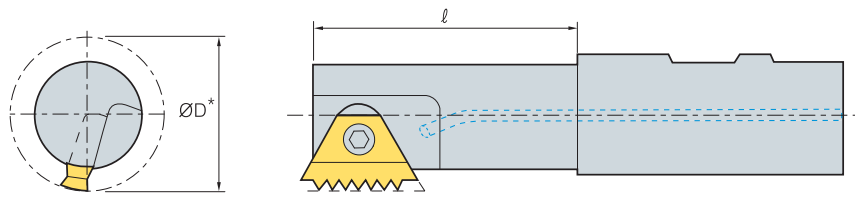
Right handed thread
conventional milling



Left handed thread
down milling

D Technical Information for Thread Milling

Tooling recommendation for given internal thread specification

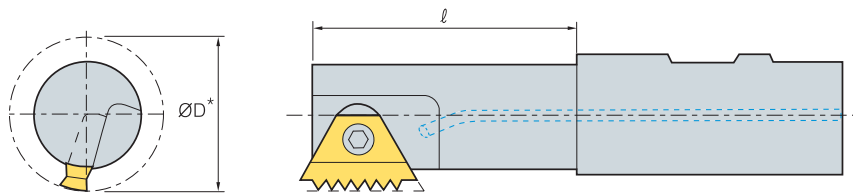


ISO

Pitch (mm)	Nominal dia. (mm)	Holder	Insert	ℓ-Tool holder overhang	D-Tool cutting dia.*	Min.Thread depth (Profile depth)
0.75	11	TMSR 12-10	TM2I 10-0.75ISO	12.0	9.0	0.43
1.0	12-14	TMSR 12-10	TM2I 10-1.0ISO	12.0	9.0	0.58
	15-18	TMSR 12-11	TM2I 11-1.0ISO	12.0	11.5	
	20	TMSR 16-16	TM2I 16-1.0ISO	22.0	17.0	
	22	TMSR 20-22	TM2I 22-1.0ISO	29.0	19.0	
	24	TMSR 20-16	TM2I 16-1.0ISO	43.0	20.0	
	25-28	TMSRL 25-16	TM2I 16-1.0ISO	25.0	22.0	
1.25	14	TMSR 12-10	TM2I 10-1.25ISO	12.0	9.0	0.72
1.5	14-15	TMSR 12-10	TM2I 10-1.5ISO	12.0	9.0	0.87
	16-20	TMSR 12-11	TM2I 11-1.5ISO	12.0	11.5	
	22	TMSR 16-16	TM2I 16-1.5ISO	22.0	17.0	
	24	TMSR 20-22	TM2I 22-1.5ISO	29.0	19.0	
	25-26	TMSR 20-16	TM2I 16-1.5ISO	43.0	20.0	
	27-30	TMSRL 25-16	TM2I 16-1.5ISO	25.0	22.0	
	35-42	TMSR 25-27	TM2I 27-1.5ISO	52.0	30.0	
	45	TMSR 32-27	TM2I 27-1.5ISO	58.0	37.0	
2.0	22	TMSRT 16-16	TM2I16-2.0ISO	22.0	15.5	1.15
	24	TMSR 16-16	TM2I 16-2.0ISO	22.0	17.0	
	25	TMSR 20-22	TM2I 22-2.0ISO	29.0	19.0	
	27	TMSR 20-16	TM2I 16-2.0ISO	43.0	20.0	
	28-32	TMSRL 25-16	TM2I 16-2.0ISO	25.0	22.0	
	39-42	TMSR 25-27	TM2I 27-2.0ISO	52.0	30.0	
	45-48	TMSR 32-27	TM2I 27-2.0ISO	58.0	37.0	
3.0	42-48	TMSR 25-27	TM2I 27-3.0ISO	52.0	30.0	1.73
	50-52	TMSR 32-27	TM2I 27-3.0ISO	58.0	37.0	
	45-52	TMSR 25-27	TM2I 27-4.0ISO	52.0	30.0	
4.0	55	TMSR 32-38	TM2I 38-4.0ISO	55.0	35.0	2.31
	56-58	TMSR 32-27	TM2I 27-4.0ISO	58.0	37.0	
	60-65	TMSR 40-38	TM2I 38-4.0ISO	65.0	46.0	
	48-52	TMSR 32-38	TM2I 38-5.0ISO	55.0	35.0	
5.0	48-52	TMSR 32-38	TM2I 38-5.0ISO	55.0	35.0	2.89
5.5	56	TMSR 32-38	TM2I 38-5.5ISO	55.0	35.0	3.17
	60	TMSR 40-38	TM2I 38-5.5ISO	65.0	46.0	
6.0	64-68	TMSR 40-38	TM2I 38-6.0ISO	65.0	46.0	3.46

* The recommended holder is the largest for the given thread specification
 * Holder with smaller or equal cutting diameters (D2) can also be used

Tooling recommendation for given internal thread specification



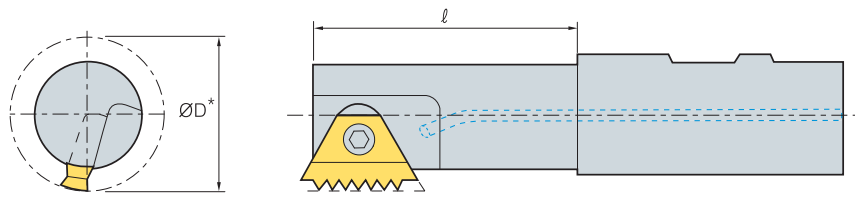
UN

Pitch (tpi)	Nominal dia. (inch)	Holder	Insert	ℓ-Tool holder overhang	D-Tool cutting dia.*	Min.Thread depth (Profile depth)
32	7/16-1/2	TMSR 12-10	TMI 10-32UN	12.0	9.0	0.46
	9/16-11/16	TMSR 12-11	TM2I 11-32UN	12.0	11.5	
	3/4-13/16	TMSR 16-16	TM2I 16-32UN	22.0	17.0	
	7/8-15/16	TMSR 20-16	TM2I 16-32UN	43.0	20.0	
28	1	TMSR 25-16	TM2I 16-32UN	25.0	22.0	0.52
	7/16-1/2	TMSR 12-10	TMI 10-28UN	12.0	9.0	
	9/16-3/4	TMSR 12-11	TM2I 11-28UN	12.0	11.5	
	13/16-7/8	TMSR 16-16	TM2I 16-28UN	22.0	17.0	
	15/16	TMSR 20-16	TM2I 16-28UN	43.0	20.0	
24	1-1 1/8	TMSRL 25-16	TM2I 16-28UN	25.0	22.0	0.61
	9/16-11/16	TMSR 12-11	TM2I 11-24UN	12.0	11.5	
20	1/2-9/16	TMSR 12-10	TMI 10-20UN	12.0	9.0	0.73
	5/8-13/16	TMSR 12-11	TM2I 11-20UN	12.0	11.5	
	7/8	TMSR 16-16	TM2I 16-20UN	22.0	17.0	
	15/16-1	TMSR 20-16	TM2I 16-20UN	43.0	20.0	
	1 1/16-1 1/8	TMSRL 25-16	TM2I 16-20UN	25.0	22.0	
	1 3/8-1 5/8	TMSR 25-27	TM2I 27-20UN	52.0	30.0	
18	1 11/16-1 13/16	TMSR 32-27	TM2I 27-20UN	28.0	37.0	0.81
	5/8	TMSR 12-11	TM2I 11-18UN	12.0	11.5	
	1 1/16-1 3/16	TMSRL 25-16	TM2I 16-18UN	25.0	22.0	
	1 7/16-1 5/8	TMSR 25-27	TM2I 27-18UN	52.0	30.0	
16	1 11/16	TMSR 32-27	TM2I 27-18UN	58.0	37.0	0.92
	11/16-13/16	TMSR 12-11	TM2I 11-16UN	12.0	11.5	
	7/8-15/16	TMSR 16-16	TM2I 16-16UN	22.0	17.0	
	1	TMSR 20-16	TM2I 16-16UN	43.0	20.0	
	1 1/16-1 3/16	TMSRL 25-16	TM2I 16-16UN	25.0	22.0	
	1 7/16-1 5/8	TMSR 25-27	TM2I 27-16UN	52.0	30.0	
14	1 11/16-1 7/8	TMSR 32-27	TM2I 27-16UN	58.0	37.0	1.05
	7/8	TMSR 12-11	TM2I 11-14UN	12.0	11.5	
12	7/8	TMSRT 16-16	TM2I 16-12UN	22.0	15.5	1.22
	15/16	TMSR 16-16	TM2I 16-12UN	22.0	17.0	
	1	TMSR 20-22	TM2I 22-12UN	29.0	19.0	
	1 1/16	TMSR 20-16	TM2I 16-12UN	43.0	20.0	
	1 1/8-1 1/4	TMSRL 25-16	TM2I 16-12UN	25.0	22.0	
	1 1/2-1 11/16	TMSR 25-27	TM2I 27-12UN	52.0	30.0	
	1 3/4-1 15/16	TMSR 32-27	TM2I 27-12UN	58.0	37.0	
8	1 11/16-1 15/16	TMSR 25-27	TM2I 27-8UN	52.0	30.0	1.83
	2-1 1/8	TMSR 32-27	TM2I 27-8UN	58.0	37.0	
6	2-2 1/8	TMSR 25-27	TM2I 27-6UN	52.0	30.0	2.44
	2 1/4	TMSR 32-27	TM2I 27-6UN	58.0	37.0	
	2 3/8-2 1/2	TMSR 40-38	TM2I 38-6UN	65.0	46.0	
4.5	2-2 1/4	TMSR 32-38	TM2I 38-4.5UN	55.0	35.0	3.26
4	2 1/2	TMSR 40-38	TM2I 38-4UN	65.0	46.0	3.67

• The recommended holder is the largest for the given thread specification
 * Holder with smaller or equal cutting diameters (D2) can also be used

D Technical Information for Thread Milling

Tooling recommendation for given internal thread specification



UNJ

Pitch (tpi)	Nominal dia. (inch)	Holder	Insert	ℓ-Tool holder overhang	D-Tool cutting dia.*	Min.Thread depth (Profile depth)
24	9/16-11/16	TMSR 12-11	TM2I 11-24UNJ	12.0	11.5	0.55
20	1/2	TMSR 12-10	TMI 10-20UNJ	12.0	9.0	0.66
	3/4-13/16	TMSR 12-11	TM2I 11-20UNJ	12.0	11.5	
	7/8	TMSR 16-16	TM2I 16-20UNJ	22.0	17.0	
	15/16-1	TMSR 20-16	TM2I 16-20UNJ	43.0	20.0	
18	5/8	TMSR 12-11	TM2I 11-18UNJ	12.0	11.5	0.74
	1 1/16-1 3/16	TMSRL 25-16	TM2I 16-18UNJ	25.0	22.0	
16	11/16-13/16	TMSR 12-11	TM2I 11-16UNJ	12.0	11.5	0.83
	7/8-15/16	TMSR 16-16	TM2I 16-16UNJ	22.0	17.0	
	1	TMSR 20-16	TM2I 16-16UNJ	43.0	20.0	
	1 1/16-1 3/16	TMSRL 25-16	TM2I 16-16UNJ	25.0	22.0	
	1 7/16-1 5/8	TMSR 25-27	TM2I 27-16UNJ	52.0	30.0	
	1 11/16-1 7/8	TMSR 32-27	TM2I 27-16UNJ	58.0	37.0	
14	7/8	TMSR 12-11	TM2I 11-14UNJ	12.0	11.5	0.95
12	7/8	TMSRT 16-16	TM2I 16-12UNJ	22.0	15.5	1.11
	15/16-1	TMSR 16-16	TM2I 16-12UNJ	22.0	17.0	
	1 1/16	TMSR 20-16	TM2I 16-12UNJ	43.0	20.0	
	1 1/8-1 1/4	TMSRL 25-16	TM2I 16-12UNJ	25.0	22.0	
	1 1/2-1 11/16	TMSR 25-27	TM2I 27-12UNJ	52.0	30.0	
	1 3/4-1 15/16	TMSR 32-27	TM2I 27-12UNJ	58.0	37.0	

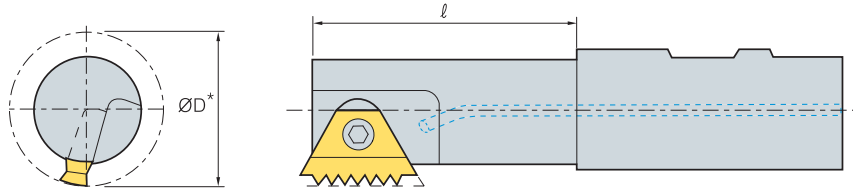
W

Pitch (tpi)	Nominal dia. (inch)	Holder	Insert	ℓ-Tool holder overhang	D-Tool cutting dia.*	Min.Thread depth (Profile depth)
26	1/2-9/16	TMSR 12-10	TMEI 10-26W	12.0	9.0	0.63
	5/8-3/4	TMSR 12-11	TM2EI 11-26 W	12.0	11.5	
	13/16-7/8	TMSR 16-16	TM2EI 16-26W	22.0	17.0	
	15/16-1	TMSR 20-16	TM2EI 16-26W	43.0	20.0	
20	1 1/16-1 1/8	TMSRL 25-16	TM2EI 16-26W	25.0	22.0	0.81
	9/16	TMSR 12-10	TM2EI 10-20W	12.0	9.0	
	5/8-13/16	TMSR 12-11	TM2EI 11-20W	12.0	11.5	
	7/8-15/16	TMSR 16-16	TM2EI 16-20W	22.0	17.0	
16	1	TMSR 20-16	TM2EI 16-20W	43.0	20.0	1.02
	1 1/16-1 3/16	TMSRL 25-16	TM2EI 16-20W	25.0	22.0	
	13/16	TMSR 16-16	TM2EI 16-16W	22.0	15.5	
	7/8-15/16	TMSR 16-16	TM2EI 16-16W	22.0	17.0	
	1-1 1/16	TMSR 20-16	TM2EI 16-16W	43.0	20.0	
	1 1/8-1 1/4	TMSRL 25-16	TM2EI 16-16W	25.0	22.0	
12	1.4-1 5/8	TMSR 25-27	TM2EI 27-16W	52.0	30.0	1.36
	1 3/4-1.9	TMSR 32-27	TM2EI 27-16W	28.0	37.0	
8	1 1/2-1 3/4	TMSR 25-27	TM2EI 27-12W	52.0	30.0	2.03
	1 7/8-1.9	TMSR 32-27	TM2EI 27-12W	58.0	37.0	
7	2.1-2 1/8	TMSR 25-27	TM2EI 27-8W	52.0	30.0	2.32
	2	TMSR 32-27	TM2EI 27-8W	58.0	37.0	
6	2.1-2 1/8	TMSR 25-27	TM2EI 27-7W	52.0	30.0	2.71
	2 1/4	TMSR 25-27	TM2EI 27-6W	52.0	30.0	
	2 3/8-2.6	TMSR 32-38	TM2EI 38-6W	55.0	35.0	
	2 5/8-2 3/4	TMSR 32-27	TM2EI 27-6W	58.0	37.0	
5	3	TMSR 40-38	TM2EI 38-6W	65.0	46.0	3.25
4.5	3 1/2	TMSR 40-38	TM2EI 38-4.5W	65.0	46.0	3.61

* The recommended holder is the largest for the given thread specification
 * Holder with smaller or equal cutting diameters (D2) can also be used



Tooling recommendation for given internal thread specification



BSPT

Pitch (tpi)	Nominal dia. (inch)	Holder	Insert	Ø-Tool holder overhang	D-Tool cutting dia.*	Min.Thread depth (Profile depth)
19	3/8	TMSR 21-11	TM2EI 11-19 BSPT	20.0	11.5	0.86
14	1/2-3/4	TMSRT 16-11	TM2EI 16-14 BSPT	22.0	15.5	1.16
11	1-1 1/4	TMSRT 20-16	TM2EI 16-11 BSPT	23.0	19.0	1.48
	1 1/2	TMSR 25-27	TM2EI 27-11 BSPT	52.0	30.0	
	2-6	TMSRT 32-27	TM2EI 27-11 BSPT	58.0	37.0	

NPT

Pitch (tpi)	Nominal dia. (inch)	Holder	Insert	Ø-Tool holder overhang	D-Tool cutting dia.*	Min.Thread depth (Profile depth)
14	1/2	TMSRT 16-16	TM2EI 16-14 NPT	22.0	15.5	1.33
	3/4	TMSRT 20-16	TM2EI 16-14 NPT	23.0	19.0	
11.5	1	TMSRT 20-16	TM2EI 16-11.5 NPT	23.0	19.0	1.64
	1 1/4	TMSR 25-27	TM2EI 27-11.5 NPT	52.0	30.0	
	1 1/2-2	TMSRT 32-27	TM2EI 27-11.5 NPT	58.0	37.0	
8	2 1/2	TMSRT 32-27	TM2EI 27-8 NPT	58.0	37.0	2.42
	3-24	TMSR 40-38	TM2EI 38-8 NPT	65.0	46.0	

NPTF

Pitch (tpi)	Nominal dia. (inch)	Holder	Insert	Ø-Tool holder overhang	D-Tool cutting dia.*	Min.Thread depth (Profile depth)
14	1/2	TMSRT 16-16	TM2EI 16-14 NPTF	22.0	15.5	1.35
	3/4	TMSRT 20-16	TM2EI 16-14 NPTF	23.0	19.0	
11.5	1	TMSRT 20-16	TM2EI 16-11.5 NPTF	23.0	19.0	1.63
	1 1/2	TMSR 25-27	TM2EI 27-11.5 NPTF	52.0	30.0	
	2	TMSRT 32-27	TM2EI 27-11.5 NPTF	58.0	37.0	
8	2 1/2	TMSRT 32-27	TM2EI 27-8 NPTF	58.0	37.0	2.38
	3	TMSR 40-38	TM2EI 38-8 NPTF	65.0	46.0	

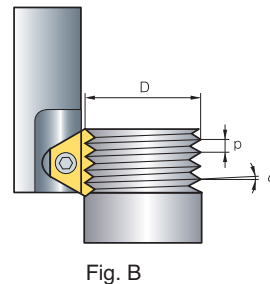
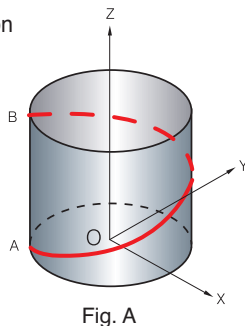
* The recommended holder is the largest for the given thread specification
 * Holder with smaller or equal cutting diameters (D2) can also be used

Minimum bore diameters for thread milling

Pitch	mm	0.5	0.6	0.7	0.75 0.80	0.9	1.0	1.25	1.5	1.75	2.0	-	2.5	3.0	3.5	4.0	4.5	5.0	5.5	-	6.0	-	
	tpi	48	44	36	32	28	26 24	20 19	18 16	14	13 12	11.5 11	10	9 8	7	6	-	5	-	4.5	-	4	
Holder designation	diameter	Minimum diameter for machining																					
TMSR 12-10	9.0	9.5	9.7	9.9	10.0	10.4	10.7	11.4	12.0														
TMSR 20-10	9.0	9.5	9.7	9.9	10.0	10.4	10.7	11.4	12.0														
TMSR 12-11	11.5	12.0	12.2	12.4	12.5	12.9	13.2	13.9	14.5	15.1													
TMSR 20-11	11.5	12.0	12.2	12.4	12.5	12.9	13.2	13.9	14.5	15.1													
TMSRL 25-11	11.5	12.0	12.2	12.4	12.5	12.9	13.2	13.9	14.5	15.1													
TMSRT 16-16	15.5	16.0	16.2	16.4	16.5	16.9	17.2	17.9	18.5	19.0	19.5	20.0											
TMSR 16-16	17.0	17.6	17.8	18.0	18.2	18.7	19.0	19.6	20.0	20.5	21.0	21.5											
TMSR 16-22	17.0	17.6	17.8	18.0	18.2	18.7	19.0	19.6	20.0	20.5	21.0	21.5											
TMSR 20-22	19.0	19.7	20.0	20.2	20.4	20.8	21.0	21.6	22.0	22.5	23.0	23.5											
TMSRT 20-16	19.0	19.7	20.0	20.2	20.4	20.8	21.0	21.6	22.0	22.5	23.0	23.5											
TMSR 20-16	20.0	20.7	21.0	21.2	21.4	21.8	22.0	22.6	23.0	23.5	24.0	24.5											
TMSRW 25-22	22.0	22.7	23.0	23.2	23.4	23.8	24.0	24.6	25.0	25.5	26.0	26.5											
TMSRL 25-22	22.0	22.7	23.0	23.2	23.4	23.8	24.0	24.6	25.0	25.5	26.0	26.5											
TMSRL 25-16	22.0	22.7	23.0	23.2	23.4	23.8	24.0	24.6	25.0	25.5	26.0	26.5											
TMSR 25-27	30.0	30.7	31.0	31.2	31.4	31.8	32.0	32.8	33.5	34.1	34.6	35.6	36.6	39.0	42.0	45.0	48.0						
TMSRL 25-27	30.0	30.7	31.0	31.2	31.4	31.8	32.0	32.8	33.5	34.1	34.6	35.6	36.6	39.0	42.0	45.0	48.0						
TMSR 32-38	35.0								38.5	39.1	39.6	40.6	42.0	44.0	47.0	50.0	53.4	42.5	50.0	44.6	57.5	56.6	
TMSR 32-27	37.0	38.0	38.2	38.4	38.6	39.1	39.5	40.4	41.0	41.5	42.0	43.0	44.0	46.5	49.0	52.0	55.5						
TMSRL 32-27	37.0	38.0	38.2	38.4	38.6	39.1	39.5	40.4	41.0	41.5	42.0	43.0	44.0	46.5	49.0	52.0	55.5						
TMSRT 32-27	37.0	38.0	38.2	38.4	38.6	39.1	39.5	40.0	41.0	41.5	42.0	43.0	44.0	46.5	49.0	52.0	55.5						
TMSR 40-38	46.0								49.5	50.1	50.6	51.6	53.0	55.0	55.2	55.6	55.0	52.5	54.0	54.5	57.5	56.6	
TMSRL 40-38	46.0								49.5	50.1	50.6	51.6	53.0	55.0	55.2	55.6	55.0	52.5	54.0	54.5	57.5	56.6	

- In order to perform a thread milling operation, a milling machine with three-axis control capability of helical interpolation is required
- Helical interpolation is a CNC function producing tool movement along a helical path. This helical motion combines circular movement in one plane with a simultaneous linear motion in a plane perpendicular to the first. For example, the path from point A to point B (Fig.A) on the envelope of the cylinder combines a circular movement in the x-y plane with a linear displacement in the z direction
- On most CNC systems this function can be executed in two different ways:

- G02: Helical interpolation in a clockwise direction
- G03: Helical interpolation in a counter-clockwise direction



- The thread milling operation (Fig. B) consists of circular rotation of the tool around its own axis together with an orbiting motion along the bore or workpiece circumference. During one such orbit, the tool will shift vertically one pitch length. These movements combined with the insert geometry create the required thread form. There are three acceptable ways of approaching the workpiece with the tool to initiate production of the thread:

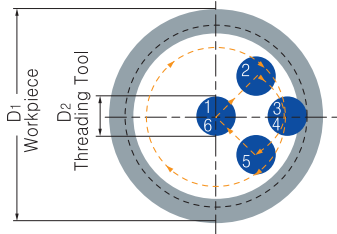
1. Tangential Arc Approach
2. Radial Approach
3. Tangential Line Approach



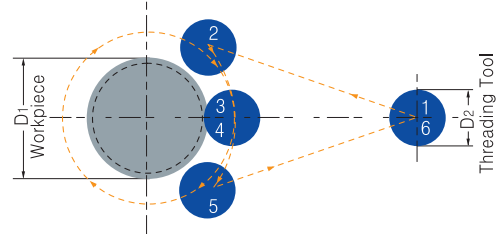
Tangential arc approach

- With this method, the tool enters and exits the workpiece smoothly. No marks are left on the workpiece and there is no vibration, even with harder materials. Although it requires slightly more complex programming than the radial approach (see below), this is the method recommended for machining the highest quality threads

Internal thread



External thread

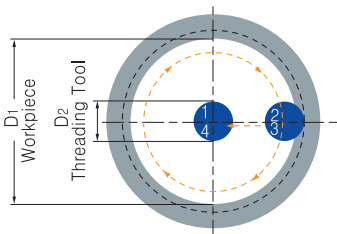


- 1-2: rapid approach
- 2-3: tool entry along tangential arc, with simultaneous feed along z-axis
- 3-4: helical movement during one full orbit (360°)
- 4-5: tool exit along tangential arc, with continuing feed along z-axis
- 5-6: rapid return

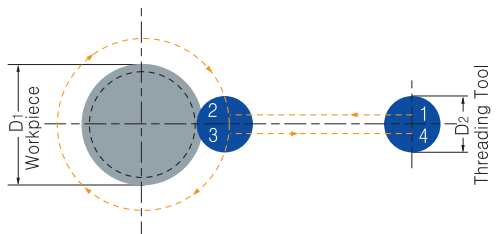
Radial approach

- This is the simplest method. There are two characteristics worth noting about the radial approach:
 - A. a small vertical mark may be left at the entry (and exit) point. This is of no significance to the thread itself
 - B. when using this method with very hard materials, there may be a tendency of the tool to vibrate as it approaches the full cutting depth
- Note: Radial feed during entry to the full profile depth should only be 1/3 of the subsequent circular feed

Internal thread



External thread

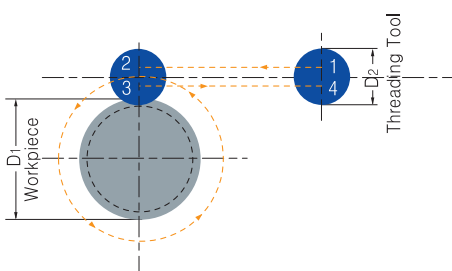


- 1-2: radial entry
- 2-3: helical movement during one full orbit (360°)
- 3-4: radial exit

Tangential line approach

- This method is very simple, and has all of the advantages of the tangential arc method. However, it is applicable only with external threads

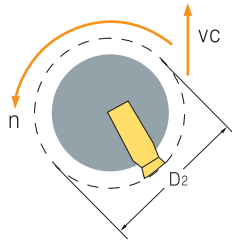
External thread



- 1-2: radial entry with simultaneous feed along z axis
- 2-3: helical movement during one full orbit (360°)
- 3-4: radial exit

Preparing for the thread milling operation

➤ Calculation of rotational velocity and feed at the cutting edge



$$n = \frac{vc \times 1000}{\pi \times D2}$$

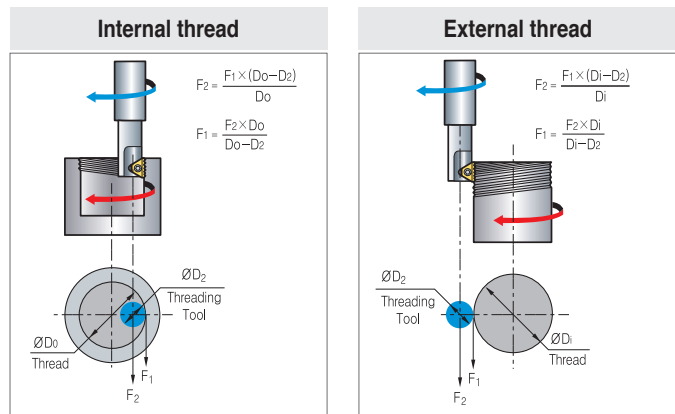
$$vc = \frac{n \times \pi \times D2}{1000}$$

$$F1 = n \times z \times fn$$

- n:** Rotational Velocity (min⁻¹)
- vc:** Cutting Speed (m/min)
- D2:** Tool holder Cutting Dia. (mm)
- F1:** Real Feed rate at the Cutting edges (mm/min)
- z:** No. of Cutting Edges
- fn:** Feed per Root per Rotation (mm/rev)

➤ Calculation of feed rates at the tool center line

- On most CNC machines, the feed rate required for programming is that of the center-line of the tool. When dealing with linear tool movement, the feed rate at the cutting edge and the center line are identical, but with circular tool movement this is not the case. The equations define the relationship between feed rates at the cutting edge and at the tool center line.



➤ Grades and applications

- Grade: PC9570T
- Application: First Choice for steel and cast iron. A tough sub-micron substrate with TiCN coating. Provides good fracture toughness and excellent wear resistance.

➤ Trouble shooting

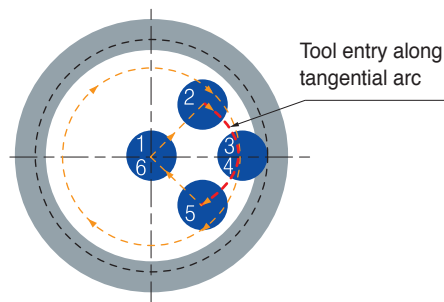
Problem	Possible	Solution
Increased insert flank wear	Cutting speed too high> Chip is too thin> Insufficient coolant>	Reduce cutting speed/use coated insert Increase feed rate Increase coolant flow rate
Chipping of cutting edge	Chip is too thick> Vibration>	Reduce feed rate/Use the tangential arc method Increase RPM Check stability
Material built-up on the cutting edge	Incorrect cutting speed> Unsuitable carbide grade>	Change cutting speed Use a coated carbide grade
Chatter/vibration	Feed rate is too high> Profile is too deep> Thread length is too long>	Reduce the feed. Execute two passes, each with increased cutting depth/ Execute two passes, each cutting only half the thread length Execute two passes, each cutting only half the thread length
Insufficient thread accuracy	Tool deflection>	Reduce feed rate/Execute a "zero" cut

Recommended cutting condition

	Workpiece	Hardness brinell (HB)	vc (m/min)		Feed fz (mm/t)		
			Grade		Indexable insert	Solid endmill	
			PC9570T	PC9070M			
P	Unalloyed steel	Low carbon (C+0.1-0.25%)	125	100~210	80~250	0.05~0.3	0.03~0.15
		Medium carbon (C = 0.25-0.55%)	150	100~180	80~230	0.05~0.25	0.03~0.1
		High carbon (C = 0.55-0.85%)	170	100~170	80~200	0.05~0.2	0.03~0.08
	Low alloy steel	Non-hardened	180	90~160	60~180	0.05~0.25	0.03~0.1
		Hardened	275	80~150	60~170	0.05~0.2	0.03~0.07
		Hardened	350	70~140	60~160	0.05~0.15	0.01~0.03
	High alloy steel	Annealed	200	60~130	40~100	0.05~0.2	0.03~0.05
		Hardened	325	70~110	30~80	0.05~0.1	0.01~0.03
	Cast steel	Low alloy	200	100~170	80~250	0.05~0.15	0.03~0.1
		High alloy	225	70~120	60~170	0.05~0.1	0.01~0.03
M	Stainless steel ferritic	Non-hardened	200	100~170	60~150	0.05~0.15	0.04~0.1
		Hardened	330	100~170	60~120	0.05~0.1	0.01~0.05
	Stainless steel Austenitic	Austenitic	180	70~140	60~140	0.05~0.15	0.04~0.1
		Super austenitic	200	70~140	60~130	0.05~0.1	0.04~0.1
	Stainless steel cast ferritic	Non-hardened	200	70~140	60~160	0.05~0.15	0.04~0.1
		Hardened	330	70~140	60~110	0.05~0.1	0.03~0.05
	Stainless steel cast austenitic	Austenitic	200	70~120	60~150	0.05~0.15	0.04~0.1
		Hardened	330	70~120	60~100	0.05~0.1	0.03~0.05
	High temperature alloys	Annealed (Iron based)	200	20~45	30~60	0.05~0.1	0.04~0.1
		Aged (Iron based)	280	20~30	20~50	0.02~0.05	0.01~0.03
		Annealed (Nickel or Cobalt based)	250	15~20	15~35	0.02~0.05	0.01~0.03
		Aged (Nickel or Cobalt based)	350	10~15	15~30	0.02~0.05	0.01~0.03
	Titanium alloys	Pure 99.5 Ti	400Rm	70~140	40~80	0.02~0.05	0.03~0.05
		α+β alloys	1050Rm	20~50	20~50	0.02~0.05	0.03~0.05
K	Extra hard steel	Hardened & tempered	55HrC	20~45	15~45	0.01~0.03	0.005~0.01
	Malleable cast iron	Ferritic (short chips)	130	60~130	70~160	0.02~0.08	0.01~0.03
		Pearlitic (long chips)	230	60~120	60~150	0.02~0.05	0.03~0.05
	Grey cast iron	Low tensile strength	180	60~130	70~160	0.05~0.15	0.05~0.1
		High tensile strength	260	60~100	40~120	0.05~0.1	0.03~0.05
	Nodular SG iron	Ferritic	160	60~125	40~110	0.05~0.15	0.05~0.1
		Pearlitic	260	50~90	40~100	0.05~0.1	0.03~0.05
	N	Aluminum alloys Wrought	Non-aging	60	100~250	200~300	0.1~0.4
Aged			100	100~180	150~250	0.1~0.3	0.1~0.2
Aluminum alloys		Cast	75	150~400	100~200	0.1~0.3	0.1~0.2
		Cast & aged	90	150~280	120~220	0.05~0.25	0.1~0.15
		Cast Si 13-22%	130	80~150	200~300	0.1~0.3	0.1~0.2
Copper and copper alloys		Brass	90	120~210	200~300	0.1~0.3	0.1~0.25
		Bronze and non-leaded copper	100	120~210	150~250	0.05~0.25	0.1~0.2

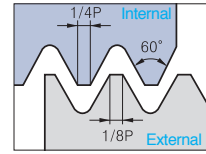
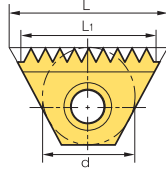
Example

- At tool entry, set the Feed fz (mm/tooth) to 70% lower than the threading Feed
- Threading Feed: 0.3 (mm/t)
- Tool entry Feed: 0.09 (mm/t)



D Thread Milling Inserts

ISO Metric



Defined by: R262 (DIN 13)
Tolerance class: 6g/6H

(mm)

External/Internal

Insert size		Pitch (mm)	Designation				L1	Tooth	Tool holder	
d	L		External	PC9570T	Internal	PC9570T				
6.0	10.4	0.5	-		TMI	10-0.5ISO	●	10.0	TMSR - 10	
		0.75	-			10-0.75ISO		9.75		
		1.0	-			10-1.0ISO	●	9.0		
		1.25	-			10-1.25ISO		8.75		
		1.5	-			10-1.5ISO		9.0		
6.35	11	0.5	-		TM2I	11-0.5ISO		10.0	TMSR - 11	
		0.75	TM2E	11-0.75ISO			●	10.5		
		1.0		11-1.0ISO			●	10.0		
		1.25		11-1.25ISO			-	10.0		
		1.25		-			11-1.25ISO			8.75
		1.5		11-1.5ISO			-	9.0		
		1.5		-			11-1.5ISO	●		10.5
9.525	16	0.5	-		TM2I	16-0.5ISO		15.0	TMSR - 16	
		0.75	TM2E	16-0.75ISO				15.0		
		0.8		-				14.4		
		1.0		16-1.0ISO			-	14.0		
		1.0		-			16-1.0ISO	●		15.0
		1.25		16-1.25ISO			16-1.25ISO			15.0
		1.5		16-1.5ISO	●		16-1.5ISO	●		15.0
		1.75		16-1.75ISO			16-1.75ISO			14.0
2.0		16-2.0ISO			16-2.0ISO	●	14.0			
9.525B	22	1.0	TM2E	22-1.0ISO		TM2I	22-1.0ISO		22.0	
		1.25		22-1.25ISO				21.25		
		1.5		22-1.5ISO			●	21.0		
		1.75		22-1.75ISO				21.0		
		2.0		22-2.0ISO	●		22-2.0ISO	●	22.0	
15.875	27	1.0	TM2E	27-1.0ISO		TM2I	27-1.0ISO		26.0	
		1.25		27-1.25ISO				25.0		
		1.5		27-1.5ISO			●	25.5		
		1.75		27-1.75ISO				24.5		
		2.0		27-2.0ISO			●	24.0		
		2.5		27-2.5ISO			●	25.0		
		3.0		27-3.0ISO			●	24.0		
		3.5		27-3.5ISO				24.5		
		4.0		27-4.0ISO			●	24.0		
		4.5		27-4.5ISO				22.5		
19.05B	38.5	1.5	TM2E	38-1.5ISO		TM2I	38-1.5ISO		36.0	
		2.0		38-2.0ISO				36.0		
		3.0		38-3.0ISO				36.0		
		4.0		38-4.0ISO				32.0		
		4.5		38-4.5ISO				31.5		
		5.0		38-5.0ISO				30.0		
		5.5		38-5.5ISO				33.0		
		6.0		38-6.0ISO				30.0		

➔ Applicable holders **D49**

All inserts except TMI10 code have 2 cutting edges

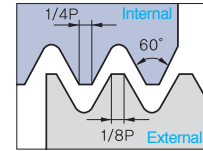
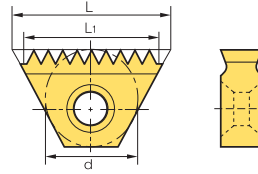
●: Stock item



D

Threading

American UNC



Defined by: ANSI B1.1.74
Tolerance class: Class 2A/2B

(mm)

External/Internal

Insert size		Pitch (tpi)	Designation				L1	Tooth	Tool holder		
d	L		External	PC9570T	Internal	PC9570T					
6.0	10.4	32	-		TMI	10-32UN		9.53	12	TMSR - 10	
		28	-			10-28UN		9.07	10		
		24	-			10-24UN		9.53	9		
		20	-			10-20UN	●	8.89	7		
		18	-			10-18UN		8.47	6		
		16	-			10-16UN		7.94	5		
6.35	11	48	-		TM2I	11-48UN		10.05	19	TMSR - 11	
		40	-			11-40UN		10.16	16		
		32	-			11-32UN		10.32	13		
		28	TM2E	11-28UN			11-28UN		9.98		11
		27		11-27UN			11-27UN		10.35		11
		24		11-24UN			11-24UN		9.53		9
		20		11-20UN			11-20UN		10.16		8
		18		11-18UN			11-18UN	●	9.88		7
		16		11-16UN			11-16UN		9.53		6
14		11-14UN			11-14UN		9.07	5			
9.525	16	40	-		TM2I	16-40UN		14.61	40	TMSR - 16	
		32	-			16-32UN		15.08	32		
		28	TM2E	16-28UN			16-28UN		14.51		28
		27		16-27UN			16-27UN		14.11		27
		24		16-24UN			16-24UN		14.82		24
		20		16-20UN			16-20UN		13.97		20
		18		16-18UN			16-18UN		14.11		18
		16		16-16UN			16-16UN	●	14.29		16
		14		16-14UN			16-14UN		14.51		14
		13		16-13UN			16-13UN		13.68		13
		12		16-12UN			16-12UN	●	14.82		12
11.5		16-11.5UN			16-11.5UN		13.25	11.5			
9.525B	22	24	TM2E	22-24UN		TM2I	22-24UN		21.16	20	TMSR - 22
		20		22-20UN			22-20UN		21.59	17	
		18		22-18UN			22-18UN		21.17	15	
		16		22-16UN			22-16UN		20.64	13	
		14		22-14UN			22-14UN		21.77	12	
		13		22-13UN			22-13UN		21.49	11	
		12		22-12UN			22-12UN		21.17	10	
		11.5		22-11.5UN			22-11.5UN		24.30	11	
15.875	27	24	TM2E	27-24UN		TM2I	27-24UN		25.40	24	TMSR - 27
		20		27-20UN			27-20UN		25.40	20	
		18		27-18UN			27-18UN		25.40	18	
		16		27-16UN			27-16UN		25.40	16	
		14		27-14UN			27-14UN		25.40	14	
		13		27-13UN			27-13UN		25.40	13	
		12		27-12UN			27-12UN		25.40	12	
		11.5		27-11.5UN			27-11.5UN		24.30	11	
		11		27-11UN			27-11UN		25.40	11	
		10		27-10UN			27-10UN		22.86	9	
		10		-			27-10UN		25.40	10	
		9		27-9UN			27-9UN		22.58	8	
		8		27-8UN			27-8UN		22.23	7	
		7		27-7UN			-		21.77	6	
		7		-			27-7UN		25.40	7	
6		27-6UN			-		21.17	5			
6		-			27-6UN		25.40	6			
19.05	38.5	6	TM2E	38-6UN		TM2I	38-6UN		38.87	8	TMSR - 38
		5		38-5UN			38-5UN		30.48	6	
		4.5		38-4.5UN			38-4.5UN		33.87	6	
		4		38-4UN			38-4UN		31.75	5	

Applicable holders **D49**

All inserts except TMI10 code have 2 cutting edges

● : Stock item

Threading

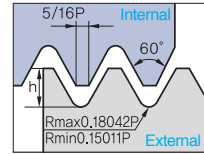
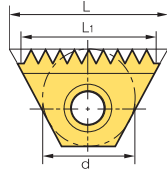


D

D Thread Milling Inserts

UNJ(Unified Constant Thread)

External/Internal



Defined by: MIL-S-8879C
Tolerance class: 3A/3B

(mm)

Insert size		Pitch (tpi)	Designation				L ₁	Tooth	Tool holder	
d	L		External	PC9570T	Internal	PC9570T				
6.0	10.4	24	-		TMI	10-24UNJ	9.53	9	TMSR - 10	
		20	-			10-20UNJ	8.89	7		
		18	-			10-18UNJ	8.47	6		
		16	-			10-16UNJ	9.53	8		
6.35	11	24	TM2E	11-24UNJ		TM2I	11-24UNJ	9.53	9	TMSR - 11
		20		11-20UNJ			11-20UNJ	10.16	8	
		18		-			11-18UNJ	9.88	7	
		16		11-16UNJ			11-16UNJ	9.53	6	
		14		11-14UNJ			11-14UNJ	9.07	5	
9.525	16	24	TM2E	16-24UNJ		TM2I	16-24UNJ	14.82	14	TMSR - 16
		20		16-20UNJ			16-20UNJ	13.97	11	
		18		16-18UNJ			16-18UNJ	14.11	10	
		16		16-16UNJ			16-16UNJ	14.29	9	
		14		16-14UNJ			16-14UNJ	14.51	8	
		13		16-13UNJ			-	13.68	7	
		12		16-12UNJ			16-12UNJ	14.82	7	
15.875	27	16	TM2E	27-16UNJ		TM2I	27-16UNJ	25.40	16	TMSR - 27
		12		27-12UNJ			27-12UNJ	25.40	12	
		11		27-11UNJ			27-11UNJ	25.40	11	

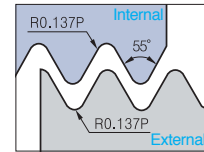
↻ Applicable holders **D49**

All inserts except TMI10 code have 2 cutting edges

●: Stock item

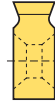
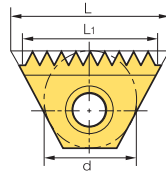


Whitworth (BSW, BSF, BSP, BSB)



BSW Defined by: B.S.84:1956, DIN 259, ISO228/1:1982
 BSP Defined by: B.S.2779:1956
 Tolerance class: BSW-Medium class A, BSP-Medium class

External/Internal



(mm)

Insert size		Pitch (tpi)	Designation		PC9570T	L1	Tooth	Tool holder
d	L		External+Internal					
6.0	10.4	28	TMEI	10-28W		9.07	10	TMSR - 10
		26		10-26W		8.79		
		24		10-24W		9.53		
		20		10-20W		8.89		
		19		10-19W		9.36		
6.35	11	28	TM2EI	11-28W		9.98	11	TMSR - 11
		26		11-26W		9.77		
		24		11-24W		9.53		
		20		11-20W		10.16		
		19		11-19W		9.36		
		14		11-14W		9.07		
9.525	16	26	TM2EI	16-26W		14.65	15	TMSR - 16
		24		16-24W		14.82		
		20		16-20W		13.97		
		19		16-19W		14.71		
		18		16-18W		14.11		
		16		16-16W		14.29		
		14		16-14W		14.51		
		12		16-12W		14.82		
9.525B	22	24	TM2EI	22-24W		21.17	20	TMSR - 22
		20		22-20W		21.59		
		19		22-19W		21.39		
		18		22-18W		21.17		
		16		22-16W		20.64		
		14		22-14W		21.77		
		12		22-12W		21.17		
		11		22-11W		20.78		
15.875	27	16	TM2EI	27-16W		25.4	16	TMSR - 27
		14		27-14W		25.4		
		12		27-12W		23.28		
		11		27-11W		23.09		
		10		27-10W		25.40		
		9		27-9W		22.58		
		8		27-8W		22.23		
		7		27-7W		21.77		
19.05B	38.5	11	TM2EI	38-11W		34.64	15	TMSR - 38
		6		38-6W		33.87		
		5		38-5W		30.48		
		4.5		38-4.5W		33.87		
		-		38-15W		-		

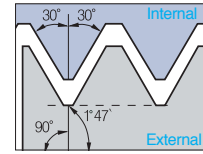
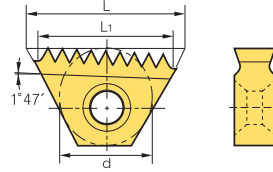
➔ Applicable holders **D49**

All inserts except TMI10 code have 2 cutting edges

● - Stock item

D Thread Milling Inserts

NPT



Defined by: USAS B2.1:1968
Tolerance class: Standard NPT

(mm)

External/Internal

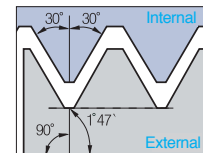
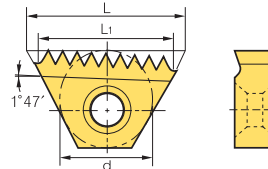
Insert size		Pitch (tpi)	Designation		PC9570T	L ₁	Tooth	Tool holder	
d	L		External+Internal					RH	LH
9.525	16	18	TM2E	16-18NPT *		14.11	10	TMSRT - 16	TMSLT - 16
		14	TM2EI	16-14NPT		14.51	8		
		11.5		16-11.5NPT		13.25	6		
9.525B	22	14	TM2EI	22-14NPT		21.77	12	TMSRT - 22	TMSLT - 22
15.875	27	11.5	TM2EI	27-11.5NPT	●	24.30	11	TMSR - 27	TMSL - 27
		8		27-8NPT	●	22.23	7		
19.05B	38.5	11.5	TM2EI	38-11.5NPT		35.34	16	TMSR - 38	TMSL - 38
		8		38-8NPT		31.75	10		

➔ Applicable holders D49

* TM2E16-18NPT is for external threading

●: Stock item

NPTF



Defined by: ANSI 1.20.3-1976
Tolerance class: Standard NPTF

(mm)

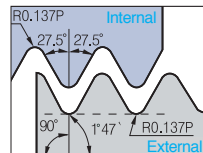
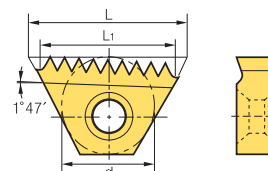
External/Internal

Insert size		Pitch (tpi)	Designation		PC9570T	L ₁	Tooth	Tool holder	
d	L		External+Internal					RH	LH
9.525	16	14	TM2EI	16-14NPTF	●	14.51	8	TMSRT - 16	TMSLT - 16
		11.5		16-11.5NPTF		13.25	6		
9.525B	22	14	TM2EI	22-14NPTF		21.77	12	TMSRT - 22	TMSLT - 22
		11.5		22-11.5NPTF		19.88	9		
15.875	27	11.5	TM2EI	27-11.5NPTF		24.30	11	TMSR - 27	TMSL - 27
		8		27-8NPTF		22.23	7		
19.05B	38.5	11.5	TM2EI	38-11.5NPTF		35.34	16	TMSR - 38	TMSL - 38
		8		38-8NPTF		31.75	10		

➔ Applicable holders D49

●: Stock item

BSPT



Defined by: B.S 21:1985
Tolerance class: Standard BSPT

(mm)

External/Internal

Insert size		Pitch (tpi)	Designation		PC9570T	L ₁	Tooth	Tool holder	
d	L		External+Internal					RH	LH
6.35	11	19	TM2EI	11-19BSPT		9.36	7	TMSR - 10	TMSL - 10
9.525	16	14	TM2EI	16-14BSPT		14.51	8	TMSRT - 16	TMSLT - 16
		11		16-11BSPT		13.85	6		
15.875	27	11	TM2EI	27-11BSPT		23.09	10	TMSR - 27	TMSL - 27

➔ Applicable holders D49

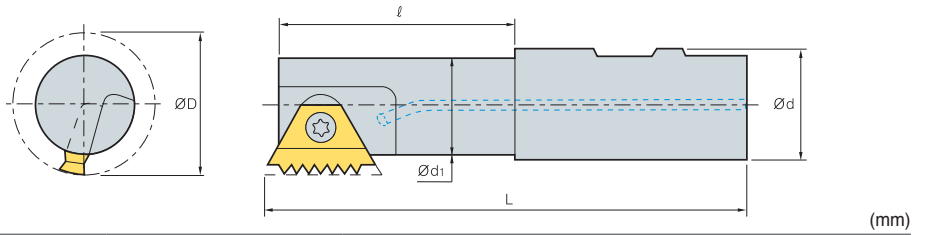
●: Stock item



D

Threading

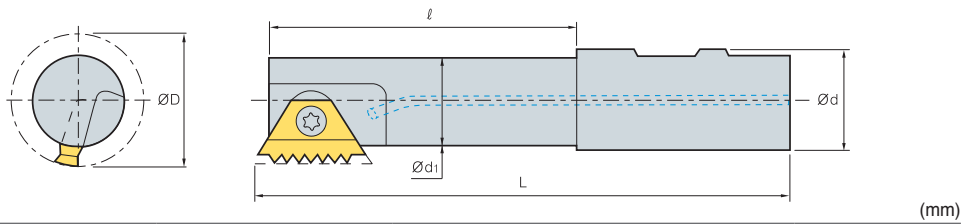
Standard Type



Insert size d	Designation	ØD	Ød	Ød ₁	ℓ	L	Screw	Wrench
6.0	TMSR 12-10	9.0	12	6.8	12.0	69.0	STM10	TW07P
	20-10	9.0	20	6.8	17.0	84.0		
6.35	TMSR 12-11	11.5	12	8.9	12.0	70.0	STM11	TW08P
	20-11	11.5	20	8.9	20.0	85.0		
9.525	TMSR 16-16	17.0	16	13.6	22.0	90.0	STM1622	TW10P
	20-16	20.0	20	16.6	43.0	95.0		
9.525B	TMSR 16-22	17.0	16	13.5	29.0	79.5	STM1622	TW10P
	20-22	19.0	20	15.5	29.0	81.5		
	TMSRW 25-22	22.0	25	18.5	30.0	90.8		
15.875	TMSR 25-27	30.0	25	24.0	52.0	110.0	STM27	TW25L
	TMSL 25-27	30.0	25	24.0	52.0	110.0		
	TMSR 32-27	37.0	32	31.0	58.0	120.0		
19.05	TMSR 32-38	35.0	32	27.0	53.0	115.0	STM38	TW30L
	40-38	46.0	40	38.0	63.0	135.0		

➔ Applicable inserts D44~48

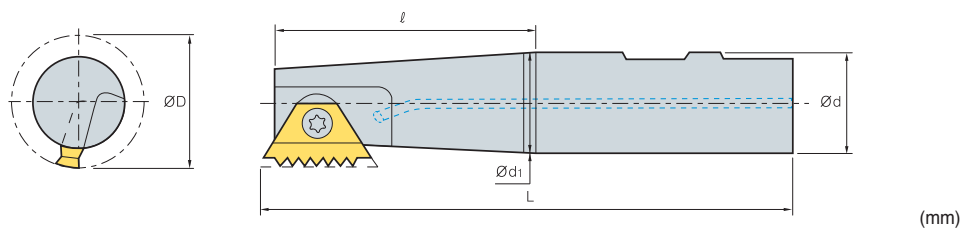
Long Type



Insert size d	Designation	ØD	Ød	Ød ₁	ℓ	L	Screw	Wrench
6.35	TMSRL 25-11	11.5	25	8.9	17.0	125.0	STM11	TW08P
9.525B	TMSRL 25-16	22.0	25	18.6	25.0	125.0	STM1622	TW10P
9.525B	TMSRL 20-22	19.0	20	15.5	44.0	96.5	STM1622	TW10P
	25-22	22.0	25	18.6	63.5	125.0		
15.875	TMSRL 25-27	30.0	25	24.0	92.0	150.0	STM27	TW25L
	32-27	37.0	32	31.0	98.0	160.0		
19.05B	TMSRL 40-38	46.0	40	38.0	93.0	168.0	STM38	TW30L

➔ Applicable inserts D44~48

Tapered Type

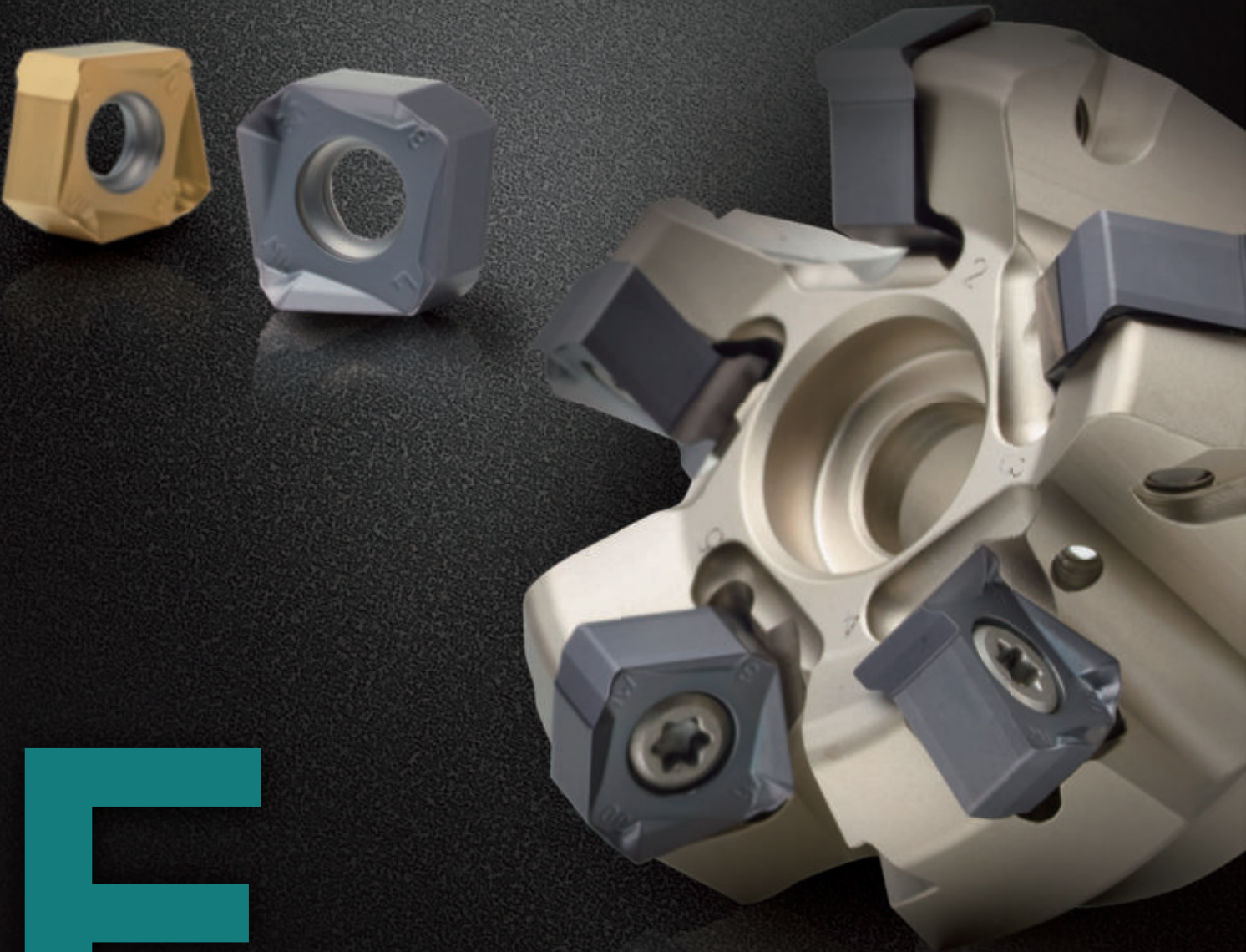


Insert size d	Designation	ØD	Ød	Ød ₁	ℓ	L	Screw	Wrench
9.525	TMSRT 16-16	15.5	16	12.5	22.0	90.0	STM1622	TW10P
	20-16	19.0	20	15.0	23.0	85.0	STMT16	
9.525B	TMSRT 16-22	17.0	16	13.5	29.0	79.5	STM1622	TW10P
	20-22	19.0	20	15.5	29.0	81.5		
15.875	TMSRT 32-27	37.0	32	31.0	58.0	120.0	STM27	TW25L

➔ Applicable inserts D44~48

MILLING

Milling tools that provide the best quality and improve productivity for every customer needs.



E

Insert

- E02** Milling Insert Code System (ISO)
- E04** Milling Inserts
- E34** KORLOY Cutters
- E42** KORLOY Shanks
- E45** KORLOY Modular Adaptors

Face Milling Cutters

- E47** Mill-max/Mill-max Plus (E48, E54)
- E57** Technical Information for Mill-max Heavy
- E58** Mill-max Heavy
- E59** Turbo Mill
- E62** Double Mill
- E64** Technical Information for Power Buster
- E68** Power Buster
- E71** Technical Information for Rich Mill
- E99** Rich Mill
- E147** Technical Information for Aero Mill/Aero Mill-Plus/Aero Mill-Mini
- E151** Aero Mill
- E152** Aero Mill-Plus
- E154** Aero Mill-Mini
- E156** PCD face cutter

Cutters for Molds

- E157** Technical Information for Alpha Mill
- E158** Technical Information for Alpha Mill Nick
- E164** Alpha Mill
- E193** Technical Information for Alpha Mill-X
- E197** Alpha Mill-X
- E201** Technical Information for Future Mill
- E211** Technical Information for Future Mill P-Positive
- E216** Future Mill
- E242** Future Mill P-Positive
- E254** Technical Information for Triple Mill
- E258** Triple Mill

Cutters for Molds

- E262** Technical Information for HFMD
- E267** HFMD
- E277** Technical Information for HFM
- E281** HFM
- E284** Technical Information for HRMDouble
- E289** HRMDouble
- E300** HRM
- E307** Tank Mill
- E308** Technical Information for TP2P
- E311** TP2P
- E317** Technical Information for Laser Mill/GBE/BRE
- E326** Laser Mill
- E331** BFE
- E332** GBE
- E335** BRE
- E337** Technical Information for HAVE
- E339** HAVE (Multi-edge, Single-edge)
- E341** Technical Information for BT/HSK Tooling System
- E342** BT Tooling System (Alpha Mill)
- E347** BT Tooling System (Mono-Tool)
- E353** HSK Tooling System (Alpha Mill)
- E358** HSK Tooling System (Mono-Tool)
- E363** HSK Tooling System (Pro-V Mill)
- E364** O-ring Cutter
- E366** Chamfer Tool (Multi-functional, Solid)
- E374** T-Cutter (TFE)

Milling Cutter for Aluminum

- E375** Technical Information for Pro-A Mill/Pro-X Mill/Pro-L Mill/Pro-XL Mill/Pro-V Mill
- E385** Pro-A Mill
- E388** Pro-X Mill
- E394** Pro-L Mill
- E398** Pro-XL Mill
- E399** Pro-V Mill
- E401** Modular Adaptor (MAT/BT/HSK)

Side Milling Cutters

- E405** Technical Information for Side Milling Cutters
- E407** Side Milling Cutters
- E411** Side Cutter
- E414** Wind Mill

Milling Cutter for Cast iron at high feed

- E418** Technical information for High feed Cutter
- E420** Technical information for Cube Mill
- E421** Technical information for Couple Mill
- E423** Technical information for Shave Mill
- E425** Technical information for Shave Mill Ultra

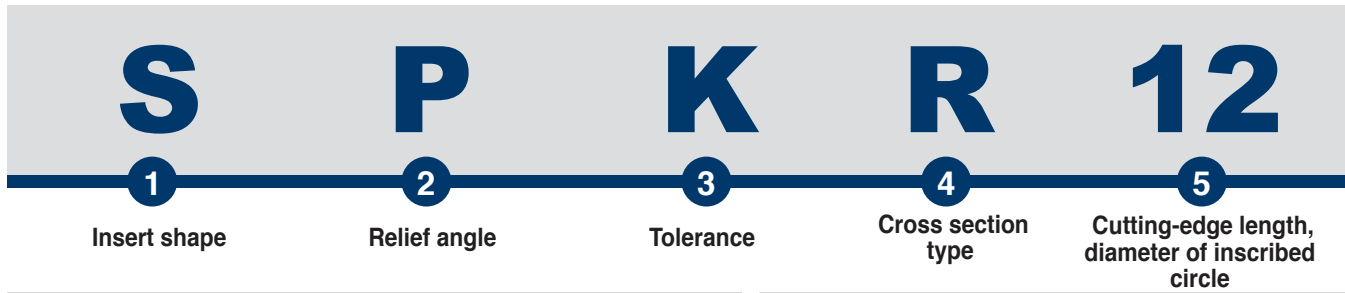
Detail Information of Milling Cutter and Arbor

- E426** Actual Designation of Milling Cutter and Arbor

Gear Tools

- E429** Technical information for Gear Cutter Tools
- E430** Gear Cutter Table
- E431** Gear Cutter
- E439** Gear Cutter Order Form
- E440** Indexable HOB
- E441** Indexable HOB Cutter Order Form

E Milling Insert Code System (ISO)



1 Insert shape

S P K R 12 03 ^{ED}08 S R - MX

A (85°~88°) C (80°) D (55°) H L O
 R S T V (35°) W (80°)

2 Relief angle

S P K R 12 03 ^{ED}08 S R - MX

A (3°) B (5°) C (7°) D (15°) E (20°)
 F (25°) G (30°) N (11°) P

3 Tolerance

S P K R 12 03 ^{ED}08 S R - MX

d: Inscribed circle
t: Thickness
m: Refer to figure

■ Tolerance on C, E, H, M, O, P, R, S, T, W Insert Shape (exceptional case) (mm)
 ■ Tolerance on D Insert Shape (exceptional case)

Class	d	m	t	Tolerance on d		Tolerance on m	
				J, K, L, M, N	U	M, N	U
A	±0.025	±0.005	±0.025	6.35	±0.05 ±0.08	±0.08	±0.13
C	±0.025	±0.013	±0.025	9.525	±0.05 ±0.08	±0.08	±0.13
H	±0.013	±0.013	±0.025	12.7	±0.08 ±0.13	±0.13	±0.20
E	±0.025	±0.025	±0.025	15.875	±0.10 ±0.18	±0.15	±0.27
G	±0.025	±0.025	±0.13	19.05	±0.10 ±0.18	±0.15	±0.27
J	±0.05~±0.15	±0.005	±0.025	25.4	±0.13 ±0.25	±0.18	±0.38
K	±0.05~±0.15	±0.013	±0.025	Tolerance on D Insert Shape (exceptional case)			
L	±0.05~±0.15	±0.025	±0.025	d	Tolerance on d	Tolerance on m	
M	±0.05~±0.15	±0.08~±0.20	±0.13	6.35	±0.05	±0.11	
U	±0.08~±0.25	±0.13~±0.38	±0.13	9.525	±0.05	±0.11	
				12.7	±0.08	±0.15	
				15.875	±0.10	±0.18	
				19.05	±0.10	±0.18	

4 Cross section type

S P K R 12 03 ^{ED}08 S R - MX

A B C F
 C'Sink 70°~90° C'Sink 70°~90°
 G H J M
 C'Sink 70°~90° C'Sink 70°~90°
 N Q R T
 C'Sink 40°~60° C'Sink 40°~60°
 U W X
 C'Sink 40°~60° C'Sink 40°~60°
 Special type

5 Cutting-edge length, diameter of inscribed circle

S P K R 12 03 ^{ED}08 S R - MX

■ Metric system * Decimal integer constant
 ■ Inch system

· Use 1/32" unit for a insert having smaller I.C under 1/4"
 · Use 1/8" unit for a insert having larger I.C over 1/4"

■ In case of rectangular and rhombic insert indicate cutting-edge length instead of inscribed circle.

■ Cross over chart for "Metric" and "Inch" system

Symbol	06	09	11	16	22	27	33	44
△								
○	03	05	06	09	12	15	19	25
55°	04	06	07	11	15	19	23	31
80°	03	05	06	09	12	16	19	25
Inscribed circle	5/32"	7/32"	1/4"	3/8"	1/2"	5/8"	3/4"	1"
Inch system	5	7	2 (8)	3	4	5	6	8



03

**ED
08**

S

R - MX

6

Height of cutting-edge

7

Nose radius (Nose R)

8

Edge preparation

9

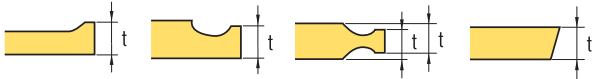
Hand

10

Chip breaker for milling

6 Height of cutting-edge

S P K R 12 03 **ED 08** S R - MX

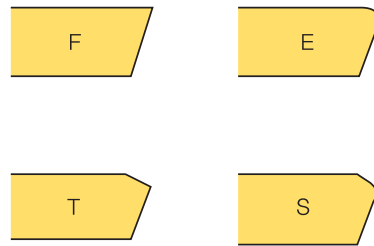


Symbol		Height of cutting-edge (t)	
Metric	Inch	Metric	Inch
01	1 (2)	1.59	1/16
T0	1.125	1.79	9/128
T1	1.2	1.98	5/64
02	1.5 (3)	2.38	3/32
T2	1.75	2.78	7/64
03	2	3.18	1/8
T3	2.5	3.97	5/32
04	3	4.76	3/16
05	3.5	5.56	7/32
06	4	6.35	1/4
07	5	7.94	5/16
09	6	9.52	3/8
11	7	11.11	7/16
12	8 (16)	12.70	1/2

() Symbol for small size insert

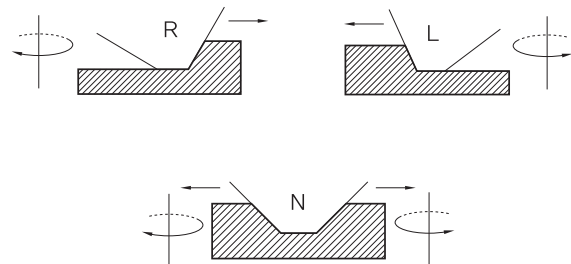
8 Edge preparation

S P K R 12 03 **ED 08** S R - MX



9 Hand

S P K R 12 03 **ED 08** S R - MX

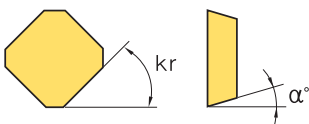


7 Nose radius (Nose R)

S P K R 12 03 **ED 08** S R - MX



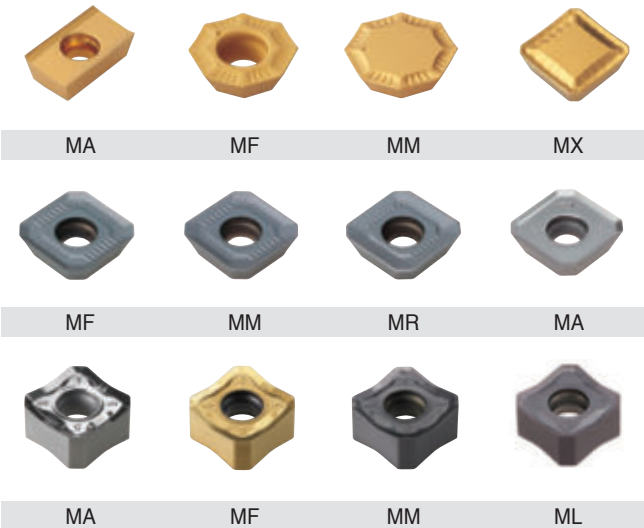
Symbol		r		Symbol		r	
Metric	Inch	Metric	Inch	Metric	Inch	Metric	Inch
00	0	0.0		12	3	1.2	3/64
02		0.2		15		1.5	
04	1	0.4	1/64	16	4	1.6	4/64
05		0.5		24	6	2.4	6/64
08	2	0.8	2/64	32	8	3.2	8/64
10		1.0		40		4.0	



Parallel Land		Relief Angle	
kr		α°	
A - 45°		A - 3°	F - 25°
D - 60°		B - 5°	G - 30°
E - 75°		C - 7°	N - 0°
F - 85°		D - 15°	P - 11°
P - 90°		E - 20°	
Z - Special			


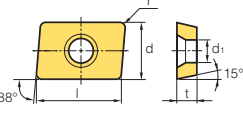

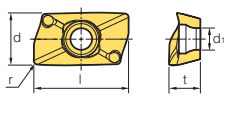

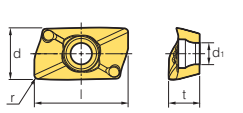

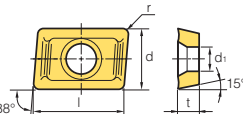

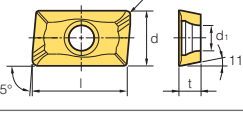
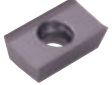
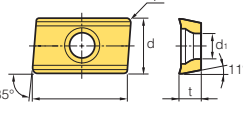

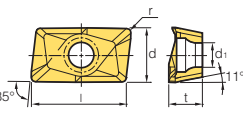

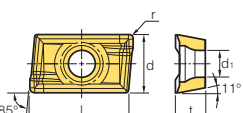

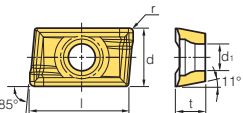

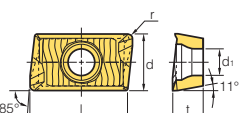
10 Chip breaker for milling

S P K R 12 03 **ED 08** S R - MX



E Milling Inserts


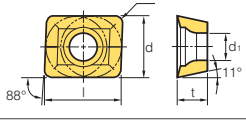
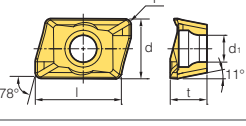

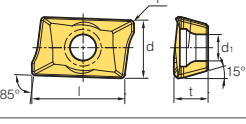
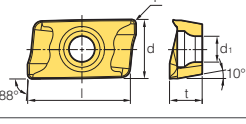
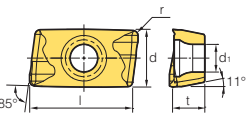
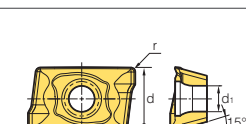
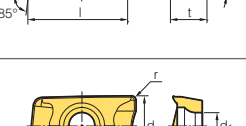
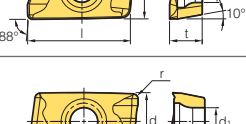
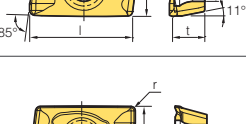
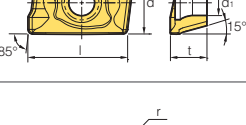
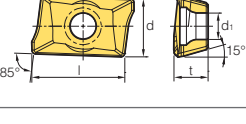
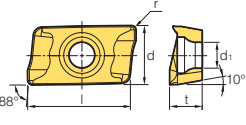

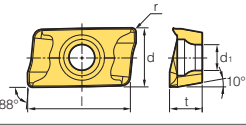
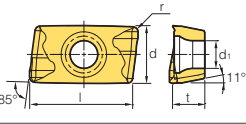
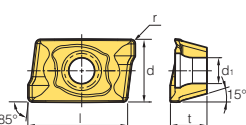
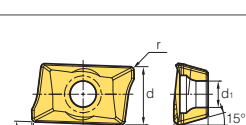

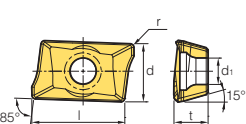
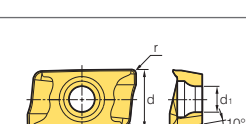


Workpiece	Steel	P											Machining types	
	Stainless steel	M											● Continuous cutting	
	Cast iron	K											● General cutting	
	Non-ferrous metal	N											● Interrupted cutting	
	Heat resistant alloy, Titanium alloy	S												
Hardened steel	H													

Inserts	Designation	Cermet		Coated								Uncoated		Dimensions (mm)					Geometries	Available tools			
		CN2500	CN30	NC5330	NCM325	NCM335	NCM535	NCM545	PC2010	PC3700	PC6510	PC9530	PC9540	PC5300	PC5400	H01	H05	l			d	t	r
	150308R																11.7	6.424	3.819	0.4	2.8		-
	150308SR																14.5	7.813	4.824	0.8	3.4		
	150308TR	●															19.665	10.843	6.529	0.8	4.5		
	10T304PEER-ML						●			●	●	●	●				11.7	6.424	3.819	0.4	2.8		E197~ E200
	120408PESR-ML						●			●	●	●	●				14.5	7.813	4.824	0.8	3.4		
	170608PESR-ML							●			●	●	●	●			19.665	10.843	6.529	0.8	4.5		
	10T304PESR-MM						●			●	●	●	●				11.7	6.424	3.819	0.4	2.8		E197~ E200
	10T308PESR-MM												●	●			11.7	6.424	3.819	0.8	2.8		
	10T312PESR-MM													●			11.7	6.424	3.819	1.2	2.8		
	120408PESR-MM							●			●	●	●	●			14.5	7.813	4.824	0.8	3.4		
	120412PESR-MM										●	●	●	●			14.5	7.813	4.824	1.2	3.4		
	120416PESR-MM										●	●	●	●			14.5	7.813	4.824	1.6	3.4		
	170604PESR-MM													●			19.665	10.843	6.529	0.4	4.5		
	170608PESR-MM													●	●		19.665	10.843	6.529	0.8	4.5		
170616PESR-MM														●	●	19.665	10.843	6.529	1.6	4.5			
170620PESR-MM															●	●	19.665	10.843	6.529	2.0	4.5		
	150308R																15.0	9.525	3.18	0.8	4.5		E307
	150308SR																15.0	9.525	3.18	0.8	4.5		
	150308TR																15.0	9.525	3.18	0.8	4.5		
	1604PDSR						●				●	●					16.4	9.525	4.76	0.8	4.4		E168 E180
	1604PDFR-MA														●	●	16.4	9.525	4.76	0.2	4.4		
	160416FR-MA														●		16.4	9.525	4.76	1.6	4.4		E168 E180
	160432FR-MA2																16.5	9.56	5.55	3.2	4.5		
	160416FR-MA2																16.5	9.56	5.67	1.6	4.5		E158 E170
	160420FR-MA3																16.0	9.525	5.0	2.0	4.4		
	160420FR-MA3																16.0	9.525	5.0	2.0	4.4		E158 E170
	1604PDSR-MF						●							●			16.4	9.525	5.0	0.8	4.4		
	1604PDSR-MM						●	●									16.4	9.525	5.2	0.8	4.4		E158 E170
	1604PDSR-MM						●	●									16.4	9.525	5.2	0.8	4.4		
	1604PDSR-MM						●	●									16.4	9.525	5.2	0.8	4.4		E168 E180 E189
	1604PDSR-MM						●	●									16.4	9.525	5.2	0.8	4.4		

● : Stock item



Workpiece	Machining types										
	P	M	K	N	S	H	●	⊕	⊛	⊠	⊡
Steel	●	●	●	●	●	●	●	●	●	●	●
Stainless steel	●	●	●	●	●	●	●	●	●	●	●
Cast iron	●	●	●	●	●	●	●	●	●	●	●
Non-ferrous metal	●	●	●	●	●	●	●	●	●	●	●
Heat resistant alloy, Titanium alloy	●	●	●	●	●	●	●	●	●	●	●
Hardened steel	●	●	●	●	●	●	●	●	●	●	●


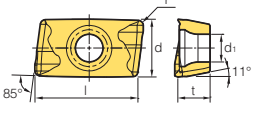


Inserts	Designation	Coating										Dimensions (mm)					Geometries	Available tools							
		Cermet		Coated								Uncoated		l	d	t			r	d ₁					
		CN2500	CN30	NC5330	NCM535	NCM545	PC2505	PC2510	PC2010	PC3700	PC6510	PC9530	PC9540	PC5300	PC5400	G10	H01								
	070304R	●																7.5	6.35	3.18	0.4	2.8		E305	
	0602PDRF-MA															●		6	4.24	2.6	0.4	2.0		E164 E175 E185 E188 E190	
	060208PDRF-MA																	6	4.24	2.6	0.8	2.0		E165 E176 E177 E185 E191	
	0903PDRF-MA															●		9.4	6.21	3.6	0.4	2.8		E166 E172 E178 E186 E189 E192	
	090308PDRF-MA																	9.4	6.21	3.6	0.8	2.8		E167 E173 E179	
	11T3PDRF-MA															●		11.2	6.467	3.6	0.5	2.9		E169 E174 E181 E182 E187	
	11T308PDRF-MA																	11.2	6.467	3.6	0.8	2.9		E169 E174 E181 E182 E187	
	160404PDRF-MA															●		16.4	9.41	5.76	0.4	4.5		E166, 170 E172, 178 E183, 186 E189, 192	
	1604PDRF-MA																	16.4	9.41	5.76	0.8	4.5		E167 E171 E173 E179 E184 E189	
	180604PDRF-MA															●		17.4	10.98	6.35	0.4	4.5		E169 E174 E181 E182 E187	
	1806PDRF-MA															●		17.4	10.98	6.35	0.8	4.5		E169 E174 E181 E182 E187	
	180612PDRF-MA															●		17.4	10.98	6.35	1.2	4.5			
	180616PDRF-MA															●		17.4	10.98	6.35	1.6	4.5			
	180620PDRF-MA															●		17.4	10.98	6.35	2.0	4.5			
	180624PDRF-MA															●		17.4	10.98	6.35	2.4	4.5			
	180630R-MA															●		17.4	10.98	6.35	3.0	4.5			
	11T3PDSR-MF			●						●	●			●	●			11.2	6.467	3.6	0.5	2.9		E166, 170 E172, 178 E183, 186 E189, 192	
	1604PDSR-MF			●						●	●			●	●			16.4	9.41	5.76	0.8	4.5		E167 E171 E173 E179 E184 E189	
	1806PDSR-MF			●						●				●	●			17.4	10.98	6.35	0.8	4.5		E169 E174 E181 E182 E187	
	180612PDSR-MF			●						●				●	●			17.4	10.98	6.35	1.2	4.5			
	0903PDER-ML															●	●	9.4	6.21	3.6	0.4	2.8		E165 E176 E177 E185 E191	
	090308PDER-ML															●	●	9.4	6.21	3.6	0.8	2.8			
	11T3PDER-ML															●	●	11.2	6.467	3.6	0.5	2.9		E166 E172 E178 E186 E189 E192	
	11T308PDER-ML															●	●	11.2	6.467	3.6	0.8	2.9			

● : Stock item



E Milling Inserts

Workpiece	Machining types											
	P	M	K	N	S	H	●	●	●	●	●	●
Steel	●	●	●	●	●	●	●	●	●	●	●	●
Stainless steel	●	●	●	●	●	●	●	●	●	●	●	●
Cast iron	●	●	●	●	●	●	●	●	●	●	●	●
Non-ferrous metal	●	●	●	●	●	●	●	●	●	●	●	●
Heat resistant alloy, Titanium alloy	●	●	●	●	●	●	●	●	●	●	●	●
Hardened steel	●	●	●	●	●	●	●	●	●	●	●	●


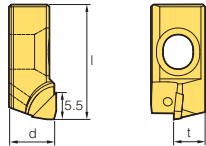

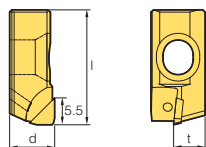

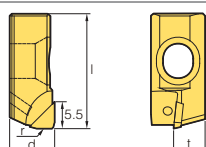

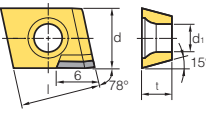

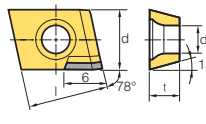

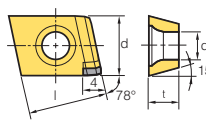
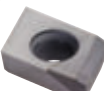
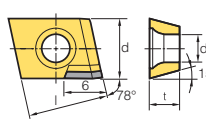

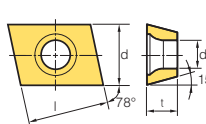

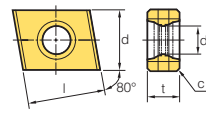
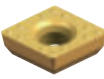
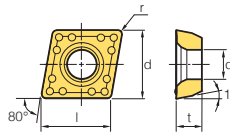
Inserts	Designation	Cermets		Coated								PCD		Dimensions (mm)					Geometries	Available tools			
		CN2500	CN30	NC5330	NCM325	NCM535	PC2505	PC2510	PC2010	PC3700	PC6510	PC9530	PC9540	PC5300	PC5400	DP150	DP200	l			d	t	r
APMT-ML 	160404PDER-ML	●															16.4	9.41	5.76	0.4	4.5		E167
	1604PDER-ML																16.4	9.41	5.76	0.8	4.5		E173
	180604PDER-ML													●	●			17.4	10.98	6.35	0.4	4.5	E181
	1806PDER-ML													●	●			17.4	10.98	6.35	0.8	4.5	E182
	180612PDER-ML													●	●			17.4	10.98	6.35	1.2	4.5	E187
	180616PDER-ML													●	●			17.4	10.98	6.35	1.6	4.5	E187
	180620PDER-ML													●	●			17.4	10.98	6.35	2.0	4.5	E187
APMT-MM 	180624PDER-ML												●	●			17.4	10.98	6.35	2.4	4.5	E187	
	180630R-ML												●	●			17.4	10.98	6.35	3.0	4.5	E187	
	060202PDSR-MM			●						●			●	●			6	4.24	2.6	0.2	2.0	E164, 170	
	0602PDSR-MM			●			●	●		●	●	●	●	●			6	4.24	2.6	0.4	2.0	E175, 183	
	060208PDSR-MM			●						●			●	●			6	4.24	2.6	0.8	2.0	E185, 188	
	060212R-MM			●									●	●			6	4.24	2.6	1.2	2.0	E190	
	060216R-MM *			●									●	●			6	4.24	2.6	1.6	2.0	E190	
	0903PDSR-MM			●			●	●		●	●	●	●	●			9.4	6.21	3.6	0.4	2.8	E165	
	090308PDSR-MM			●						●			●	●			9.4	6.21	3.6	0.8	2.8	E176	
	090312R-MM			●						●			●	●			9.4	6.21	3.6	1.2	2.8	E177	
	090316R-MM			●						●			●	●			9.4	6.21	3.6	1.6	2.8	E185	
	090320R-MM			●						●			●	●			9.2	6.21	3.6	2.0	2.8	E191	
	090332R-MM *			●						●			●	●			9.2	6.21	3.6	3.2	2.8	E191	
	11T3PDSR-MM			●	●	●	●	●		●	●	●	●	●			11.2	6.467	3.6	0.5	2.85	E166, 170	
	11T308PDSR-MM			●						●			●	●			11.2	6.467	3.6	0.8	2.85	E172, 178	
	11T312PDSR-MM			●						●			●	●			11.2	6.467	3.6	1.2	2.85	E183, 186	
	11T316R-MM			●						●			●	●			11.0	6.467	3.6	1.6	2.85	E189, 192	
	11T318R-MM			●						●			●	●			11.0	6.467	3.6	1.8	2.85	E189, 192	
	11T324R-MM			●						●			●	●			11.0	6.467	3.6	2.4	2.85	E189, 192	
	160404PDSR-MM			●										●	●			16.4	9.41	5.76	0.4	4.5	E167
	1604PDSR-MM			●	●	●	●	●		●	●	●	●	●			16.4	9.41	5.76	0.8	4.5	E171	
	160410PDSR-MM			●						●			●	●			16.4	9.41	5.76	1.0	4.5	E173	
	160416PDSR-MM			●						●			●	●			16.4	9.41	5.76	1.6	4.5	E179	
	160420R-MM			●						●			●	●			16.4	9.41	5.76	2.0	4.5	E184	
	160424R-MM			●						●			●	●			16	9.41	5.76	2.4	4.5	E189	
	160430R-MM			●						●			●	●			16	9.41	5.76	3.0	4.5	E189	
	160432R-MM			●						●			●	●			16	9.41	5.76	3.2	4.5	E189	
	160450R-MM *			●						●			●	●			16	9.41	5.76	5.0	4.5	E189	
	160464R-MM *			●						●			●	●			16	9.41	5.76	6.4	4.5	E189	
	1806PDSR-MM			●			●	●		●	●	●	●	●			17.4	10.98	6.35	0.8	4.5	E169	
	180612PDSR-MM			●						●			●	●			17.4	10.98	6.35	1.2	4.5	E174	
	180616PDSR-MM			●						●			●	●			17.4	10.98	6.35	1.6	4.5	E181	
180620PDSR-MM			●						●			●	●			17.4	10.98	6.35	2.0	4.5	E182		
180624PDSR-MM			●						●			●	●			17.4	10.98	6.35	2.4	4.5	E187		
180630R-MM			●						●			●	●			16.7	10.98	6.35	3.0	4.5	E187		
180632R-MM			●						●			●	●			16.7	10.98	6.35	3.2	4.5	E187		
180640R-MM *			●						●			●	●			16.7	10.98	6.35	4.0	4.5	E187		
180648R-MM *			●						●			●	●			16.7	10.98	6.35	4.8	4.5	E187		
180650R-MM *			●						●			●	●			16.7	10.98	6.35	5.0	4.5	E187		
180660R-MM *			●						●			●	●			16.7	10.98	6.35	6.0	4.5	E187		
180664R-MM *			●						●			●	●			16.7	10.98	6.35	6.4	4.5	E187		
APMT-MN 	11T3PDSR-MN2			●					●			●	●			11.2	6.467	3.6	0.5	2.85	E166, 167		
	11T3PDSR-MN3			●					●			●	●			11.2	6.467	3.6	0.5	2.85	E172, 173		
	1604PDSR-MN3			●					●			●	●			16.4	9.41	5.76	0.8	4.5	E174, 178		
	1604PDSR-MN4			●					●			●	●			16.4	9.41	5.76	0.8	4.5	E179, 181		
	1806PDSR-MN3			●					●			●	●			17.4	10.98	6.35	0.8	4.5	E182, 186		
	1806PDSR-MN4			●					●			●	●			17.4	10.98	6.35	0.8	4.5	E187, 192		

* Inserts marked with an asterisk (*) require a custom-made order for special holders.

● : Stock item



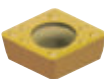
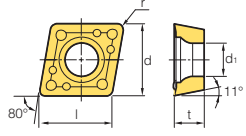

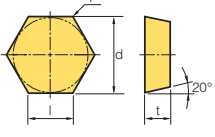

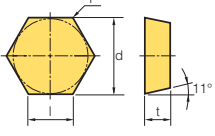

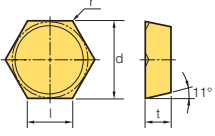
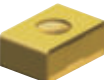
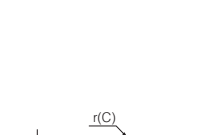
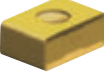
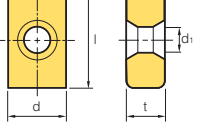
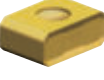


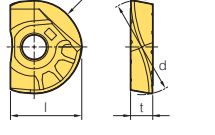

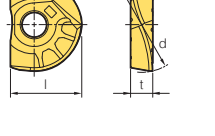
Workpiece	Steel	P	●	●	●	●	●	●	●	●	●	●	●	●	●	●	●	Machining types ● Continuous cutting ● General cutting ✦ Interrupted cutting
	Stainless steel	M																
	Cast iron	K																
	Non-ferrous metal	N																
	Heat resistant alloy, Titanium alloy	S																
Hardened steel	H																	

Inserts	Designation	Cermet		Coated								PCD	Dimensions (mm)					Geometries	Available tools					
		CN2500	CN30	NC5330	NCM535	NCM545	PC2505	PC2010	PC3700	PC6510	PC9530		PC9540	PC5300	PC5400	H01	DP150			DP200	l	d	t	r
	BAMPR-XAF																25.5	10.5	7	-	-		E152 E153	
	BAMPR-XAW												●				25.5	10	7	-	-		E152 E153	
	BAMPR-XAWR												●				25.5	10	7	-	-		E152 E153	
	1204R-NAF																12.7	9.525	4.76	-	4.4		E151	
	1204L-NAF																12.7	9.525	4.76	-	4.4			
strengthened Edge																								
	1204R-NAW																12.7	9.525	4.76	-	4.4		E151	
	1204L-NAW																12.7	9.525	4.76	-	4.4			
Strengthened Edge Wiper Insert																								
	1204R-XAW												●				12.7	9.525	4.76	-	4.4		E151	
	1204L-XAW																12.7	9.525	4.76	-	4.4			
Sharp Edge Wiper Insert																								
	1204R-XAF												●				12.7	9.525	4.76	-	4.4		E151	
	1204L-XAF																12.7	9.525	4.76	-	4.4			
Sharp Edge																								
	1204R-XCF												●				12.7	9.525	4.76	-	4.4		E136	
	1204L-XCF																12.7	9.525	4.76	-	4.4			
Sharp Edge																								
	1005-C0.5																10	10	5.4	-	4.7		E305 E306	
	1305-C0.5																12.7	10	5.4	-	4.7			
	1606-C0.5																16	12	6.4	-	5.9			
	120408-MM																12.9	12.7	4.76	0.8	5.5		E372	

● : Stock item

E Milling Inserts

Workpiece	Steel	P	●	●	●	●	●	●	●	●	●	●	●	●	●	●	●	●	Machining types
	Stainless steel	M																	
Cast iron	K																		<ul style="list-style-type: none"> ● Continuous cutting ● General cutting ● Interrupted cutting
Non-ferrous metal	N																		
Heat resistant alloy, Titanium alloy	S																		
Hardened steel	H																		

Inserts	Designation	Cermets		Coated							Uncoated		Dimensions (mm)					Geometries	Available tools			
		CN2500	CN30	NCM535	NCM545	PC2505	PC2010	PC2015	PC210F	PC3700	PC6510	PC9530	PC9540	PC5400	ST30A	H01	l			d	t	r
	060204-MM									●						6.4	6.35	2.38	0.4	2.75		E372
	080308-MM									●						8.1	7.938	3.18	0.8	3.40		
	09T308-MM										●						9.7	9.525	3.97	0.8		
	090408FN															9.0	15.875	4.76	0.8	-		E417
	090408SN															9.0	15.875	4.76	0.8	-		
	090408TN															9.0	15.875	4.76	0.8	-		
	110412FN															11.0	19.05	4.76	1.2	-		
	110412TN															11.0	19.05	4.76	1.2	-		
	090408FN															9.0	15.875	4.76	0.8	-		E417
	090408SN															9.0	15.875	4.76	0.8	-		
	090408EN															9.0	15.875	4.76	0.8	-		
	110412FN															11.0	19.05	4.76	1.2	-		
	090408-WC															9.0	15.875	4.76	0.8	-		E417
	110412-WC															11.0	19.05	4.76	1.2	-		
	150608-MF															15.88	15.23	6.35	0.8	-		E429
	150608-ML															15.88	15.23	6.35	0.8	-		
	1506QNN-MF															15.88	15.23	6.35	0.8	-		
	1506QNN-ML															15.88	15.23	6.35	0.8	-		
	1506ANN-MF															15.88	15.23	6.35	0.8	-		
	1506ANN-ML															15.88	15.23	6.35	0.8	-		
	080									●						7.0	8	2.4	4.0	-		E325~ E328
	100									●						8.5	10	2.6	5.0	-		
	120									●						10.0	12	3.0	6.0	-		
	160									●						12.0	16	4.0	8.0	-		
	200									●						15.0	20	5.0	10.0	-		
	250									●						18.5	25	6.0	12.5	-		
	300									●						22.5	30	7.0	15.0	-		
	320									●						23.5	32	7.0	16.0	-		
	330									●						24.0	33	7.0	16.5	-		
	080-KF															7.0	8	2.4	4.0	-		E324 E325
	100-KF									●						8.5	10	2.6	5.0	-		
	120-KF									●						10.0	12	3.0	6.0	-		
	130-KF									●						20.5	13	3.0	6.5	-		
	160-KF									●						12.0	16	4.0	8.0	-		
	170-KF									●						12.5	17	4.0	8.5	-		
	200-KF									●						15.0	20	5.0	10.0	-		
	210-KF									●						15.5	21	5.0	10.5	-		
	250-KF									●						18.5	25	6.0	12.5	-		
	300-KF									●						22.5	30	7.0	15.0	-		
	320-KF									●						23.5	32	7.0	16.0	-		
330-KF									●						24.0	33	7.0	16.5	-			


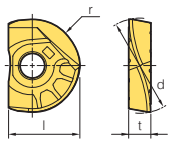


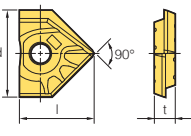

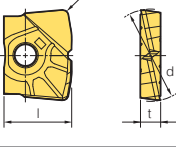
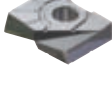
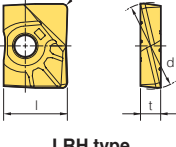
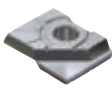
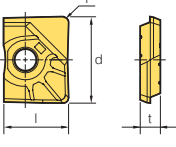
● : Stock item



Workpiece	Steel	P	●	●	●	●	●	●	●	●	●	●	●	●	●	●	●	●	●
	Stainless steel	M	●	●	●	●	●	●	●	●	●	●	●	●	●	●	●	●	●
	Cast iron	K	●	●	●	●	●	●	●	●	●	●	●	●	●	●	●	●	●
	Non-ferrous metal	N	●	●	●	●	●	●	●	●	●	●	●	●	●	●	●	●	●
	Heat resistant alloy, Titanium alloy	S	●	●	●	●	●	●	●	●	●	●	●	●	●	●	●	●	●
Hardened steel	H	●	●	●	●	●	●	●	●	●	●	●	●	●	●	●	●	●	●

Machining types

- Continuous cutting
- General cutting
- ✦ Interrupted cutting

Inserts	Designation	Cermets		Coated								Uncoated		Dimensions (mm)					Geometries	Available tools			
		CN2500	CN30	NC5330	NCM535	NCM545	PC2505	PC2010	PC210F	PC3700	PC6510	PC9530	PC9540	PC5300	PC5400	ST30A	H01	l			d	t	r
 LBH-KH	080-KH								●								7.0	8	2.4	4.0	-		E324 E325
	100-KH							●	●								8.5	10	2.6	5.0	-		
	120-KH							●	●								10.0	12	3.0	6.0	-		
	130-KH							●	●								20.5	13	3.0	6.5	-		
	160-KH							●	●								12.0	16	4.0	8.0	-		
	170-KH							●	●								12.5	17	4.0	8.5	-		
	200-KH							●	●								15.0	20	5.0	10.0	-		
	210-KH							●	●								15.5	21	5.0	10.5	-		
	250-KH							●	●								18.5	25	6.0	12.5	-		
	260-KH							●	●								19.0	26	6.0	13.0	-		
	300-KH							●	●								22.5	30	7.0	15.0	-		
	320-KH							●	●								23.5	32	7.0	16.0	-		
	330-KH								●								24.0	33	7.0	16.5	-		
	 LBS	080																7.0	8	2.4	4.0		
090																	7.5	9	2.4	4.5	-		
100																	8.5	10	2.6	5.0	-		
110																	9.0	11	2.6	5.5	-		
120																	10.0	12	3.0	6.0	-		
130																	10.5	13	3.0	6.5	-		
160																	12.0	16	4.0	8.0	-		
170																	12.5	17	4.0	8.5	-		
200																	15.0	20	5.0	10.0	-		
210																	15.5	21	5.0	10.5	-		
250																	18.5	25	6.0	12.5	-		
260																	19.0	26	6.0	13.0	-		
 LCF	160-D90																13.7	16	4.0	-	-		E325~ E328
	200-D90																17.0	20	5.0	-	-		
	250-D90																21.5	25	6.0	-	-		
 LFH	100																8.5	10	2.6	1.0	-		E325~ E328
	120																10.0	12	3.0	1.0	-		
	160																12.0	16	4.0	1.5	-		
	200																15.0	20	5.0	1.5	-		
	250																18.5	25	6.0	2.0	-		
	300																22.5	30	7.0	2.0	-		
 LRH	100-R05																8.5	10	2.6	0.5	-		E325~ E328
	100-R10																8.5	10	2.6	1.0	-		
	100-R20																8.5	10	2.6	2.0	-		
	110-R05																9.0	11	2.6	0.5	-		
	120-R05																10.0	12	3.0	0.5	-		
	120-R10																10.0	12	3.0	1.0	-		
	120-R20																10.0	12	3.0	2.0	-		
	130-R05																10.5	13	3.0	0.5	-		
	130-R10																10.5	13	3.0	1.0	-		
	160-R05																12.0	16	4.0	0.5	-		
 LR (Special type)	160-R10																12.0	16	4.0	1.0	-		
	160-R20																12.0	16	4.0	2.0	-		
	160-R30																12.0	16	4.0	3.0	-		
	170-R05																12.5	17	4.0	0.5	-		
	170-R10																12.5	17	4.0	1.0	-		
	200-R05																15.0	20	5.0	0.5	-		
	200-R10																15.0	20	5.0	1.0	-		
	200-R20																15.0	20	5.0	2.0	-		
	200-R30																15.0	20	5.0	3.0	-		
	210-R05																15.5	21	5.0	0.5	-		

● : Stock item



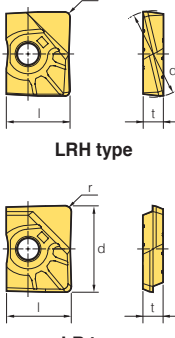

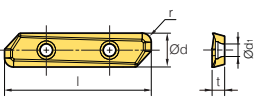

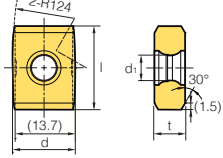
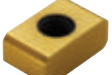
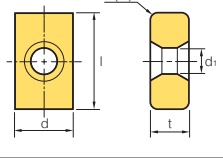

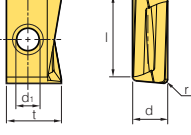


E Milling Inserts

Workpiece	Machining types										
	P	M	K	N	S	H					
Steel	●	●	●	●	●	●	●	●	●	●	●
Stainless steel	●	●	●	●	●	●	●	●	●	●	●
Cast iron	●	●	●	●	●	●	●	●	●	●	●
Non-ferrous metal	●	●	●	●	●	●	●	●	●	●	●
Heat resistant alloy, Titanium alloy	●	●	●	●	●	●	●	●	●	●	●
Hardened steel	●	●	●	●	●	●	●	●	●	●	●

Machining types


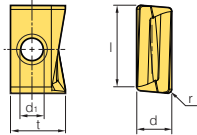

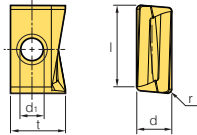

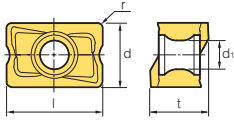

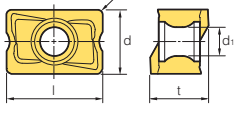

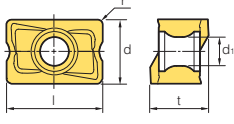
- Continuous cutting
- General cutting
- Interrupted cutting

Inserts	Designation	Cermet		Coated							Uncoated		Dimensions (mm)					Geometries	Available tools				
		CN2500	CN30	NC5330	NCM535	NCM545	PC2505	PC2010	PC210F	PC3700	PC6510	PC9530	PC9540	PC5300	PC5400	ST30A	H01			l	d	t	r
LRH  LR  (Special type)	210-R10							●									15.5	21	5.0	1.0	-	 LRH type LR type	E325~ E328
	250-R05																18.5	25	6.0	0.5	-		
	250-R10								●								18.5	25	6.0	1.0	-		
	250-R20									●							18.5	25	6.0	2.0	-		
	250-R30										●						18.5	25	6.0	3.0	-		
	260-R05								●								19.0	26	6.0	0.5	-		
	260-R10								●								19.0	26	6.0	1.0	-		
	300-R10																22.5	30	7.0	1.0	-		
	300-R20																22.5	30	7.0	2.0	-		
	300-R30																22.5	30	7.0	3.0	-		
	310-R05																23.0	31	7.0	0.5	-		
	320-R10									●							23.5	32	7.0	1.0	-		
	320-R20									●							23.5	32	7.0	2.0	-		
	320-R30									●							23.5	32	7.0	3.0	-		
	330-R05																24.0	33	7.0	0.5	-		
330-R10																24.0	33	7.0	1.0	-			
330-R20																24.0	33	7.0	2.0	-			
330-R30																24.0	33	7.0	3.0	-			
LDET-MA <small>new</small> 	650540PPFR-MA																65	15	5.625	4.0	5.56		E396
	650550PPFR-MA																65	15	5.625	5.0	5.56		
LNCS 	1907-C1.5-WC																19.05	14.3	7	-	5.8		E423
	1907-R3.0-WC																19.05	14.3	7	-	5.8		
LNE 	324-R0.8																15.9	9.525	6.35	0.8	4.4		E429~ E433
	324-C1.0																15.9	9.525	6.35	1.0	4.4		
LNKT-MA <small>new</small> 	080404PNR-MA																8.0	4.2	6.6	0.4	2.8		E309~ E314
	080408PNR-MA																8.0	4.2	6.6	0.8	2.8		
	080412PNR-MA																8.0	4.2	6.6	1.2	2.8		
	080416PNR-MA																8.0	4.2	6.6	1.6	2.8		
	140604PNR-MA																12.7	6.65	10.0	0.4	4.0		
	140608PNR-MA																12.7	6.65	10.0	0.8	4.0		
	140612PNR-MA																12.7	6.65	10.0	1.2	4.0		
	140616PNR-MA																12.7	6.65	10.0	1.6	4.0		
	170704PNR-MA																16.5	7.0	11.0	0.4	4.5		
	170708PNR-MA																16.5	7.0	11.0	0.8	4.5		
	170712PNR-MA																16.5	7.0	11.0	1.2	4.5		
170716PNR-MA																16.5	7.0	11.0	1.6	4.5			
170720PNR-MA																16.5	7.0	11.0	2.0	4.5			

● : Stock item



Workpiece	Machining types											
	Steel	P	M	K	N	S	H	●	⊕	⊛	⊚	⊙
Steel	●	●	●	●	●	●	●	●	●	●	●	●
Stainless steel	●	●	●	●	●	●	●	●	●	●	●	●
Cast iron	●	●	●	●	●	●	●	●	●	●	●	●
Non-ferrous metal	●	●	●	●	●	●	●	●	●	●	●	●
Heat resistant alloy, Titanium alloy	●	●	●	●	●	●	●	●	●	●	●	●
Hardened steel	●	●	●	●	●	●	●	●	●	●	●	●

Inserts	Designation	Cermet		Coated							Uncoated		Dimensions (mm)					Geometries	Available tools				
		CN2500	CN30	NC5330	NCM535	NCM545	PC2505	PC2010	PC210F	PC3700	PC6510	PC9530	PC9540	PC5300	PC5400	ST30A	H01			l	d	t	r
LNKT-ML 	080404PNR-ML																8.0	4.2	6.6	0.4	2.8		E309~ E314
	080408PNR-ML																8.0	4.2	6.6	0.8	2.8		
	080412PNR-ML																8.0	4.2	6.6	1.2	2.8		
	080416PNR-ML																8.0	4.2	6.6	1.6	2.8		
	140604PNR-ML																12.7	6.65	10.0	0.4	4.0		
	140608PNR-ML																12.7	6.65	10.0	0.8	4.0		
	140612PNR-ML																12.7	6.65	10.0	1.2	4.0		
	140616PNR-ML																12.7	6.65	10.0	1.6	4.0		
	170704PNR-ML																16.5	7.0	11.0	0.4	4.5		
	170708PNR-ML									●			●	●			16.5	7.0	11.0	0.8	4.5		
	170712PNR-ML																16.5	7.0	11.0	1.2	4.5		
	170716PNR-ML																16.5	7.0	11.0	1.6	4.5		
	170720PNR-ML																16.5	7.0	11.0	2.0	4.5		
LNKT-MM 	080404PNR-MM															8.0	4.2	6.6	0.4	2.8		E309~ E314	
	080408PNR-MM															8.0	4.2	6.6	0.8	2.8			
	080412PNR-MM															8.0	4.2	6.6	1.2	2.8			
	080416PNR-MM															8.0	4.2	6.6	1.6	2.8			
	140604PNR-MM															12.7	6.65	10.0	0.8	4.0			
	140608PNR-MM															12.7	6.65	10.0	0.8	4.0			
	140612PNR-MM															12.7	6.65	10.0	1.2	4.0			
	140616PNR-MM															12.7	6.65	10.0	1.6	4.0			
	170704PNR-MM															16.5	7.0	11.0	0.4	4.5			
	170708PNR-MM												●	●		16.5	7.0	11.0	0.8	4.5			
170712PNR-MM															16.5	7.0	11.0	1.2	4.5				
170716PNR-MM															16.5	7.0	11.0	1.6	4.5				
170720PNR-MM															16.5	7.0	11.0	2.0	4.5				
LNEX-MA 	100605PNR-MA													●	10.0	6.5	6.5	0.5	3.5		E105 E106 E109 E110 E113~ E117		
	151004PNR-MA													●	15.0	10.0	10.0	0.4	4.5				
	151008PNR-MA													●	15.0	10.0	10.0	0.8	4.5				
LNM(E)X-MF 	LNMX 100605PNR-MF									●		●	●		10.0	6.5	6.5	0.5	3.5		E105 E106 E109 E110 E113~ E117		
	100608PNR-MF									●		●	●		10.0	6.5	6.5	0.8	3.5				
	151004PNR-MF									●	●		●	●	15.0	10.0	10.0	0.4	4.5				
	151008PNR-MF				●					●	●		●	●	15.0	10.0	10.0	0.8	4.5				
	151016PNR-MF									●			●		15.0	10.0	10.0	1.6	4.5				
	LNEX 100605PNR-MF									●		●	●		10.0	6.5	6.5	0.5	3.5				
	100608PNR-MF									●	●		●	●	10.0	6.5	6.5	0.8	3.5				
	151004PNR-MF									●			●	●	15.0	10.0	10.0	0.4	4.5				
	151008PNR-MF									●	●		●	●	15.0	10.0	10.0	0.8	4.5				
	151016PNR-MF									●			●		15.0	10.0	10.0	1.6	4.5				
LNM(E)X-MM 	LNMX 100605PNR-MM									●	●	●	●		10.0	6.5	6.5	0.5	3.5		E105~ E119		
	100608PNR-MM									●		●	●		10.0	6.5	6.5	0.8	3.5				
	100605PNL-MM									●	●		●	●	10.0	6.5	6.5	0.5	3.5				
	151004PNR-MM									●			●	●	15.0	10.0	10.0	0.4	4.5				
	151008PNR-MM				●					●	●		●	●	15.0	10.0	10.0	0.8	4.5				
	151016PNR-MM									●	●		●		15.0	10.0	10.0	1.6	4.5				
	151008PNL-MM									●			●	●	15.0	10.0	10.0	0.8	4.5				
	LNEX 100605PNR-MM									●	●		●	●	10.0	6.5	6.5	0.5	3.5				
	100608PNR-MM									●			●	●	10.0	6.5	6.5	0.8	3.5				
	100605PNL-MM									●	●		●	●	10.0	6.5	6.5	0.5	3.5				
	151004PNR-MM									●			●	●	15.0	10.0	10.0	0.4	4.5				
	151008PNR-MM									●	●		●	●	15.0	10.0	10.0	0.8	4.5				
	151016PNR-MM									●			●		15.0	10.0	10.0	1.6	4.5				
151008PNL-MM									●			●	●	15.0	10.0	10.0	0.8	4.5					


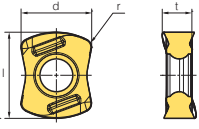

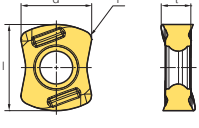

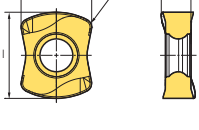

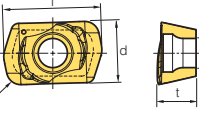

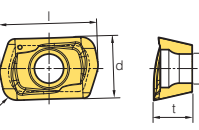
● : Stock item

E Milling Inserts

Workpiece	Machining types										
	P	M	K	N	S	H	●	⊙	⊚	⊛	⊜
Steel	●	●	●	●	●	●	●	●	●	●	●
Stainless steel	●	●	●	●	●	●	●	●	●	●	●
Cast iron	●	●	●	●	●	●	●	●	●	●	●
Non-ferrous metal	●	●	●	●	●	●	●	●	●	●	●
Heat resistant alloy, Titanium alloy	●	●	●	●	●	●	●	●	●	●	●
Hardened steel	●	●	●	●	●	●	●	●	●	●	●

Machining types


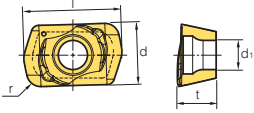
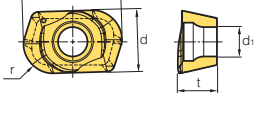

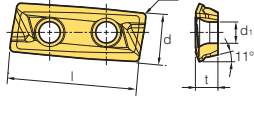

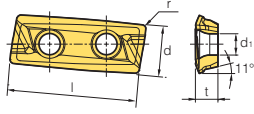
- Continuous cutting
- ⊙ General cutting
- ⊚ Interrupted cutting

Inserts	Designation	Cemet		Coated							Uncolated		Dimensions (mm)					Geometries	Available tools			
		CN2500	CN30	NC5330	NCM535	NCM545	PC2505	PC2510	PC2010	PC3700	PC6510	PC9530	PC9540	PC5300	PC5400	ST30A	H01			l	d	t
LNMX-MF 	060310R-MF	●					●	●					●	●		10.0	6.8	3.6	1.0	-		E269~ E273 E275 E276
	100412R-MF	●					●	●					●	●		12.2	10.0	4.2	1.2	-		
LNMX-ML 	040205R-ML	●											●	●		6.2	4.2	2.35	0.5	-		E267~ E276
	060310R-ML	●											●	●		10.0	6.8	3.6	1.0	-		
	100412R-ML	●											●	●		12.2	10.0	4.2	1.2	-		
LNMX-MM 	040205R-MM	●					●	●					●	●		6.2	4.2	2.35	0.5	-		E267~ E276
	060310R-MM	●					●	●					●	●		10.0	6.8	3.6	1.0	-		
	100412R-MM	●					●	●					●	●		12.2	10.0	4.2	1.2	-		
LPEW 	040210R	●				●	●					●			6.4	4.2	2.6	1.0	2.0		E281~ E283	
	040220R	●				●	●					●			6.4	4.2	2.6	2.0	2.0			
LPMT-MF 	040210R-MF	●				●	●					●	●		6.4	4.2	2.6	2.0	2.0		E281~ E283	
	040220R-MF	●				●	●					●	●		6.4	4.2	2.6	2.0	2.0			

● : Stock item











Workpiece	Steel	P	●	●	●	●	●	●	●	●	●	●	●	●	●	●	Machining types	
	Stainless steel	M																● Continuous cutting ● General cutting ✦ Interrupted cutting
	Cast iron	K																
	Non-ferrous metal	N																
	Heat resistant alloy, Titanium alloy	S																
Hardened steel	H																	

Inserts	Designation	Cermet		Coated							Uncoated		Dimensions (mm)					Geometries	Available tools						
		CN2500	CN30	NC5330	NCM535	NCM545	PC2505	PC2510	PC2010	PC3700	PC6510	PC9530	PC9540	PC5300	PC5400	ST30A	H01			l	d	t	r	d _i	
LPMW 	040210R						●	●					●				6.4	4.2	2.6	1.0	2.0		E281~ E283		
	040220R						●	●					●				6.4	4.2	2.6	2.0	2.0				
LXET-MA 	250404PEFR-32-MA																25	10.775	4.76	0.4	4.5		E394~ E397		
	2504PEFR-32-MA																●	25	10.775	4.76	0.8			4.5	
	250412PEFR-32-MA																	25	10.775	4.76	1.2			4.5	
	250416PEFR-32-MA																	25	10.775	4.76	1.6			4.5	
	250404PEFR-40-MA																	25	10.618	4.76	0.4			4.5	
	2504PEFR-40-MA																	25	10.618	4.76	0.8			4.5	
	250412PEFR-40-MA																	25	10.618	4.76	1.2			4.5	
	250416PEFR-40-MA																	25	10.618	4.76	1.6			4.5	
	340504PEFR-50-MA																	●	34	13.765	5.56			0.4	5.56
	3405PEFR-50-MA																	●	34	13.765	5.56			0.8	5.56
	340512PEFR-50-MA																		34	13.765	5.56			1.2	5.56
	340516PEFR-50-MA																		34	13.765	5.56			1.6	5.56
	340504PEFR-63-MA																		34	13.803	5.56			0.4	5.56
3405PEFR-63-MA																	●	34	13.803	5.56	0.8	5.56			
340512PEFR-63-MA																		34	13.803	5.56	1.2	5.56			
340516PEFR-63-MA																		34	13.803	5.56	1.6	5.56			
LXET-ML 	250404PEER-32-ML																25	10.775	4.76	0.4	4.5		E394~ E397		
	2504PEER-32-ML																	25	10.775	4.76	0.8			4.5	
	250412PEER-32-ML																	25	10.775	4.76	1.2			4.5	
	250416PEER-32-ML																	25	10.775	4.76	1.6			4.5	
	250404PEER-40-ML																	25	10.618	4.76	0.4			4.5	
	2504PEER-40-ML																	25	10.618	4.76	0.8			4.5	
	250412PEER-40-ML																	25	10.618	4.76	1.2			4.5	
	250416PEER-40-ML																	25	10.618	4.76	1.6			4.5	
	340504PEER-50-ML																		34	13.765	5.56			0.4	5.56
	3405PEER-50-ML																	●	34	13.765	5.56			0.8	5.56
	340512PEER-50-ML																		34	13.765	5.56			1.2	5.56
	340516PEER-50-ML																		34	13.765	5.56			1.6	5.56
	340504PEER-63-ML																		34	13.803	5.56			0.4	5.56
3405PEER-63-ML																		34	13.803	5.56	0.8	5.56			
340512PEER-63-ML																		34	13.803	5.56	1.2	5.56			
340516PEER-63-ML																		34	13.803	5.56	1.6	5.56			

● : Stock item

E Milling Inserts

Workpiece	Steel	P													Machining types		
	Stainless steel	M													● Continuous cutting		
	Cast iron	K													⊕ General cutting		
	Non-ferrous metal	N													⊕ Interrupted cutting		
	Heat resistant alloy, Titanium alloy	S															
Hardened steel	H																


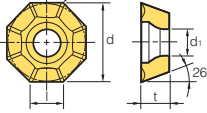

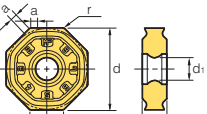

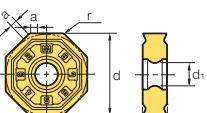

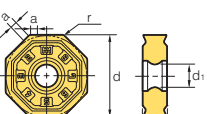

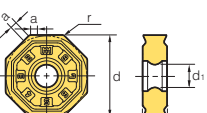

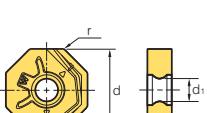

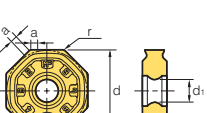

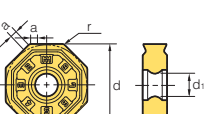

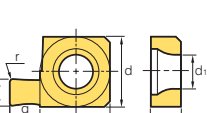
Inserts	Designation	Cermat		Coated							Uncoated	Dimensions (mm)					Geometries	Available tools												
		CN2500	CN30	NCM325	NCM335	NCM535	NCM545	PC2505	PC2010	PC3700	PC6510	PC9530	PC9540	PC5300	PC5400	ST30A			H01	l	d	t	r	d _i						
MPMT 	090308							●	●	●	●	●	●	●	●	●	●	●	●	●	●	●	●	●	●	●				
	120408										●																			
OFCN 	0704SN																					●								
	0704FN																													
	070408SN																													
	070408FN																													
	070408TN																													
OFCW 	05T3SN																													
	05T3FN																													
	05T308FN																													
OFKR-MA 	0704FN-MA																					●								
	0704EN-MA																													
OFKR-MF 	0704SN-MF				●	●																								
	070408SN-MF																													
OFKR-MM 	0704SN-MM				●	●								●																
	070408SN-MM				●																									
OFKT-MA 	05T3FN-MA																					●								
	05T3EN-MA																													
	0704FN-MA																						●							
	0704EN-MA																													
OFKT-MF 	05T3SN-MF																													
	05T308SN-MF																													

● : Stock item



Workpiece	Steel	P	●	●	●	●	●	●	●	●	●	●	●	●	●	●	●	●	Machining types
	Stainless steel	M	●	●	●	●	●	●	●	●	●	●	●	●	●	●	●	●	
	Cast iron	K	●	●	●	●	●	●	●	●	●	●	●	●	●	●	●	●	
	Non-ferrous metal	N	●	●	●	●	●	●	●	●	●	●	●	●	●	●	●	●	
	Heat resistant alloy, Titanium alloy	S	●	●	●	●	●	●	●	●	●	●	●	●	●	●	●	●	
Hardened steel	H	●	●	●	●	●	●	●	●	●	●	●	●	●	●	●	●	●	

● Continuous cutting
 ● General cutting
 ● Interrupted cutting


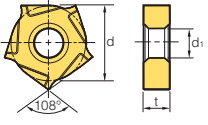
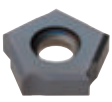
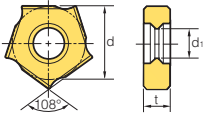

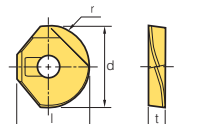

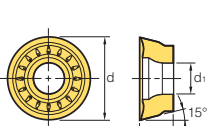

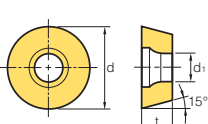
Inserts	Designation	Cermets		Coated							Uncoated	Dimensions (mm)								Geometries	Available tools					
		CN2500	CN30	NC5330	NCM325	NCM535	NCM545	PC2505	PC2010	PC3700	PC6510	PC9530	PC9540	PC5300	PC5400	ST30A	H01	l	d			t	r	d ₁	a	W
	05T3SN-MM			●					●	●							5.2	12.7	3.97	0.5	4.4	-	-	-		E62 E63
	05T308SN-MM								●								5.2	12.7	3.97	0.8	4.4	-	-	-		
	0704SN-MM									●							7.4	18	4.76	0.5	5.5	-	-	-		
	060608-MF									●							6.6	16.0	6.0	0.8	5.6	-	-	-		E143 E144
	080608-MF									●							8.4	20.2	6.0	0.8	5.6	-	-	-		
	0606ANN-MF									●							6.6	16.0	6.0	0.8	5.6	1.03	-	-		
	0806ANN-MF									●							8.4	20.2	6.0	0.8	5.6	1.53	-	-		
	060608-ML																6.6	16.0	6.0	0.8	5.6	-	-	-		E143 E144
	080608-ML																8.4	20.2	6.0	0.8	5.6	-	-	-		
	060608-MM									●							6.6	16.0	6.0	0.8	5.6	-	-	-		E143 E144
	080608-MM									●							8.4	20.2	6.0	0.8	5.6	-	-	-		
	0606ANN-MM									●							6.6	16.0	6.0	0.8	5.6	1.03	-	-		
	0806ANN-MM									●							8.4	20.2	6.0	0.8	5.6	1.53	-	-		
	060608-MA														●	6.6	16.0	6.0	0.8	5.6	-	-	-		E143 E144	
	080608-MA														●	8.4	20.2	6.0	0.8	5.6	-	-	-			
	060608-W									●	●	●					6.5	16.0	6.0	0.8	5.6	-	-	-		E143 E144
	080608-W									●	●	●					8.2	20.2	6.0	0.8	5.6	-	-	-		
	060608-MF				●					●							6.6	16.0	6.0	0.8	5.6	-	-	-		E143 E144
	080608-MF				●					●							8.4	20.2	6.0	0.8	5.6	-	-	-		
	0606ANN-MF				●					●	●	●					6.6	16.0	6.0	0.8	5.6	1.03	-	-		
	0806ANN-MF				●					●	●	●					8.4	20.2	6.0	0.8	5.6	1.53	-	-		
	060608-MM				●					●	●	●	●				6.6	16.0	6.0	0.8	5.6	-	-	-		E143 E144
	080608-MM				●					●	●	●	●				8.4	20.2	6.0	0.8	5.6	-	-	-		
	0606ANN-MM				●					●	●	●	●				6.6	16.0	6.0	0.8	5.6	1.03	-	-		
	0806ANN-MM				●					●	●	●	●				8.4	20.2	6.0	0.8	5.6	1.53	-	-		
	265																10	7	3.0	0.3	3.5	-	2.65	2.8		E365
	325									●							10	7	3.0	0.3	3.5	-	3.25	2.8		
	405																15	12	4.5	0.5	4.5	-	4.05	4.5		
	470									●							15	12	4.5	0.5	4.5	-	4.70	4.5		

● : Stock item



E Milling Inserts

Workpiece	Steel	P	●	●	●	●	●	●	●	●	●	●	●	Machining types
	Stainless steel	M	●	●	●	●	●	●	●	●	●	●	●	
Cast iron	K	●	●	●	●	●	●	●	●	●	●	●	●	<ul style="list-style-type: none"> ● Continuous cutting ● General cutting ● Interrupted cutting
Non-ferrous metal	N	●	●	●	●	●	●	●	●	●	●	●		
Heat resistant alloy, Titanium alloy	S	●	●	●	●	●	●	●	●	●	●	●		
Hardened steel	H	●	●	●	●	●	●	●	●	●	●	●		


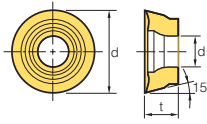

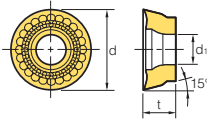

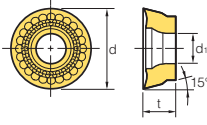

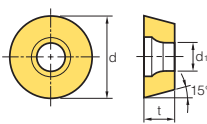

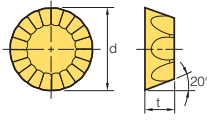

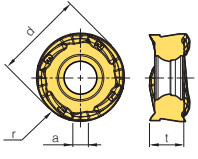

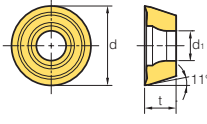
Inserts	Designation	Cermets		Coated							Uncoated	Dimensions (mm)						Geometries	Available tools							
		CN2500	CN30	NC5330	NCM535	NCM545	PC2505	PC2010	PC210F	PC3700	PC6510	PC9530	PC9540	PC5300	PC5400	ST30A	H01			l	d	t	r	d _i	Cutter width	
	1223N								●								-	12.7	2.3	-	5.0	4.0		E411 E412		
	1225N								●								-	12.7	2.5	-	5.0	4.5				
	1230N																	-	12.7	3.0	-	5.0			5.0	
	1235N									●								-	12.7	3.5	-	5.0			6.0	
	1240N									●				●				-	12.7	4.0	-	5.0			7.0	
	1245N									●				●				-	12.7	4.5	-	5.0			8.0	
	1250N													●				-	12.7	5.0	-	5.0			9.0	
	1255N									●								-	12.7	5.5	-	5.0			10.0	
	1260N																	-	12.7	6.0	-	5.0			11.0	
	1265N													●				-	12.7	6.5	-	5.0			12.0	
	1270N														●			-	12.7	7.0	-	5.0			13.0	
	1275N														●			-	12.7	7.5	-	5.0			14.0	
	1285N																	-	12.7	8.5	-	5.0			16.0	
		1223N-C03																-	12.7	2.3	-	5.0			4.0	
1230N-C03																		-	12.7	3.0	-	5.0	5.0			
1235N-C03																		-	12.7	3.5	-	5.0	6.0			
1240N-C05																		-	12.7	4.0	-	5.0	7.0			
1245N-C05																		-	12.7	4.5	-	5.0	8.0			
1250N-C05																		-	12.7	5.0	-	5.0	9.0			
1255N-C05																		-	12.7	5.5	-	5.0	10.0			
1260N-C05																		-	12.7	6.0	-	5.0	11.0			
1265N-C05																		-	12.7	6.5	-	5.0	12.0			
1270N-C05																		-	12.7	7.0	-	5.0	13.0			
1275N-C05																	-	12.7	7.5	-	5.0	14.0				
	16								●								15.8	16	3.5	8	-	-		E331		
	20								●								17.8	20	4	10	-	-				
	25									●								22.0	25	5	12.5	-			-	
	30										●							26.8	30	6	15	-			-	
	32										●							27.8	32	6	16	-			-	
	10T3M0-MA																●	-	10	3.97	-	3.85	-		E228 E229	
	1204M0-MA																	●	-	12	4.76	-	4.5			-
	0501M0F																	-	5	1.59	-	2.3	-		E230~ E233 E236~ E241	
	0501M0E																		-	5	1.59	-	2.3			-
	0501M0S																		-	5	1.59	-	2.3			-
	06T1M0F																		-	6	1.98	-	2.5			-
	06T1M0E																		-	6	1.98	-	2.5			-
	06T1M0S																		-	6	1.98	-	2.5			-
	0702M0F																		-	7	2.38	-	2.8			-
	0702M0E																		-	7	2.38	-	2.8			-
	0702M0S																		-	7	2.38	-	2.8			-
	0803M0F																		-	8	3.18	-	3.4			-
	0803M0E																		-	8	3.18	-	3.4			-
	0803M0S																		-	8	3.18	-	3.4			-
	1605M0F																		-	16	5.56	-	5.5			-
	1605M0E																		-	16	5.56	-	5.5			-
1605M0S																		-	16	5.56	-	5.5	-			
2006M0F																		-	20	6.35	-	5.5	-			
2006M0E																		-	20	6.35	-	5.5	-			
2006M0S																		-	20	6.35	-	5.5	-			

● : Stock item



Workpiece	Steel	P											Machining types			
	Stainless steel	M														
Cast iron	K															
Non-ferrous metal	N															
Heat resistant alloy, Titanium alloy	S															
Hardened steel	H															


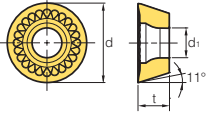

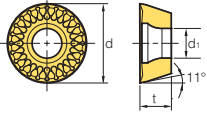

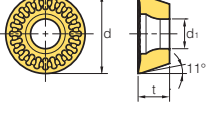

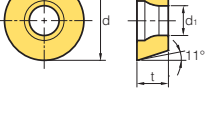


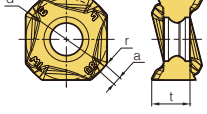

● Continuous cutting
 ● General cutting
 ✦ Interrupted cutting

Inserts	Designation	Cermet		Coated							Uncoated		Dimensions (mm)						Geometries	Available tools						
		CN2500	CN30	NC5330	NCM325	NCM535	NCM545	PC2505	PC2510	PC3700	PC6510	PC9530	PC9540	PC5300	PC5400	ST30A	H01	l			d	t	r	d _i	a	
RDKT-MF 	10T3M0-MF																-	10	3.97	-	3.85	-			E228~	
	1204M0-MF																	-	12	4.76	-	4.5	-			E230
	1605M0-MF																	-	16	5.56	-	5.5	-			E234~ E236 E240 E241
RDKT-ML 	1605M0-ML																-	16	5.56	-	5.5	-			E230 E236 E240 E241	
RDKT-MM 	10T3M0-MM				●				●	●	●	●					-	10	3.97	-	3.85	-			E228~	
	1204M0-MM				●				●	●	●	●						-	12	4.76	-	4.5	-			E231
	1605M0-MM								●	●	●	●						-	16	5.56	-	5.5	-			E234~ E237 E240 E241
	2006M0-MM								●	●	●	●						-	20	6.35	-	5.5	-			E237 E240 E241
RDKW 	0501M0E								●								-	5	1.59	-	2.3	-			E232	
	06T1M0E								●									-	6	1.98	-	2.5	-			E233
	0702M0E								●									-	7	2.38	-	2.8	-			E238
	0803M0E								●									-	8	3.18	-	3.4	-			E239
REKR-MM 	170400-MM																-	17.8	4.76	-	-	-			E63	
RNMX-ML 	1204M0E-ML																-	12.0	4.75	6.0	-	2.0			E145 E146	
RPCT-MA 	10T3M0-MA														●		-	10	3.97	-	4.0	-			E242~	
	1204M0-MA														●		-	12	4.76	-	4.5	-			E245	
	1606M0-MA														●		-	16	6.35	-	5.5	-			E247~	
	2007M0-MA														●		-	20	7.00	-	7.0	-			E253	

● : Stock item

E Milling Inserts


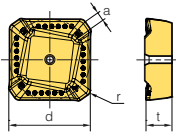

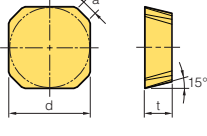

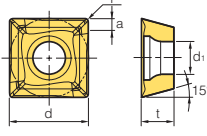

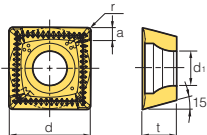

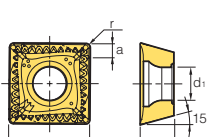

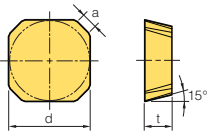
Workpiece	Steel	P											Machining types				
	Stainless steel	M													● Continuous cutting	⊕ General cutting	⊖ Interrupted cutting
Cast iron	K		●	●	●	●	●	●	●	●	●	●	●	●	●	●	●
Non-ferrous metal	N																●
Heat resistant alloy, Titanium alloy	S																●
Hardened steel	H																●

Inserts	Designation	Cermets		Coated							Uncoated		Dimensions (mm)						Geometries	Available tools						
		CN2500	CN30	NC5330	NCM325	NCM535	NCM545	PC2505	PC2510	PC3700	PC6510	PC9530	PC9540	PC5300	PC5400	ST30A	H01	l			d	t	r	d ₁	a	
RPMT-MF 	0803M0E-MF												●	●			-	8	3.18	-	3.4	-				E242~ E253
	10T3M0E-MF												●	●			-	10	3.97	-	4.0	-				
	1204M0E-MF												●	●			-	12	4.76	-	4.5	-				
	1606M0E-MF												●	●			-	16	6.35	-	5.5	-				
	2007M0E-MF												●	●			-	20	7.00	-	7.0	-				
RPMT-ML 	0803M0E-ML												●	●			-	8	3.18	-	3.4	-				E242~ E253
	10T3M0E-ML												●	●			-	10	3.97	-	4.0	-				
	1204M0E-ML												●	●			-	12	4.76	-	4.5	-				
	1606M0E-ML												●	●			-	16	6.35	-	5.5	-				
	2007M0E-ML												●	●			-	20	7.00	-	7.0	-				
RPMT-MM 	0803M0S-MM												●	●			-	8	3.18	-	3.4	-				E242~ E253
	10T3M0S-MM												●	●			-	10	3.97	-	4.0	-				
	1204M0S-MM												●	●			-	12	4.76	-	4.5	-				
	1606M0S-MM												●	●			-	16	6.35	-	5.5	-				
	2007M0S-MM												●	●			-	20	7.00	-	7.0	-				
RPMW 	0803M0E1												●	●			-	8	3.18	-	3.4	-				E242~ E253
	10T3M0E1												●	●			-	10	3.97	-	4.0	-				
	1204M0S1												●	●			-	12	4.76	-	4.5	-				
	1204M0S2												●	●			-	12	4.76	-	4.5	-				
	1606M0S1												●	●			-	16	6.35	-	5.5	-				
2007M0S1												●	●			-	20	7.00	-	7.0	-					
SAGX-ML 	140808ANER-ML												●	●			-	14	6.58	0.8	-	1.21				E141
SAGX-MM 	140808ANER-MM												●				-	14	6.58	0.8	-	1.21				E141
SNMX-MM 	140808ANER-MM												●	●	●		-	14	6.58	0.8	-	1.21				E141

● : Stock item



Workpiece	Steel	P											Machining types				
	Stainless steel	M	●	●	●	●	●	●	●	●	●	●	●	●	●	●	●
Cast iron	K																
Non-ferrous metal	N																
Heat resistant alloy, Titanium alloy	S																
Hardened steel	H																

Inserts	Designation	Cermets		Coated							Uncoated				Dimensions (mm)						Geometries	Available tools			
		CN2500	CN30	NCM325	NCM335	NCM535	NCM545	PC3700	PC6510	PC9530	PC9540	PC5300	PD1010	PD2000	ST30A	G10	H01	H05	l	d			t	r	d ₁
SCKN 	220715DDSR-MM					●		●										-	22.0	7.0	1.5	-	2.5		E58
	280920DDSR-MM																	-	28.0	9.0	2.0	-	3.0		
SDCN 	42M													●				-	12.7	3.18	-	-	1.5		E47 E48 E59 E60
	42M-G													●				-	12.7	3.18	-	-	1.5		
	42MT	●	●		●									●				-	12.7	3.18	-	-	1.5		
	42MT-RH																	-	12.7	3.18	-	-	1.5		
	42MT-S20																	-	12.7	3.18	-	-	1.5		
	53M													●				-	15.875	4.76	-	-	1.5		
	53M-G													●				-	15.875	4.76	-	-	1.5		
	53MT	●	●											●				-	15.875	4.76	-	-	1.5		
	53MT-RH																	-	15.875	4.76	-	-	1.5		
	53MT-S20																	-	15.875	4.76	-	-	1.5		
	1203AEEN																	-	12.7	3.18	-	-	1.5		
	1203AEEN-RH																	-	12.7	3.18	-	-	1.43		
	1203AESN																	-	12.7	3.18	-	-	1.5		
	1203AESN-RH																	-	12.7	3.18	-	-	1.43		
1504AEEN																	-	15.875	4.76	-	-	1.5			
1504AEEN-RH																	-	15.875	4.76	-	-	1.43			
1504AESN																	-	15.875	4.76	-	-	1.5			
1504AESN-RH																	-	15.875	4.76	-	-	1.43			
SDET-MA 	09M402R-MA													●	●	●	-	9.525	3.923	0.2	4.0	1.2		E222~ E227	
	09M404R-MA																-	9.525	3.923	0.4	4.0	1.2			
	09M405R-MA																-	9.525	3.923	0.5	4.0	1.2			
	130504R-MA														●	●	●	-	13.5	5.56	0.4	5.56			2.2
SDET-MF 	09M405R-MF																-	9.525	4	0.5	4	1.2		E222~ E227	
	130508R-MF																-	13.5	5.56	0.8	5.56	2.2			
SDET-MM 	09M405R-MM																-	9.525	4	0.5	4	1.2		E222~ E227	
	130508R-MM																-	13.5	5.56	0.8	5.56	2.2			
SDKN-CM 	42MT-CM	●															-	12.7	3.18	-	-	1.5		-	

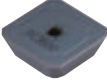
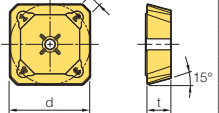
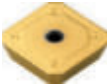
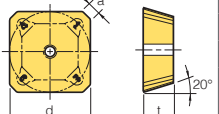

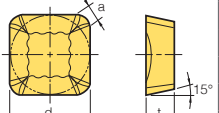
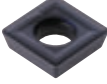
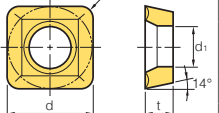

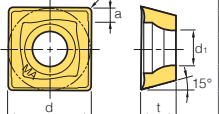
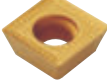
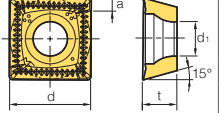

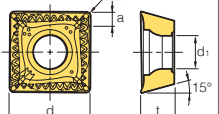

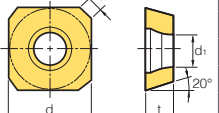
● : Stock item



E Milling Inserts

Workpiece	Steel	P											Machining types		
	Stainless steel	M													
Cast iron	K														
Non-ferrous metal	N														
Heat resistant alloy, Titanium alloy	S														
Hardened steel	H														


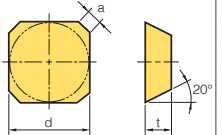

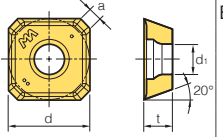
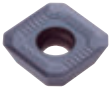
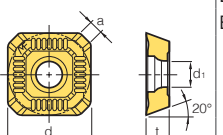

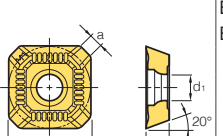

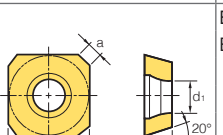

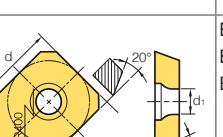

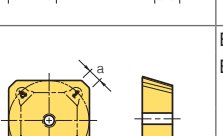
● Continuous cutting
 ● General cutting
 ✦ Interrupted cutting

Inserts	Designation	Cermet		Coated							Uncoated		Dimensions (mm)						Geometries	Available tools				
		CN2500	CN30	NC5330	NCM325	NCM335	NCM535	NCM545	PC3700	PC6510	PC9530	PC9540	PC5300	PC5400	ST30A	H01	H05	l			d	t	r	d ₁
SDKN-MU 	1203AESN-MU								●								-	12.7	3.18	-	-	2.08		E47
	1504AESN-MU								●								-	15.875	4.76	-	-	2.10		E48 E53 E54
SDKN-SU 	1203AESN-SU								●				●	●			-	12.7	3.18	-	-	2.08		E47
	1504AESN-SU								●				●	●			-	15.875	4.76	-	-	2.10		E48 E53 E54
SDKR-MX 	1203AESN-MX																-	12.7	3.18	-	-	1.46		E47
	1203AETN-MX																-	12.7	3.18	-	-	1.46		E48
	1203AEN-MX				●												-	12.7	3.18	-	-	1.46		E53
	1504AESN-MX					●											-	15.875	4.76	-	-	1.45		E54
	1504AETN-MX																-	15.875	4.76	-	-	1.45		
	1504AEN-MX				●												-	15.875	4.76	-	-	1.45		
SDMT-MM 	090308-MM								●				●				-	9.525	3.18	0.8	4.4	-		E307 E336
SDXT-MA 	09M405R-MA														●	●	-	9.525	4.0	0.5	4.0	1.2		E222~
	130508R-MA														●	●	-	13.5	5.56	0.8	5.56	2.2		E227
SDXT-MF 	09M403R-MF																-	9.525	4.0	0.3	4.0	1.2		E222~
	09M403L-MF																-	9.525	4.0	0.3	4.0	1.2		E227
	09M404R-MF																-	9.525	4.0	0.4	4.0	1.2		
	09M404L-MF																-	9.525	4.0	0.4	4.0	1.2		
	09M405R-MF				●					●	●	●	●	●			-	9.525	4.0	0.5	4.0	1.2		
	09M405L-MF																-	9.525	4.0	0.5	4.0	1.2		
	130508R-MF				●						●	●	●	●			-	13.5	5.56	0.8	5.56	2.2		
SDXT-MM 	09M405R-MM				●	●				●	●	●	●				-	9.525	4.0	0.5	4.0	1.2		E222~
	09M405L-MM																-	9.525	4.0	0.5	4.0	1.2		E227
	130508R-MM				●	●					●	●	●	●			-	13.5	5.56	0.8	5.56	2.2		
	130508L-MM																-	13.5	5.56	0.8	5.56	2.2		
	130538-MM																-	13.5	5.56	3.8	5.56	2.2		
SECA 	1204AFSN				●												-	12.7	4.76	-	5.56	2.66		-
	1204AFTN		●							●	●						-	12.7	4.76	-	5.56	2.66		
	1204AFFN																-	12.7	4.76	-	5.56	2.66		
	1204AFEN																-	12.7	4.76	-	5.56	2.66		
	1504AFSN																-	15.875	4.76	-	5.5	2.8		
	1504AFTN																-	15.875	4.76	-	5.5	2.8		
1504AFFN																-	15.875	4.76	-	5.5	2.8			

● : Stock item



Workpiece	Material		Machining types									
	Color	Symbol	●	⊙	⊚	⊛	⊜	⊝	⊞	⊟	⊠	⊡
Steel	P	●	●	●	●	●	●	●	●	●	●	●
Stainless steel	M	●	●	●	●	●	●	●	●	●	●	●
Cast iron	K	●	●	●	●	●	●	●	●	●	●	●
Non-ferrous metal	N	●	●	●	●	●	●	●	●	●	●	●
Heat resistant alloy, Titanium alloy	S	●	●	●	●	●	●	●	●	●	●	●
Hardened steel	H	●	●	●	●	●	●	●	●	●	●	●

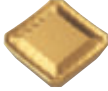
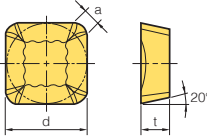
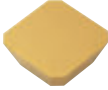
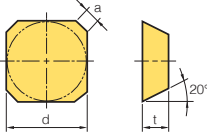
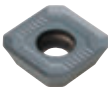
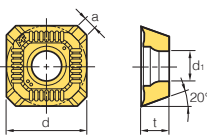
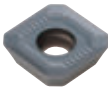
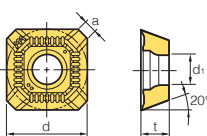
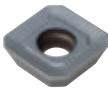
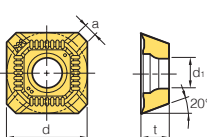

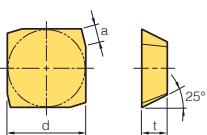

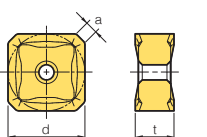

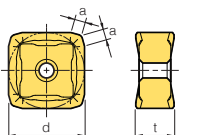
Inserts	Designation	Cermets		Coated							Uncoated			Dimensions (mm)						Geometries	Available tools		
		CN2500	CN30	NCM325	NCM335	PC3700	PC6510	PC9530	PC9540	PC5300	PD1010	PD2000	ST30A	G10	H01	H05	l	d	t			r	d ₁
SECN 	1203AFFN											●	●		-	12.7	3.18	-	-	-	2.36	 <p>► Shape of Edge - S20: STS - RH: Strengthened edge, STS</p>	E49 E50
	1203AFTN	●	●									●			-	12.7	3.18	-	-	-	2.36		
	1203AFEN														-	12.7	3.18	-	-	-	2.36		
	1203AFSN			●	●										-	12.7	3.18	-	-	-	2.36		
	1203AFEN-RH						●			●					-	12.7	3.18	-	-	-	2.36		
	1203AFSN-RH														-	12.7	3.18	-	-	-	2.36		
	1203AFTN-S20									●					-	12.7	3.18	-	-	-	2.36		
	1504AFFN												●		-	15.875	4.76	-	-	-	2.4		
	1504AFTN		●												-	15.875	4.76	-	-	-	2.4		
	1504AFEN														-	15.875	4.76	-	-	-	2.4		
	1504AFSN														-	15.875	4.76	-	-	-	2.4		
	1504AFEN-RH														-	15.875	4.76	-	-	-	2.4		
	1504AFSN-RH							●							-	15.875	4.76	-	-	-	2.4		
	1504AFTN-S20														-	15.875	4.76	-	-	-	2.4		
SEET-MA 	0903AGFN-MA												●	●	-	9.525	3.18	-	3.4	2.11		E216~ E221	
	14M4AGFN-MA												●	●	-	14.0	4.0	-	4.4	2.64			
SEET-MF 	0903AGSN-MF					●	●		●	●					-	9.525	3.18	-	3.4	2.11		E216~ E221	
	14M4AGSN-MF					●	●		●	●					-	14.0	4.0	-	4.4	2.64			
SEET-MM 	0903AGSN-MM			●		●			●	●					-	9.525	3.18	-	3.4	2.11		E216~ E221	
	14M4AGSN-MM			●	●	●	●		●	●					-	14.0	4.0	-	4.4	2.64			
SEEW 	0903AGTN														-	9.525	3.18	-	3.4	2.11		E216~ E221	
	14M4AGTN		●												-	14.0	4.0	-	4.4	2.64			
SEEW-W 	14M4AGFN-W														-	14.0	4.0	-	4.4	8.5		E217 E219 E221	
	14M4AGSN-W									●					-	14.0	4.0	-	4.4	8.5			
	14M4AGTN-W										●				-	14.0	4.0	-	4.4	8.5			
SEKN-SU 	1203AFSN-SU					●									-	12.7	3.18	-	-	1.98		E49 E50	
	1504AFSN-SU					●				●					-	15.875	4.76	-	-	2.04			

● : Stock item

E Milling Inserts

Workpiece	Steel	P											Machining types			
	Stainless steel	M														
	Cast iron	K														
	Non-ferrous metal	N														
	Heat resistant alloy, Titanium alloy	S														
Hardened steel	H															

● Continuous cutting
 ● General cutting
 ✦ Interrupted cutting


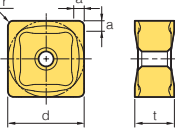

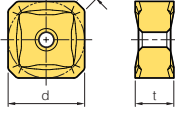

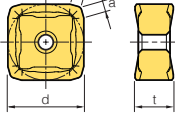

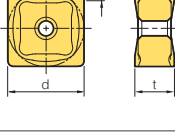

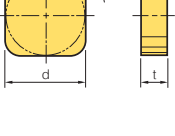

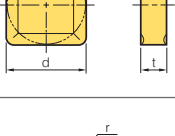

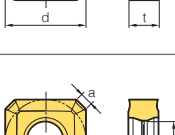
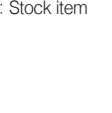

Inserts	Designation	Cermet		Coated							Uncoated	Dimensions (mm)					Geometries	Available tools				
		CN2500	CN30	NCM325	NCM335	NCM535	NCM545	PC2505	PC2010	PC3700	PC6510	PC9530	PC9540	PC5300	PC5400	ST30A			H01	l	d	t
SEKR-MX 	1203AFSN-MX			●	●						●					-	12.7	3.18	-	2.3		E49 E50
	1504AFSN-MX			●							●					-	15.875	4.76	-	2.4		
SEMN 	1204AZ															-	12.7	4.76	-	2.0		-
SEXT-MF 	0903AGSN-MF									●		●	●			-	9.525	3.18	3.4	2.11		E216~ E221
	14M4AGSN-MF									●		●	●			-	14.0	4.0	4.4	2.64		
SEXT-MM 	0903AGSN-MM									●	●	●	●			-	9.525	3.18	3.4	2.11		E216~ E221
	14M4AGSN-MM			●						●	●	●	●			-	14.0	4.0	4.4	2.64		
SEXT-MR 	0903AGSN-MR									●		●				-	9.525	3.18	3.4	2.11		E216~ E221
	14M4AGSN-MR									●		●				-	14.0	4.0	4.4	2.64		
SFCN 	1203EFR													●		-	12.7	3.18	-	2.5		E51
SNC(M)F-MF 	SNMF 1206ANN-MF															-	12.7	6.6	-	2.0		E136 E137
	SNMF 1507ANN-MF															-	15.875	7.35	-	2.1		
	SNCF 1206ANN-MF										●					-	12.7	6.6	-	2.0		
	SNCF 1507ANN-MF										●					-	15.875	7.35	-	2.1		
SNC(M)F-MM 	SNMF 1206ENN-MF									●						-	12.7	6.6	-	1.8		E138 E139
	SNMF 1507ENN-MF									●						-	15.875	7.35	-	1.8		
	SNCF 1206ENN-MF										●					-	12.7	6.6	-	1.8		
	SNCF 1507ENN-MF										●					-	15.875	7.35	-	1.8		

● : Stock item



Workpiece	Steel	P												Machining types		
	Stainless steel	M														
Cast iron	K															
Non-ferrous metal	N															
Heat resistant alloy, Titanium alloy	S															
Hardened steel	H															

● Continuous cutting
 ◐ General cutting
 ✖ Interrupted cutting

Inserts	Designation	Cermets		Coated								Uncoated		Dimensions (mm)							Geometries	Available tools			
		CN2500	CN30	NC5330	NCM325	NCM535	NCM545	PC2505	PC2010	PC3700	PC6510	PC9530	PC9540	PC5300	PC5400	ST30A	H01	l	d	t			r	d ₁	a
	SNMF 1206QNN-MF									●							-	12.7	6.6	0.8	-	1	-		E140
	SNCF 1206QNN-MF									●							-	12.7	6.6	0.8	-	1	-		
	SNMF 1206ANN-MM																-	12.7	6.6	-	-	2	-		E136
	1507ANN-MM																-	15.875	7.35	-	-	2.1	-		
	SNCF 1206ANN-MM																-	12.7	6.6	-	-	2	-		
	1507ANN-MM																-	15.875	7.35	-	-	2.1	-		
	SNMF 1206ENN-MM									●							-	12.7	6.6	-	-	1.8	-		E138
	1507ENN-MM									●							-	15.875	7.35	-	-	1.8	-		
	SNCF 1206ENN-MM																-	12.7	6.6	-	-	1.8	-		
	1507ENN-MM																-	15.875	7.35	-	-	1.8	-		
	SNMF 1206QNN-MM									●							-	12.7	6.6	0.8	-	1	-		E140
	SNCF 1206QNN-MM									●							-	12.7	6.6	0.8	-	1	-		
	1204ENN			●											●		-	12.7	4.76	-	-	1.4	1.0		E52
	1504ENN																-	15.875	4.76	-	-	1.4	1.0		
	435									●							-	12.7	4.76	2.0	-	-	-		-
	535																-	15.875	4.76	2.0	-	-	-		
	120420-MF									●							-	12.7	4.76	2.0	5.7	(2.3)	-		E423
	1204ANN-MF																-	12.7	4.76	-	5.7	(2.0)	-		E423

● : Stock item

E Milling Inserts







Workpiece	Material	Color	Machining types											
			●	◐	◑	◒	◅	◄	◅	◄	◅	◄	◅	◄
Steel	P	Blue	●	◐	◑	◒	◅	◄	◅	◄	◅	◄	◅	◄
Stainless steel	M	Yellow	◐	◑	◒	◅	◄	◅	◄	◅	◄	◅	◄	◅
Cast iron	K	Red	◐	◑	◒	◅	◄	◅	◄	◅	◄	◅	◄	◅
Non-ferrous metal	N	Green	◐	◑	◒	◅	◄	◅	◄	◅	◄	◅	◄	◅
Heat resistant alloy, Titanium alloy	S	Orange	◐	◑	◒	◅	◄	◅	◄	◅	◄	◅	◄	◅
Hardened steel	H	Grey	◐	◑	◒	◅	◄	◅	◄	◅	◄	◅	◄	◅

Inserts	Designation	Material										Dimensions (mm)						Geometries	Available tools							
		Cermet		Coated						PCD		l	d	t	r	d ₁	a									
		CN2500	CN30	NC5330	NCM535	NCM545	PC2505	PC2010	PC3700	PC6510	PC9530							PC9540	PC5300	PC5400	H01	DP150	DP200			
SNEU-TBW 	1204-TBW																		-	12.7	4.76	-	5.7	(2.1)		E423
																			-	12.7	4.76	-	5.7	-		E423
SNEU-WMF 	1204R-WMF																		-	12.7	4.76	-	5.7	-		E423
																			-	10	10	1.0	4.6	-		-
SNEX 	101010									●									-	10	10	1.0	4.6	-		-
	1010ZNN									●									-	10	10	(1.0)	4.6	-		-
SNEX-CU1 	101010-CU1									●									-	10	10	1.0	4.6	-		-
	1010ZNN-CU1									●									-	10	10	(1.0)	4.6	-		-
	121212-CU1									●									-	12.7	12.7	1.2	5.6	-		-
	1212ZNN-CU1									●									-	12.7	12.7	(1.2)	5.6	-		-
SNEX-MA 	1206ANN-MA													●					-	12.7	6.35	-	4.5	2.36		E126
	1206ENN-MA													●					-	12.7	6.35	-	5.2	1.82		E127
	1206QNN-MA													●					-	12.7	6.35	-	5.2	1.39		E130
	120612-MA													●					-	12.7	6.35	1.2	5.2	-		E131 E134 E135
SNEX-ML 	1206ANN-ML													●	●				-	12.7	6.35	-	4.5	2.36		E126~
	1206ENN-ML													●	●				-	12.7	6.35	-	5.2	1.82		E135
	1206QNN-ML													●	●				-	12.7	6.35	-	5.2	1.39		E135
	120612-ML													●	●				-	12.7	6.35	1.2	5.2	-		E135
	1507ANN-ML													●	●				-	15.875	7.94	-	5.6	3.16		-
	1507ENN-ML													●	●				-	15.875	7.94	-	5.6	2.66		-
SNEW 	09T3ADFR													●					9.525	9.525	3.97	-	4.4	-		E154 E155
														●					9.525	9.525	3.97	-	4.4	-		E154 E155
SNEW-NAF 	09T3ADTR-NAF													●					9.525	9.525	3.97	-	4.4	-		E154
	09T3ADTR-NAW													●					9.525	9.525	3.97	-	4.4	-		E155
	NAW: Wiper insert																									-
SNEW-XAF 	09T3ADTR-XAF													●					9.525	9.525	3.97	-	4.4	-		E154
	09T3ADTR-XAW													●					9.525	9.525	3.97	-	4.4	-		E155
	XAW: Wiper insert																									-

● : Stock item



Workpiece	Machining types									
	P	M	K	N	S	H	●	⊕	⊛	⊚
Steel	●	●	●	●	●	●	●	●	●	●
Stainless steel	●	●	●	●	●	●	●	●	●	●
Cast iron	●	●	●	●	●	●	●	●	●	●
Non-ferrous metal	●	●	●	●	●	●	●	●	●	●
Heat resistant alloy, Titanium alloy	●	●	●	●	●	●	●	●	●	●
Hardened steel	●	●	●	●	●	●	●	●	●	●

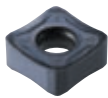
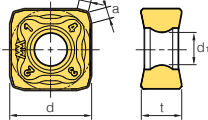
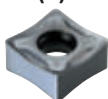
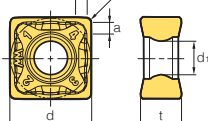

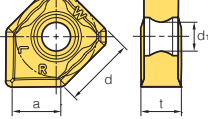

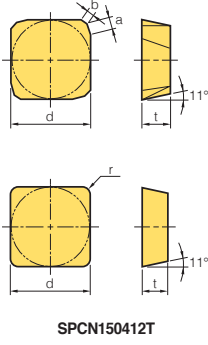

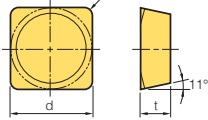

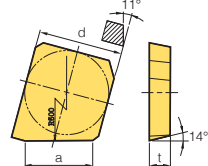

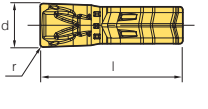
Inserts	Designation	Cermets		Coated						PCD		Dimensions (mm)						Geometries	Available tools				
		CN2500	CN30	NC5330	NCM535	NCM545	PC2010	PC3700	PC6510	PC9530	PC9540	PC5300	PC5400	DP150	DP200	l	d			t	r	d ₁	a
SNHT-WX 	1102308R-WX									●				-	11	2.30	-	4	-	-			
	110308R-WX									●				-	11	3.00	-	4	-	-			
	1203508R-WX									●				-	12.7	3.50	-	5	-	-			
	120408R-WX									●				-	12.7	4.00	-	5	-	-			
	1204508R-WX									●				-	12.7	4.54	-	5	-	-			
	120508R-WX									●				-	12.7	5.00	-	5	-	-			
	1205408R-WX									●				-	12.7	5.47	-	5	-	-			
	120608R-WX									●				-	12.7	6.00	-	5	-	-			
	1206508R-WX									●				-	12.7	6.50	-	5	-	-			
	120708R-WX									●				-	12.7	7.00	-	5	-	-			
	1207508R-WX									●				-	12.7	7.5	-	5	-	-			
	1102308L-WX										●				-	11	2.30	-	4	-	-		
	110308L-WX										●				-	11	3.00	-	4	-	-		
	120308L-WX										●				-	12.7	3.25	-	5	-	-		
	1203508L-WX										●				-	12.7	3.50	-	5	-	-		
	120408L-WX										●				-	12.7	4.00	-	5	-	-		
	1204508L-WX										●				-	12.7	4.54	-	5	-	-		
	120508L-WX										●				-	12.7	5.00	-	5	-	-		
	1205408L-WX										●				-	12.7	5.47	-	5	-	-		
	120608L-WX										●				-	12.7	6.00	-	5	-	-		
1206508L-WX										●				-	12.7	6.50	-	5	-	-			
120708L-WX										●				-	12.7	7.00	-	5	-	-			
1207508L-WX										●				-	12.7	7.5	-	5	-	-			
SNKN 	1204ENN									●				-	12.7	4.76	-	-	1.4	1.0			
	1504ENN									●				-	15.875	4.76	-	-	1.4	1.0			
SNM(E)X-MF 	SNMX 1206ANN-MF				●		●	●	●	●	●			-	12.7	6.35	-	4.5	2.36	-			
	1507ANN-MF				●		●	●	●	●	●			-	15.875	7.94	-	5.6	3.15	-			
	SNEX 1206ANN-MF							●	●	●	●	●		-	12.7	6.35	-	4.5	2.36	-			
	1507ANN-MF								●	●	●	●		-	15.875	7.94	-	5.6	3.15	-			
SNM(E)X-MF 	SNMX 1206ENN-MF				●		●	●	●	●	●			-	12.7	6.35	-	5.2	1.82	-			
	1507ENN-MF				●		●	●	●	●	●			-	15.875	7.94	-	5.6	2.66	-			
	SNEX 1206ENN-MF								●	●	●	●		-	12.7	6.35	-	5.2	1.82	-			
	1507ENN-MF									●	●	●		-	15.875	7.94	-	5.6	2.66	-			
SNM(E)X-MF 	SNMX 1206QNN-MF				●		●	●	●	●	●			-	12.7	6.35	-	5.2	2.36	-			
	120612-MF								●	●	●	●		-	12.7	6.35	1.2	5.2	-	-			
	SNEX 1206QNN-MF								●	●	●	●		-	12.7	6.35	-	5.2	2.36	-			
	120612-MF									●	●	●		-	12.7	6.35	1.2	5.2	-	-			
SNM(E)X-MM 	SNMX 1206ANN-MM				●	●		●	●	●	●	●		-	12.7	6.35	-	4.5	2.36	-			
	1507ANN-MM				●			●	●	●	●	●		-	15.875	7.94	-	5.6	3.15	-			
	SNEX 1206ANN-MM								●	●	●	●	●	-	12.7	6.35	-	4.5	2.36	-			
	1507ANN-MM									●	●	●		-	15.875	7.94	-	5.6	3.15	-			

● : Stock item



E Milling Inserts

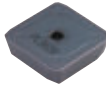
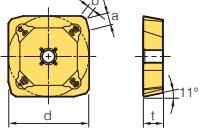
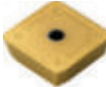
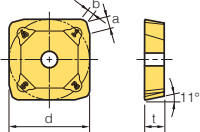

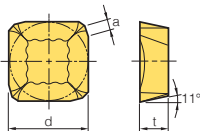
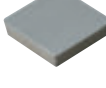
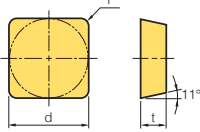

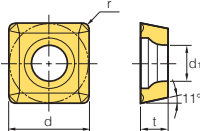

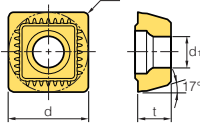

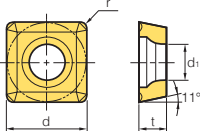

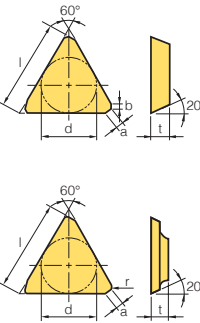

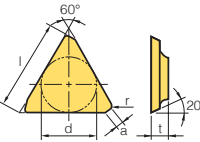
Workpiece	Steel	P											Machining types	
	Stainless steel	M											● Continuous cutting	
	Cast iron	K											⊕ General cutting	
	Non-ferrous metal	N											⊕ Interrupted cutting	
	Heat resistant alloy, Titanium alloy	S												
Hardened steel	H													

Inserts	Designation	Cermets		Coated							Uncoated			Dimensions (mm)							Geometries	Available tools					
		CN2500	CN30	NCM325	NCM335	NCM535	NCM545	PC3700	PC6510	PC9530	PC9540	PC5300	PC5400	ST30A	G10	H01	l	d	t	r			d ₁	a	b		
	SNMX 1206ENN-MM					●	●	●	●	●	●	●				-	12.7	6.35	-	5.2	1.82	-					E130~ E133
	1507ENN-MM					●	●	●	●	●	●	●				-	15.875	7.94	-	5.6	2.66	-					
	SNEX 1206ENN-MM															-	12.7	6.35	-	5.2	1.82	-					
	1507ENN-MM															-	15.875	7.94	-	5.6	2.66	-					
	SNMX 1206QNN-MM					●	●	●	●	●	●	●				-	12.7	6.35	-	5.2	2.36	-				E134 E135	
	120612-MM															-	12.7	6.35	1.2	5.2	-	-					
	SNEX 1206QNN-MM															-	12.7	6.35	-	5.2	2.36	-					
	120612-MM															-	12.7	6.35	1.2	5.2	-	-					
	1206ANN-W									●	●		●			-	12.7	6.35	-	4.5	7.6	-				E126 E127	
	1203EDR			●	●	●								●	●		-	12.7	3.18	-	-	1.4	1.0			E53 E54	
	1203EDR-RH																-	12.7	3.18	-	-	1.4	1.0				
	1203EDL														●		-	12.7	3.18	-	-	1.4	1.0				
	1203EDR-G														●		-	12.7	3.18	-	-	1.4	1.0				
	1203EDR-RN																-	12.7	3.18	-	-	1.4	1.0				
	1203EDER-RH															●	-	12.7	3.18	-	-	1.63	0.8				
	1203EDSR-RH															●	-	12.7	3.18	-	-	1.63	0.8				
	1203EDTR-RH																-	12.7	3.18	-	-	1.63	0.8				
	1203EDR-S20															●	-	12.7	3.18	-	-	1.4	1.0				
	150412T																-	15.875	4.76	1.2	-	-	-				
	1504EDR			●	●									●	●		-	15.875	4.76	-	-	1.4	1.0				
	1504EDR-RH																-	15.875	4.76	-	-	1.4	1.0				
	1504EDSR																-	15.875	4.76	-	-	1.4	1.0				
	1504EDL															●	-	15.875	4.76	-	-	1.4	1.0				
	1504EDR-G														●		-	15.875	4.76	-	-	1.4	1.0				
	1504EDR-RN			●													-	15.875	4.76	-	-	1.4	1.0				
	1504EDER-RH																●	-	15.875	4.76	-	-	1.64	0.8			
	1504EDSR-RH																●	-	15.875	4.76	-	-	1.64	0.8			
1504EDTR-RH																	-	15.875	4.76	-	-	1.64	0.8				
1504EDR-S20															●	-	15.875	4.76	-	-	1.4	1.0					
	120416-WC															-	12.7	4.76	1.6	-	-	-					
	150412-WC															-	15.875	4.76	1.2	-	-	-					
	150416-WC															-	15.875	4.76	1.6	-	-	-					
	150420-WC															-	15.875	4.76	2.0	-	-	-					
	190424-WC															-	19.05	4.76	2.4	-	-	-					
	1203EDR-1															-	12.7	3.18	-	-	10.2	-			E53 E54		
	1203EDL-1															-	12.7	3.18	-	-	10.2	-					
	1504EDR-1															-	15.875	4.76	-	-	10.2	-					
	1504EDL-1															-	15.875	4.76	-	-	10.2	-					
	200-N															8.8	2.2	-	0.2	-	-	-			E413		
	300-N															9.8	3.0	-	0.2	-	-	-					
	400-N															9.8	4.0	-	0.25	-	-	-					

● : Stock item



Workpiece	Steel	P	●	●	●	●	●	●	●	●	●	●	●	●	●	Machining types	
	Stainless steel	M			●	●	●	●	●	●	●	●	●	●	●		● Continuous cutting
	Cast iron	K			●											● General cutting	
	Non-ferrous metal	N														● Interrupted cutting	
	Heat resistant alloy, Titanium alloy	S															
Hardened steel	H																

Inserts	Designation	Cermets		Coated							Uncoated			Dimensions (mm)						Geometries	Available tools				
		CN2500	CN30	NC5330	NCM325	NCM335	NCM535	NCM545	PC3700	PC6510	PC9530	PC9540	PC5300	PC5400	ST30A	G10	H01	l	d			t	r	d ₁	a
	1203EDSR-MU								●								-	12.7	3.18	-	-	0.86	1.87		E53
	1504EDSR-MU								●								-	15.875	4.76	-	-	0.84	1.92		E54
	1203EDSR-SU								●				●	●			-	12.7	3.18	-	-	1.66	0.92		E53
	1203EDSL-SU								●				●	●			-	12.7	3.18	-	-	1.66	0.92		E54
	1504EDSR-SU								●				●	●			-	15.875	4.76	-	-	1.62	0.93		
	1504EDSL-SU								●				●	●			-	15.875	4.76	-	-	1.62	0.93		
	1203EDSR-MX				●	●											-	12.7	3.18	-	-	1.4	-		E53
	1203EDSL-MX																-	12.7	3.18	-	-	1.4	-		E54
	1504EDR-MX				●												-	15.875	4.76	-	-	1.45	-		
	1504EDSR-MX																-	15.875	4.76	-	-	1.45	-		
	120308												●				-	12.7	3.18	0.8	-	-	-		E369
	060304				●												-	6.35	3.18	0.4	2.8	-	-		E307 E334 E335
	110408-KC								●				●	●			-	11.5	4.8	0.8	4.5	-	-		E369
	120408-MM								●				●				-	12.7	4.76	0.8	5.6	-	-		E307
	120508-MMN																-	12.7	5.56	0.8	5.6	-	-		E334 E336 E352
	TECN 22R																11.0	6.35	3.18	-	-	1.0	0.5		E61
	22TR				●								●				11.0	6.35	3.18	0.8	-	0.5	-		
	32R																16.5	9.525	3.18	-	-	1.0	0.5		
	32R-G																16.5	9.525	3.18	-	-	1.0	0.5		
	32TR				●	●							●				16.5	9.525	3.18	0.8	-	0.5	-		
	32TR-S20																16.5	9.525	3.18	0.8	-	0.5	-		
	43R-G																22.0	12.7	4.76	-	-	2.0	0.5		
	43TR-Z																22.0	12.7	4.76	0.8	-	1.5	-		
43TR																22.0	12.7	4.76	0.8	-	1.5	-			
TEEN 32TR																16.5	9.525	3.18	0.8	-	0.5	-			
	43R-Z															22.0	12.7	4.76	-	-	2.0	0.5		E61	
	43TR-Z												●			22.0	12.7	4.76	0.8	-	1.5	-			
	43TR-ZH															22.0	12.7	4.76	0.8	-	1.5	-			
	43R															22.0	12.7	4.76	-	-	2.0	0.5			
	43R-G												●			22.0	12.7	4.76	-	-	2.0	0.5			
	43TR				●	●				●			●			22.0	12.7	4.76	0.8	-	1.5	-			
43TR-S20															22.0	12.7	4.76	0.8	-	1.5	-				

● : Stock item


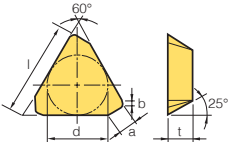

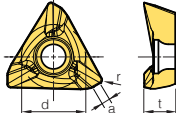

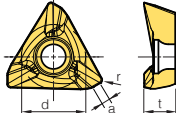

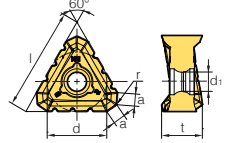

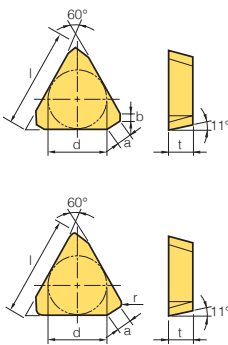
► Shape of Edge
 - G: Light side, Sharp edge
 - S20: STS
 - ZH: Hole added



E Milling Inserts

Workpiece	Steel	P	●	●	●	●	●	●	●	●	●	●	●	●	●	●	Machining types
	Stainless steel	M															
	Cast iron	K															
	Non-ferrous metal	N															
	Heat resistant alloy, Titanium alloy	S															
Hardened steel	H																

● Continuous cutting
 ● General cutting
 ✱ Interrupted cutting

Inserts	Designation	Cermets		Coated								Uncoated		Dimensions (mm)							Geometries	Available tools		
		CN2500	CN30	NC5330	NCM325	NCM335	NCM535	NCM545	PC3700	PC6510	PC9530	PC9540	PC5300	PC5400	ST30A	G10	H01	l	d	t			r	d ₁
TFCN 	2203PFR														●	22.0	12.7	3.18	-	-	2.42	0.71		E55
	2203PFL															22.0	12.7	3.18	-	-	2.42	0.71		
TNKT-ML 	110508PEER-ML															-	8.0	4.500	0.8	-	1.3	-		E258~ E261
	160608PEER-ML															-	11.7	5.500	0.8	-	1.5	-		
	200708PEER-ML															-	14.5	7.000	0.8	-	2.0	-		
TNKT-MM 	110508PESR-MM															-	8.0	4.531	0.8	-	1.3	-		E258~ E261
	160608PESR-MM															-	11.7	5.531	0.8	-	1.5	-		
	200708PESR-MM															-	14.5	7.031	0.8	-	2.0	-		
TNMX-NM 	2710AZNR-NM			●												27	15.875	10	0.8	5.6	2.63	-		E68~ E70
	2710AZNL-NM															27	15.875	10	0.8	5.6	2.63	-		
	3012PNR-NM															30	17.462	11.970	0.8	5.6	3.5	-		
TPCN 	1103PPN		●												●	11.0	6.35	3.18	-	-	0.7	0.7		E56
	1103PPTN															11.0	6.35	3.18	-	-	0.7	0.7		
	1603PDR				●											16.5	9.525	3.18	-	-	1.2	0.7		
	1603PPN		●	●											●	16.5	9.525	3.18	-	-	1.2	1.2		
	1603PPR		●	●											●	16.5	9.525	3.18	-	-	1.2	1.0		
	1603PPR-RH															16.5	9.525	3.18	-	-	1.2	1.0		
	1603PPR-G														●	16.5	9.525	3.18	-	-	1.2	1.0		
	1603PPSR															16.5	9.525	3.18	-	-	1.2	1.0		
	1603PPTN															16.5	9.525	3.18	-	-	1.2	1.2		
	1603PPTR															16.5	9.525	3.18	-	-	1.2	1.0		
	1603PPTR-RH															16.5	9.525	3.18	-	-	1.2	1.0		
	1603PDER-RH															16.5	9.525	3.18	0.8	-	1.5	-		
	1603PDSR-RH															16.5	9.525	3.18	0.8	-	1.5	-		
	1603PDR-S20															16.5	9.525	3.18	-	-	1.2	0.7		
	1603PDR-RN															16.5	9.525	3.18	-	-	1.5	1.1		
	2204PDR		●	●												22.0	12.7	4.76	-	-	1.4	0.7		
	2204PDR-RH															22.0	12.7	4.76	-	-	1.4	0.7		
	2204PDR-RN															22.0	12.7	4.76	-	-	1.42	0.52		
	2204PDR-G														●	22.0	12.7	4.76	-	-	1.4	0.7		
	2204PDL														●	22.0	12.7	4.76	-	-	1.4	0.7		
	2204PDSR					●										22.0	12.7	4.76	-	-	1.4	0.7		
	2204PDTR															22.0	12.7	4.76	-	-	1.4	0.7		
	2204PPN															22.0	12.7	4.76	-	-	1.2	1.2		
2204PPTN															22.0	12.7	4.76	-	-	1.2	1.2			
2204PDR-RH															22.0	12.7	4.76	0.8	-	1.8	-			
2204PDER-RH															22.0	12.7	4.76	0.8	-	1.8	-			
2204PDSR-RH															22.0	12.7	4.76	0.8	-	1.8	-			
2204PDR-S20															22.0	12.7	4.76	-	-	1.4	0.7			








※ In this page, TPC(K)N □□□□P-N is for FC·HC and □□□□P~R is for Cutter (face).

● : Stock item



Workpiece	Steel	P												Machining types					
	Stainless steel	M	●	●	●	●	●	●	●	●	●	●	●				●	●	●
Cast iron	K																		
Non-ferrous metal	N																		
Heat resistant alloy, Titanium alloy	S																		
Hardened steel	H																		

● Continuous cutting
 ● General cutting
 ● Interrupted cutting


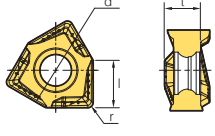

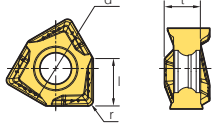

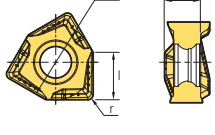

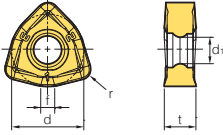

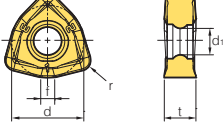

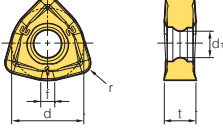
Inserts	Designation	Cermet		Coated							HVT	Dimensions (mm)								Geometries	Available tools			
		CN2500	CN30	NCM325	NCM335	NCM535	NCM545	PC2505	PC2510	PC3700		PC6510	PC9530	PC9540	PC5300	PC5400	l	d	t			r	d ₁	a
TPKN-MU 	2204PDSR-MU									●					22.0	12.7	4.76	0.8	-	1.96	-	-		E56
TPKN-SU 	1603PDSL-SU									●					16.5	9.525	3.18	1.0	-	1.70	-	-		E56
	1603PDSR-SU									●					16.5	9.525	3.18	1.0	-	1.70	-	-		E56
	2204PDSL-SU									●					22.0	12.7	4.76	1.0	-	1.91	-	-		E56
	2204PDSR-SU									●			●	●	22.0	12.7	4.76	1.0	-	1.91	-	-		E56
TPKR-MX 	1603PDSN-MX														16.5	9.525	3.18	-	-	1.2	1.2	-		E56
	1603PDSR-MX												●		16.5	9.525	3.18	-	-	1.2	0.7	-		E56
	1603PPR-MX				●										16.5	9.525	3.18	-	-	1.2	1.0	-		E56
	1603PPSN-MX														16.5	9.525	3.18	-	-	1.2	1.2	-		E56
	1603PPSR-MX					●									16.5	9.525	3.18	-	-	1.2	1.0	-		E56
	2204PDR-MX					●									22.0	12.7	4.76	1.0	-	1.4	-	-		E56
	2204PDSR-MX					●	●								22.0	12.7	4.76	1.0	-	1.4	-	-		E56
	2204PPR-MX					●	●								22.0	12.7	4.76	1.0	-	1.4	-	-		E56
TWX-KC 	16R-KC												●	16.5	9.52	3.97	0.8	4.45	-	-	-	-	E371	
	22R-KC												●	22.0	12.7	4.76	0.8	4.45	-	-	-	-	E371	
VCKT-MA 	220530N-MA											●	15.6	12.7	5.56	3.0	5.6	-	-	-	-	-	E385 E386	
VDKT-MA 	11T210N-MA											●	8.8	6.35	2.87	1.0	2.8	-	-	-	-	-	E386	
	11T220N-MA													6.7	6.35	2.87	2.0	2.8	-	-	-	-	-	E387
WDKT-MH 	080316ZDSR-MH												●	-	8.0	3.18	1.6	3.3	-	-	-	1.8	E300~ E306	
	10T320ZDSR-MH												●	-	10.0	3.97	2.0	4.3	-	-	-	2.3	E300~ E306	
	130520ZDSR-MH												●	-	13.5	5.56	2.0	5.56	-	-	-	3.1	E300~ E306	
	150625ZDSR-MH												●	-	15.0	6.35	2.5	5.56	-	-	-	3.4	E300~ E306	

● : Stock item

E Milling Inserts

Workpiece	Steel	P											Machining types				
	Stainless steel	M		●	●	●	●	●	●	●	●	●	●	●	●	●	●
Cast iron	K		●	●	●	●	●	●	●	●	●	●	●	●	●	●	●
Non-ferrous metal	N																●
Heat resistant alloy, Titanium alloy	S																●
Hardened steel	H			●	●	●											●

● Continuous cutting
 ● General cutting
 ● Interrupted cutting

Inserts	Designation	Cermets		Coated							Uncoated		Dimensions (mm)						Geometries	Available tools				
		CN2500	CN30	NCM535	NCM545	PC2010	PC2505	PC2510	PC3700	PC6510	PC9530	PC9540	PC5300	PC5400	ST30A	H01	l	d			t	r	d ₁	f
WNGX-MA 	040304PNFR-MA													●	4.3	7.0	3.46	0.4	-	-				E120~ E125
	040308PNFR-MA													●	4.3	7.0	3.46	0.8	-	-				
	040312PNFR-MA													●	4.3	7.0	3.46	1.2	-	-				
	040316PNFR-MA													●	4.3	7.0	3.46	1.6	-	-				
	080604PNFR-MA													●	8.2	13.0	6.4	0.4	-	-				
	080608PNFR-MA													●	8.2	13.0	6.4	0.8	-	-				
	080612PNFR-MA													●	8.2	13.0	6.4	1.2	-	-				
	080616PNFR-MA													●	8.2	13.0	6.4	1.6	-	-				
	080620PNFR-MA													●	8.2	13.0	6.4	2.0	-	-				
WNGX-ML 	040304PNER-ML									●		●	●	●	4.3	7.0	3.46	0.4	-	-				E120~ E125
	040308PNER-ML											●	●	●	4.3	7.0	3.46	0.8	-	-				
	040312PNER-ML												●	●	4.3	7.0	3.46	1.2	-	-				
	040316PNER-ML												●	●	4.3	7.0	3.46	1.6	-	-				
	080604PNER-ML								●		●	●	●	●	8.2	13.0	6.4	0.4	-	-				
	080608PNER-ML			●					●	●	●	●	●	●	8.2	13.0	6.4	0.8	-	-				
	080612PNER-ML								●	●	●	●	●	●	8.2	13.0	6.4	1.2	-	-				
	080616PNER-ML										●	●	●	●	8.2	13.0	6.4	1.6	-	-				
	080620PNER-ML											●	●	●	8.2	13.0	6.4	2.0	-	-				
WNGX-MM 	040304PNSR-MM									●		●	●	●	4.3	7.0	3.46	0.4	-	-				E120~ E125
	040308PNSR-MM											●	●	●	4.3	7.0	3.46	0.8	-	-				
	040312PNSR-MM												●	●	4.3	7.0	3.46	1.2	-	-				
	040316PNSR-MM												●	●	4.3	7.0	3.46	1.6	-	-				
	080604PNSR-MM								●		●	●	●	●	8.2	13.0	6.4	0.4	-	-				
	080608PNSR-MM			●					●	●	●	●	●	●	8.2	13.0	6.4	0.8	-	-				
	080612PNSR-MM								●	●	●	●	●	●	8.2	13.0	6.4	1.2	-	-				
	080616PNSR-MM										●	●	●	●	8.2	13.0	6.4	1.6	-	-				
	080620PNSR-MM											●	●	●	8.2	13.0	6.4	2.0	-	-				
WNMX-MF 	060312ZNN-MF											●	●	●	-	6.35	3.18	1.2	2.86	1.2				E289~ E299
	09T316ZNN-MF								●			●	●	●	-	9.525	3.97	1.6	3.6	1.7				
	130520ZNN-MF											●	●	●	-	12.7	5.56	2.0	4.7	2.5				
	160720ZNN-MF											●	●	●	-	16.0	7.0	2.0	5.8	3.0				
WNMX-ML 	060312ZNN-ML											●	●	●	-	6.35	3.18	1.2	2.86	1.2				E289~ E299
	09T316ZNN-ML											●	●	●	-	9.525	3.97	1.6	3.6	1.7				
	130520ZNN-ML											●	●	●	-	12.7	5.56	2.0	4.7	2.5				
	160720ZNN-ML											●	●	●	-	16.0	7.0	2.0	5.8	3.0				
WNMX-MM 	060312ZNN-MM					●	●	●				●	●	●	-	6.35	3.18	1.2	2.86	1.2				E289~ E299
	09T316ZNN-MM					●	●	●	●			●	●	●	-	9.525	3.97	1.6	3.6	1.7				
	130520ZNN-MM					●	●	●	●	●		●	●	●	-	12.7	5.56	2.0	4.7	2.5				
	160720ZNN-MM					●	●	●	●	●		●	●	●	-	16.0	7.0	2.0	5.8	3.0				


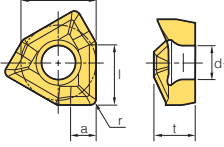

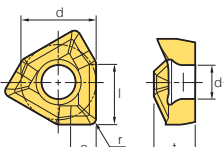

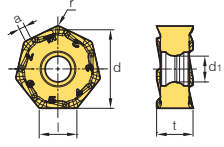

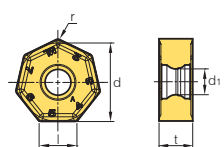

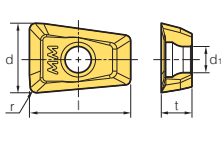
● : Stock item



E Milling Inserts

Workpiece	Steel	P	●	●	●	●	●	●	●	●	●	●	●	●	●	●	Machining types			
	Stainless steel	M															●	●	●	
	Cast iron	K															●	●	●	
	Non-ferrous metal	N															●	●	●	
	Heat resistant alloy, Titanium alloy	S															●	●	●	
	Hardened steel	H															●	●	●	


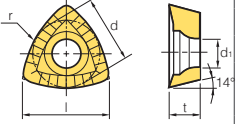

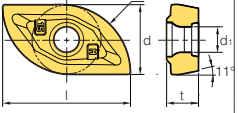

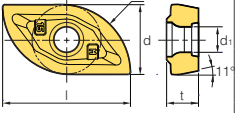

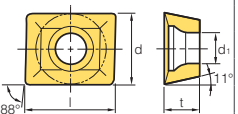

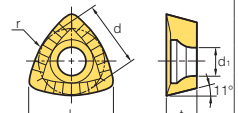

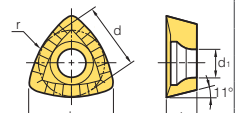
● Continuous cutting
 ● General cutting
 ● Interrupted cutting

Inserts	Designation	Cermet		Coated								Uncoated		Dimensions (mm)						Geometries	Available tools	
		CN2500	CN30	NC5330	NCM535	NCM545	PC2510	PC3700	PC6510	PC9530	PC9540	PC5300	PC5400	ST30A	H01	l	d	t	r			d ₁
XNKT-ML 	060405PNER-ML						●	●	●		●	●	●		5.7	6.5	4.0	0.5	3.4	1.8		E99~ E104
	060408PNER-ML								●		●	●			5.7	6.5	4.0	0.8	3.4	1.8		
	080504PNER-ML												●	●	8.2	10.0	5.5	0.4	4.5	2.9		
	080508PNER-ML			●			●	●	●		●	●	●		8.2	10.0	5.5	0.8	4.5	2.9		
	080512PNER-ML						●	●	●			●	●		8.2	10.0	5.5	1.2	4.5	2.9		
	080516PNER-ML											●	●		8.2	10.0	5.5	1.6	4.5	2.9		
	080520PNER-ML											●	●		8.2	10.0	5.5	2.0	4.5	2.9		
	120608PNER-ML								●	●		●	●	●	12.0	13.0	6.5	0.8	5.5	3.5		
	120612PNER-ML											●	●	●	12.0	13.0	6.5	1.2	5.5	3.5		
	120616PNER-ML											●	●	●	12.0	13.0	6.5	1.6	5.5	3.5		
	120620PNER-ML											●	●	●	12.0	13.0	6.5	2.0	5.5	3.5		
XNKT-MM 	060405PNSR-MM						●	●	●		●	●	●		5.7	6.5	4.0	0.5	3.4	1.8		E99~ E104
	060408PNSR-MM						●	●	●		●	●	●		5.7	6.5	4.0	0.8	3.4	1.8		
	080504PNSR-MM												●	●	8.2	10.0	5.5	0.4	4.5	2.9		
	080508PNSR-MM			●			●	●	●		●	●	●		8.2	10.0	5.5	0.8	4.5	2.9		
	080512PNSR-MM						●	●	●			●	●		8.2	10.0	5.5	1.2	4.5	2.9		
	080516PNSR-MM						●	●	●			●	●		8.2	10.0	5.5	1.6	4.5	2.9		
	080520PNSR-MM						●	●	●			●	●		8.2	10.0	5.5	2.0	4.5	2.9		
	120604PNSR-MM											●	●	●	12.0	13.0	6.5	0.4	5.5	3.5		
	120608PNSR-MM						●	●	●	●		●	●	●	12.0	13.0	6.5	0.8	5.5	3.5		
	120612PNSR-MM						●	●	●			●	●	●	12.0	13.0	6.5	1.2	5.5	3.5		
	120616PNSR-MM						●	●	●			●	●	●	12.0	13.0	6.5	1.6	5.5	3.5		
120620PNSR-MM						●	●	●			●	●	●	12.0	13.0	6.5	2.0	5.5	3.5			
XNMX-ML 	0606XNR-ML			●					●		●	●	●		6.7	14.0	6.5	0.8	4.6	1.0		E142
XNMX-ML 	060608-ML			●					●		●	●	●		6.7	14.0	6.0	0.8	4.6	-		E142
XPMT-MM 	0802ER-MM											●		10.5	7.25	3.18	0.8	-	-		E339 E340	
	1003ER-MM											●		10.5	7.25	3.18	0.8	-	-			
	13T3ER-MM											●		13.1	9	3.97	0.8	-	-			
	1604ER-MM											●		16.5	11.5	4.76	0.8	-	-			
	1805ER-MM											●		18	12.4	5.56	0.8	-	-			
	2006ER-MM											●		20.5	14.1	6.35	0.8	-	-			
	2507ER-MM											●		25.5	17.6	7.94	0.8	-	-			












● : Stock item



Workpiece	Machining types										
	P	M	K	N	S	H	●	⊕	⊛	⊚	⊙
Steel	●	●	●	●	●	●	●	●	●	●	●
Stainless steel	●	●	●	●	●	●	●	●	●	●	●
Cast iron	●	●	●	●	●	●	●	●	●	●	●
Non-ferrous metal	●	●	●	●	●	●	●	●	●	●	●
Heat resistant alloy, Titanium alloy	●	●	●	●	●	●	●	●	●	●	●
Hardened steel	●	●	●	●	●	●	●	●	●	●	●










Inserts	Designation	Cermets		Coated							Uncoated		Dimensions (mm)					Geometries	Available tools		
		CN2500	CN30	NC5330	NCM535	NCM545	PC2505	PC2510	PC3700	PC6510	PC9530	PC9540	PC5300	PC5400	ST30A	H01	l			d	t
	080310R-MM							●				●			8.4	6.73	3.2	10	2.8		E339 E340
	110312.5R-MM							●				●			10.6	8.5	3.65	12.5	2.8		
	130416R-MM								●				●			13.2	10.5	4.76	16		
	080M-MM														16	8.0	3.5	8	2.9		E332~ E334
	090M-MM														17.7	7.2	4.3	9	3.4		
	100M-MM							●	●			●			19	10.4	4.5	10	3.4		
	110M-MM														22.2	11.4	4.8	11	4.5		
	125M-MM							●	●			●			24	12.9	5.3	12.5	4.5		
	130M-MM														25.7	13.4	5.3	13	4.5		
	140M-MM														27.2	14.3	6.3	14	5.6		
	150M-MM								●				●		28	15.4	7	15	5.6		
	160M-MM								●	●			●		28.5	16.4	7	16	5.6		
	200M-MM								●						38	20.7	8	20	6.6		
250M-MM														48	25.9	9.5	25	8.6			
	080S-MM														15	6.6	3.1	8	2.9		E332~ E334
	090S-MM														15.5	7.4	3.7	9	3.4		
	100S-MM							●	●			●			15.5	8.4	3.8	10	3.4		
	110S-MM														18.1	9	4.4	11	4.5		
	125S-MM							●	●			●			20.5	10.7	4.5	12.5	4.5		
	130S-MM														22.2	11	4.4	13	4.5		
	140S-MM														24.1	11.2	5.7	14	5.6		
	150S-MM								●				●		25	12.4	6.5	15	5.6		
	160S-MM								●	●			●		26	13.4	6.5	16	5.6		
	200S-MM								●						32	16.7	7	20	6.6		
250S-MM														40	20.7	8.5	25	8.6			
	1504PPSR-MM								●			●			15.9	12.7	4.76	-	5.6		E307 E352
	1505PPSR-MMN														15.9	12.7	5.76	-	5.6		
	160520R-MM								●			●			16.1	12.7	5.56	20	5.6		E336
	160525R-MM								●			●			16.9	12.7	5.56	25	5.6		
	160531.5R-MM												●		17.6	12.7	5.56	31.5	5.6		
	160525R-MR														17.6	12.7	5.56	25	5.6		E335 E336

● : Stock item











Type	Cutter	Designation	Shape	A.A	Diameter range	Features	Application					Page
							Facing	Shouldering	Slotting	Copying	Ramping, Helical	
Cutters for face milling	Mill-max	ADN(M) 4000/5000+		45°	Ø80~Ø315	Excellent cutting-edge strength and chip flow	●					E47 E48
		AE(M) 4000/5000		45°	Ø80~Ø315	Low cutting load and good machinability	●					E49 E50
		EF(M) 4000	Al 	75°	Ø80~Ø315	High rake angle to prevents welding	●					E51
		EN(M) 4000		75°	Ø80~Ø315	Economical because double sided inserts applied	●					E52
		EPN(M) 4000/5000+		75°	Ø80~Ø315	Double posi rake angle and low cutting force	●					E53 E54
		PF(M) 4000	Al 	90°	Ø80~Ø315	High rake angle and good machinability	●	●	●			E55
		PPN(M) 4000		90°	Ø80~Ø315	Double posi rake angle and low cutting force	●	●	●			E56
	Mill-max Heavy	HDDCM 7000/9000 new		55°	Ø125~Ø315	Deep roughing availability thanks to highly rigid inserts	●					E58
	Turbo Mill	ADS 4000/5000		45°	Ø50~Ø63	Anti-vibration	●					E59 E60
		PES 2000/3000/ 4000		90°	Ø20~Ø63	High rake angle, Cutting efficiency	●	●	●			E61
	Double Mill	AFO(M)4000		45°	Ø80~Ø125	High rake angle low cutting force	●					E62
		AFO(M)5000			Ø80~Ø315	Economical (8 corners available)						E63

Al Cutter for aluminum






















Type	Cutter	Designation	Shape	A.A	Diameter range	Features	Application					Page
							Facing	Shouldering	Slotting	Copying	Ramping, Helical	
Cutters for face milling	Power Buster	PBAC(M)5000		45°	Ø80~Ø315		●					E68
		PBZC(M)5000		90°	Ø80~Ø315	Double-sided Insert High depth High feed roughing	●					E69
		PBPCM6000 <small>new</small>			Ø80~Ø315		● ●				E70	
	Aero Mill	APD(M) A type		90°	Ø80~Ø315	Aluminum cutter body suitable for high speed machining. Both cemented carbides and PCD inserts are available, G2.5 balance possible	●					E151
	Aero Mill - Plus	APD(M)-PB		90°	Ø80~Ø315	Prevent overload to the spindle bearings through weight reduction of the Al alloy body and enable high-speed processing	●					E152 E153
	Aero Mill-Mini	MAPDS		90°	Ø40~Ø63	Available with small Machining center-Carbide, PCD insert	●					E154
		MAPD		90°	Ø32~Ø40	Application-Balancing class G2.5	●					E155
	Rich Mill	RM8AC(M)4000 RMH8AC(M)4000		45°	Ø50~Ø400	8 corners available Double-sided insert for steel, cast iron, stainless steel, aluminum	●					E126 E127
		RM8AC(M)5000 RMH8AC(M)5000			Ø80~Ø400		●				E128 E129	
		RM8EC(M)4000 RMH8EC(M)4000		75°	Ø50~Ø400	8 corners available Double-sided insert for steel, cast iron	●					E130 E131
		RM8EC(M)5000 RM8HEC(M)5000			Ø80~Ø400		●				E132 E133	

 Cutter for aluminum













Type	Cutter	Designation	Shape	A.A	Diameter range	Features	Application					Page	
							Facing	Shouldering	Slotting	Copying	Ramping, Helical		
Cutters for face milling	Rich Mill	RM8QC(M)4000 RMH8QC(M)4000		88°	Ø63~Ø200	8 corners available Reduced cutting interruption at cast Iron	●					E134 E135	
		RMT8A(M)4000/5000		45°	Ø80~Ø315		●					E136 E137	
		RMT8E(M)4000/5000		75°	Ø80~Ø315	Easy insert change and good machinability due to latch clamping system 8 corners available Excellent surface finish	●					E138 E139	
		RMT8Q(M)4000		88°	Ø80~Ø315		●					E140	
		RMX8AC(M)-SA14 <small>new</small>		45°	Ø50~Ø125	Double sided insert with 8 corners Stable cutting performance due to double reversal positive relief surface Good machinability in stainless cutting with High helix cutting edge	●					E141	
		RM14XCM-XN06 <small>new</small>		51°	Ø50~Ø160	Double sided insert with 14 corners Suitable for automobile components machining	●					E142	
		RM16AC(M)6000/8000		45°	Ø63~Ø400	16 corners available Wiper inserts can be applied for good surface finish Strong insert and powerful clamping	●					E143 E144	
		RMRC(M)-RN12 <small>new</small>		-	Ø50~Ø125	High cost efficiency due to double sided round typed cutting edge Excellent rotating prevention by strong clamping system Suitable for Inconel cutting	●					E145	
		Cutters for molds	Rich Mill	RM3PC(M)3000 <small>new</small>			Ø40~Ø80						E99
				RM3PC(M)4000 <small>new</small>		90°	Ø40~Ø125	Perfect perpendicularity Strong clamping	●	●	●	●	E100
				RM3PC(M)5000 <small>new</small>			Ø80~Ø125						E101
				RM4PC(M)3000		90°	Ø40~Ø100	4 corners available High rake angle insert reduces cutting force. Excellent insert rigidity	●	●	●	●	E105 E106
				RM4PC(M)4000			Ø50~Ø160						

















Type	Cutter	Designation	Shape	A.A	Diameter range	Features	Application					Page
							Facing	Shouldering	Slotting	Copying	Ramping, Helical	
Cutters for molds	Rich Mill	RM4ZCM3000		90°	Ø40~Ø52	4 corners available In vertical machining, the maximum cutting depth for RM4Z3000: 9.00 mm, RM4Z4000: 14.0 mm	●	●	●	●	●	E118
		RM4ZC(M)4000			Ø63~Ø100							
		RM6PCM-WN04 <small>new</small>		90°	Ø40~Ø63	Improved productivity and high-quality shouldering through high speed and high feed machining	●	●	●	●	●	E120
		RM6PC(M)-WN08 <small>new</small>			Ø50~Ø125							
	Alpha Mill-X	AMXCM-AD10/12/17 <small>new</small>		90°	Ø40~Ø125	High rake angle cutting edge and chip breaker reduce cutting load and improve chip evacuation. High rigidity due to special design	●	●	●	●	●	E197 E198
	Alpha Mill	AMC(M) 1000S/1500S/2000S		90°	Ø32~Ø100	3-dimensional shape and high rake angle lowers cutting load and ensures better chip evacuation Inner coolant system for better chip control increases tool life Wide size range of inserts enlarges application range. Various types of Alpha Mills available for high depth of cut and high feed machining	●	●	●	●	●	E164~ E166
		AMC(M) 3000S/3000S-K /4000S		90°	Ø40~Ø200		●	●	●	●	●	E167~ E169
		AMC(M) 1000SE 2000SE 3000SE		75°	Ø40~Ø100		●	●	●	●	●	E170 E171
		AMC(M) 2000M 3000M 4000M		90°	Ø50~Ø125		●	●	●	●	●	E172~ E174
	Future Mill	FMAC(M)3000		45°	Ø50~Ø125	Accurate inserts and cutter, Excellent chip flow	●					E226
		FMAC(M)4000			Ø50~Ø200							
		FMAC(M)3000-A		45°	Ø63~Ø125	Excellent in high speed cutting and tapping center, low power machine due to light aluminum body	●					E228
FMAC(M)4000-A		Ø63~Ø315			E229							

Type	Cutter	Designation	Shape	A.A	Diameter range	Features	Application					Page
							Facing	Shouldering	Slotting	Copying	Ramping, Helical	
Cutters for molds	Future Mill	FMPC(M)3000		90°	Ø50~Ø100	4 corners available various inserts can be applied to machine for different types of workpiece	●	●	●			E222
		Ø63~Ø125						E223				
		FMPC(M)3000A		90°	Ø63~Ø100	Excellent in high speed cutting and tapping center, low power machine due to light aluminum body	●	●	●			E224
		Ø63~Ø315						E225				
		FMRC(M)3000		-	Ø40~Ø100	4~8 corners available	●	●	●	●	●	E228
		Ø50~Ø125			Double contact faces between insert & seat part of cutter for stable clamping				E229			
		FMRC(M)5000		-	Ø50~Ø125	Excellent rotating-free machining	●	●	●	●	●	E230
		Ø63~Ø160						E231				
	Future Mill P-positive	FMRC(M) ^{new} 3000 4000 5000 6000		-	Ø40~Ø250	Stable clamping system enables stable machining and productivity Varied product line-up ensures wide application range Optimal shape and grade with high hardness for hard-to-cut material machining.	●	●	●	●	●	E242~ E245
	Triple Mill	TPMCM-TN16		90°	Ø50~Ø125	3-cornered insert for shouldering	●	●	●			E258
		TPMCM-TN20			Ø63~Ø125	-Reduced cutting resistance due to high rake angled cutting edge and chip breaker					E259	
	HFMD	HFMDCM-LN06		-	Ø32~Ø66	Double sided with 4 corners insert for small diameter machining	●	●	●			E272
		HFMD(M)-LN10			Ø40~Ø100	For high feed and multi-functional machining Strong clamping realizes stable machining.			●		E273	
	HRM	HRMC(M)13		15°	Ø50~Ø80	Powerful clamping by double clamping system	●	●	●		●	E300
		HRMC(M)15			Ø63~Ø160	3 corners available high feed cutting with low cutting load					E301	
	HRMD	HRMDC(M)09		14°	Ø40~Ø100	Double side insert with 6 corner High feed cutting with strong simple screw-on clamp	●	●	●		●	E289
		HRMDC(M)13			Ø50~Ø125				E290			
		HRMDC(M)16 ^{new}			Ø80~Ø315				E291			
	Tangen-Pro	TP2PC(M)-LN08 ^{new}		90°	Ø40~Ø63	High-quality results available even under harsh cutting conditions, thanks to the stable clamping force	●	●	●			E311
		TP2PC(M)-LN14 ^{new}			Ø40~Ø125				E312			
TP2PC(M)-LN17 ^{new}		Ø40~Ø125						E313				


























Type	Cutter	Designation	Shape	A.A	Diameter range	Features	Application					Page	
							Facing	Shouldering	Slotting	Copying	Ramping, Helical		
Cutters for molds	BT/HSK Tooling System	BT30/40/50		90°	Ø10~Ø50	BT/HSK one solid type has been accepted to increase the precision Inner coolant system can also make it possible to evacuate the chip effectively	●	●	●	●		E342~E346	
		HSK63									E353~E357		
		BT30/40/50		90°	Ø16~Ø100	High feed and high depth	●	●	●	●		E347~E351	
		HSK63/100									E358~E362		
		BT30/40/50-MAT		90°	Ø12~Ø40	Alpha Mill, Rich Mill, FMR, Laser Mill, HRM(D), Pro-A, Pro-X Modular head M06~M16 applicable	●	●	●	●	●		E403
		HSK63/100-MAT											
	BT50 HAT4000		90°	Ø50~Ø80	Head only replacement possible and higher efficiency by self assembly head	●	●	●	●	●		E352	
Cutters for aluminum	Pro-A Mill	PAC(M) 2000/4000		90°	Ø40~Ø100	Buffed insert controls chip flow without built-up edge	●	●	●	●	●	E385	
	Pro-X Mill	PAXC(M)5000		90°	Ø40~Ø125	Powerful clamping Excellent body rigidity for rectangular and curve machining	●	●	●	●	●	E388	
		PAXC(M)6000			Ø50~Ø125							E389	
	Pro-L Mill	PALC(M)		90°	Ø63	High helix and high depth of cut High perpendicularity Low cutting load	●	●	●	●	●	E394	
	Pro-V Mill	PAVCM-XD19		90°	Ø40~Ø125	Exclusive milling tool for high speed aluminum machining with key to key way structure ensures stable clamping.	●	●	●	●	●	E399	
Indexable side cutter	Tangential type	Full-side cutter	TAFCP		-	Ø100~Ø315	Various cutting depth can be possible because of adjustable length control. Medium to Roughing based on strengthened edge	●	●	●	●	E407	
		TAFCB		-	Ø100~Ø315	●		●	●	●	E407		
	Half-side cutter	TAHCP		-	Ø100~Ø315	●		●	●	●	E408		
		TAHCB		-	Ø100~Ø315	●		●	●	●	E408		

 Cutter for aluminum












Type	Cutter	Designation	Shape	A.A	Diameter range	Features	Application					Page	
							Facing	Shouldering	Slotting	Copying	Ramping, Helical		
Indexable side cutter	Radial type	Full-side cutter	RAFCP		-	Ø100~Ø315	Wide range of machining width with only one side cutter due to adjustable cutting-edge height Suitable for medium and finishing in narrow width side cutting due to good chip evacuation by 3-dimensional chip breaker		●	●			E409
		RAFCB		-	Ø100~Ø315	●		●	●			E409	
	Half-side cutter	RAHCP		-	Ø100~Ø315			●	●			E410	
	RAHCB		-	Ø100~Ø315	●	●		●			E410		
Side cutters	Full-side cutter	SPP(M)		-	Ø80~Ø200	Economical by using pentagonal insert Suitable for narrow & deep grooving			●			E411	
		SPB(M)		-	Ø80~Ø200	Economical by using pentagonal insert Suitable for narrow & deep grooving			●			E412	
		SPS		-	Ø50~Ø200	For narrow and deep width grooving			●			E413	
	Full-side cutter	RM4PFCB		-	Ø80~Ø160	4 corner usage with double-sided insert can be economical			●			E107 E108	
		RM4PFCP		-	Ø80~Ø160				●			E111 E112	
	Half-side cutter	RM4PHCB		-	Ø80~Ø160	4 corner usage with double-sided insert can be economical			●			E109 E110	
		RM4PHCP		-	Ø80~Ø160				●			E113 E114	
	Wind Mill	WFSB(M)		-	Ø100~Ø250	The nose R shape of insert ensures long tool life. Wide applications with various widths and corner R sizes.	●	●	●			E416	
		WFSP(M)		-	Ø100~Ø250			●	●			E417	














Type	Cutter	Designation	Shape	A.A	Diameter range	Features	Application					Page	
							Facing	Shouldering	Slotting	Copying	Ramping, Helical		
Cutters for face milling	Turbo Mill	ADS 4000/5000		45°	Ø50~Ø63	Uneven insert spacing prevents chattering	●					E59 E60	
		PES 2000/3000/4000		90°	Ø20~Ø63	Good machinability due to the high rake angle	●	●	●			E61	
Cutters for molds	Rich Mill	RM3PS3000		90°	Ø20~Ø40	Perfect perpendicularity Strong clamping	●	●	●	●		E102	
		RM3PS4000 <small>new</small>			Ø32~Ø63							E103	
		RM4PS3000		90°	Ø14~Ø50	4 corners available High rake angle insert reduces cutting force	●	●	●		●	E115	
		RM4PS4000 <small>new</small>			Ø32~Ø63	Excellent insert rigidity	●	●	●		●	E116	
		RM4ZS3000		90°	Ø25~Ø40	In vertical machining, the maximum cutting width: 9.0 mm	●	●	●		●	E119	
		RM6PS-WN04 <small>new</small>		90°	Ø20~Ø32	Improved productivity and high-quality shouldering through high speed and high feed machining	●	●	●		●	E122	
		RM6PS-WN08 <small>new</small>			Ø32~Ø50							E123	
		RMRS-RN12 <small>new</small>		-	Ø32~Ø63	High cost efficiency due to double sided round typed cutting edge Excellent rotating prevention by strong clamping system Suitable for Inconel cutting	●					E146	
		AMXS-AD10/12/17 <small>new</small>		90°	Ø20~Ø40	High rake angle cutting edge and chip breaker reduce cutting resistance and improve chip evacuation. High rigidity due to special design	●	●	●	●	●	E199 E200	
		Alpha Mill	AMS 1000S/1500S 2000S/3000S 3000S-K/4000S		90°	Ø10~Ø63	The combination of a 3-dimensional curve design & high rake angle helps chip-evacuation effectively with a low cutting force Inner coolant system The various range of inserts can provide the widened choice High depth and high feed can be available during operation	●	●	●	●	●	E175~ E182
			AMS 1000SE/2000SE 3000SE		75°	Ø25~Ø63							E183 E184
			AMS 1000M/1500M 2000M/4000M		90°	Ø16~Ø50							E185~ E187
AMS 1000MH/1500MH 2000MH/3000MH(-K)			90°	Ø14~Ø40	E188 E189								

Type	Cutter	Designation	Shape	A.A	Diameter range	Features	Application					Page	
							Facing	Shouldering	Slotting	Copying	Ramping, Helical		
Cutters for molds	Future Mill	FMAS3000		45°	Ø25~Ø63	For precision machining Excellent chip evacuation	●					E220	
		FMAS4000			Ø50~Ø63							E221	
		FMPS3000		90°	Ø25~Ø63	4 corners available Strong cutting-edge with low cutting load	●						E226
		FMPS4000			Ø40~Ø63								E227
		FMRS 1000/1500/2000 2500/3000/4000 5000/6000		-	Ø8~Ø63	2 touch clamping system, convenient insert change	●	●	●	●	●		E232~E237
	Future Mill P-positive	FMRS ^{new} 2500/3000 4000/5000 6000		-	Ø17~Ø50	P-positive relief angle ensures high rigidity and high machinability in die steel and high-resistant alloy machining Flat clearance face of insert prevents interference and revolution while machining	●	●	●	●	●		E246~E249
	Triple Mill	TPMS-TN11 ^{new}		90°	Ø25~Ø40	3-cornered insert for shouldering Reduced cutting resistance due to high rake angled cutting edge and chip breaker	●	●	●				E260
		TPMS-TN16 ^{new}			Ø32~Ø40								E261
	HFMD	HFMS-LN04 ^{new}		-	Ø8~Ø21	Double sided insert with 4 corners for small diameter machining For high feed and multi-functional machining Strong clamping system for stable machining	●	●	●	●	●		E267
		HFMS-LN06 ^{new}			Ø16~Ø40								E268
		HFMS-LN10			Ø25~Ø42								E269 E270 E271
	HFM	HFMS ^{new} 1000		13°	Ø8~Ø21	Apply helix cutting-edge on insert, low cutting load and reinforce toughness on corner Increased rigidity with double relief angle (11, 13), prevent interference with high feed To apply the negative axial rake angle when set up the holder, increased chipping resistance	●	●	●	●	●		E281 E282
	HRM	HRMS 08/10/13/15		15°	Ø20~Ø63	Powerful clamping by double clamping system 3 corners available High feed cutting with low cutting load	●	●	●	●	●		E302~E304
	HRMD	HRMS 06/09/13		14°	Ø16~Ø63	6 corners available, High feed, multi-function, only one screw application	●	●	●	●	●		E292~E296
	Tangen-Pro	TP2PS-LN08 ^{new}		90°	Ø16~Ø25	High-quality results available even under harsh cutting conditions, thanks to the stable clamping force	●	●	●				E311
		TP2PS-LN14 ^{new}			Ø25~Ø50								E312
TP2PS-LN17 ^{new}		Ø32~Ø50			E313								
Tank Mill	THE		90°	Ø25~Ø50	Right-hand helix angle employed for good chip evacuation. Special surface treatment prevents body breaking and improves rigidity. Strong cutting-edge	●	●					E307	




Type	Cutter	Designation	Shape	A.A	Diameter range	Features	Application					Page
							Facing	Shouldering	Slotting	Copying	Ramping, Helical	
Cutters for molds	Laser Mill	LBE□□ LRE□□		-	Ø8~Ø32	Indexable ball endmill for precise mold. Rigid holder with simple design finishing MQL is available	●	●	●	●		E326~ E330
		LBE□□-C LRE□□-C		-	Ø8~Ø32	Indexable ball endmill for precise mold. Rigid holder with simple design finishing MQL is available Carbide shank	●	●	●			E326~ E330
	Mach Mill	BFE		-	Ø16~Ø32	Upgraded cutting performance with S type curve design V clamping application	●	●	●	●		E331
		GBE		-	Ø16~Ø50	Helical design of edge can reduce the force during operation. Safe application to prevent rotation guarantee the increased tool life	●	●	●	●		E332 E333
		BRE		-	Ø20~Ø63	Flute type chip-pocket can make chip-evacuation Customized edge design can prevent the breakage of holder's body	●	●	●	●		E335
	HAVE	Multi-edge		90°	Ø16~Ø50	Tools for Z-axis feed plunge machining to cut faster and more effectively in vertical machining	●	●	●		●	E339
		Single-edge				Machining with whole diameter						E340
	O-ring Cutter	ORC		90°	Ø11~Ø46	For grooving the seat of an O-Ring in a plastic mold Superior surface roughness and cutting performance compared to HSS and brazed tool	-	-	-	-	-	E365
	Chamfer Tool	CE		75°	Ø25~Ø30	For Back & Front high quality chamfering and various Chamfering angle machining	●					E369
				60°	Ø25~Ø35							
				45°	Ø7~Ø39							
				30°	Ø25~Ø42							
CE			30°	Ø5~Ø35	Various chamfer degrees available Effective long chamfer cutting available	●	●	●			E370	
			45°	Ø5~Ø48								
			60°	Ø5~Ø57								
CE		45°	~Ø28	Centering, Grooving, Chamfering	●	●	●		●	E371		

Type	Cutter	Designation	Shape	A.A	Diameter range	Features	Application					Page
							Facing	Shouldering	Slotting	Copying	Ramping, Helical	
Cutters for molds	Chamfer Tool	CCT		30°	Ø3~Ø16	Centering, Countersinking, Chamfering						E373
				45°								
				60°								
	Chamfer Tool	CET		30°	Ø4~Ø16	Countersinking, Chamfering, Shouldering	●	●	●		●	E372
				45°								
				60°								
T-Cutter	TFE		90°	Ø21~Ø50	For slotting	●	●	●	●	●	E374	
Cutters for aluminum	Pro-A Mill	PAS 2000/4000		90°	Ø12~Ø42 Ø32~Ø40	Polished face increases chip flow and reduces built-up edge	●	●	●	●	●	E386
	Pro-X Mill	PAXS 5000/6000		90°	Ø20~Ø40 Ø25~Ø40	Square shoulder and corner machining	●	●	●	●	●	E390 E391
	Pro-L Mill	PALS-HR (Single-edge)		90°	Ø32~Ø63	High helix and high depth of cut High perpendicularity Low cutting load	●	●	●	●	●	E395 E396
		PALS-HM (Multi-edge)			Ø63		●	●	●	●	●	E397
	Pro-XL Mill	PXLS ^{new}		90°	Ø40~Ø80	Improved surface finish and perpendicularity achieved by a single pass with the deep cutting-edges	●	●				E398
	Pro-V Mill	PAVS-XD19 ^{new}		90°	Ø25~Ø40	Exclusive milling tool for high speed aluminum machining with key to key way structure ensures stable machining.	●	●	●	●	●	E400
		HSK-XD19 ^{new}			Ø32~Ø50		●	●	●	●	●	E363
	Thread milling	-	TM		-	Ø32~Ø50	For internal and external threading	●				



<p>FMRM type</p> <p>➔ E238~241 E250~253</p>			<p>Steel Shank type</p> <p>➔ E401</p>
<p>LBE-MHD type</p> <p>➔ E330</p>			<p>Carbide Shank type</p> <p>➔ E402</p>
<p>PAM type</p> <p>➔ E387</p>			<p>BT Arbors type</p> <p>➔ E403</p>
<p>PAXM type</p> <p>➔ E392</p>			<p>HSK Arbors type</p> <p>➔ E404</p>
<p>AMM type</p> <p>➔ E190~192</p>			
<p>RM3PM type</p> <p>➔ E104</p>			
<p>RM4PM type</p> <p>➔ E117</p>			

E KORLOY Modular Adaptors

RM4ZM type

 → E119

RM6PM type

 → E124, 125

HFMDM type


 → E274~276


HFMM type

 → E283

HRMM type

 → E305, 306

HRMDM type

 → E297~299

GBEM type

 → E334



Steel Shank type
 → E401



Carbide Shank type
 → E402



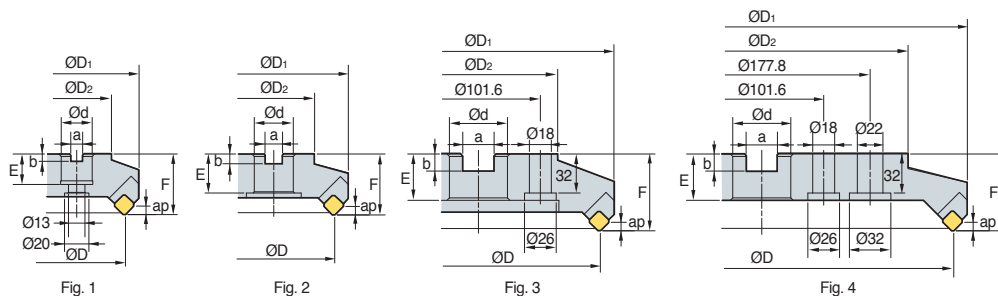
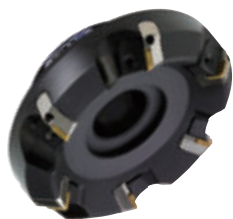
BT Arbors type
 → E403



HSK Arbors type
 → E404



ADN(M)4000



AA
45°
• AR: 15°
• RR: -4°

Designation	ØD	ØD1	ØD2	Ød	a	b	E	F	ap	kg	Fig.
ADN 4080R/L	80	57	57	25.4 (27)	9.5 (12.4)	6 (7)	25 (22)	50	6	1.9	1
(ADNM) 4100R/L	100	67	67	31.75 (32)	12.7 (14.4)	8 (8)	32 (28)	50	6	2.5	2
4125R/L	125	87	87	38.1 (40)	15.9 (16.4)	10 (9)	38 (30)	63	6	4.3	2
4160R/L	160	107	107	50.8 (40)	19.0 (16.4)	11 (9)	38 (30)	63	6	6.4	2
4200R/L	200	130	130	47.625 (60)	25.4 (25.7)	14 (14)	38 (38)	63	6	8.7	3
4250R/L	250	180	180	47.625 (60)	25.4 (25.7)	14 (14)	38 (38)	63	6	14.0	3
4315R/L	315	240	240	47.625 (60)	25.4 (25.7)	14 (14)	38 (38)	63	6	21.0	4

(mm)

() Metric size

Available inserts

	SDCN	SDKN-MU	SDKN-SU	SDKR-MX	
Designation	Cermet	Coated		Uncoated	page
	CN2500 CN30	NCM325 NCM335 NCM335 NCM545	PC3700 PC6510 PC9530 PC9540 PC5300 PC5400	ST30A G10 H01	
SDCN 42M				●	
42M-G				●	
42MT	●●	●		●	
42MT-RH					E19
42MT-S20			●		
1203AEEN					
1203AEEN-RH					
1203AESN					
1203AESN-RH					
SDKN 1203AESN-MU			●		E20
1203AESN-SU			●	●●	
SDKR 1203AESN-MX					E20
1203AETN-MX					
1203AEN-MX		●			

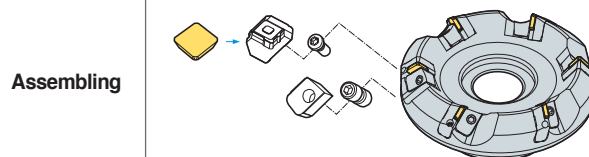
Available arbors

Designation	General arbor	NC arbors	
		ADN	ADNM
ADN 4080R/L	NT*□□ (MU)-FMA25.4-25	BT**□□-FMA25.4-□□	FMC27
(ADNM) 4100R/L	NT*□□ (MU)-FMA31.75-□□	BT**□□-FMA31.75-□□	FMC32
4125R/L	NT*□□ (MU)-FMA38.1-□□	BT**□□-FMA38.1-□□	FMB40
4160R/L	NT*□□ (MU)-FMA50.8-□□	BT**□□-FMA50.8-□□	FMB40
4200R/L	NT*□□ (MU)-FMA47.625-25, KCP-8***	BT**□□-FMA47.625-□□	FMB60
4250R/L	NT*□□ (MU)-FMA47.625-25, KCP-8***	BT**□□-FMA47.625-□□	FMB60
4315R/L	KCP-8*** (Center ring plug)		

*□□-NT number **□□-BT number ***Over milling 5

Recommended cutting condition

Workpiece	Cutting condition		Grades
	vc (m/min)	fz (mm/t)	
P	190~320	0.05~0.20	NCM325 PC3700 ST30A
	161~270	0.05~0.20	
	80~140	0.05~0.20	
M	90~150	0.05~0.20	PC9530
K	140~230	0.05~0.30	PC6510 G10
	50~90	0.05~0.30	



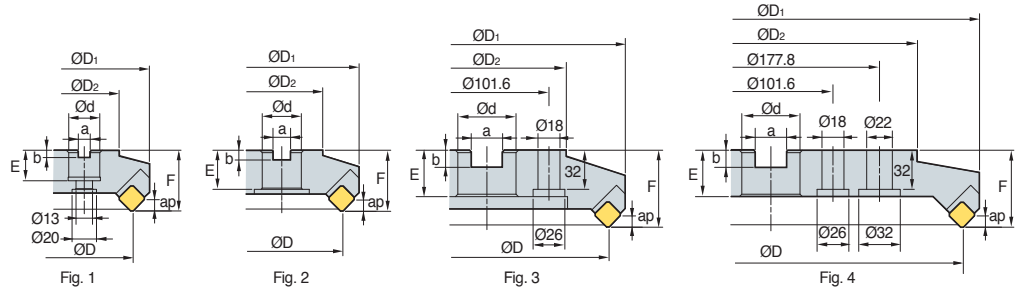
Parts

Specification					
Ø80-Ø315	LADN4R/L	WEPN4R/L	DHA0821F	LTX0514	HW40

Available inserts E19, E20

Available arbors and bolt E426~E428

ADN(M)5000+



AA
45°
• AR: 15°
• RR: -4°

(mm)

Designation	ØD	ØD1	ØD2	Ød	a	b	E	F	ap	kg	Fig.
ADN 5080R/L+	80	107	65	25.4(27)	9.5 (12.4)	6 (7)	25 (22)	63	8	2.4	1
(ADNM) 5100R/L+	100	126	75	31.75(32)	12.7 (14.4)	8 (8)	32 (28)	63	8	3.0	2
5125R/L+	125	150	100	38.1(40)	15.9 (16.4)	10 (9)	38 (30)	63	8	4.7	2
5160R/L+	160	185	120	50.8(40)	19.0 (16.4)	11 (9)	38 (30)	63	8	6.5	2
5200R/L+	200	225	140	47.625(60)	25.4 (25.7)	14 (14)	38 (38)	63	8	8.7	3
5250R/L+	250	275	220	47.625(60)	25.4 (25.7)	14 (14)	38 (38)	63	8	15.5	3
5315R/L+	315	340	280	47.625(60)	25.4 (25.7)	14 (14)	38 (38)	63	8	23.7	4

() Metric size

Available inserts

		SDCN	SDKN-MU	SDKN-SU	SDKR-MX													
Designation	page	Cermet		Coated		Uncoated												
		CN2500	CN30	NC5330	NCM325	NCM335	NCM535	NCM545	PC3700	PC6510	PC9530	PC9540	PC5300	PC5400	ST30A	G10	H01	
SDCN 53M																		
53M-G																		
53MT			●	●														
53MT-RH																		
53MT-S20																		E19
1504AEEN																		
1504AEEN-RH																		
1504AESN																		
1504AESN-RH																		
SDKN 1504AESN-MU																		E20
1504AESN-SU																		
SDKR 1504AESN-MX																		
1504AETN-MX																		E20
1504AEN-MX																		

Available arbors

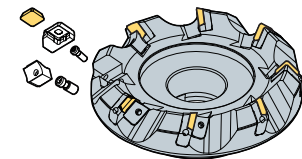
Designation	General arbor	NC arbors	
		ADN	ADNM
ADN 5080R/L+	NT*□□ (MU)-FMA25.4-25	BT**□□ -FMA25.4-□□	FMC27
(ADNM) 5100R/L+	NT*□□ (MU)-FMA31.75-□□	BT**□□ -FMA31.75-□□	FMC32
5125R/L+	NT*□□ (MU)-FMA38.1-□□	BT**□□ -FMA38.1-□□	FMB40
5160R/L+	NT*□□ (MU)-FMA50.8-□□	BT**□□ -FMA50.8-□□	FMB40
5200R/L+	NT*□□ (MU)-FMA47.625-25, KCP-8**	BT**□□ -FMA47.625-□□	FMB60
5250R/L+	NT*□□ (MU)-FMA47.625-25, KCP-8**	BT**□□ -FMA47.625-□□	FMB60
5315R/L+	KCP-8*** (Center ring plug)		

*□□-NT number **□□-BT number ***Over milling 5

Recommended cutting condition

Workpiece	Cutting condition		Grades
	vc (m/min)	fz (mm/t)	
P	190~320	0.05~0.20	NCM325 PC3700 ST30A
	161~270	0.05~0.20	
	80~140	0.05~0.20	
M	90~150	0.05~0.20	PC9530
K	140~230	0.05~0.30	PC6510 G10
	50~90	0.05~0.30	

Assembling



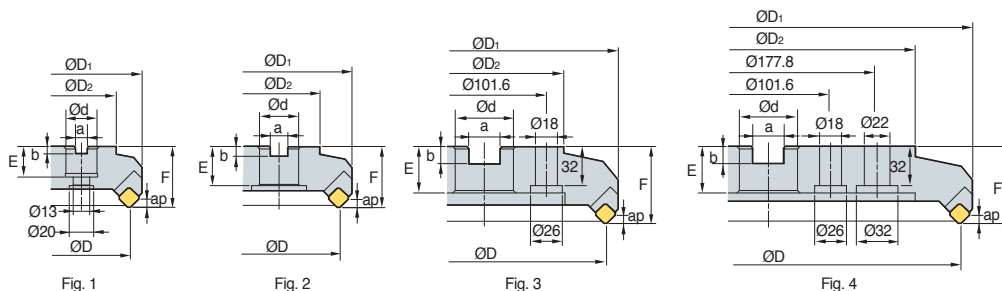
Parts

Specification					
Ø80~Ø315	LADN5R/L	WHPS5R/L	WHX0817 WHX0813*	LTX0514	HW40

*: Ø80

Available inserts E19, E20 Available arbors and bolt E426~E428

AE(M)4000



AA
45°
• AR: 20°
• RR: -3°

(mm)

Designation	ØD	ØD1	ØD2	Ød	a	b	E	F	ap	kg	Fig.
AE (AEM) 4080R/L	80	103	60	25.4 (27)	9.5 (12.4)	6 (7)	25 (22)	50	5.5	1.7	1
4100R/L	100	122	80	31.75 (32)	12.7 (14.4)	8 (8)	32 (28)	50	5.5	2.9	2
4125R/L	125	146	100	38.1 (40)	15.9 (16.4)	10 (9)	38 (30)	63	5.5	4.4	2
4160R/L	160	181	120	50.8 (40)	19.0 (16.4)	11 (9)	38 (30)	63	5.5	6.1	2
4200R/L	200	220	130	47.625 (60)	25.4 (25.7)	13.5 (14)	38 (38)	63	5.5	8.9	3
4250R/L	250	270	180	47.625 (60)	25.4 (25.7)	13.5 (14)	38 (38)	63	5.5	15.7	3
4315R/L	315	335	240	47.625 (60)	25.4 (25.7)	13.5 (14)	38 (38)	63	5.5	25.1	4

() Metric size

Available inserts

	SECN	SEKN-SU	SEKR-MX			
Designation	Cermet	Coated			Uncoated	page
	CN2500 CN30	NCM325 NCM335 NCM335 NCM545 PC3700	PC6510 PC9540 PC3300 PC5400	ST30A G10 H01		
SECN 1203AFFN				● ●		
1203AFTN	● ●			●		
1203AFEN						
1203AFSN		● ●			E21	
1203AFEN-RH			● ●			
1203AFSN-RH						
1203AFTN-S20			●			
SEKN 1203AFSN-SU			●		E21	
SEKR 1203AFSN-MX		● ●	●		E22	

Available arbors

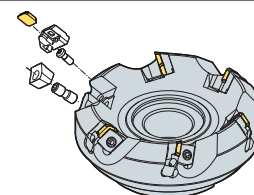
Designation	General arbor	NC arbors	
		ADN	ADNM
AE (AEM) 4080R/L	NT*□□ (MU)-FMA25.4-25	BT**□□-FMA25.4-□□	FMC27
4100R/L	NT*□□ (MU)-FMA31.75-□□	BT**□□-FMA31.75-□□	FMC32
4125R/L	NT*□□ (MU)-FMA38.1-□□	BT**□□-FMA38.1-□□	FMB40
4160R/L	NT*□□ (MU)-FMA50.8-□□	BT**□□-FMA50.8-□□	FMB40
4200R/L	NT*□□ (MU)-FMA47.625-25, KCP-8***	BT**□□-FMA47.625-□□	FMB60
4250R/L	NT*□□ (MU)-FMA47.625-25, KCP-8***	BT**□□-FMA47.625-□□	FMB60
4315R/L	KCP-8*** (Center ring plug)		

*□□-NT number **□□-BT number ***Over milling 5

Recommended cutting condition

Workpiece	Cutting condition		Grades
	vc (m/min)	fz (mm/t)	
P	190~320	0.05~0.20	NCM325 PC3700 ST30A
	161~270	0.05~0.20	
	80~140	0.05~0.20	
M	90~150	0.05~0.20	PC9530
K	140~230	0.05~0.30	PC6510 G10
	50~90	0.05~0.30	

Assembling

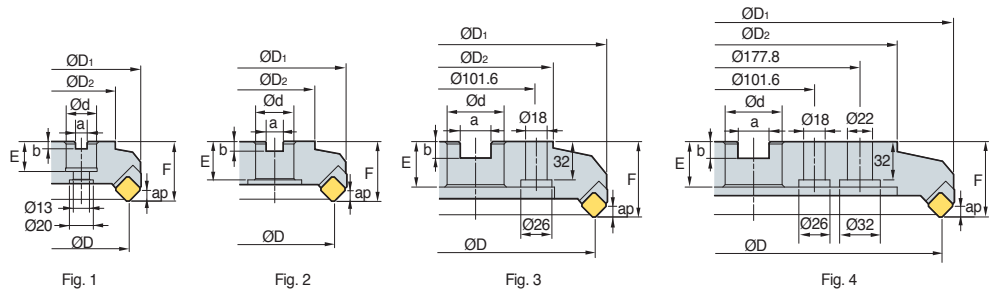


Parts

Specification					
Ø80-Ø315	LAE4R/L	WAE4R/L	DHA0821F	LTX0512	HW40

Available inserts E21, E22 Available arbors and bolt E426~E428

AE(M)5000



AA
45°
• AR: 20°
• RR: -3°

(mm)

Designation	⊙	ØD	ØD1	ØD2	Ød	a	b	E	F	ap	kg	Fig.
AE												
(AEM)												
5080R/L	4	80	103	60	25.4 (27)	9.5 (12.4)	6 (7)	25 (22)	50	7.5	1.7	1
5100R/L	5	100	122	80	31.75 (32)	12.7 (14.4)	8 (8)	32 (28)	50	7.5	2.9	2
5125R/L	6	125	146	100	38.1 (40)	15.9 (16.4)	10 (9)	38 (30)	63	7.5	4.4	2
5160R/L	8	160	181	120	50.8 (40)	19.0 (16.4)	11 (9)	38 (30)	63	7.5	6.1	2
5200R/L	10	200	220	130	47.625 (60)	25.4 (25.7)	13.5 (14)	38 (38)	63	7.5	8.9	3
5250R/L	12	250	270	180	47.625 (60)	25.4 (25.7)	13.5 (14)	38 (38)	63	7.5	15.7	3
5315R/L	15	315	335	240	47.625 (60)	25.4 (25.7)	13.5 (14)	38 (38)	63	7.5	25.1	4

() Metric size

Available inserts



Designation	Cermet		Coated							Uncoated		page				
	CN2500	CN30	NC5330	NCM325	NCM335	NCM535	NCM545	PC3700	PC6510	PC9530	PC9540		PC5300	PC5400	ST30A	G10
SECN 1504AFFN																
1504AFTN		●														
1504AFEN																
1504AFSN																E21
1504AFEN-RH																
1504AFSN-RH																
1504AFTN-S20																
SEKN 1504AFSN-SU																E21
1504AFSN-MX																
SEKR 1504AFSN-MX																E22

Available arbors

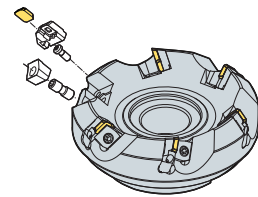
Designation	General arbor	NC arbors	
		AE	AEM
AE 5080R/L	NT*□□ (M/U)-FMA25.4-25	BT**□□ -FMA25.4-□□	FMC27
(AEM) 5100R/L	NT*□□ (M/U)-FMA31.75-□□	BT**□□ -FMA31.75-□□	FMC32
5125R/L	NT*□□ (M/U)-FMA38.1-□□	BT**□□ -FMA38.1-□□	FMB40
5160R/L	NT*□□ (M/U)-FMA50.8-□□	BT**□□ -FMA50.8-□□	FMB40
5200R/L	NT*□□ (M/U)-FMA47.625-25, KCP-8***	BT**□□ -FMA47.625-□□	FMB60
5250R/L	NT*□□ (M/U)-FMA47.625-25, KCP-8***	BT**□□ -FMA47.625-□□	FMB60
5315R/L	KCP-8*** (Center ring plug)		

*□□-NT number **□□-BT number ***Over milling 5

Recommended cutting condition

Workpiece	Cutting condition		Grades
	vc (m/min)	fz (mm/t)	
P	190~320	0.05~0.20	NCM325 PC3700 ST30A
	161~270	0.05~0.20	
	80~140	0.05~0.20	
M	90~150	0.05~0.20	PC9530
K	140~230	0.05~0.30	PC6510 G10
	50~90	0.05~0.30	

Assembling



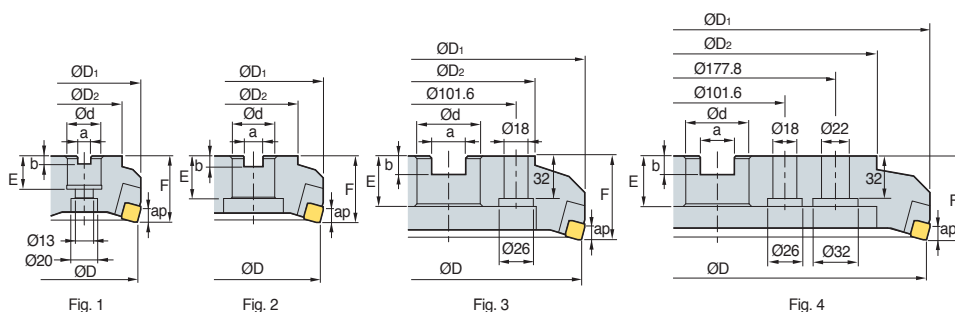
Parts

Specification	Locator	Wedge	Wedge screw	Locator screw	Wrench
Ø80~Ø315	LAE5R/L	WAE5R/L	DHA0821F	LTX0512	HW40

Available inserts E21, E22 Available arbors and bolt E426~E428



EF(M)4000



AA
75°
• AR: 18°
• RR: 11°

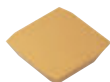
(mm)

Designation	⊙	ØD	ØD1	ØD2	Ød	a	b	E	F	ap	kg	Fig.	
EF (EFM)	4080R/L	4	80	89	57	25.4 (27)	9.5 (12.4)	6 (7)	25 (22)	50	8.0	1.5	1
	4100R/L	5	100	108	70	31.75 (32)	12.7 (14.4)	8 (8)	32 (28)	50	8.0	2.1	2
	4125R/L	6	125	133	87	38.1 (40)	15.9 (16.4)	10 (9)	38 (30)	63	8.0	3.8	2
	4160R/L	8	160	168	107	50.8 (40)	19.0 (16.4)	11 (9)	38 (30)	63	8.0	5.5	2
	4200R/L	10	200	208	130	47.625 (60)	25.4 (25.7)	13.5 (14)	38 (38)	63	8.0	8.2	3
	4250R/L	12	250	257	180	47.625 (60)	25.4 (25.7)	13.5 (14)	38 (38)	63	8.0	13.4	3
	4315R/L	16	315	322	240	47.625 (60)	25.4 (25.7)	13.5 (14)	38 (38)	63	8.0	21.2	4

() Metric size

Available inserts

SFCN



Designation	Cermet		Coated						Uncoated		page			
	CN2500	CN30	NC5330	NCM325	NCM535	NCM545	PC2010	PC3700	PC6510	PC9530		PC9540	PC5300	PC5400
SFCN 1203EFR													ST30A G10 H01	● E22

Available arbors

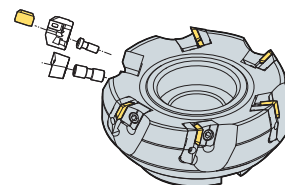
Designation	General arbor	NC arbors	
		EF	EFM
EF 4080R/L	NT*□□ (MU)-FMA25.4-25-□□	BT**□□-FMA25.4-□□	FMC27
(EFM) 4100R/L	NT*□□ (MU)-FMA31.75-□□	BT**□□-FMA31.75-□□	FMC32
4125R/L	NT*□□ (MU)-FMA38.1-□□	BT**□□-FMA38.1-□□	FMB40
4160R/L	NT*□□ (MU)-FMA50.8-□□	BT**□□-FMA50.8-□□	FMB40
4200R/L	NT*□□ (MU)-FMA47.625-25. KCP-8***	BT**□□-FMA47.625-□□	FMB60
4250R/L	NT*□□ (MU)-FMA47.625-25. KCP-8***	BT**□□-FMA47.625-□□	FMB60
4315R/L	KCP-8*** (Center ring plug)		

*□□-NT number **□□-BT number ***Over milling 5

Recommended cutting condition

Workpiece	Cutting condition		Grades
	vc (m/min)	fz (mm/t)	
K	75~125	0.05~0.30	H01

Assembling



Parts

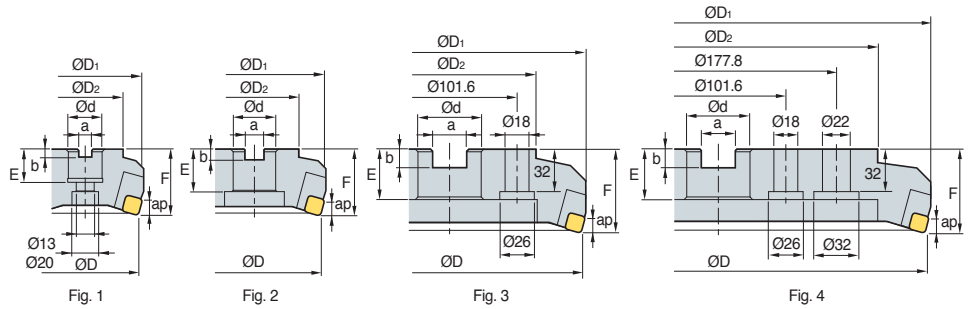
Specification					
Ø80-Ø315	LEF4R/L LEF4R1*/L1*	WEFR/L	DHA0821F	LTX0512	HW40

Available inserts E22 Available arbors and bolt E426~E428

* : Ø80~Ø125



EN(M)4000



Designation	ØD	ØD1	ØD2	Ød	a	b	E	F	ap	kg	Fig.	
EN 4080R/L	5	80	87	57	25.4 (27)	9.5 (12.4)	6 (7)	25 (22)	50	8.5	1.4	1
(ENM) 4100R/L	6	100	107	67	31.75 (32)	12.7 (14.4)	8 (8)	32 (28)	50	8.5	2.1	2
4125R/L	8	125	132	87	38.1 (40)	15.9 (16.4)	10 (9)	38 (30)	63	8.5	3.8	2
4160R/L	10	160	167	107	50.8 (40)	19.0 (16.4)	11 (9)	38 (30)	63	8.5	5.7	2
4200R/L	12	200	207	130	47.625 (60)	25.4 (25.7)	13.5 (14)	38 (38)	63	8.5	8.4	3
4250R/L	16	250	257	180	47.625 (60)	25.4 (25.7)	13.5 (14)	38 (38)	63	8.5	13.8	3
4315R/L	20	315	322	240	47.625 (60)	25.4 (25.7)	13.5 (14)	38 (38)	63	8.5	21.6	4

() Metric size

Available inserts

Designation	SNCN		SNKN		page
	Cermet	Coated	Uncoated		
SNCN 1204ENN	CN2500 CN30	NCM325 NCM535 NCM545 PC2010 PC3700 PC6510 PC9530 PC9540 PC5300 PC5400	ST30A G10 H01	●	E23
SNKN 1204ENN				●	E25

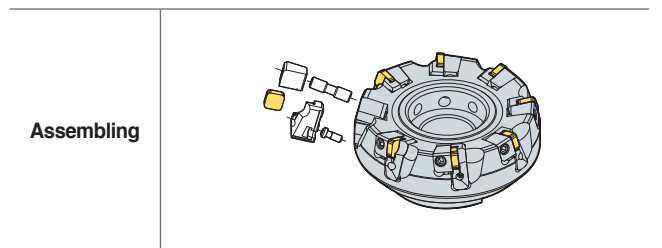
Available arbors

Designation	General arbor	NC arbors	
		EN	ENM
EF 4080R/L	NT*□□ (MU)-FMA25.4-25-□□	BT**□□ -FMA25.4-□□	FMC27
(EFM) 4100R/L	NT*□□ (MU)-FMA31.75-□□	BT**□□ -FMA31.75-□□	FMC32
4125R/L	NT*□□ (MU)-FMA38.1-□□	BT**□□ -FMA38.1-□□	FMB40
4160R/L	NT*□□ (MU)-FMA50.8-□□	BT**□□ -FMA50.8-□□	FMB40
4200R/L	NT*□□ (MU)-FMA47.625-25, KCP-8***	BT**□□ -FMA47.625-□□	FMB60
4250R/L	NT*□□ (MU)-FMA47.625-25, KCP-8***	BT**□□ -FMA47.625-□□	FMB60
4315R/L	KCP-8*** (Center ring plug)		

*□□-NT number **□□-BT number ***Over milling 5

Recommended cutting condition

Workpiece	Cutting condition		Grades
	vc (m/min)	fz (mm/t)	
P	190~320 161~270 80~140	0.05~0.20 0.05~0.20 0.05~0.20	NCM325 PC3700 ST30A
M	90~150	0.05~0.20	PC9530
K	140~230 50~90	0.05~0.30 0.05~0.30	PC6510 G10



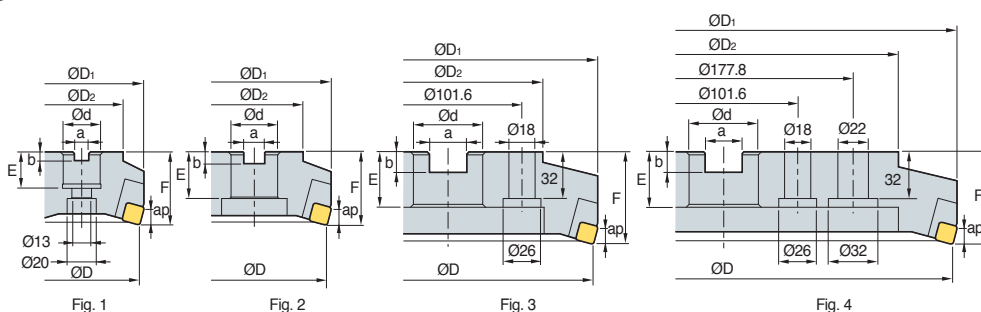
Parts

Specification	Locator	Wedge	Wedge screw	Locator screw	Wrench
Ø80~Ø315	LEN4R/L	WENR/L WENR1*/L1*	DHA0830 DHA0825*	LTX0512	HW40

* : Ø80-Ø100

Available inserts E23, E25 Available arbors and bolt E426-E428

EPN(M)4000



AA
75°
• AR: 7°
• RR: 0°

(mm)

Designation	ØD	ØD1	ØD2	Ød	a	b	E	F	ap	kg	Fig.	
EPN (EPNM) 4080R/L	5	80	86	57	25.4 (27)	9.5 (12.4)	6 (7)	25 (22)	50	9	1.4	1
4100R/L	6	100	107	67	31.75 (32)	12.7 (14.4)	8 (8)	32 (28)	50	9	2.1	2
4125R/L	8	125	132	87	38.1 (40)	15.9 (16.4)	10 (9)	38 (30)	63	9	3.8	2
4160R/L	10	160	166	107	50.8 (40)	19.0 (16.4)	11 (9)	38 (30)	63	9	5.7	2
4200R/L	12	200	206	130	47.625 (60)	25.4 (25.7)	14 (14)	38 (38)	63	9	8.2	3
4250R/L	16	250	256	180	47.625 (60)	25.4 (25.7)	14 (14)	38 (38)	63	9	13.5	3
4315R/L	20	315	321	240	47.625 (60)	25.4 (25.7)	14 (14)	38 (38)	63	9	21.1	4

() Metric size

Available inserts



Designation	Cermet		Coated							Uncoated		page				
	CN2500	CN30	NC5330	NCM325	NCM335	NCM535	NCM545	PC3700	PC6510	PC9530	PC9540		PC5300	PC5400	ST30A	G10
SPCN 1203EDR	●		●	●										●	●	●
1203EDL														●		
1203EDR-G																●
1203EDER-RH								●		●						
1203EDSR-RH								●								
1203EDTR-RH																
1203EDR-S20									●							
SPKN 1203EDSR-MU								●								
1203EDSR-SU								●			●	●				
1203EDSL-SU								●								
SPKR 1203EDSR-MX			●	●												
1203EDSL-MX			●	●												
SPEX 1203EDR/L-1																

Available arbors

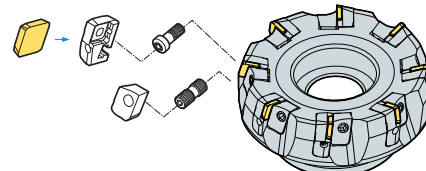
Designation	General arbor	NC arbors	
		EPN	EPNM
EPN (EPNM) 4080R/L	NT*□□ (MU)-FMA25.4-25	BT**□□-FMA25.4-□□	FMC27
4100R/L	NT*□□ (MU)-FMA31.75-□□	BT**□□-FMA31.75-□□	FMC32
4125R/L	NT*□□ (MU)-FMA38.1-□□	BT**□□-FMA38.1-□□	FMB40
4160R/L	NT*□□ (MU)-FMA50.8-□□	BT**□□-FMA50.8-□□	FMB40
4200R/L	NT*□□ (MU)-FMA47.625-25, KCP-8***	BT**□□-FMA47.625-□□	FMB60
4250R/L	NT*□□ (MU)-FMA47.625-25, KCP-8***	BT**□□-FMA47.625-□□	FMB60
4315R/L	KCP-8*** (Center ring plug)		

*□□-NT number **□□-BT number ***Over milling 5

Recommended cutting condition

Workpiece	Cutting condition		Grades
	vc (m/min)	fz (mm/t)	
P	190~320	0.05~0.20	NCM325 PC3700 ST30A
	161~270	0.05~0.20	
	80~140	0.05~0.20	
M	90~150	0.05~0.20	PC9530
K	140~230	0.05~0.30	PC6510 G10
	50~90	0.05~0.30	

Assembling



Parts

Specification	Locator	Wedge	Wedge screw	Locator screw	Wrench
Ø80~Ø315	LEPN4R/L LEPN4R1*/L1*	WEPN4R/L	DHA0821F DHA0817F*	LTX0514	HW40

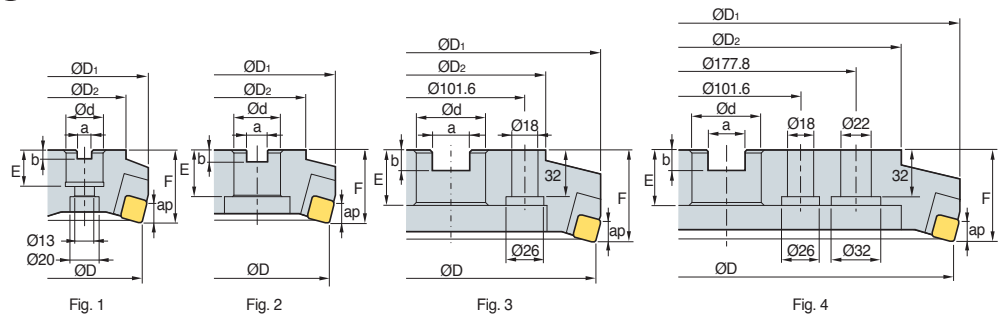
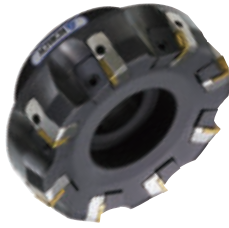
Available inserts E26, E27

Available arbors and bolt E426~E428

* : Ø80~Ø100



EPN(M)5000+



(mm)

Designation	ØD	ØD1	ØD2	Ød	a	b	E	F	ap	kg	Fig.
EPN 5080R/L+	80	91	60	25.4 (27)	9.5 (12.4)	6 (7)	25 (22)	63	12	1.7	1
(EPNM) 5100R/L+	100	110	70	31.75 (32)	12.7 (14.4)	8 (8)	32 (28)	63	12	2.5	1
5125R/L+	125	134	90	38.1 (40)	15.9 (16.4)	10 (9)	38 (30)	63	12	3.8	2
5160R/L+	160	169	110	50.8 (40)	19.0 (16.4)	11 (9)	38 (30)	63	12	5.5	2
5200R/L+	200	209	150	47.625 (60)	25.4 (25.7)	14 (14)	38 (38)	63	12	8.0	3
5250R/L+	250	259	230	47.625 (60)	25.4 (25.7)	14 (14)	38 (38)	63	12	14.8	3
5315R/L+	315	324	270	47.625 (60)	25.4 (25.7)	14 (14)	38 (38)	63	12	22.4	4

() Metric size

Available inserts



Designation	Cermet		Coated						Uncoated		page			
	CN2500 CN30	NC5330	NCM325	NCM535	NCM545	PC2010	PC3700	PC6510	PC9530	PC9540		PC5300	PC5400	ST30A G10 H01
SPCN 150412T														
1504EDR	●	●											●	●
1504EDSR														
1504EDL								●						
1504EDR-G													●	E26
1504EDER-RH								●	●					
1504EDSR-RH								●						
1504EDTR-RH														
1504EDR-S20										●				
SPKN 1504EDSR-MU										●				
1504EDSR-SU										●	●			E27
1504EDSL-SU										●				
SPKR 1504EDR-MX			●											E27
1504EDSR-MX														
SPEX 1504EDR/L-1														E26

Available arbors

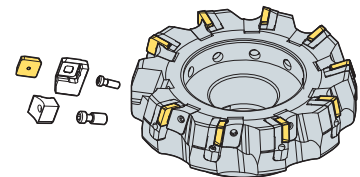
Designation	General arbor	NC arbors	
		EPN	EPNM
EPN 5080R/L+	NT*(M/U)-FMA25.4-25	BT**-(M/U)-FMA25.4-□□	FMC27
(EPNM) 5100R/L+	NT*(M/U)-FMA31.75-□□	BT**-(M/U)-FMA31.75-□□	FMC32
5125R/L+	NT*(M/U)-FMA38.1-□□	BT**-(M/U)-FMA38.1-□□	FMB40
5160R/L+	NT*(M/U)-FMA50.8-□□	BT**-(M/U)-FMA50.8-□□	FMB40
5200R/L+	NT*(M/U)-FMA47.625-25, KCP-8***	BT**-(M/U)-FMA47.625-□□	FMB60
5250R/L+	NT*(M/U)-FMA47.625-25, KCP-8***	BT**-(M/U)-FMA47.625-□□	FMB60
5315R/L+	KCP-8*** (Center ring plug)		

*□□-NT number **□□-BT number ***Over milling 5

Recommended cutting condition

Workpiece	Cutting condition		Grades
	vc (m/min)	fz (mm/t)	
P	190~320	0.05~0.20	NCM325 PC3700 ST30A
	161~270	0.05~0.20	
	80~140	0.05~0.20	
M	90~150	0.05~0.20	PC9530
K	140~230	0.05~0.30	PC6510 G10
	50~90	0.05~0.30	

Assembling



Parts

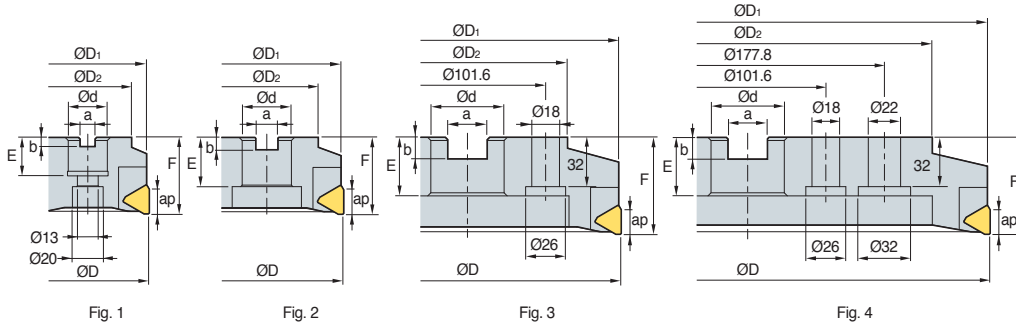
Specification	Locator	Wedge	Wedge screw	Locator screw	Wrench
Ø80~Ø315	LEPN5R/L LEPN5R1*/L1*	WHPS5R/L	WHX0817 WHX0813*	LTX0514	HW40

* : Ø80

Available inserts E26, E27 Available arbors and bolt E426~E428



PF(M)4000



• AR: 15°
• RR: 14°

(mm)

Designation		ØD	ØD1	ØD2	Ød	a	b	E	F	ap		Fig.	
PF (PFM)	4080R/L	4	80	79	57	25.4 (27)	9.5 (12.4)	6 (7)	25 (22)	50	1.2	1	
	4100R/L	4	100	97	67	31.75 (32)	12.7 (14.4)	8 (8)	32 (28)	50	1.8	2	
	4125R/L	7	125	122	87	38.1 (40)	15.9 (16.4)	10 (9)	38 (30)	63	3.1	2	
	4160R/L	9	160	158	107	50.8 (40)	19.0 (16.4)	11 (9)	38 (30)	63	5.6	2	
	4200R/L	11	200	197	130	47.625 (60)	25.4 (25.7)	13.5 (14)	38 (38)	63	16	8.8	3
	4250R/L	15	250	247	180	47.625 (60)	25.4 (25.7)	13.5 (14)	38 (38)	63	16	16	3
	4315R/L	19	315	311	240	47.625 (60)	25.4 (25.7)	13.5 (14)	38 (38)	63	16	22	4

() Metric size

Available inserts

TFCN



Designation	Cermet		Coated						Uncoated		page					
	CN2500	CN30	NC5330	NCM925	NCM635	NCM645	PC2010	PC3700	PC6510	PC9530		PC9540	PC5300	PC5400	ST30A	G10
TFCN 2203PFR																
2203PFL																E28

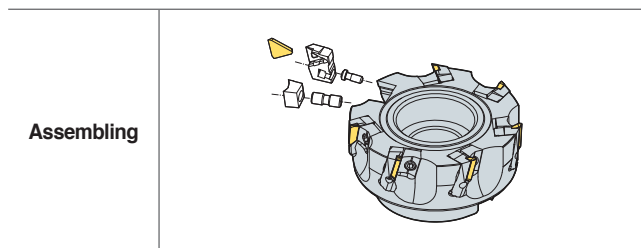
Available arbors

Designation	General arbor	NC arbors		
		PF	PFM	
PF (PFM)	4080R/L	NT*□□ (M/U)-FMA25.4-25	BT**□□-FMA25.4-□□	FMC27
	4100R/L	NT*□□ (M/U)-FMA31.75-□□	BT**□□-FMA31.75-□□	FMC32
	4125R/L	NT*□□ (M/U)-FMA38.1-□□	BT**□□-FMA38.1-□□	FMB40
	4160R/L	NT*□□ (M/U)-FMA50.8-□□	BT**□□-FMA50.8-□□	FMB40
	4200R/L	NT*□□ (M/U)-FMA47.625-25, KCP-8***	BT**□□-FMA47.625-□□	FMB60
	4250R/L	NT*□□ (M/U)-FMA47.625-25, KCP-8***	BT**□□-FMA47.625-□□	FMB60
	4315R/L	KCP-8*** (Center ring plug)		

*□□-NT number **□□-BT number ***Over milling 5

Recommended cutting condition

Workpiece	Cutting condition		Grades
	vc (m/min)	fz (mm/t)	
P	190~320	0.05~0.20	NCM325 PC3700 ST30A
	161~270	0.05~0.20	
	80~140	0.05~0.20	
M	90~150	0.05~0.20	PC9530
K	140~230	0.05~0.30	PC6510 G10
	50~90	0.05~0.30	



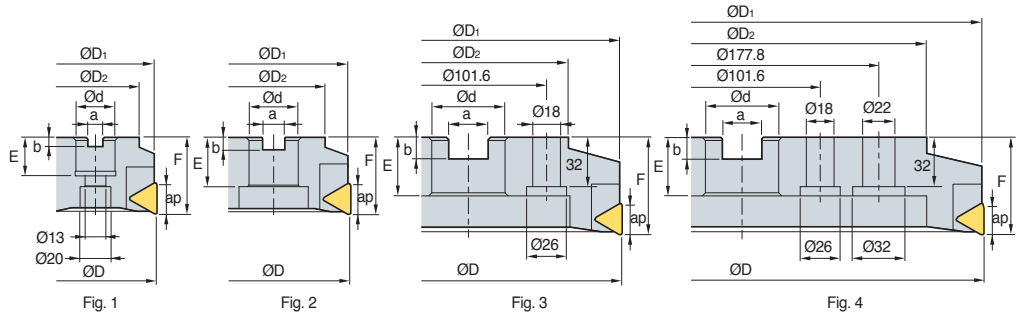
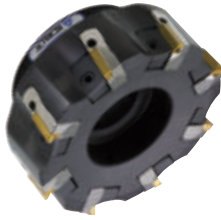
Parts

Specification					
Ø80~Ø315	LPF4R/L LPF4R1**/L1**	WPR/L	DHA0821F DHA0817F*	LTX0512	HW40

Available inserts E28 Available arbors and bolt E426~E428

* : Ø80~Ø100 / ** : Ø80~Ø125

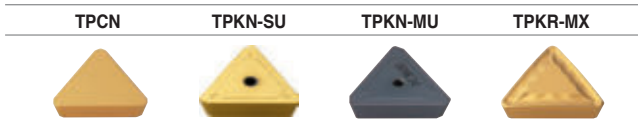
PPN(M)4000



Designation		⊙	ØD	ØD1	ØD2	Ød	a	b	E	F	ap	kg	Fig.
PPN (PPNM)	4080R/L	5	80	79	57	25.4 (27)	9.5 (12.4)	6 (7)	25 (22)	50	18	1.3	1
	4100R/L	6	100	99	67	31.75 (32)	12.7 (14.4)	8 (8)	32 (28)	50	18	1.9	2
	4125R/L	8	125	124	87	38.1 (40)	15.9 (16.4)	10 (9)	38 (30)	63	18	3.5	2
	4160R/L	10	160	158	107	50.8 (40)	19.0 (16.4)	11 (9)	38 (30)	63	18	5.6	2
	4200R/L	12	200	198	130	47.625 (60)	25.4 (25.7)	14 (14)	38 (38)	63	18	8.1	3
	4250R/L	16	250	248	180	47.625 (60)	25.4 (25.7)	14 (14)	38 (38)	63	18	13.3	3
	4315R/L	20	315	313	240	47.625 (60)	25.4 (25.7)	14 (14)	38 (38)	63	18	21.4	4

() Metric size

Available inserts



Designation	Cermet	Coated						Uncoated		page
		CN2500 CN30	NCM325 NCM330	NCM325 NCM335	NCM535 NCM545	PC3700	PC6510 PC9530 PC9540	PC5300 PC5400	ST30A G10 H01	
TPCN	2204PDR	●	●					●	●	E28
	2204PDR-G								●	
	2204PDL								●	
	2204PDSR		●							
	2204PDTR									
	2204PDR-RH									
	2204PDER-RH					●	●			
TPKN	2204PDSR-MU					●				E29
	2204PDSR-SU					●	●	●		
	2204PDSL-SU					●				
TPKR	2204PDR-MX		●							E29
	2204PDSR-MX		●	●						
	2204PPR-MX									

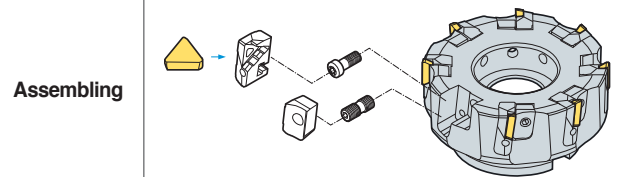
Available arbors

Designation	General arbor	NC arbors	
		PPN	PPNM
PPN 4080R/L	NT*□□ (M/U)-FMA25.4-25	BT**□□-FMA25.4-□□	FMC27
PPNM 4100R/L	NT*□□ (M/U)-FMA31.75-□□	BT**□□-FMA31.75-□□	FMC32
4125R/L	NT*□□ (M/U)-FMA38.1-□□	BT**□□-FMA38.1-□□	FMB40
4160R/L	NT*□□ (M/U)-FMA50.8-□□	BT**□□-FMA50.8-□□	FMB40
4200R/L	NT*□□ (M/U)-FMA47.625-25, KCP-8***	BT**□□-FMA47.625-□□	FMB60
4250R/L	NT*□□ (M/U)-FMA47.625-25, KCP-8***	BT**□□-FMA47.625-□□	FMB60
4315R/L	KCP-8*** (Center ring plug)		

*□□-NT number **□□-BT number ***Over milling 5

Recommended cutting condition

Workpiece	Cutting condition		Grades
	vc (m/min)	fz (mm/t)	
P	190~320	0.05~0.20	NCM325 PC3700 ST30A
	161~270	0.05~0.20	
	80~140	0.05~0.20	
M	90~150	0.05~0.20	PC9530
K	140~230	0.05~0.30	PC6510 G10
	50~90	0.05~0.30	



Parts

Specification	Locator	Wedge	Wedge screw	Locator screw	Wrench
Ø80~Ø315	LPPN4R/L LPPN4R1*/L1*	WPPN4R/L	DHA0821F DHA0817F*	LTX0514	HW40

* : Ø80~Ø100

Available inserts E28, E29 Available arbors and bolt E426~E428



Highly rigid inserts for roughing

Mill-max Heavy new

- Productivity - Cutting time is reduced by the cutting-edge design specialized for rough facing at high depth of cuts
- High rigidity - The highly rigid inserts and cutter seams prevent tool breakage in rough facing
- Clamping stability- The wedge-type clamping system, which is easy-to-use and strong, reduces time for replacing inserts, and improves clamping stability

Features of insert

- **Highly rigid inserts**
- Ideally suited for roughing at high depth of cuts
- **Wide chip pocket area**
- Improved chip evacuation
- Reduced cutting loads
- **Minor cutting-edge**
- Improved surface finish thanks to the wiper function

• **Major cutting-edge**
- High rake angle

• **2-level flank relief surface**
- Relief angle availability even at high feed rates

MAX. ap
SCKN22: 10.5 mm
SCKN28: 14.5 mm

Features of chip breakers

Insert	Cutting-edge	Uses	Features
MM		For roughing	Highly rigid chip breaker ideally suited for roughing at high depth of cuts

Features of cutter

- **Cutter seams**
- Prevent cutter breakage even under harsh cutting conditions
- **Wide chip pockets**
- Improve chip evacuation

• **Wedge-type clamping system**
- Provides clamping stability
- Reduces time for replacing inserts

Recommended cutting condition

	Workpiece	Grades	Cutting condition		
			vc (m/min)	fz (mm/t)	ap (mm)
P	Low carbon steel/Mild steel	PC5300, NC5340, NCM535	140~270	0.2~0.4	2.0~10.0 [SCKN22], 3.0~14.0 [SCKN28]
	High carbon steel	PC5300, NC5340, NCM535	100~220	0.2~0.4	2.0~10.0 [SCKN22], 3.0~14.0 [SCKN28]
	Alloy steel	PC5300, NC5340, NCM535	100~180	0.2~0.4	2.0~10.0 [SCKN22], 3.0~14.0 [SCKN28]
M	Stainless steel	PC5300, NC5340, NCM535	90~180	0.2~0.4	2.0~10.0 [SCKN22], 3.0~14.0 [SCKN28]
K	Cast iron	PC5300, NC5340, NCM535	100~180	0.2~0.4	2.0~10.0 [SCKN22], 3.0~14.0 [SCKN28]

HDDCM 7000/9000 new

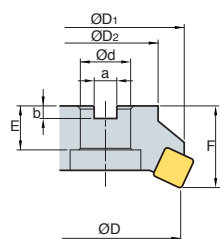


Fig. 1

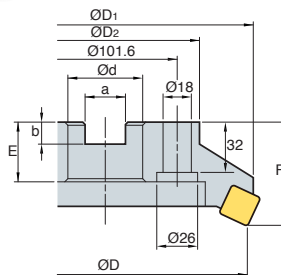


Fig. 2

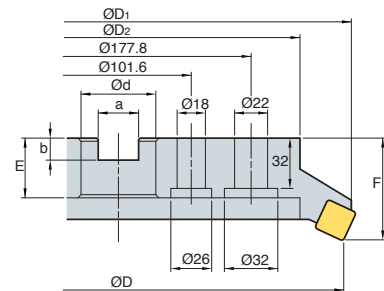


Fig. 3



AA
55°
• AR: 15°
• RR: 5°

(mm)

Designation		ØD	ØD1	ØD2	Ød	a	b	E	F	ap		Fig.	
HDDCM	7125R/L-5	5	125	135.6	90	40	16.4	9	32	63	10.5	3.43	1
	7160R/L-6	6	160	169.8	110	40	16.4	9	32	63	10.5	4.89	2
	7160R/L-8	8	160	169.8	110	40	16.4	9	32	63	10.5	4.62	2
	7200R/L-8	8	200	209.2	130	60	25.7	14	38	80	10.5	8.49	2
	7200R/L-10	10	200	209.2	130	60	25.7	14	38	80	10.5	8.74	2
	7250R/L-10	12	250	258.6	180	60	25.7	14	38	80	10.5	13.44	2
	7250R/L-12	10	250	258.6	180	60	25.7	14	38	80	10.5	13.41	2
	7315R/L-12	12	315	323.2	240	60	25.7	14	38	80	10.5	21.69	3
HDDCM	7315R/L-14	14	315	323.2	240	60	25.7	14	38	80	10.5	21.41	3
	9125R/L-5	5	125	140.4	90	40	16.4	9	32	63	14.5	3.4	1
	9160R/L-6	6	160	177.6	110	40	16.4	9	32	80	14.5	6.39	2
	9200R/L-8	8	200	213.6	130	60	25.7	14	38	80	14.5	8.76	2
	9250R/L-10	10	250	265	180	60	25.7	14	38	80	14.5	13.84	2
	9250R/L-12	12	250	265	180	60	25.7	14	38	80	14.5	13.41	2
	9315R/L-12	12	315	327.4	240	60	25.7	14	38	80	14.5	21.02	3

Available inserts

SCKN-MM



Designation	Cement		Coated						Uncoated		page	
	CN2500	CN30	NCM325	NCM535	NCM545	PC2010	PC3700	PC6510	PC9530	PC9540		PC5300
7000 type SCKN 220715DDSR-MM			●	●								
9000 type SCKN 280920DDSR-MM												

Recommended cutting condition

Workpiece	Cutting condition		Grades
	vc (m/min)	fz (mm/t)	
P	140~270 100~220 100~180	0.2~0.4	NC5340 NCM535
M	90~180		
K	100~180		

Available arbors

Designation	General arbor
HDDCM 7125R/L-5	NT*□□(M/U)-FMC40
7160R/L-6	
7160R/L-8	
7200R/L-8	NT*□□(M/U)-FMC60
7200R/L-10	
7250R/L-10	
7250R/L-12	
7315R/L-12	
7315R/L-14	NT*□□(M/U)-FMC40
9125R/L-5	
9160R/L-6	
9200R/L-8	
9250R/L-10	
9250R/L-12	
9315R/L-12	

*□□-NT number **□□-BT number ***Over milling 5

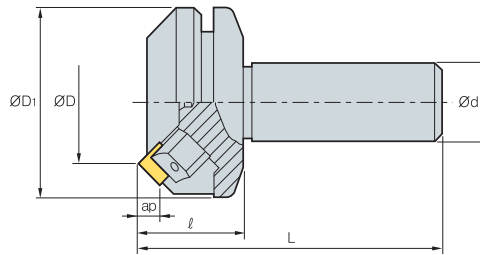
Parts

Specification					
Ø125~Ø315 (7000 type)	WHD7R/L	WHX0817	SS64DPR	FTGA0614	HW40
Ø125~Ø315 (9000 type)	WHD9R/L	WHX0817	SS84DPR	FTGA0818	HW40

Available inserts E19 Available arbors and bolt E426~E428



ADS4000



AA
45°
• AR: 15°
• RR: -3°

(mm)

Designation		ØD	ØD1	Ød	ℓ	L	ap	
ADS	4050R/L	3	50	75	32	40	120	1.8
	4050R/L-S42	3	50	75	42	40	120	2.2
	4063R/L	4	63	87	32	40	120	2.3
	4063R/L-S42	4	63	87	42	40	120	2.7

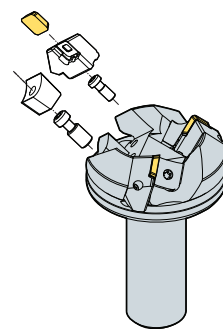
Available inserts

		SDCN	SDKN-MU	SDKN-SU	SDKR-MX		
Designation	page	Cermet	Coated			Uncoated	
		CN2500 CN30	NC5330 NCM325 NCM335 NCM535 NCM545 PC3700 PC6510 PC9530 PC9540 PC5300 PC5400	ST30A G10 H01			
SDCN 42M							
42M-G							
42MT		●	●			●	
42MT-RH							
42MT-S20	E19				●		
1203AEEN							
1203AEEN-RH							
1203AESN							
1203AESN-RH							
SDKN 1203AESN-MU	E20			●			
1203AESN-SU				●	●	●	
SDKR 1203AESN-MX							
1203AETN-MX	E20						
1203AEN-MX			●				

Recommended cutting condition

Workpiece	Cutting condition		Grades
	vc (m/min)	fz (mm/t)	
P	190~320	0.05~0.20	NCM325 PC3700 ST30A
	161~270	0.05~0.20	
	80~140	0.05~0.20	
M	90~150	0.05~0.20	PC9530
K	140~230	0.05~0.30	PC6510 G10
	50~90	0.05~0.30	

Assembling

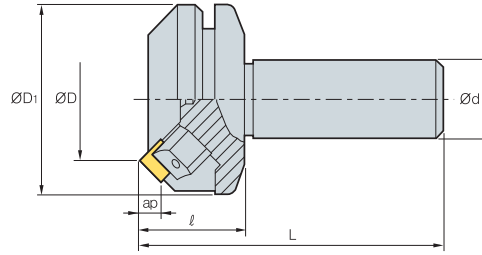


Parts

Specification					
Ø50~Ø63	LASS4R/L	WASR/L	WTX0817	LTX0512	TW25

Available inserts E19, E20

ADS5000



AA
45°
• AR: 15°
• RR: -3°

(mm)

Designation			ØD	ØD1	Ød	l	L	ap	
ADS	5050R/L	3	50	75	32	40	120	8.5	1.9
	5050R/L-S42	3	50	75	42	40	120	8.5	2.3
	5063R/L	4	63	87	32	40	120	8.5	2.4
	5063R/L-S42	4	63	87	42	40	120	8.5	2.8

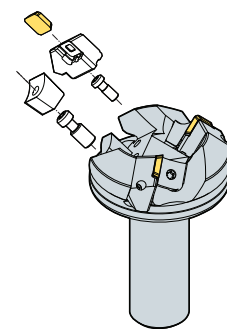
Available inserts

		SDCN	SDKN-MU	SDKN-SU	SDKR-MX			
Designation	page	Cermet	Coated				Uncoated	
		CN2500 CN30	NC5330 NCM325 NCM335 NCM535 NCM545	PC3700 PC6510 PC9530 PC9540 PC5300 PC5400	ST30A G10 H01			
SDCN 53M							●	
53M-G								●
53MT		●	●				●	
53MT-RH								
53MT-S20	E19				●			
1504AEEN								
1504AEEN-RH					●	●		
1504AESN								
1504AESN-RH					●			
SDKN 1504AESN-MU					●			
1504AESN-SU	E20			●		●	●	
SDKR 1504AESN-MX			●					
1504AETN-MX	E20							
1504AEN-MX			●					

Recommended cutting condition

Workpiece	Cutting condition		Grades
	vc (m/min)	fz (mm/t)	
P	190~320	0.05~0.20	NCM325 PC3700 ST30A
	161~270	0.05~0.20	
	80~140	0.05~0.20	
M	90~150	0.05~0.20	PC9530
K	140~230	0.05~0.30	PC6510 G10
	50~90	0.05~0.30	

Assembling



Parts

Specification					
Ø50-Ø63	LASS5R/L	WASR/L	WTX0817	LTX0512	TW25

Available inserts E19, E20

PES2000/3000/4000



2000/3000 type

4000 type

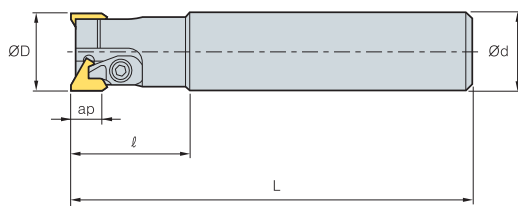


Fig. 1

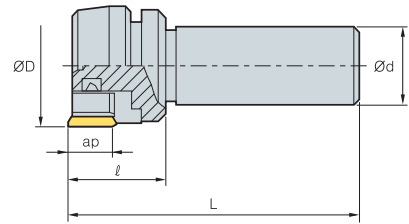
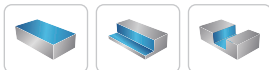


Fig. 2



AA
90°

- AR: 10°~15°
- RR: 2°~3°

(mm)

Designation		ØD	Ød	l	L	ap		Fig.	
PES	2020R/L	2	20	20	30	110	0.3	1	
	2025R/L	2	25	25	35	120	0.5	1	
	3030R/L	2	30	32	45	160	0.9	1	
	3032R/L	2	32	32	45	160	1.0	1	
	3033R/L	2	33	32	45	160	1.1	1	
	3035R/L	2	35	32	45	160	1.2	1	
	3036R/L	2	36	32	45	160	1.3	1	
	3040R/L	2	40	32	45	160	1.4	1	
	4050R/L	3	50	32	40	120	16.5	1.2	2
	4050R/L-S42	3	50	42	40	120	16.5	1.5	2
	4063R/L	4	63	32	40	120	16.5	1.5	2
	4063R/L-S42	4	63	42	40	120	16.5	1.8	2

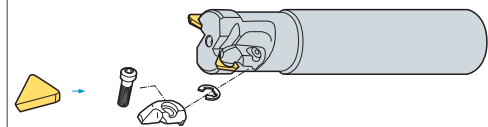
Available inserts

		TECN	TEEN																	
Designation		Cermet		Coated				page												
		CN2500	CN30	NC5330	NCM325	NCM335	NCM535		NCM545	PC3700	PC6510	PC9530	PC9540	PC5300	PC5400	ST30A	G10	H01		
2000 type	TECN 22R																			
	22TR		●																	E27
3000 type	TECN 32R																			
	32TR		●																	
	32TR-S20										●									E27
4000 type	TEEN 43R																			
	43R-G																			
	43TR		●	●																
	43TR-S20																			
	43TR-Z																			
	43TR-ZH																			

Recommended cutting condition

Workpiece	Cutting condition		Grades
	vc (m/min)	fz (mm/t)	
P	190~320	0.05~0.20	NCM325 PC3700 ST30A
	161~270	0.05~0.20	
	80~140	0.05~0.20	
M	90~150	0.05~0.20	PC9530
K	140~230	0.05~0.30	PC6510 G10
	50~90	0.05~0.30	

Assembling

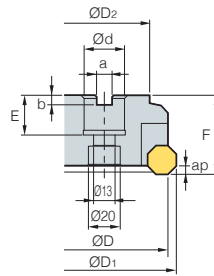


Parts

Specification								
Ø20~Ø25 (2000 type)	-	-	-	CHX0407	HW25L	-	CH4R1	ER03
Ø30~Ø40 (3000 type)	-	-	-	CHX0510	HW30L	-	CH5R1	ER04
Ø50~Ø63 (4000 type)	LPTS4R/L	WPTSR	DHA0815	LTX0512	-	HW40	-	-

Available inserts E27

AFO(M)4000



AA
45°
• AR: 15°
• RR: 5°

(mm)

Designation		ØD	ØD1	ØD2	Ød	a	b	E	F	ap		
AFO	4080R/L	5	80	88	60	25.4 (27)	9.5 (12.4)	6 (7)	25 (22)	50	3.3	1.4
(AFOM)	4100R/L	6	100	108	80	31.75 (32)	12.7 (14.4)	8 (8)	32 (28)	50	3.3	2.0
	4125R/L	8	125	133	100	38.1 (40)	15.9 (16.4)	10 (9)	38 (30)	63	3.3	3.1

() Metric size

Available inserts

	OFCW	OFKT-MF	OFKT-MM	OFKT-MA		
Designation	Cermet	Coated			Uncoated	page
	CN2500 CN30	NC5330 NCM325 NCM535 NCM545	PC2010 PC3700 PC6510 PC9530 PC9540 PC5300 PC5400	ST30A G10 H01		
OFCW	05T3SN 05T3FN 05T308FN					E14
OFKT	05T3SN-MF 05T308SN-MF 05T3SN-MM 05T308SN-MM 05T3FN-MA 05T3EN-MA		● ● ● ●		●	E14 E15

Available arbors

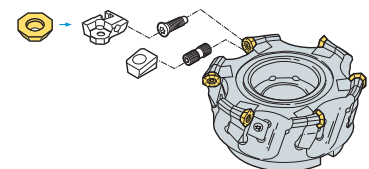
Designation	General arbor	NC arbors		
		AFO	AFOM	
AFO	4080R/L	NT*□□(M/U)-FMA25.4-25	BT**□□-FMA25.4-□□	FMC27
(AFOM)	4100R/L	NT*□□(M/U)-FMA31.75-□□	BT**□□-FMA31.75-□□	FMC32
	4125R/L	NT*□□(M/U)-FMA38.1-□□	BT**□□-FMA38.1-□□	FMB40

*□□-NT number **□□-BT number ***Over milling 5

Recommended cutting condition

Workpiece	Cutting condition		Grades
	vc (m/min)	fz (mm/t)	
P	190~320	0.05~0.20	NCM325 PC3700 ST30A
	161~270	0.05~0.20	
	80~140	0.05~0.20	
M	90~150	0.05~0.20	PC9530
K	140~230	0.05~0.30	PC6510 G10
	50~90	0.05~0.30	

Assembling



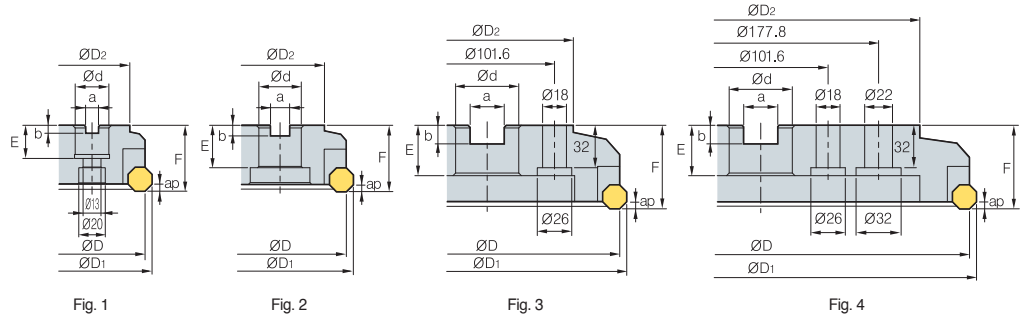
Parts

Specification					
Ø80~Ø125	LAF04R/L	WAFO4R/L	DHA0815	FTKA0408	TW15S

Available inserts E14, E15 Available arbors and bolt E426~E428



AFO(M)5000



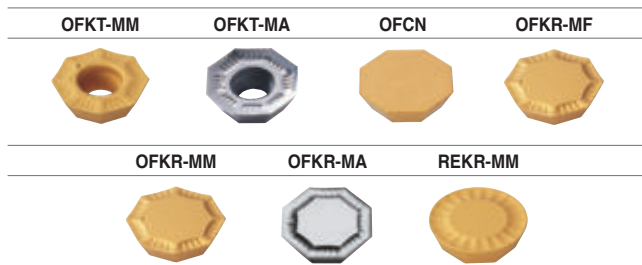
AA
45°
• AR: 15°
• RR: 5°

(mm)

Designation	ØD	ØD1	ØD2	Ød	a	b	E	F	ap	kg	Fig.
AFO 5080R/L	80	91	60	25.4 (27)	9.5 (12.4)	6 (7)	25 (22)	50	4.8	1.4	1
(AFOM) 5100R/L	100	111	80	31.75	12.7 (14.4)	8 (8)	32 (28)	50	4.8	2.0	2
5125R/L	125	136	100	38.1 (40)	15.9 (16.4)	10 (9)	38 (30)	63	4.8	3.1	2
5160R/L	160	171	120	50.8 (40)	19.0 (16.4)	11 (9)	38 (30)	63	4.8	5.2	2
5200R/L	200	211	130	47.625 (60)	25.4 (25.7)	13.5 (14)	38 (38)	63	4.8	7.5	3
5250R/L	250	261	180	47.625 (60)	25.4 (25.7)	13.5 (14)	38 (38)	63	4.8	16.1	3
5315R/L	315	326	240	47.625 (60)	25.4 (25.7)	13.5 (14)	38 (38)	63	4.8	22.8	4

() Metric size

Available inserts



Designation	Cermet	Coated										Uncoated	page
	CN2500 CN30	NC5330 NCM325	NCM335	NCM535	NCM545	PC3700	PC6510	PC9530	PC9540	PC5300	PC5400	ST30A G10 H01	
OFCN 0704SN						●							E14
0704FN													
070408SN													
070408FN													
OFKR 0704SN-MF		●●											E14
070408SN-MF													
0704SN-MM		●●	●●	●●	●●	●							
070408SN-MM		●											
0704FN-MA												●	
0704EN-MA													
OFKT 0704SN-MM													E14
0704FN-MA													
0704EN-MA													
REKR 170400-MM													E17

Available arbors

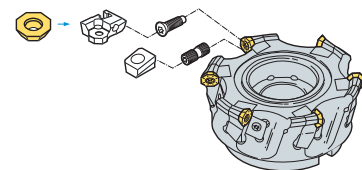
Designation	General arbor	NC arbors	
		AFO	AFOM
AFO 5080R/L	NT*□□ (M/U)-FMA25.4-25	BT**□□-FMA25.4-□□	FMC27
(AFOM) 5100R/L	NT*□□ (M/U)-FMA31.75-□□	BT**□□-FMA31.75-□□	FMC32
5125R/L	NT*□□ (M/U)-FMA38.1-□□	BT**□□-FMA38.1-□□	FMB40
5160R/L	NT*□□ (M/U)-FMA50.8-□□	BT**□□-FMA50.8-□□	FMB40
5200R/L	NT*□□ (M/U)-FMA47.625-25, KCP-8***	BT**□□-FMA47.625-□□	FMB60
5250R/L	NT*□□ (M/U)-FMA47.625-25, KCP-8***	BT**□□-FMA47.625-□□	FMB60
5315R/L	KCP-8*** (Center ring plug)		

*□□-NT number **□□-BT number ***Over milling 5

Recommended cutting condition

Workpiece	Cutting condition		Grades
	vc (m/min)	fz (mm/t)	
P	190~320	0.05~0.20	NCM325 PC3700 ST30A
	161~270	0.05~0.20	
	80~140	0.05~0.20	
M	90~150	0.05~0.20	PC9530
K	140~230	0.05~0.30	PC6510 G10
	50~90	0.05~0.30	

Assembling



Parts

Specification	Locator	Wedge	Wedge screw	Locator screw	Wrench
Ø80~Ø315	LAF05R/L LAF05R*/L-1*	WEFR/L	DHA0821F	LTX0512	HW40

Available inserts E14~E17

Available arbors and bolt E426~E428

*: Ø80-Ø100



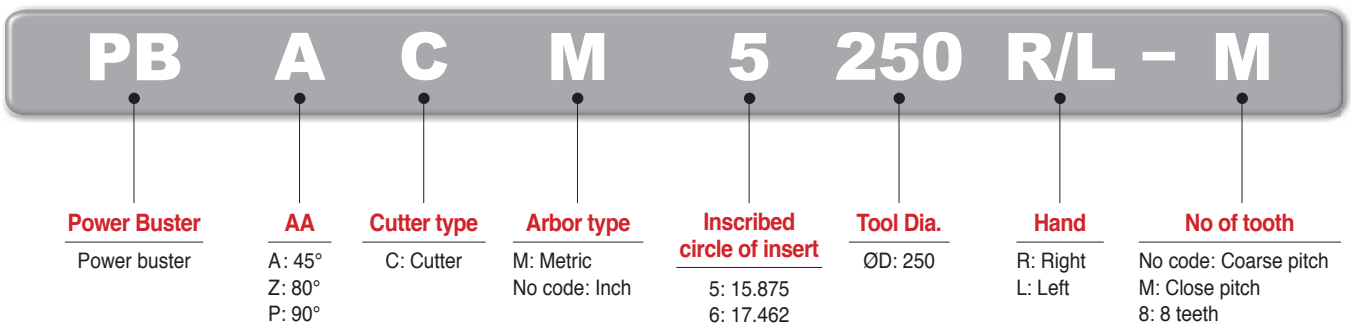
E Technical Information for Power Buster

New serrated edge design increases productivity by reducing insert cutting load

Power Buster

- New tooling utilizing a specially designed serrated edge to increase productivity by reducing the cutting load.
- Double-sided 6 corner insert geometry ensures high rigidity, long tool life and cost efficiency
- The serrated edge divides the chips into smaller pieces. This feature provides excellent chip control, reduces interference of the cutter and ensures good durability of the cutter body.
- Two types of inserts are available-TNMX27 for PBA (Approach angle: 45°) and PBZ (AA: 80°), and TNMX30 for PBP (AA: 90°)
- Application: High depth of cut and feed rate (Steel, Cast iron)

Code system

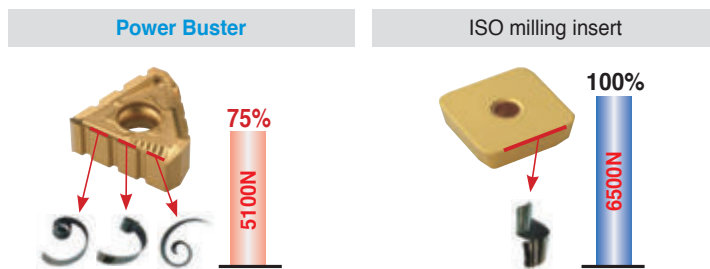


Features of insert

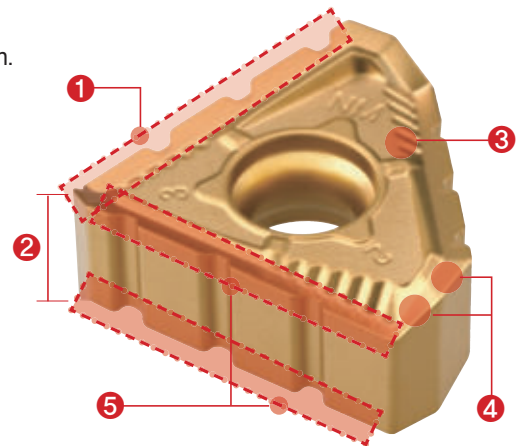
1 Major cutting-edge (Serrated edge)

- Low cutting force
- Ideal for chip control, divides chips into small pieces for proper chip evacuation.
- Ideal edge design for Steel and Cast iron rough milling

Comparison of chip control and cutting force

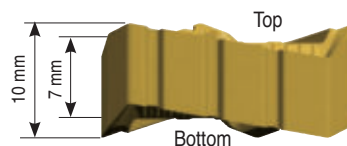


- **Workpiece** SCM440
- **Cutting condition** vc = 200 m/min, ap = 8 mm, ae = 90 mm, fz = 0.3 mm/t



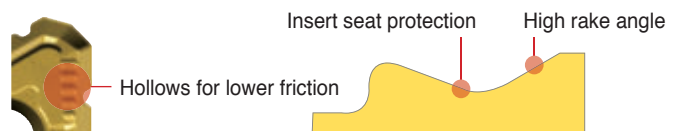
2 Thicker insert

- Thick insert guarantees high rigidity
- Balanced insert design for stable mounting



3 NM Chip breaker

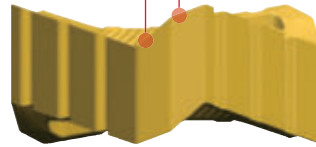
- High rake angle for low cutting force
- Good chip flow at various feed and depth of cut
- Inserts are protected with seats for a precise mounting
- Low friction and good heat evacuation at high depth cut



4 Insert shape applied to PBA/Z cutters (AA: 45°/80°)

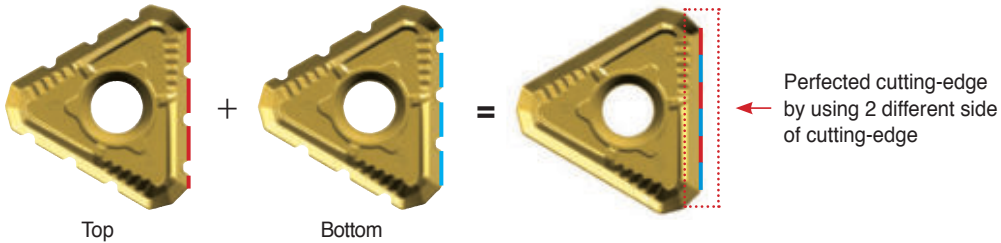
- High rake angle to avoid interference with chip
- Calculated minor cutting-edge angel for both AA 45° & 80° cutter

2nd minor cutting-edge for AA 80° 1st minor cutting-edge for AA 45°



5 Mirror system

- Cutting-edge on the both side of insert covers all overlapped cutting area



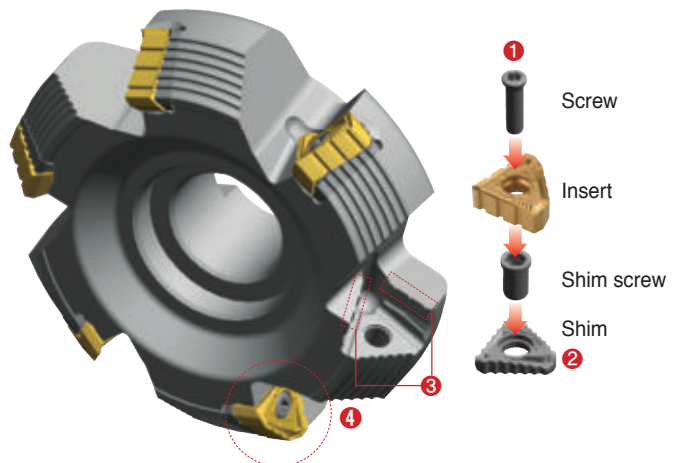
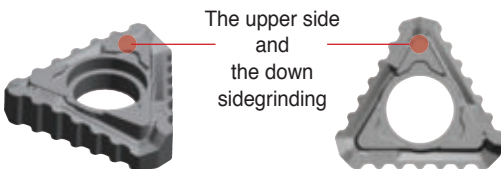
6 Features of cutter

1 Screw-on clamping system

- Simple and strong screw on clamping system

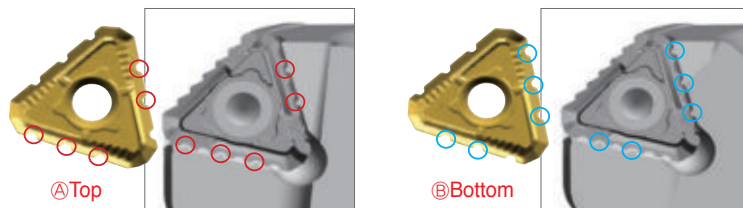
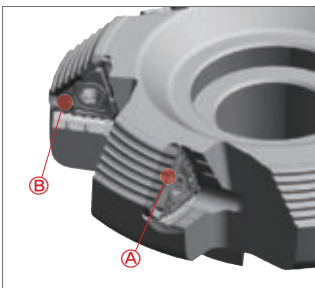
2 Better rigidity & Stable Assembly system

- The shim protects the cutter from insert damage
- High accuracy shim ensures tighter clamping



3 Foolproof System

- Insert serrations match pocket design to prevent improper seating and alignment

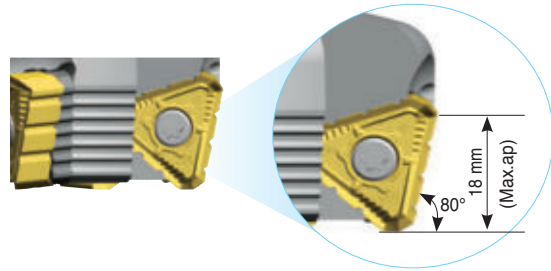
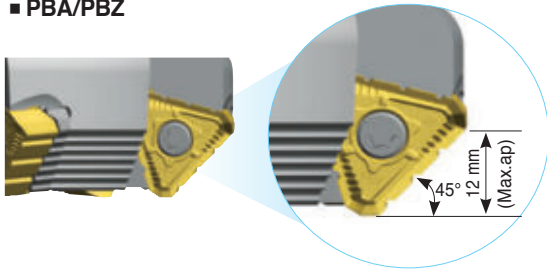


E Technical Information for Power Buster

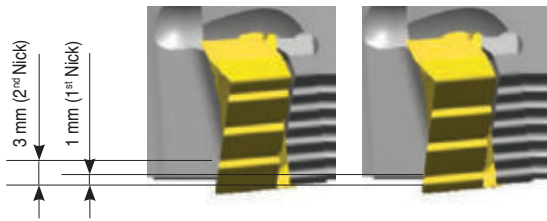
4 Multi-application system

- Same insert for multi-use (45° and 80°)

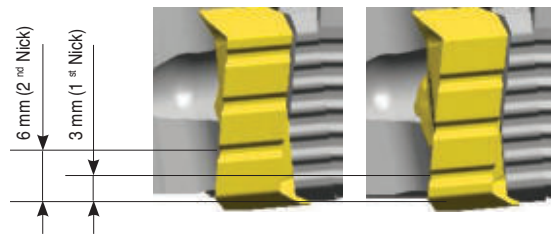
■ PBA/PBZ



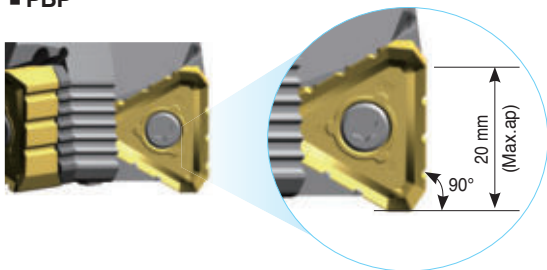
The serrations are effective with a depth of cut larger than 1 mm



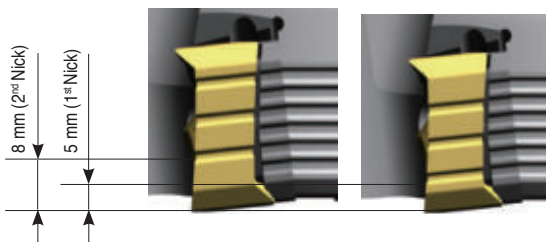
The serrations are effective with a depth of cut larger than 3 mm



■ PBP

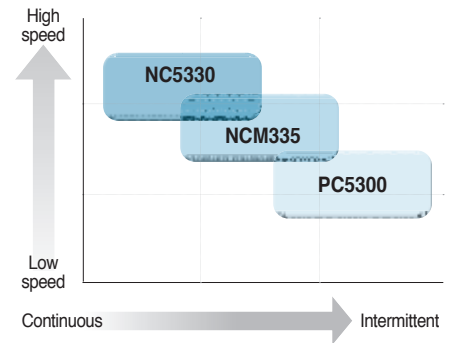


For the AA 90° cutter, nicks function properly at depth of cuts over 5 mm



Recommended cutting condition

ISO	Workpiece	Material	NC5330	NCM335	PC5300	
			fz (mm/t)			
			0.1-0.2-0.3	0.1-0.2-0.3	0.1-0.2-0.3	
			vc (m/min)			
P	Carbon steel	-	SUM22, C = 0.1~25	400	335	280
		-	C = 0.30~55	365	305	255
		-	C = 0.55~80	340	285	240
	Low alloy steel (Alloy constituent < 5%)	-	SCM415(H), SCM420, SCM440	280	235	195
		Hardened		165	140	115
		High alloy steel (Alloy constituent > 5%)	Annealed	SKD61	210	180
	Hardened	SKH51, SKH55	175	145	120	
K	Gray cast iron	Low tensile	FC200, FC250	125	-	145
		Hight tensile	FC300, FC350	105	-	120
		Ferric	FCD400, FCD500	80	-	95
		Pearlitic	FCD600, FCD700	75	-	85

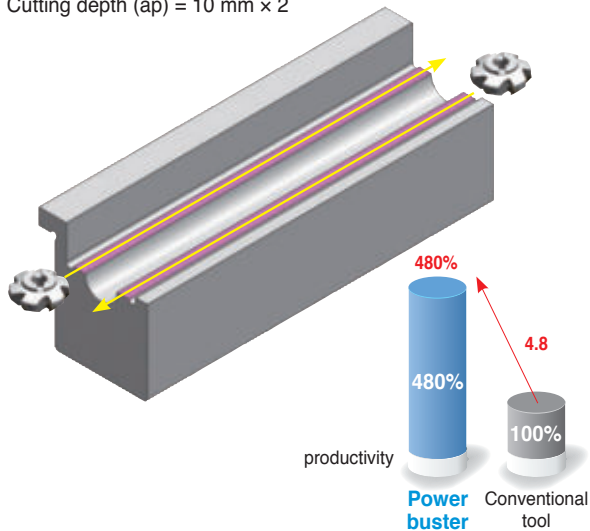


Power Buster test

■ Cylinder block for ship engine (Cast iron)

Cutting width (ae) = 160 mm x 2

Cutting depth (ap) = 10 mm x 2

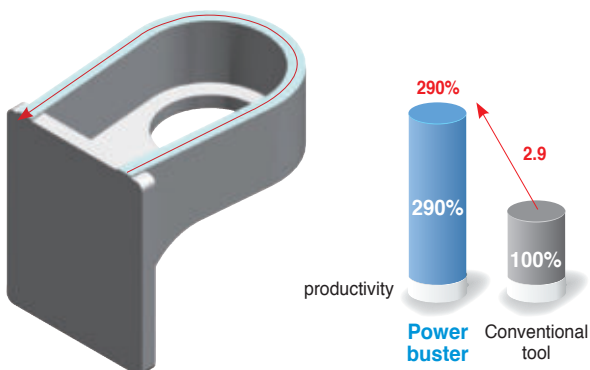


Item	Power buster	Conventional tool
Diameter (ØD)	200 mm	200 mm
	12 tooth	12 tooth
Grades	NC5330	PVD coating for Cast iron
vc	170 m/min	130 m/min
fz	0.24 mm/t	0.16 mm/t
ap	10 mm x 2 passes	4 mm x 5 passes
min	28.2 min/ea	137.5 min/ea
4.8 times productivity increased		<ul style="list-style-type: none"> • One-sided 4 corner insert (Without nick) • AA 45° cutter

■ Heavy machinery part (Alloy steel)

Cutting width (ae) = 35 mm

Cutting depth (ap) = 10 mm



Item	Power Buster	Conventional tool
Diameter (ØD)	125 mm	100 mm
	8 tooth	8 tooth
Grades	NCM335	PVD coating for Cast iron
vc	180 m/min	150 m/min
fz	0.15 mm/t	0.10 mm/t
ap	5 mm x 2 passes	2.5 mm x 4 passes
min	5 min/ea	14.7 min/ea
2.9 times productivity increased		<ul style="list-style-type: none"> • Double-sided 8 corner insert (Without nick) • AA 45° cutter

PBAC(M)5000

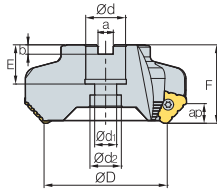


Fig. 1

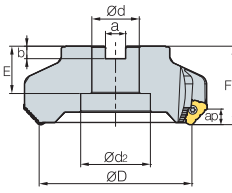


Fig. 2

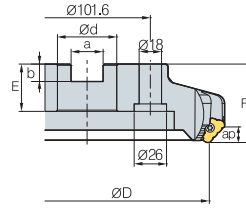


Fig. 3

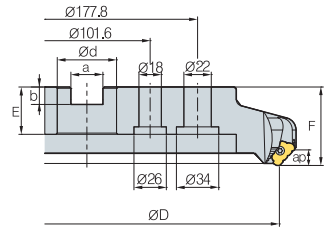


Fig. 4



AA
45°

• AR: -5°
• RR: -11°

(mm)

Designation		⊙	ØD	Ød	Ød1	Ød2	a	b	E	F	ap	Fig.
Coarse pitch	PBAC (PBACM) 5080R/L	4	80	25.4 (27)	14	20	9.5 (12.4)	6 (7)	25 (22)	50	12	1
	5100R/L	4	100	31.75 (32)	-	45	12.7 (14.4)	8 (8)	32 (28)	50	12	2
	5125R/L	6	125	38.1 (40)	-	56	15.9 (16.4)	10 (9)	38 (32)	63	12	2
	5160R/L	8	160	50.8 (40)	-	100	19 (16.4)	11 (9)	38 (32)	63	12	2
	5200R/L	10	200	47.625 (60)	-	-	25.4 (25.7)	14 (14)	38 (38)	63	12	3
	5250R/L	12	250	47.625 (60)	-	-	25.4 (25.7)	14 (14)	38 (38)	63	12	3
5315R/L	14	315	47.625 (60)	-	-	25.4 (25.7)	14 (14)	38 (38)	63	12	4	
Close pitch	PBAC (PBACM) 5080R/L-M	6	80	25.4 (27)	14	20	9.5 (12.4)	6 (7)	25 (22)	50	12	1
	5100R/L-M	6	100	31.75 (32)	-	45	12.7 (14.4)	8 (8)	32 (28)	50	12	2
	5125R/L-M	8	125	38.1 (40)	-	56	15.9 (16.4)	10 (9)	38 (32)	63	12	2
	5160R/L-M	10	160	50.8 (40)	-	100	19 (16.4)	11 (9)	38 (32)	63	12	2
	5200R/L-M	12	200	47.625 (60)	-	-	25.4 (25.7)	14 (14)	38 (38)	63	12	3
	5250R/L-M	14	250	47.625 (60)	-	-	25.4 (25.7)	14 (14)	38 (38)	63	12	3
5315R/L-M	16	315	47.625 (60)	-	-	25.4 (25.7)	14 (14)	38 (38)	63	12	4	

() Metric size

Available inserts

TNMX-NM



Designation	Cermet		Coated										Uncoated			page			
	CN2500	CN30	NC5330	NCM325	NCM335	NCM535	NCM545	PC2505	PC2010	PC3700	PC6510	PC9530	PC9540	PC5300	PC5400		ST30A	G10	H01
TNMX 2710AZNR-NM 2710AZNL-NM			●			●				●		●		●					E28

Available arbors

Designation	Available arbors	
	PBAC	PBACM
PBAC (PBACM) 5080R/L-□	BT□□-FMA25.4-□□	BT□□-FMC27-□□
5100R/L-□	BT□□-FMA31.75-□□	BT□□-FMC32-□□
5125R/L-□	BT□□-FMA38.1-□□	BT□□-FMB40-□□
5160R/L-□	BT□□-FMA50.8-□□	BT□□-FMC40-□□
5200R/L-□		
5250R/L-□	BT□□-FMA47.625-□□	BT□□-FMB60-□□
5315R/L-□		

Parts

Specification	 Screw	 Shim	 Shim screw	 Wrench
Ø80~Ø315	FTGA0518	ST53AZR	SHXN0712F	TW20-100

Available inserts E28 Available arbors and bolt E426-E428



PBZC(M)5000

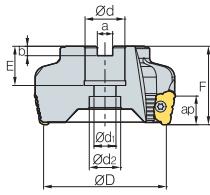
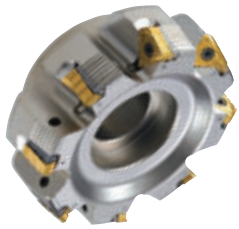


Fig. 1

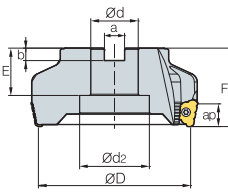


Fig. 2

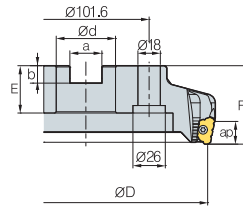


Fig. 3

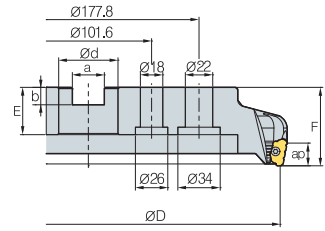


Fig. 4



AA
80°

• AR: -5°
• RR: -12°

(mm)

Designation		⊙	ØD	Ød	Ød ₁	Ød ₂	a	b	E	F	ap	Fig.
Coarse pitch	PBZC (PBZCM) 5080R/L	4	80	25.4 (27)	14	20	9.5 (12.4)	6 (7)	25 (22)	50	18	1
	5100R/L	4	100	31.75 (32)	-	45	12.7 (14.4)	8 (8)	32 (28)	50	18	2
	5125R/L	6	125	38.1 (40)	-	56	15.9 (16.4)	10 (9)	38 (32)	63	18	2
	5160R/L	8	160	50.8 (40)	-	100	19 (16.4)	11 (9)	38 (32)	63	18	2
	5200R/L	10	200	47.625 (60)	-	-	25.4 (25.7)	14 (14)	38 (38)	63	18	3
	5250R/L	12	250	47.625 (60)	-	-	25.4 (25.7)	14 (14)	38 (38)	63	18	3
	5315R/L	14	315	47.625 (60)	-	-	25.4 (25.7)	14 (14)	38 (38)	63	18	4
Close pitch	PBZC (PBZCM) 5080R/L-M	6	80	25.4 (27)	14	20	9.5 (12.4)	6 (7)	25 (22)	50	18	1
	5100R/L-M	6	100	31.75 (32)	-	45	12.7 (14.4)	8 (8)	32 (28)	50	18	2
	5125R/L-M	8	125	38.1 (40)	-	56	15.9 (16.4)	10 (9)	38 (32)	63	18	2
	5160R/L-M	10	160	50.8 (40)	-	100	19 (16.4)	11 (9)	38 (32)	63	18	2
	5200R/L-M	12	200	47.625 (60)	-	-	25.4 (25.7)	14 (14)	38 (38)	63	18	3
	5250R/L-M	14	250	47.625 (60)	-	-	25.4 (25.7)	14 (14)	38 (38)	63	18	3
	5315R/L-M	16	315	47.625 (60)	-	-	25.4 (25.7)	14 (14)	38 (38)	63	18	4

() Metric size

Available inserts

TNMX-NM



Designation	Cermet		Coated											Uncoated			page		
	CN2500	CN30	NC5330	NCM325	NCM335	NCM635	NCM645	PC2505	PC2010	PC3700	PC6510	PC9530	PC9540	PC5300	PC5400	ST30A		G10	H01
TNMX 2710AZNR-NM			●			●				●		●		●					E28
2710AZNL-NM																			E28

Available arbors

Designation	Available arbors	
	PBZC	PBZCM
PBZC (PBZCM) 5080R/L-□	BT□□-FMA25.4-□□	BT□□-FMC27-□□
5100R/L-□	BT□□-FMA31.75-□□	BT□□-FMC32-□□
5125R/L-□	BT□□-FMA38.1-□□	BT□□-FMB40-□□
5160R/L-□	BT□□-FMA50.8-□□	BT□□-FMC40-□□
5200R/L-□		
5250R/L-□	BT□□-FMA47.625-□□	BT□□-FMB60-□□
5315R/L-□		

Parts

Specification				
Ø80-Ø315	FTGA0518	ST53AZR	SHXN0712F	TW20-100

Available inserts E28 Available arbors and bolt E426-E428

PBPCM6000 new

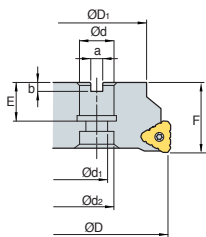


Fig. 1

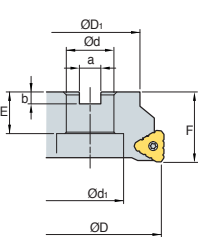


Fig. 2

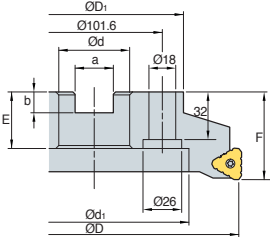


Fig. 3

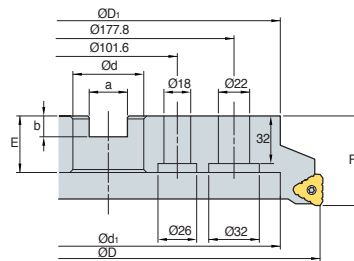


Fig. 4



AA
90°
• AR: -5°
• RR: -12°

(mm)

Designation		ØD	ØD1	Ød	Ød1	Ød2	a	b	E	F	ap		Fig.
PBPCM													
6080R-4	4	80	60	27	14	20	12.4	7	24	50	20	0.85	1
6100R-6	6	100	70	32	-	54	14.4	8	30	50	20	1.16	2
6125R-6	6	125	90	40	-	56	16.4	9	32	63	20	2.84	2
6160R-8	8	160	107	40	-	90	16.4	9	32	63	20	3.58	3
6200R-10	10	200	130	60	-	132	25.7	14	38	63	20	5.13	3
6250R-12	12	250	180	60	-	180	25.7	14	38	63	20	9.6	3
6315R-14	14	315	240	60	-	238	25.7	14	38	63	20	16.85	4

Available inserts

TNMX-NM



Designation	Cermet		Coated										Uncoated			page			
	CN2500	CN30	NC5330	NCM325	NCM335	NCM535	NCM545	PC2505	PC2010	PC3700	PC6510	PC9530	PC9540	PC5300	PC5400		ST30A	G10	H01
TNMX 3012PNR-NM																			E28

Available arbors

Designation	General arbor
PBPCM 6080R-4	BT□□-FMC27-□□
6100R-6	BT□□-FMC32-□□
6125R-6	
6160R-8	BT□□-FMC40-□□
6200R-10	
6250R-12	BT□□-FMC60-□□
6315R-14	

Parts

Specification				
Ø80~Ø315	FTGA0518	ST53PNR	SHXN0712F	TW20-100

Available inserts E28 Available arbors and bolt E426-E428



Rich Mill series is one of innovations that provides more available cutting-edges by double-sided insert and longer tool life for our customers

Rich Mill Series

- Rich Mill series is one of the innovations that provides more available cutting-edges with double-sided inserts and longer tool life for our customers
- The unique geometry and special cutting-edge guarantees low cutting loads and long tool life
- Rich Mill series has a wide application range from steel and stainless steel to cast iron and aluminum
- Applying negative inserts makes it even stronger and provides longer tool life
- Rich Mill series has both screw-on clamping system and latch clamping system

Code system

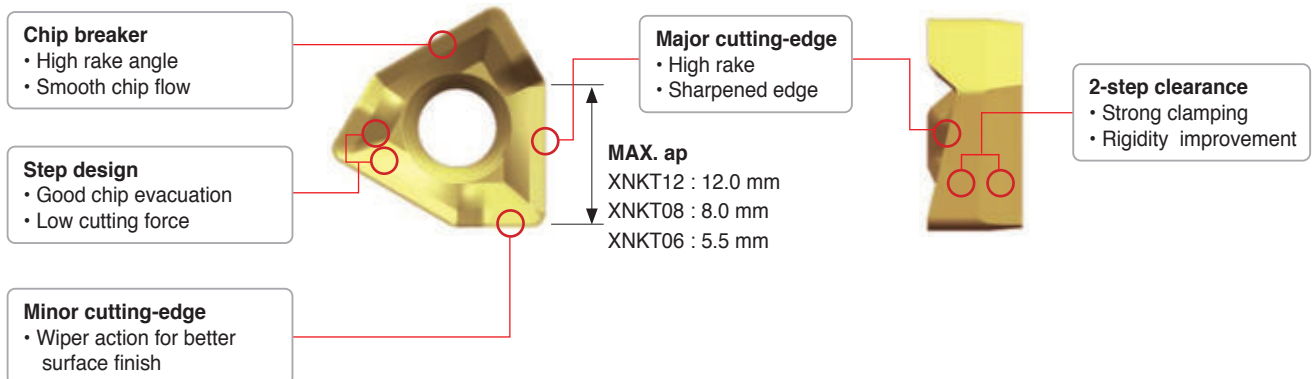
RM16	A	C	M	4	100	H	R - M	
Number of edges	Approach angle	Tool type	Arbors type	Inscribed circle of insert	Tool Dia.	Coolant type	Hand	Pitch type
RM3 : Number of edges-3 RM4 : Number of edges-4 RM6 : Number of edges-6 RM8 : Number of edges-8 RM8-X : Number of edges-8 (High helix) RM14 : Number of edges-14 RM16 : Number of edges-16 RMT8 : Number of edges-8 (Latch Clamp) RMH8 : Number of edges-8 (Shim) RMR : Number of edges-8 (Round Type)	A : 45° D : 30° E : 15° F : 5° P : 0° Q : 2° Z : Plunging	C : Cutter S : Shank	M : Metric A : Inch	3 : 9.525 4 : 12.7 5 : 15.875	Ø100	H : Thru-Hole No code : None	R : Right L : Left	M : Close H : Extra Close

Rich Mill RM3

Features

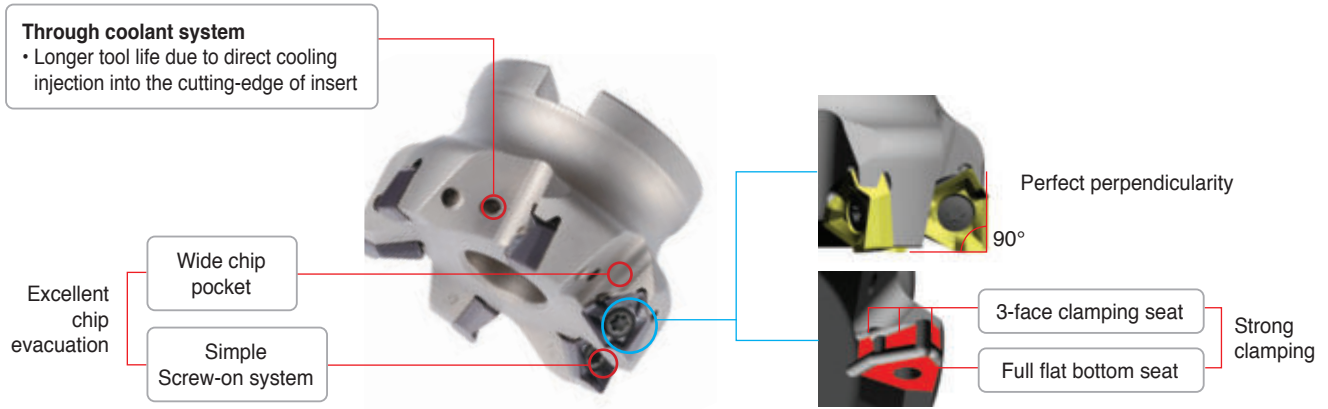
- High Quality - True 90° shouldering operation
- High Productivity - Strong thick insert and 3-face clamping ensure stable operation even tough condition.
- High Economics - Long tool life due to optimized manufacturing process

Features of insert



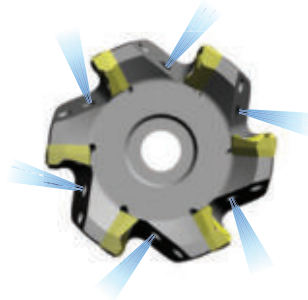
Rich Mill RM3

Features of cutter



Through coolant system

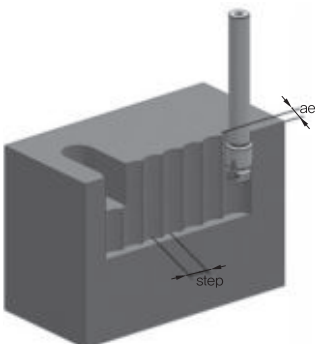
- Exclusive through coolant bolt required
- Effective coolant distribution directly to cutting-edge
- Coolant supporting arbor required



Features of chip breakers

Insert	Cutting-edge	Uses	Features
MA		Aluminum	Superior cutting quality for aluminum due to sharp cutting-edge and buffed surface
ML		Light	Superior cutting quality for light and light cutting, difficult-to-cut material machining through the low cutting load of chip breaker
MM		General	Suitable for various cutting due to special shape design for general cutting

Max step in plunging



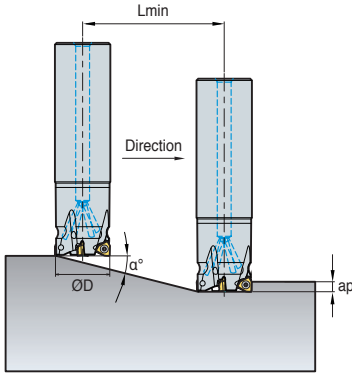
Type	max. ae	Cutter Diameter (Ø)												
		Ø20	Ø21	Ø25	Ø26	Ø32	Ø33	Ø40	Ø50	Ø63	Ø80	Ø100	Ø125	
3000 type	2.5	max step (mm)												
4000 type	3.0	1	8.5	8.9	9.7	10	11.1	11.3	12.4	14	15.7	17.7	19.9	22.2
5000 type	3.5	2	12	12.3	13.5	13.8	15.4	15.7	17.4	19.5	22	24.9	28	31.3
		3	-	-	-	-	-	-	21	23.7	26.8	30.3	34.1	38.2



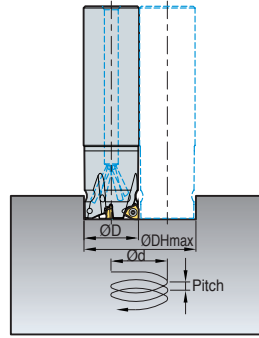
Rich Mill RM3

Ramping and helical cutting

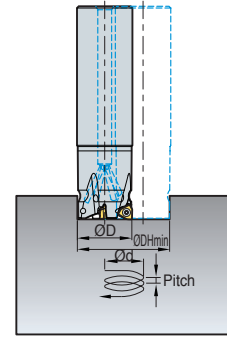
1. Ramping



2. Helical cutting for blind hole



3. Helical cutting for through hole



(mm)

Type	Tool Dia. ØD	ap	1. Ramping		2. Helical cutting for blind hole				3. Helical cutting for through hole	
			Max. rake angle α°	Lmin	Min. machining Dia. ØDHmin	Max. pitch	Max. machining Dia. ØDHmax	Max. pitch	Min. machining Dia. ØDHmin	Max. pitch
3000 type	20	5.5	15.5	19.8	36.5	5.5	38.5	5.5	33.0	5.5
	21	5.5	14.0	22.1	38.5	5.5	40.5	5.5	35.0	5.5
	25	5.5	10.0	31.2	46.5	5.5	48.5	5.5	43.0	5.5
	26	5.5	9.5	32.9	48.34	5.5	51.0	5.5	45.0	5.5
	32	5.5	6.5	48.3	60.5	5.5	62.5	5.5	59.0	5.5
	33	5.5	6.0	52.3	62.5	5.5	64.5	5.5	59.0	5.5
	40	5.5	4.5	69.9	46.5	5.5	78.5	5.5	73.0	5.5
	50	5.5	3.5	89.9	96.5	5.5	98.5	5.5	93.0	5.5
	63	5.5	2.5	126.0	122.5	5.5	124.5	5.5	119.0	5.5
	80	8	2.0	157.5	156.5	5.5	158.5	5.5	153.0	5.5
	100	8	1.5	210.0	194.5	5.5	198.5	5.5	193.0	5.5
125	8	1.0	315.1	246.5	5.5	248.5	5.5	243.0	5.5	
4000 type	25	8	24.0	18.0	44.5	8.0	48.0	8.0	38.5	8.0
	32	8	13.0	34.7	58.5	8.0	62.0	8.0	52.5	8.0
	33	8	12.0	37.6	60.02	8.0	64.4	8.0	54.5	8.0
	40	8	8.5	53.5	74.5	8.0	78.0	8.0	68.5	8.0
	50	8	6.0	76.1	94.5	8.0	98.0	8.0	88.5	8.0
	63	8	4.0	114.4	120.5	8.0	124.0	8.0	114.5	8.0
	80	8	3.0	152.6	154.5	8.0	158.0	8.0	148.5	8.0
	100	8	2.0	229.1	194.5	8.0	198.0	8.0	188.5	8.0
	125	8	1.5	305.5	244.5	7.7	248.0	7.8	238.5	7.7
5000 type	80	12	5.5	124.6	153.5	12.0	158.0	12.0	146.5	12.0
	100	12	4.5	152.5	193.5	12.0	198.0	12.0	159.5	12.0
	125	12	3.5	196.2	242.5	12.0	248.0	12.0	236.5	12.0

* Please be sure to use cutting oil or air for ramping and helical machining
 $Lmin = ap / \tan(\alpha^\circ)$

Rich Mill RM3

Application guideline for grade

Workpiece		P	M	K	N	
		Carbon steel	Alloy steel	Stainless steel	Cast iron	Aluminum
Chip breaker	First choice	MM	MM	ML	ML	MA
	Second choice	ML	ML	-	MM	-
Grades	High speed machining	PC3700	PC3700	PC5300	PC6510	H01
	General machining	PC5400	PC5300	PC5400	PC5300	
	Interrupted machining	PC5400	PC5400	PC5400	PC5400	

Recommended cutting condition

• RM3 3000 type

Workpiece	Grades	Cutting conditions				Cutting conditions				
		vc (m/min)	fz (mm/t)	max ap (mm)	Available inserts	vc (m/min)	fz (mm/t)	max ap (mm)	Available inserts	
P	steel	PC3700	160~270	0.25~0.05	5.5	XNKT0604□□ PNSR-MM	160~270	0.2~0.05	5.5	XNKT0604□□ PNER-ML
		PC5300	150~240	0.25~0.05			150~240	0.25~0.05		
		PC5400	130~210	0.25~0.05			130~210	0.25~0.05		
M	Stainless steel	PC5300	90~150	0.2~0.05			90~150	0.1~0.05		
		PC5400	70~120	0.2~0.05			70~120	0.1~0.05		
K	Cast iron	PC6510	140~230	0.3~0.08			140~230	0.25~0.08		
		PC5300	120~200	0.3~0.08			120~200	0.25~0.08		

* Maximum cutting condition: vc = 350 m/min, fz = 0.5 mm/t according to cutting environment

• RM3 4000 type

Workpiece	Grades	Cutting conditions				Cutting conditions							
		vc (m/min)	fz (mm/t)	max ap (mm)	Available inserts	vc (m/min)	fz (mm/t)	max ap (mm)	Available inserts				
P	steel	PC3700	160~270	0.3~0.05	8.0	XNKT0805□□ PNSR-MM	160~270	0.25~0.05	8.0	XNKT0805□□ PNER-ML			
		PC5300	150~240	0.3~0.05			150~240	0.25~0.05					
		PC5400	130~210	0.3~0.05			130~210	0.25~0.05					
M	Stainless steel	PC5300	90~150	0.25~0.05			90~150	0.2~0.05					
		PC5400	70~120	0.25~0.05			70~120	0.2~0.05					
K	Cast iron	PC6510	140~230	0.35~0.08			140~230	0.3~0.08					
		PC5300	120~200	0.35~0.08			120~200	0.3~0.08					
N	Aluminum	H01	400~1200	0.4~0.1			XNCT0805□□PNFR-MA	-			-	-	-

* Maximum cutting condition: vc = 350 m/min, fz = 0.5 mm/t according to cutting environment

• RM3 5000 type

Workpiece	Grades	Cutting conditions				Cutting conditions							
		vc (m/min)	fz (mm/t)	max ap (mm)	Available inserts	vc (m/min)	fz (mm/t)	max ap (mm)	Available inserts				
P	steel	PC3700	160~270	0.3~0.05	12.0	XNKT1206□□ PNSR-MM	160~270	0.25~0.05	12.0	XNKT1206□□ PNER-ML			
		PC5300	150~240	0.3~0.05			150~240	0.25~0.05					
		PC5400	130~210	0.3~0.05			130~210	0.25~0.05					
M	Stainless steel	PC5300	90~150	0.25~0.05			90~150	0.2~0.05					
		PC5400	70~120	0.25~0.05			70~120	0.2~0.05					
K	Cast iron	PC6510	140~230	0.35~0.08			140~230	0.3~0.08					
		PC5300	120~200	0.35~0.08			120~200	0.3~0.08					
N	Aluminum	H01	400~1200	0.4~0.1			XNCT1206□□PNFR-MA	-			-	-	-

* Maximum cutting condition: vc = 350 m/min, fz = 0.5 mm/t according to cutting environment



Rich Mill RM4

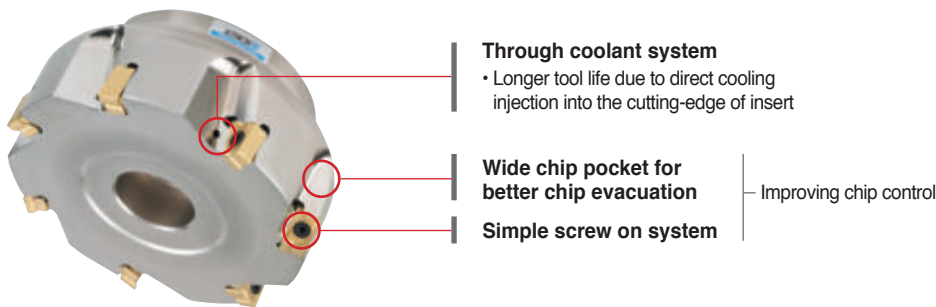
Features

- Economical 4 cutting-edges by using double-sided insert
- RM4, as a multi-functional milling tool, offers economical 4 cutting-edges by using an innovative double-sided insert
- Special designed chip breaker consists of high rake angle and strong cutting-edge to decrease the cutting load
- RM4 is multi-functional tool that can cover facing, side cutting, shouldering, slotting, ramping & helical cutting
- Optimal matching of the special cutting-edge geometry with variety of new grades provides consistence & long tool life of insert



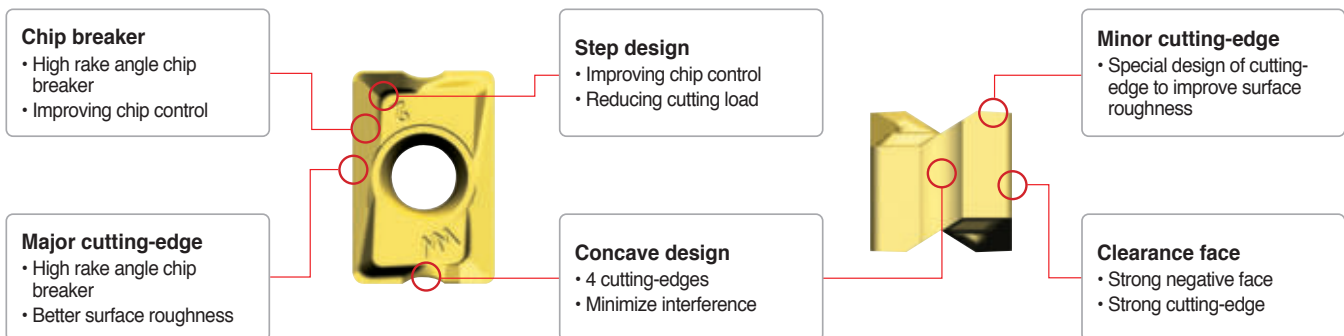
Features of cutter

- 4 cutting - edges can be used by using double-sided insert
- High rake angle chip breaker and cutting-edge can make smooth cutting with low cutting load
- Strong negative insert
- High efficiency, economical, multi-functional tool

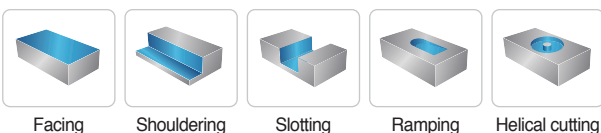


Features of insert

- Double-sided insert using 4 cutting-edges
- High rake angle chip breaker, cutting-edge
- Flexibility of product
- High efficiency, economical, multi-functional tool
- Negative insert has strong cutting-edge



Uses



Facing

Shouldering







Slotting

Ramping


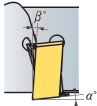
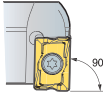
Helical cutting

Rich Mill RM4

Features of chip breakers

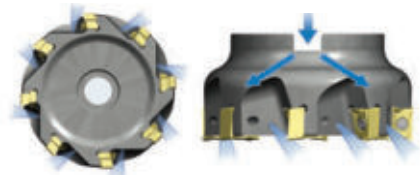
Insert	Cutting-edge	Uses	Features
MA 		Aluminum, Light machining	With sharp edge application the better productivity has been accomplished, especially for Aluminum or low force cut
MF 		Light cutting	Due to low cutting load, it is good for light cutting and difficult-to-cut material
MM 		General cutting	It is suitable design for general milling

Setting configuration

Shape	Setting angle of insert	Features
	 β° α°	High rake chip breaker & positive setting angle for low cutting load → Improving machinability
	 90°	Multi applications for facing, shouldering, slotting, ramping, helical cutting, etc

Through coolant system

- By using on exclusive coolant bolt (hexagonal socket bolt) powerful cooling & better chip evacuation can be acquired
- To get optimal chip control, the direction of coolant injection has been designed to reach to each cutting-edge directly (through coolant arbor is required)

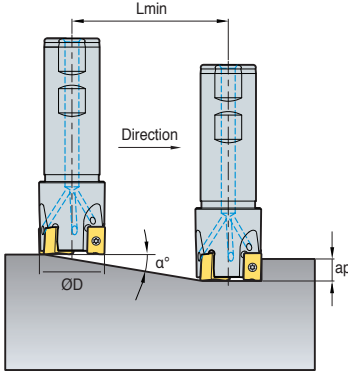


Through coolant system for decreasing cutting heat and good chip evacuation

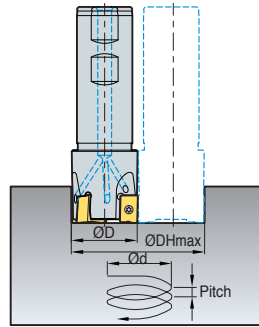
Rich Mill RM4

Ramping and helical cutting

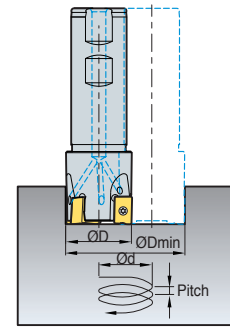
1. Ramping



2. Helical cutting for blind hole



3. Helical cutting for through hole



(mm)

Designation	Tool Dia. ØD	ap	1. Ramping		2. Helical cutting for blind hole			3. Helical cutting for through hole		
			Max. rake angle α°	Lmin	Min. machining Dia. ØDHmin	Max. pitch	Max. machining Dia. ØDHmax	Max. pitch	Min. machining Dia. ØDHmin	Max. pitch
RM4PS3014HR	14	9	4.5	125	25	2.7	27	3.1	19	1.3
RM4PS3016HR	16	9	3.5	160	29	2.5	31	2.7	23	1.4
RM4PS3018HR	18	9	3.0	185	33	2.4	35	2.7	27	1.5
RM4PS3020HR	20	9	2.7	204	37	2.5	39	2.7	31	1.6
RM4PS3025HR	25	9	1.8	301	47	2.1	49	2.3	41	1.6
RM4PS3032HR	32	9	1.2	451	61	1.9	63	2.0	55	1.5
RM4PS3040HR	40	9	0.9	616	77	1.8	79	1.8	71	1.5
RM4PS3050HR	50	9	0.6	843	97	1.5	99	1.5	91	1.3
RM4PC(M)3040HR	40	9	0.9	616	77	1.8	79	1.8	71	1.5
RM4PC(M)3050HR	50	9	0.6	843	97	1.5	99	1.5	91	1.3
RM4PC(M)3063HR	63	9	0.5	1123	123	1.6	125	1.6	117	1.4
RM4PC(M)3080HR	80	9	0.3	1508	157	1.2	159	1.2	151	1.1
RM4PC(M)3100HR	100	9	0.2	1910	197	1.0	199	1.0	191	0.9
RM4PS4032HR	32	14	2.5	229	59.5	3.0	62	4	49	2.0
RM4PS4040HR	40	14	2.0	286	75.5	3.0	78	4	65	2.0
RM4PS4050HR	50	14	2.0	286	95.5	4.0	98	5	85	3.5
RM4PS4063HR	63	14	2.0	286	121.5	5.0	124	5	111	5.0
RM4PC(M)4050HR	50	14	2.0	286	95.5	4.0	98	5	85	3.5
RM4PC(M)4063HR	63	14	2.0	286	121.5	5.0	124	5	111	5.0
RM4PC(M)4080HR	80	14	1.5	382	155.5	5.0	158	5	145	5.0
RM4PC(M)4100HR	100	14	1.0	573	195.5	4.5	198	5	185	4.0
RM4PC(M)4125HR	125	14	1.0	573	245.5	5.0	248	5	235	5.0
RM4PC(M)4160R	160	14	0.5	1146	315.5	3.5	318	4	305	3.5

* Please be sure to use cutting oil or air for ramping and helical machining
 $Lmin = ap / \tan(\alpha^\circ)$

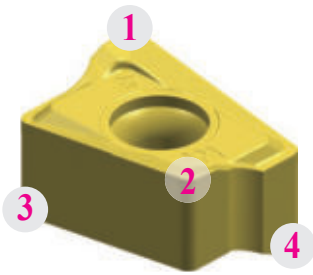
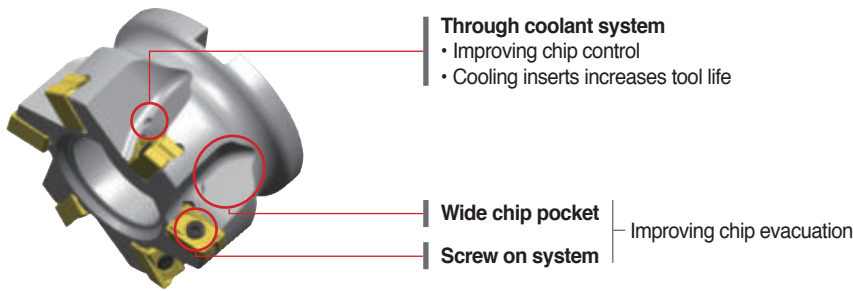
Recommended cutting condition

ISO	Grades	LNM(E)X100605PNR-MF		LNM(E)X100605PNR-MM		LNEX100605PNR-MA		Max-ap (mm)	LNM(E)X151008PNR-MF		LNM(E)X151008PNR-MM		LNEX151008PNR-MA		Max-ap (mm)
		vc (m/min)	fz (mm/t)	vc (m/min)	fz (mm/t)	vc (m/min)	fz (mm/t)		vc (m/min)	fz (mm/t)	vc (m/min)	fz (mm/t)	vc (m/min)	fz (mm/t)	
P	NCM535	-	-	-	-	-	-	9.0	150~300	0.05~0.30	120~300	0.05~0.35	150~300	0.03~0.20	14.0
	PC3700	150~300	0.05~0.25	120~300	0.05~0.30	150~300	0.03~0.20		150~300	0.05~0.30	120~300	0.05~0.35	150~300	0.03~0.20	
M	PC5300	120~180	0.05~0.25	100~180	0.05~0.30	120~200	0.03~0.20		120~180	0.05~0.30	100~180	0.05~0.3	120~200	0.03~0.20	
K	PC6510	150~300	0.08~0.30	120~300	0.08~0.35	-	-		150~300	0.08~0.35	120~300	0.08~0.35	-	-	

Rich Mill RM4Z

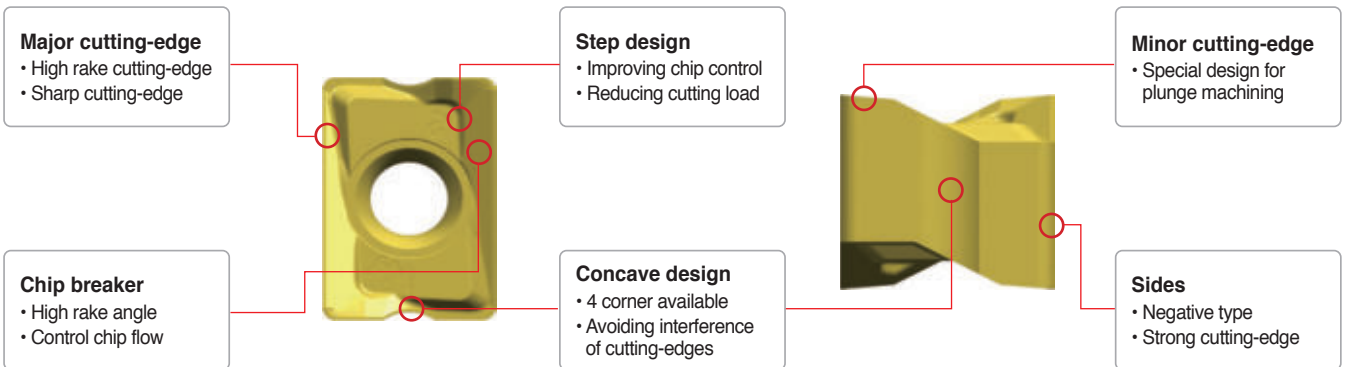
Features

- Rich mill series RM4Z is a plunge mill for high efficiency vertical machining such as slotting and pocketing in roughing applications
- Rich mill series RM4Z is a highly efficient milling tool for plunging, shouldering and facing. It makes operations more economical with the use of its double-sided 4-corner insert
- Plunge machining reduces lead time for high productivity and precision machining.
- In plunging the max depth of RM4Z 3000 type is 9.0 mm and that of RM4Z 4000 type is 14.0 mm

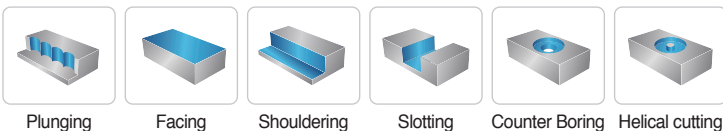


- Double-sided insert ... 4 corner available
- High rake angle chip breaker and cutting-edge
- Various available machining types
- High efficiency and economical insert
- Negative type insert - Strong cutting-edge

Features of insert



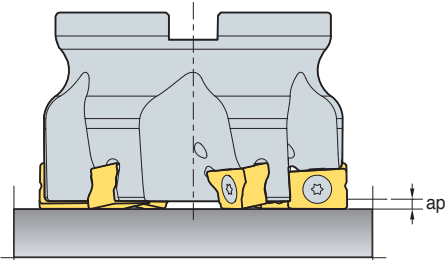
Uses



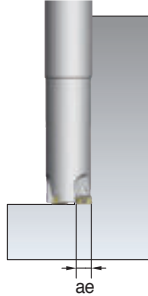
Rich Mill RM4Z

➤ The depth of cut by machining type

• In horizontal machining, Depth of cut = a_p (mm)

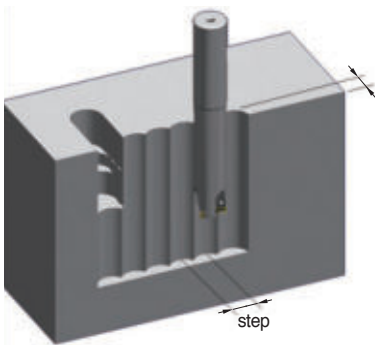


• In plunging, Depth of cut = a_e (mm)



RM4Z	Horizontality	Verticality	
	max a_p (mm)	max a_e (mm)	step
RM4Z3000	1.5	9	< 0.7D
RM4Z4000	2.5	14	< 0.7D

➤ Max step in plunging

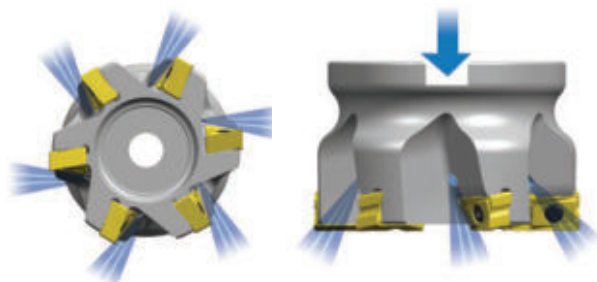


ae	Cutter Diameter (mm)								
	25	32	40	50	52	63	66	80	100
	Max step (mm)								
1	9.7	11.1	12.4	14	14.2	15.7	16.1	17.7	19.9
2	13.5	15.4	17.4	19.5	20	22	22.6	24.9	28
3	16.2	18.6	21	23.7	24.2	26.8	27.4	30.3	34.1
4	18.3	21.1	24	27.1	27.7	30.7	31.4	34.8	39.1
5	20	23.2	26.4	30	30.6	34	34.9	38.7	43.5
6	21.3	24.9	28.5	32.4	33.2	36.9	37.9	42.1	47.4
7	22.4	26.4	30.3	34.6	35.4	39.5	40.6	45.2	51
8	23.3	27.7	32	36.6	37.5	41.9	43	48	54.2
9	24	28.7	33.4	38.4	39.3	44	45.2	50.5	57.2
10	-	-	-	-	-	46	47.3	52.9	60
11	-	-	-	-	-	47.8	49.1	55.1	62.5
12	-	-	-	-	-	49.4	50.9	57.1	64.9
13	-	-	-	-	-	50.9	52.4	59	67.2
14	-	-	-	-	-	52.3	53.9	60.7	69.3

➤ Through coolant system

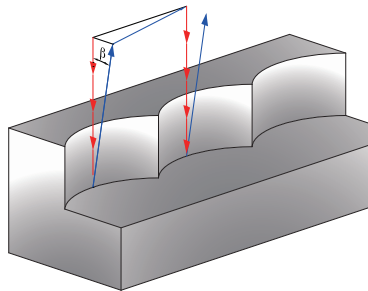
- Exclusive hexagonal coolant socket bolt provides excellent cooling and chip evacuation
- Direct coolant injection to cutting-edge improves cooling effectiveness
- Coolant type arbor should be used

*Coolant bolt is not included, it is for sale



Rich Mill RM4Z

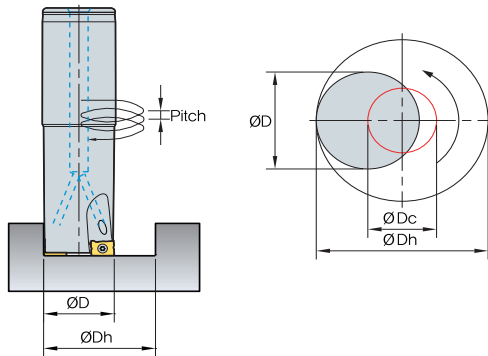
Programming tip



- - - Plunging feed direction
- Tool escape
- β Escape angle ($\beta \geq 1^\circ$)

• When your tool steps back after plunging, please get over 1° more escape angle

Helical machining



$$\text{ODc} = \text{ODh} - \text{OD}$$

ODc = Tool center path
 ODh = Desired hole diameter
 OD = Tool Dia.

(mm)

Designation	Diameter OD (mm)	Helical data				
		Min. machining Dia. ODHmin	Max. pitch	Max. machining Dia. ODHmax	Max. pitch	
RM4ZS	3025HR-L25	25	30	0.4	48	1.8
	3032HR-L32	32	43	0.3	62	0.9
	3040HR-L32	40	59	0.3	78	0.6
RM4ZCM	3040HR	40	59	0.3	78	0.6
	3050HR	50	79	0.3	98	0.5
	3052HR	52	83	0.3	102	0.5
RM4ZM	3025HR-M12	25	30	0.4	48	1.8
	3032HR-M16	32	43	0.3	62	0.9
	3040HR-M16	40	59	0.3	78	0.6
RM4ZCM	4063HR	63	95	0.5	124	1.0
	4066HR	66	101	0.5	130	1.0
	4080HR	80	129	0.5	158	0.8
	4100HR	100	169	0.3	198	0.5

Recommended cutting condition

ISO	Grades	LNM(E)X100605PNL-MM				LNM(E)X151008PNL-MM			
		vc (m/min)	fz (mm/t)	* max ae (mm)	** max ap (mm)	vc (m/min)	fz (mm/t)	* max ae (mm)	** max ap (mm)
P	PC3700	100~250	0.05~0.25	9	1.5	120~250	0.05~0.25	14	2.5
M	PC5300	100~250	0.08~0.30			120~250	0.08~0.30		
K	PC6510	80~180	0.05~0.20			100~180	0.05~0.20		

* max ae (mm): (Plunging) max. radial depth of cut

** max ap (mm): (Shouldering/Facing) max depth of cut



Rich Mill RM6

Features

- Stable clamping - 3 clamping surfaces on the side and strong clamping screws
→ Improves cutting stability
- High quality results - High precision, excellent perpendicularity, outstanding surface finish on the flank, accurate tolerance
- High productivity - High rake angle and sharp cutting-edges for lower cutting resistance
→ Ideal for high speed and high feed machining

Features of insert

Higher clamping stability

- Wide clamping areas and strong clamping screws for rigid clamping

High rake angle chip breaker

- Maintains stable clamping
- Induces smooth chip flow
→ Increases insert life

Wide minor cutting-edges

- Improved surface finish
- Enable multi-purpose machining incl. plunging

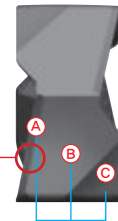
High rake cutting-edges

- Improved machinability and reduces cutting resistance

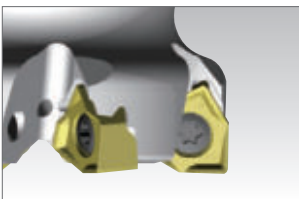
MAX. ap
WNGX08: 8.2 mm
WNGX04: 4.3 mm

3-level flank relief surface

- Enhances rigidity and enables stable clamping
→ Improves cutting stability

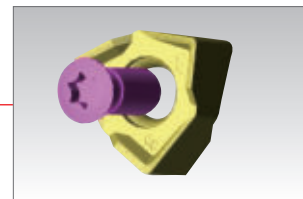


Features of cutter



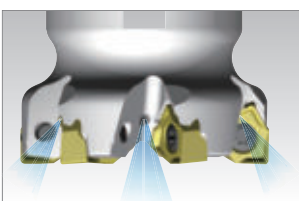
Streamlined holder design

- Improved chip evacuation in deep shouldering and slotting



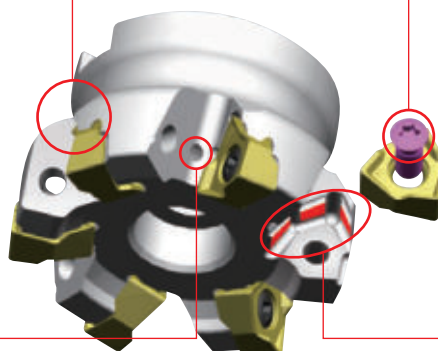
Strong clamping screws

- Strong clamping screws enable rigid clamping



Through coolant system

- Improved chip flow and tool life thanks to insert cooling









3-side supporting system

- Stable tool life

Rich Mill RM6

Features of chip breakers

Insert	Cutting-edge	Uses	Features
MA			For aluminum Sharp cutting-edges for excellent cutting performance in aluminum machining Buffed surface for excellent chip flow and welding resistance
ML			For light cutting Chip breaker design of low cutting resistance, ideal for light cutting and machining hard-to-cut materials Excellent tool life and quality results
MM			For general cutting Chip breaker design ideal for general shoulder milling and most applications

Application guideline for grade

Workpiece		P	M	K	N	
		Carbon steel	Alloy steel	Stainless steel	Cast iron	Non-ferrous metal
Shape	1st recommended	MM	MM	ML	ML	MA
	2nd recommended	ML	ML	-	MM	MA
Grades	High speed milling	PC3700	PC3700	PC5300	PC6510	H01
	General milling	PC5400	PC5300	PC5400	PC5300	H01
	Interrupted milling	PC5400	PC5400	PC5400	PC5400	H01

Recommended cutting condition

• WNGX04

Workpiece	Grades	WNGX040304PNSR-MM			WNGX040304PNER-ML			WNGX040304PNFR-MA		
		vc (m/min)	fz (mm/t)	max. ap(mm)	vc (m/min)	fz (mm/t)	max. ap(mm)	vc (m/min)	fz (mm/t)	max. ap(mm)
P Steel	PC3700	160~270	0.25~0.05	4.3	160~270	0.20~0.05	4.3	-	-	4.3
	PC5300	150~240	0.25~0.05		150~240	0.25~0.05		-	-	
	PC5400	130~210	0.25~0.05		130~210	0.25~0.05		-	-	
M Stainless steel	PC5300	90~150	0.20~0.05		90~150	0.10~0.05		-	-	
	PC5400	70~120	0.20~0.05		70~120	0.10~0.05		-	-	
K Cast iron	PC6510	140~230	0.30~0.08		140~230	0.25~0.08		-	-	
	PC5300	120~200	0.30~0.08	120~200	0.25~0.08	-	-			
N Non-ferrous metal	H01	-	-	-	-	-	500~1000	0.2~0.05	4.3	

※ The above data refer to general cutting conditions and can be adjustable up to 300 m/min and 0.4 mm/t depending on user environment.

• WNGX08

Workpiece	Grades	WNGX080608PNSR-MM			WNGX080608PNER-ML			WNGX080608PNFR-MA		
		vc (m/min)	fz (mm/t)	max. ap(mm)	vc (m/min)	fz (mm/t)	max. ap(mm)	vc (m/min)	fz (mm/t)	max. ap(mm)
P Steel	PC3700	160~270	0.25~0.05	8.2	160~270	0.20~0.05	8.2	-	-	8.2
	PC5300	150~240	0.25~0.05		150~240	0.25~0.05		-	-	
	PC5400	130~210	0.25~0.05		130~210	0.25~0.05		-	-	
M Stainless steel	PC5300	90~150	0.20~0.05		90~150	0.10~0.05		-	-	
	PC5400	70~120	0.20~0.05		70~120	0.10~0.05		-	-	
K Cast iron	PC6510	140~230	0.30~0.08		140~230	0.25~0.08		-	-	
	PC5300	120~200	0.30~0.08	120~200	0.25~0.08	-	-			
N Non-ferrous metal	H01	-	-	-	-	-	500~1000	0.2~0.05	8.2	

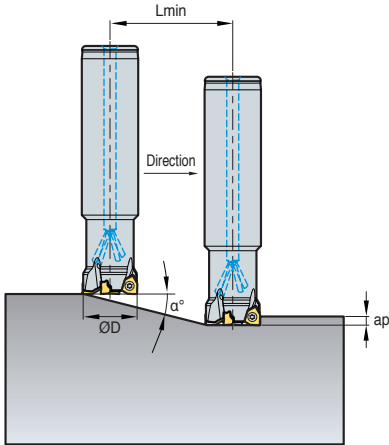
※ The above data refer to general cutting conditions and can be adjustable up to 300 m/min and 0.4 mm/t depending on user environment.



Rich Mill RM6

Ramping

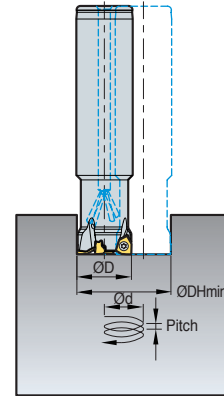
1. Ramping



2. Helical cutting for blind holes



3. Helical cutting for through holes



(mm)

Designation	Tool Dia. ØD	ap	1. Ramping		2. Helical cutting for blind holes				3. Helical cutting for through holes		
			Max. rake angle α°	Lmin	Min. machining Dia. ØDHmin	Max. pitch	Max. machining Dia. ØDHmax	Max. pitch	Min. machining Dia. ØDHmin	Max. pitch	
RM6PS	032R-2W32-120-WN08	32	8	0.8	572.9	54	0.96	62	1.3	38.5	0.5
	040R-3W32-120-WN08	40	8	0.5	916.7	70	0.82	78	1.0	54.5	0.4
	050R-4W32-120-WN08	50	8	0.3	1527.9	90	0.66	98	0.8	74.5	0.3
RM6PCM	063R-22-6-WN08	63	8	0.2	2291.3	116	0.58	124	0.6	100.5	0.3
	080R-27-7-WN08	80	8	0.1	4583.7	150	0.38	158	0.4	134.5	0.2
	100R-32-8-WN08	100	8	0.1	4583.7	190	0.49	198	0.5	174.5	0.3
	125R-40-11-WN08	125	8	0.1	4583.7	240	0.63	248	0.6	224.5	0.3

$L_{min} = ap / \tan(\alpha^\circ)$

Lmin: Cutting length at min. rake angle
 ap: Axial depth of cut
 α°: Available rake angle for ramping

Rich Mill RM8

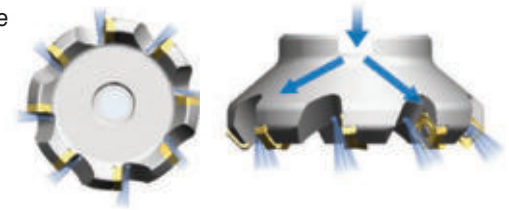
Features

- Double-sided insert to use 8 cutting-edges
- Innovative double-sided insert makes it possible to use 8 cutting-edges
It is more economical than conventional single sided insert
- The unique geometry and high rake angle of cutting-edge guarantees excellent surface finish
Applicable for various workpieces like steel, stainless steel, cast iron, aluminum
- Combined with the innovative geometry and various grades provided the tool offers durability and excellent tool life
- Various pitches and chip breakers can be applicable for diverse machining
- Light Rich Mill cutter can be useful for high speed machining and low power machine



Through coolant system

- Exclusive coolant bolt is adapted to get better chip evacuation and more powerful cooling. To get optimal chip evacuation, the direction of coolant injection has been designed to reach to each cutting-edge directly. Through coolant arbor is required



Through coolant system for decreasing cutting heat and good chip evacuation

Features of chip breakers

Insert	Cutting-edge	Uses	Features
MA		For aluminum	Due to sharp cutting-edge and buffed surface, it has good chip flow and welding resistance
ML		For hard-to-cut material	Chip breaker with low cutting load is optimal for machining hard-to-cut materials
MF		For light cutting	Due to low cutting load, it is good for light cutting and difficult-to-cut material
MM		For general cutting	It is suitable design for general milling
W		For wiper	Specialized edge design can be suitable for excellent surface roughness operation

Uses




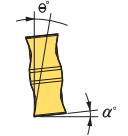
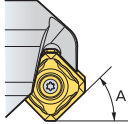
Facing

Features of insert

Insert	Cutting-edge	Features
	View-A 	High rake chip breaker & positive setting angle for low cutting load
	View-B 	Designed wiper technology in minor cutting-edge for improved surface roughness
	Chip breaker 	Low cutting load due to the positive setting and high rake angle chip breaker

Rich Mill RM8

Features of cutter

Shape	Setting angle of insert	Features
		High rake angle makes positive setting angle for low cutting load
		Suitable for facing and chamfering • RM8A A = 45° • RM8E A = 75° • RM8Q A = 88°

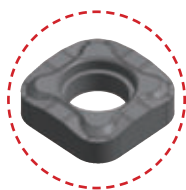
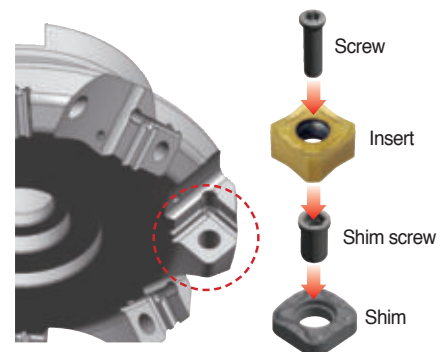
Recommended cutting condition

ISO	Grades	SNM(E)X1206A(E)NN-MF		SNM(E)X1206A(E)NN-MM		SNEX1206A(E)NN-MA		Max-ap (mm)	SNM(E)X1507A(E)NN-MF		SNM(E)X1507A(E)NN-MM		Max-ap (mm)
		vc (m/min)	fz (mm/t)	vc (m/min)	fz (mm/t)	vc (m/min)	fz (mm/t)		vc (m/min)	fz (mm/t)	vc (m/min)	fz (mm/t)	
P	NC5330	-	-	150~300	0.10~0.35	150~300	0.10~0.35	RM8A 6.0	-	-	150~300	0.10~0.35	RM8A 7.5
	NCM535	200~300	0.05~0.30	150~300	0.10~0.35	150~300	0.10~0.35		200~300	0.05~0.30	150~300	0.10~0.35	
	PC3700	200~300	0.05~0.30	150~300	0.10~0.35	150~300	0.10~0.35		200~300	0.05~0.30	150~300	0.10~0.35	
M	PC9530	90~150	0.05~0.25	90~150	0.10~0.35	-	-	RM8E 9.0	90~150	0.10~0.30	90~150	0.10~0.35	RM8E 11
	PC5300	90~150	0.05~0.25	90~150	0.10~0.35	-	-		90~150	0.10~0.30	90~150	0.10~0.35	
K	PC6510	150~300	0.08~0.35	150~300	0.10~0.40	150~300	0.10~0.40	RM8Q 11.5	150~300	0.08~0.35	150~300	0.10~0.40	
	PC5300	150~300	0.08~0.35	150~300	0.10~0.40	150~300	0.10~0.40		150~300	0.08~0.35	150~300	0.10~0.40	

Rich Mill RMH8

Features

- Screw on clamping system - Adaptable and Stable clamping system
- Reinforced rigidity and enhanced clamping power
 - Applying shim system, prevent cutter damage when insert breaks
- Adapting/exchangeable shim
 - Using various kinds of cutter (Approach angle 45°, 75°, 88°)
 - Stable clamping power with insert



RMH8A
(AA 45°)



RMH8E
(AA 75°)



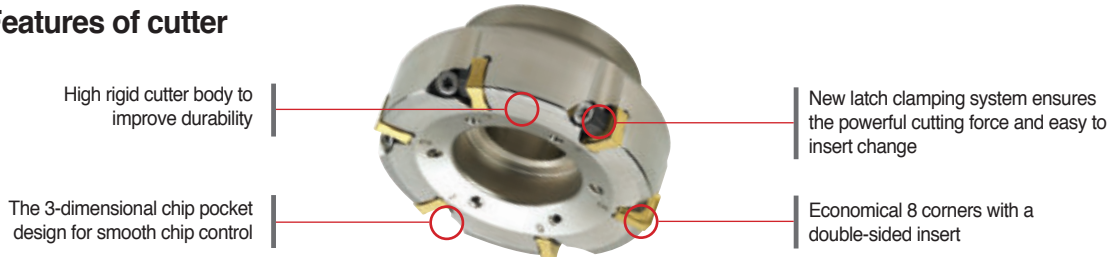
RMH8Q
(AA 88°)

Rich Mill RMT8

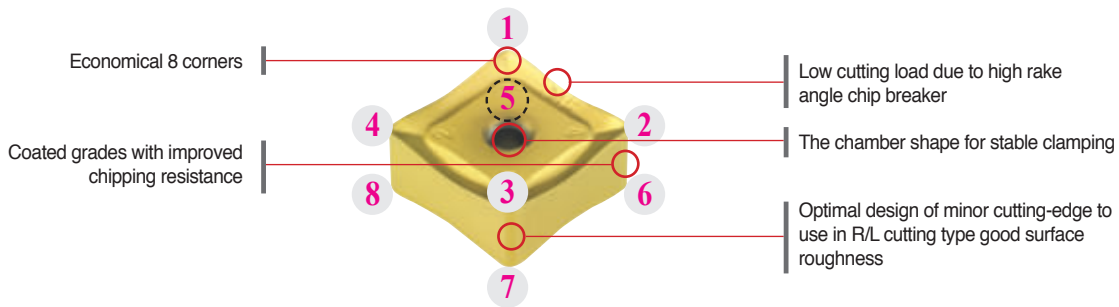
Features

- New latch clamping system provides a powerful cutting force and an easy insert change
- New grades with chipping resistance provides good surface roughness and better tool life
- Due to the specially designed chip breaker, all operations are possible
- RMT with various pitches can replace conventional ISO milling tool

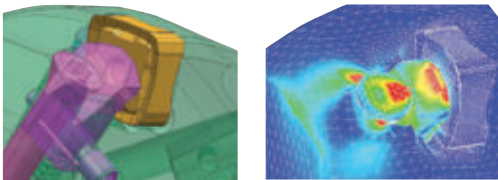
Features of cutter



Features of insert (Using R/L)



Clamping force analysis



Features of chip breakers

	Insert	Cutting-edge	Uses	Features
MF			For fine finishing	Our specialized insert design creates low cutting forces suitable for light cutting, HRSA
MM			For strengthen	Suitable geometry design for general milling has wider ranges of machining

Recommended grades and chip breakers

ISO	Grades	MM	MF
P	NCM535	⊙	○
	PC5300	⊙	○
M	PC9530	○	⊙
K	PC6510	○	⊙

⊙: Optimum ○: Proper

Recommended cutting condition

ISO	Grades	MM		MF	
		vc (m/min)	fz (mm/t)	vc (m/min)	fz (mm/t)
P	NC5330	190~310	0.10~0.35	190~310	0.05~0.30
	NCM535	160~270	0.10~0.35	160~270	0.05~0.30
	PC3700	130~210	0.10~0.35	130~210	0.05~0.30
M	PC9530	90~150	0.05~0.30	90~150	0.05~0.30
K	PC6510	140~230	0.10~0.40	140~230	0.08~0.35

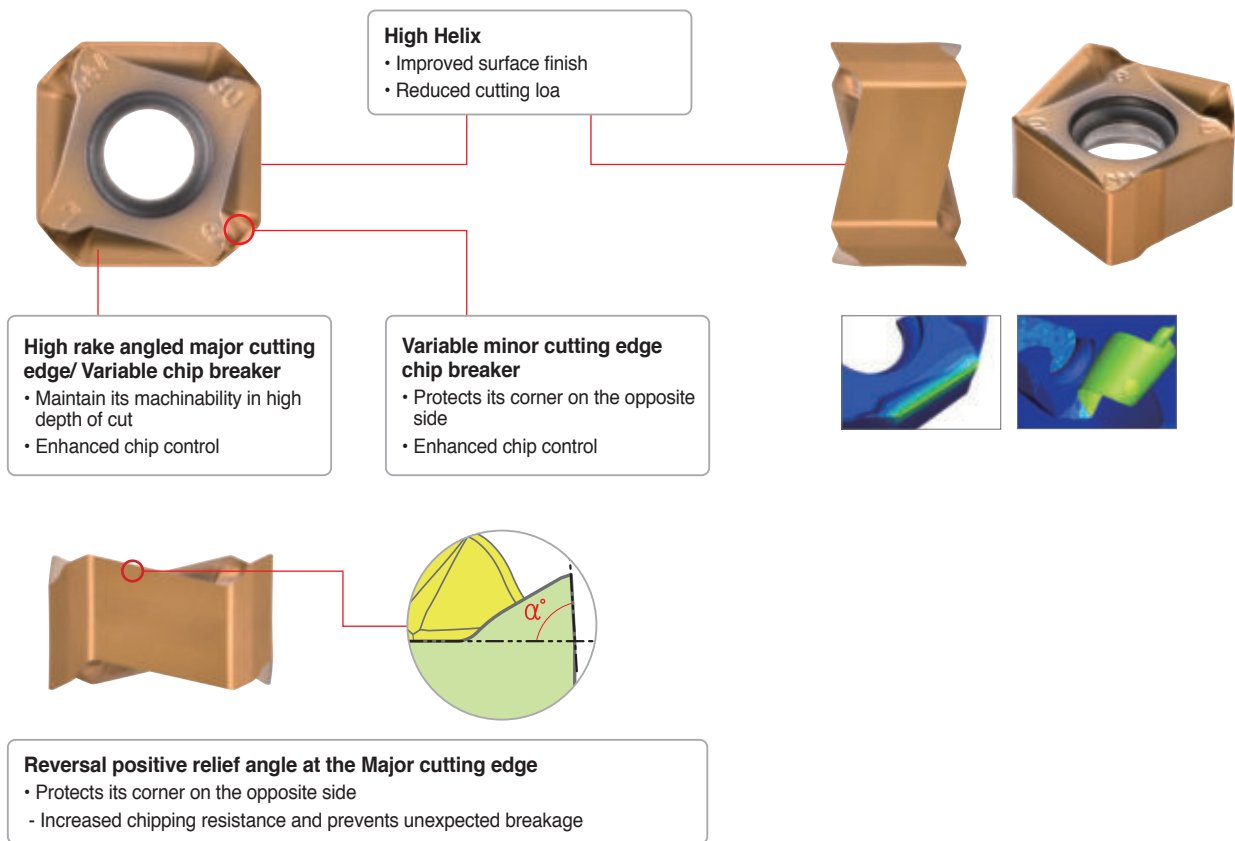


Rich Mill RM8-X

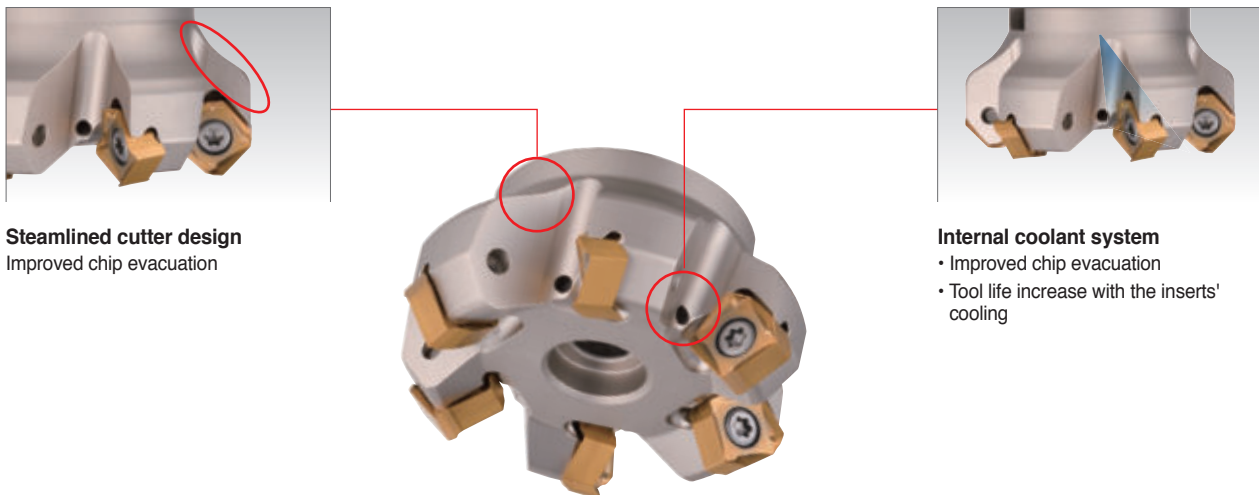
Features

- High helix face milling tool with 8-cornered double-side inserts
- High performance in stainless steel machining due to sharp cutting edge and double reverse positive relief surface structure
- Economic tool by double-sided 8 corners and high helix right-handed shape realizing high depth of cut machining

Insert features



Cutter features



Rich Mill RM8-X

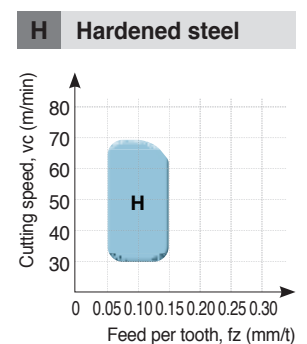
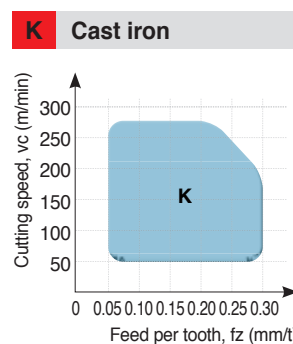
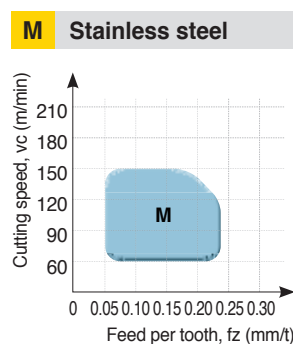
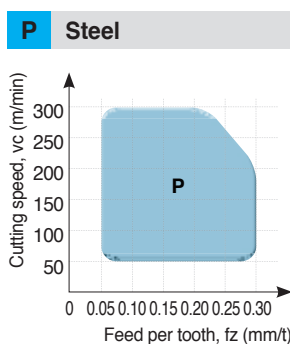
Recommended grade and cutting edge

Type	SAGX			SNMX	
Features	Strong relief surface			Relief surface for surface finish	
Workpiece	M	S	H	P	K
Geometry	<p>SAGX-ML SAGX-MM</p>			<p>SNMX-MM</p>	
	<p>[Double reverse positive relief surface]</p>			<p>[Negative relief surface]</p>	

Type	Recommended insert and grade for different workpieces (●: 1 st recommendation)									
	P		M		K		S		H	
	C/B	Grades	C/B	Grades	C/B	Grades	C/B	Grades	C/B	Grades
SAGX140808ANER	○ ML ○ MM	○ PC5300 ○ PC3700	● ML ○ MM	● PC9540 ○ PC5300	○ ML ○ MM	○ PC6510 ○ PC5300	● ML ○ MM	● PC5300	● MM	● PC2510 ○ PC2505
SNMX140808ANER	● MM	● PC3700	-	-	● MM	● PC6510	-	-	-	-

Recommended cutting condition

Grades	Machining types	Recommended grade	Recommended cutting speed (m/min)	ISO	Application range	
P	Steel	Continuous cutting	PC3700 ^{new}	235 (180~290)	P30	
		Interrupted cutting	PC5300	195 (150~240)	P40	
M	Stainless steel	Continuous cutting	PC5300	130 (100~160)	M20	
		Interrupted cutting	PC9540	110 (80~140)	M40	
K	Cast iron	Continuous cutting	PC6510	180 (140~230)	K05	
		Interrupted cutting	PC5300	145 (110~180)	K10	
					K20	
			K30			
H	Hardened steel	Continuous cutting	PC2510 ^{new}	55 (40~70)	H10	



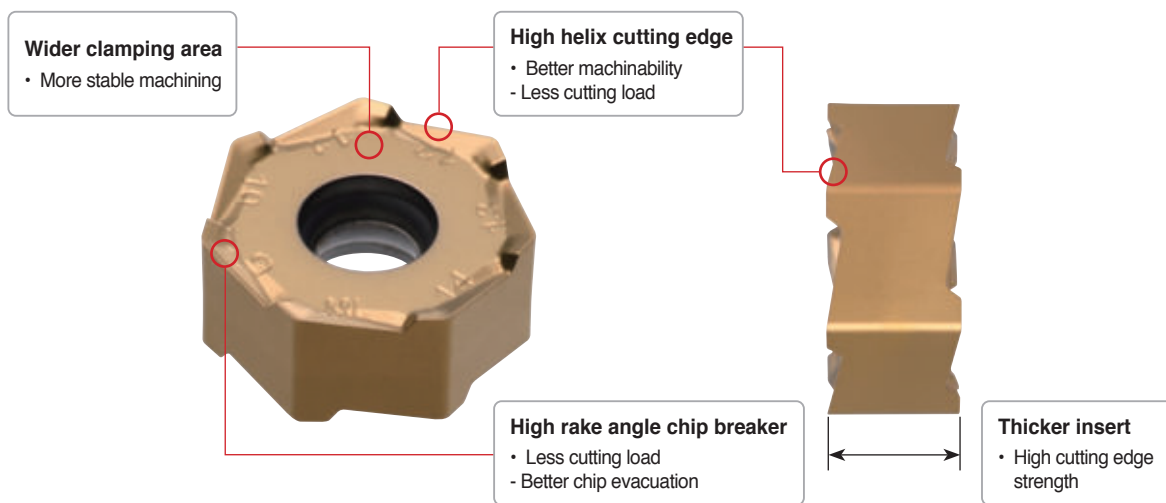
Rich Mill RM14

Features

- Economical face mill with 14 double-sided corners
- Minimized chattering of workpiece due to minimum lead angle and sharp cutting edge
- Reduced cutting resistance and improved chip emissions by high helix angle application

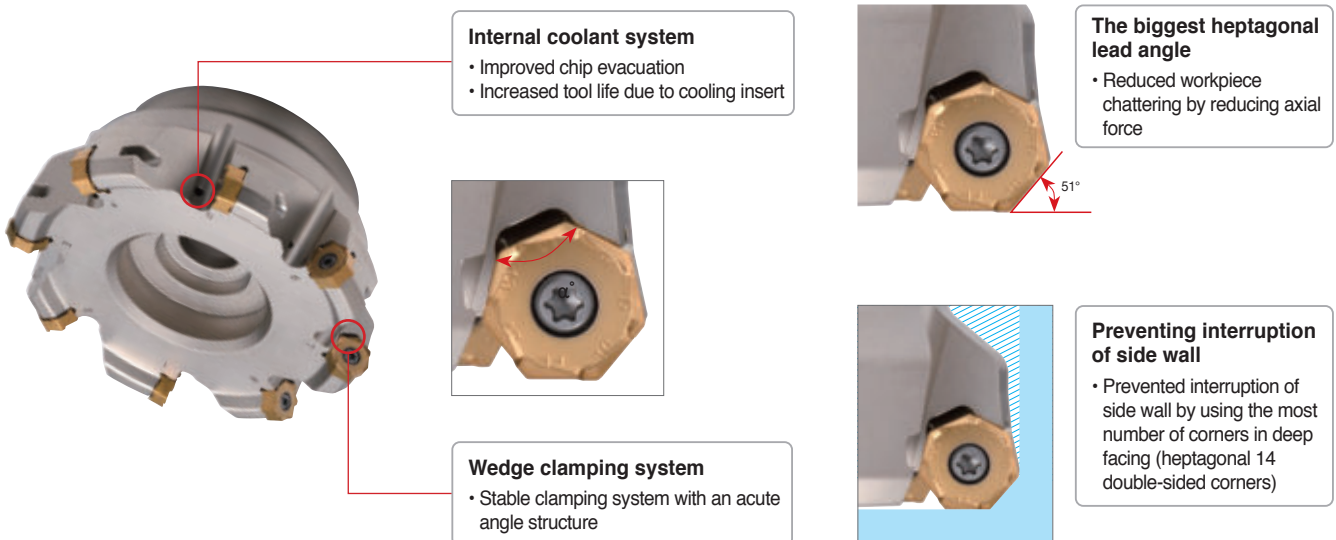
Insert features

- Wide supporting area of insert ensures stable clamping system.
- High rake angle cutting edge reduces cutting load and increases chip evacuation.
- Thicker insert realizes stability in machining.







Cutter features

- The biggest heptagonal lead angle reduces chatter in machining.
- Wedge type clamping system ensures stable clamping.
- Stepped machining is available without interruption of side wall of insert.





Rich Mill RM14

Features of chip breakers

Insert	Cutting-edge	Uses	Features
		Neutral type Flat cutting edge	1 st recommended for heat resistant stainless steel machining Generally applied in various machining Applicable for both right handed and left handed
		Right handed type High helix cutting edge	1 st recommended for cast iron machining Applicable for stainless steel machining with less than 3 mm depth of cut For high speed and high feed machining

Recommended grade and cutting edge

(● : 1st recommendation)

Type		Recommended grade and cutting edge by workpiece							
		M				K			
		Austenitic stainless steel		Heat resistance stainless steel		Gray cast iron		Ductile cast iron	
		Type	Grade	Type	Grade	Type	Grade	Type	Grade
Flat		-	● PC9540 ○ PC5300 ○ PC5400	●	● PC9540 ○ PC5300 ○ PC5400	-	○ PC6510 ○ PC5300 ● NCM535	-	● PC6510 ○ PC5300 ○ NCM535
Helix		●	● PC9540 ○ PC5300 ○ PC5400	-	● PC9540 ○ PC5300 ○ PC5400	●	○ PC6510 ○ PC5300 ● NCM535	●	● PC6510 ○ PC5300 ○ NCM535

Recommended cutting condition

ISO	Workpiece	ISO (DIN)*	AISI	KS	HB	Grades	Cutting conditions					
							Helix			Flat		
							vc (m/min)	fz (mm/t)	ap (mm)	vc (m/min)	fz (mm/t)	ap (mm)
M	Austenite	STS304 STS316	X5CrNi18-9 X5CrNiMo17-12-2	304 316	160-180	PC9540 (PC5300)	80-160	0.3-0.05	1-3	90-150	0.25-0.05	1-3
	Heat resistance stainless steel	-	(1.48□□)	-	160-200	PC9540 (PC5300)	60-100	0.2-0.05	1-2	60-100	0.25-0.05	1-3
K	Gray cast iron	GC250	250 (GG 25)	No 35 B	180-240	NCM535 (PC6510)	200-300	0.3-0.1	2-3	200-300	0.25-0.1	2-3
	Ductile cast iron	GCD500	500-7 (GGG 50)	80-55-06	150-230	PC6510 (PC5300)	110-230	0.3-0.1	2-3	150-200	0.3-0.1	2-3
		GCD600	600-3 (GGG 60)	-	170-270	PC6510 (PC5300)	85-200	0.25-0.15	2-3	150-200	0.25-0.15	2-3








Rich Mill RM16







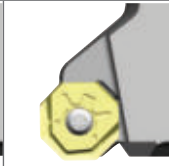
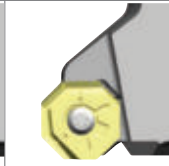
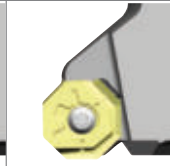
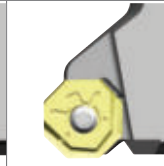
Features

- Economical 16 cutting-edges
- Reduces cost in medium cutting
- Wiper insert can be used for good surface roughness
- Optimal matching of the special cutting-edge geometry with variety of new grades provides consistence & long tool
- When it is used 16 corners, maximum cutting depth is 5.5 mm, but it is used 8 corners, maximum cutting depth is 13 mm
- Wiper insert is placed 0.05 mm lower than facing insert in cutter
- When feed is bigger than wiper cutting-edge length (7 mm), 2 wiper inserts are placed in symmetrical position

Features of chip breakers

Insert	Cutting-edge	Uses	Features
MA		For aluminum cutting light	With sharp edge application, the better productivity has been accomplished, especially for aluminum cutting
ML		For hard-to-cut material	Chip breaker with low cutting load is optimal for machining hard-to-cut materials
MF		For light cutting	Due to low cutting load, it is good for light cutting and difficult-to-cut material
MM		For general cutting	It is suitable design for general milling
W		For wiper	It has better surface roughness than MM and MF chip breakers

Instruction for wiper insert

Hand	Correct setting	Incorrect setting			
Right hand					
Decision	○	×	×	×	×
Left hand					
Decision	○	×	×	×	×

Through coolant system

- Well designed chip pocket for better chip flow
- Through coolant system reduces cutting heat and improves chip evacuation



Recommended cutting condition

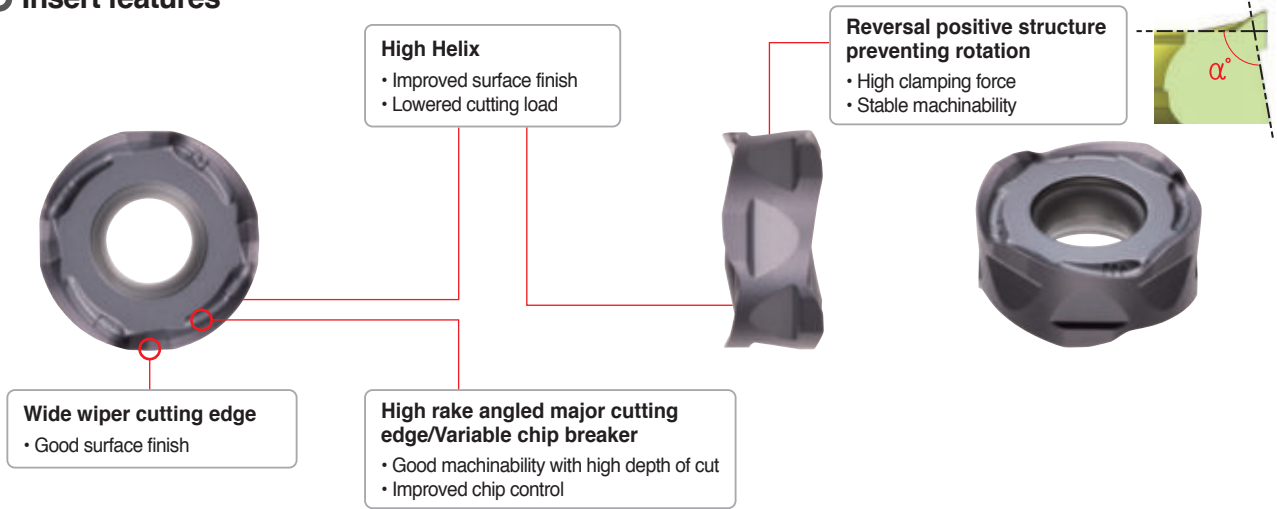
ISO	Grades	(mm)											
		ONM(H)X060608-MM		ONM(H)X060608-MF		ONHX060608-W		ONM(H)X080608-MM		ONM(H)X080608-MF		ONHX080608-W	
		vc (m/min)	fz (mm/t)	vc (m/min)	fz (mm/t)	vc (m/min)	fz (mm/t)	vc (m/min)	fz (mm/t)	vc (m/min)	fz (mm/t)	vc (m/min)	fz (mm/t)
P	NCM535	150~300	0.10~0.35	200~300	0.05~0.30	200~300	0.05~0.20	150~300	0.10~0.40	200~300	0.05~0.35	200~300	0.05~0.25
	PC3700	150~300	0.10~0.35	200~300	0.05~0.30	200~300	0.05~0.20	150~300	0.10~0.40	200~300	0.05~0.35	200~300	0.05~0.25
M	PC9530	120~180	0.10~0.35	100~180	0.05~0.30	100~180	0.05~0.20	120~180	0.10~0.40	100~180	0.05~0.35	100~180	0.05~0.25
K	PC6510	150~300	0.10~0.40	150~300	0.08~0.35	150~300	0.05~0.25	150~300	0.10~0.45	150~300	0.08~0.40	150~300	0.05~0.30

Rich Mill RMR

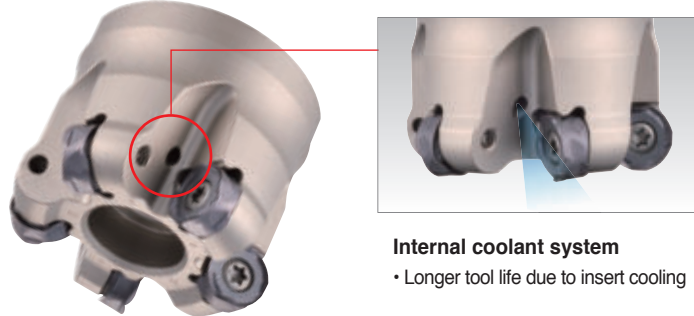
Features

- Improved machining stability with the combination of the reversal positive structure preventing rotation and wide upper and lower clamping sides.
- Helix cutting edge and sharp chip breaker realize smooth cutting.
- Wide minor cutting edge and optimized holder angle enhance high surface finish.

Insert features



Cutter features

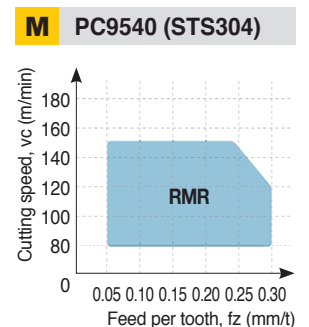
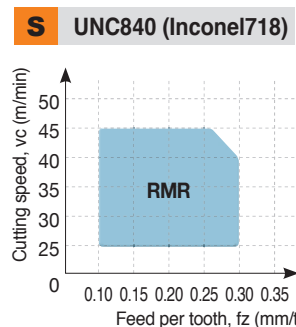


Recommended grade and cutting edge






Chip breaker	Cutting-edge	Recommended grade and cutting edge by workpiece (●: 1 st recommendation)	
		S	M
		Grade	Grade
ML		● UNC840 ○ UPC845	● PC9540 ○ UPC845

Recommended cutting condition











Workpiece	Grades	ISO	AISI	KS	Cutting conditions		
					vc (m/min)	fz (mm/t)	ap (mm)
S High temperature alloys	UNC840	15156-3	7718	Inconel718	30-50	0.4-0.1	1.0-3.0
	UPC845	15156-3	7718	Inconel718	20-40	0.6-0.2	1.5-4.0
M Stainless steel	PC9540	X5CrNi18-9	304	STS304	80-160	0.3-0.05	1.0-3.0
		X5CrNiMo17-12-2	316	STS316			



Cutters


Type	A.A	Designation	Shape	Cutter Diameter	Application	Features	Page		
RM3	90°	RM3PC(M)3000		Ø40~Ø80	XNKT060405PNER-ML XNKT060405PNSR-MM		E99		
		RM3PC(M)4000		Ø40~Ø125	XNCT080508PNFR-MA XNKT080508PNER-ML XNKT080508PNSR-MM XNKT080516PNSR-MM XNKT080520PNSR-MM		<ul style="list-style-type: none"> Economical 3 corners Perfect perpendicularity Longer tool life due to direct injection into the cutting-edge of insert 	E100	
		RM3PC(M)5000 <small>new</small>		Ø80~Ø125	XNCT120608PNER-MA XNKT120608PNER-ML XNKT120612PNER-ML XNKT120616PNER-ML XNKT120620PNER-ML XNKT120608PNSR-MM XNKT120612PNSR-MM XNKT120616PNSR-MM XNKT120620PNSR-MM		E101		
RM4	90°	RM4PC(M)3000		Ø40~Ø100	LNEX100605PNR-MF LNMX100605aPNR-MF LNEX100605PNR-MM LNMX100605PNR-MM LNEX100608PNR-MF LNMX100608PNR-MF LNEX100608PNR-MM LNMX100608PNR-MM		E105		
		RM4PC(M)4000		Ø50~Ø160	LNEX151004PNR-MF LNMX151004PNR-MF LNEX151004PNR-MM LNMX151004PNR-MM LNEX151008PNR-MF LNMX151008PNR-MF LNEX151008PNR-MM LNMX151008PNR-MM LNEX151016PNR-MF LNMX151016PNR-MF LNEX151016PNR-MM LNMX151016PNR-MM LNEX151004PNR-MA LNEX151008PNR-MA LNEX151008PNL-MM LNMX151008PNL-MM		<ul style="list-style-type: none"> Economical 4 corners Screw on type for slotting, facing 	E106	
		RM4ZCM3000		Ø40~Ø52	LNEX100605PNL-MM LNMX100605PNL-MM			<ul style="list-style-type: none"> Economical 4 corners Optimal insert application for vertical machining 	E118
		RM4ZC(M)4000		Ø63~Ø100	LNEX151008PNL-MM LNMX151008PNL-MM				

Cutters










Type	A.A	Designation	Shape	Cutter Diameter	Application	Features	Page
RM6	90°	RM6PCM-WN04 <small>new</small>		Ø40~Ø63	WNGX040304PNFR-MA WNGX040312PNER-ML WNGX040308PNFR-MA WNGX040316PNER-ML WNGX040312PNFR-MA WNGX040304PNSR-MM WNGX040316PNFR-MA WNGX040308PNSR-MM WNGX040304PNER-ML WNGX040312PNSR-MM WNGX040308PNER-ML WNGX040316PNSR-MM	   <ul style="list-style-type: none"> Improved productivity and high-quality shouldering through high speed and high feed machining 	E120
		RM6PC(M)-WN08 <small>new</small>		Ø50~Ø125	WNGX080604PNFR-MA WNGX080616PNER-ML WNGX080608PNFR-MA WNGX080620PNER-ML WNGX080612PNFR-MA WNGX080604PNSR-MM WNGX080616PNFR-MA WNGX080608PNSR-MM WNGX080620PNFR-MA WNGX080612PNSR-MM WNGX080604PNER-ML WNGX080616PNSR-MM WNGX080608PNER-ML WNGX080620PNSR-MM WNGX080612PNER-ML		E121
RM8	45°	RM8AC(M)4000		Ø50~Ø400	SNEX1206ANN-MA SNEX1206ANN-MM SNEX1206ANN-MF SNMX1206ANN-MM SNMX1206ANN-MF SNEX1206ANN-W SNEX1206ANN-ML		E126
		RM8AC(M)5000		Ø80~Ø400	SNEX1507ANN-MF SNEX1507ANN-MM SNMX1507ANN-MF SNMX1507ANN-MM SNEX1507ANN-ML		E128
	75°	RM8EC(M)4000		Ø50~Ø400	SNEX1206ENN-MA SNEX1206ENN-ML SNEX1206ENN-MF SNEX1206ENN-MM SNMX1206ENN-MF SNMX1206ENN-MM	 <ul style="list-style-type: none"> Economical 8 corners Low cutting load and excellent smooth cutting 	E130
		RM8EC(M)5000		Ø80~Ø400	SNEX1507ENN-MF SNEX1507ENN-MM SNMX1507ENN-MF SNMX1507ENN-MM SNEX1507ENN-ML		E132
88°	RM8QC(M)4000		Ø63~Ø200	SNEX1206QNN-MA SNEX120612-MA SNEX1206QNN-MF SNEX120612-MF SNMX1206QNN-MF SNMX120612-MF SNEX1206QNN-ML SNEX120612-ML SNEX1206QNN-MM SNEX120612-MM SNMX1206QNN-MM SNMX120612-MM		E134	



Cutters

Type	A.A	Designation	Shape	Cutter Diameter	Application		Features	Page
RM8	45°	RMH8AC(M)4000		Ø50~Ø400	SNEX1206ANN-MA SNEX1206ANN-MF SNMX1206ANN-MF	SNEX1206ANN-ML SNEX1206ANN-MM SNMX1206ANN-MM SNEX1206ANN-W	<ul style="list-style-type: none"> • Economical 8 corners • Low cutting load and excellent smooth cutting 	E127
		RMH8AC(M)5000		Ø80~Ø400	SNEX1507ANN-MF SNMX1507ANN-MF SNEX1507ANN-ML	SNEX1507ANN-MM SNMX1507ANN-MM		E129
	75°	RMH8EC(M)4000		Ø50~Ø400	SNEX1206ENN-MA SNEX1206ENN-MF SNMX1206ENN-MF	SNEX1206ENN-ML SNEX1206ENN-MM SNMX1206ENN-MM		E131
		RMH8EC(M)5000		Ø80~Ø400	SNEX1507ENN-MF SNMX1507ENN-MF SNEX1507ENN-ML	SNEX1507ENN-MM SNMX1507ENN-MM		E133
RMT8	88°	RMH8QC(M)4000		Ø63~Ø200	SNEX1206QNN-MA SNEX1206QNN-MF SNMX1206QNN-MF SNEX1206QNN-ML SNEX1206QNN-MM SNMX1206QNN-MM	SNEX120612-MA SNEX120612-MF SNMX120612-MF SNEX120612-ML SNEX120612-MM SNMX120612-MM		E135
	45°	RMT8A(M) 4000/5000		Ø80~Ø315	SNCF1206ANN-MF SNCF1507ANN-MF SNMF1206ANN-MF SNMF1507ANN-MF	SNCF1206ANN-MM SNCF1507ANN-MM SNMF1206ANN-MM SNMF1507ANN-MM		E136
			E137					
75°	RMT8E(M) 4000/5000		Ø80~Ø315	SNCF1206ENN-MF SNCF1507ENN-MF SNMF1206ENN-MF SNMF1507ENN-MF	SNCF1206ENN-MM SNCF1507ENN-MM SNMF1206ENN-MM SNMF1507ENN-MM		E138	
		E139						
88°	RMT8Q(M)4000		Ø80~Ø315	SNCF1206QNN-MF	SNMF1206QNN-MF		E140	

Cutters





Type	A.A	Designation	Shape	Cutter Diameter	Application		Features	Page
RM8-X	45°	RMX8AC(M)-SA14 <small>new</small>		Ø50~Ø125	SAGX140808ANER-ML SAGX140808ANER-MM SNMX140808ANER-MM		<ul style="list-style-type: none"> • Double sided insert with 8 corners • Stable cutting performance due to double reversal positive relief surface • Good machinability in stainless cutting with High helix cutting edge 	E141
RM14	51°	RM14XCM-XN06 <small>new</small>		Ø50~Ø160	XNMX0606XNR-ML XNMX060608-ML	 	<ul style="list-style-type: none"> • Reduced vibration with the application of maximum approach angle on heptagonal shape • Stable clamping from wedge type clamping structure • Available for multiple-staged cutting without interference of the cutter's side wall 	E 142
RM16	45°	RM16AC(M) 6000/8000		Ø63~Ø400	ONHX060608-MF ONMX060608-MF ONHX0606ANN-MF ONMX0606ANN-MF ONHX080608-MF ONMX080608-MF ONHX0806ANN-MF ONMX0806ANN-MF ONHX060608-ML ONMX060608-ML ONHX080608-ML ONMX080608-ML ONMX060608-MM ONHX0606ANN-MM ONMX0606ANN-MM ONHX080608-MM ONMX080608-MM ONHX0806ANN-MM ONMX0806ANN-MM ONHX060608-MA ONMX060608-MA ONHX080608-MA ONMX080608-MA ONHX060608-W ONMX060608-W ONHX080608-W ONMX080608-W		<ul style="list-style-type: none"> • Economical 16 corners • Wiper insert for surface roughness 	E143 E144
RMR	-	RMRC(M)-RN12 <small>new</small>		Ø50~Ø125	RNMX1204M0E-ML		<ul style="list-style-type: none"> • High cost efficiency due to double sided round typed cutting edge • Excellent rotating prevention by strong clamping system • Suitable for Inconel cutting 	E145



Shanks/Modulars

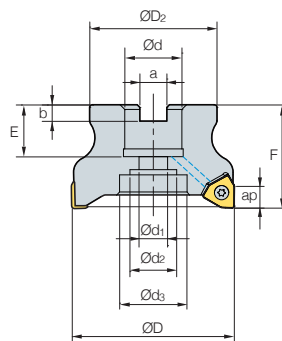
Type	A.A	Designation	Shape	Cutter Diameter	Application	Features	Page
RM3	90°	RM3PS3000 <small>new</small>		Ø20~Ø40	XNKT060405PNER-ML XNKT060405PNSR-MM	 <ul style="list-style-type: none"> Economical 3 corners Perfect perpendicular shouldering operation multi milling tool 	E102
		RM3PS4000 <small>new</small>		Ø32~Ø63	XNKT080508PNER-ML XNKT080508PNSR-MM XNKT080512PNSR-MM		E103
		RM3PM <small>new</small> 3000/4000		Ø20~Ø50	XNKT060405PNER-ML XNKT060405PNSR-MM XNKT060408PNER-ML XNKT060408PNSR-MM XNCT080504PNFR-MA XNCT080508PNFR-MA XNCT080512PNFR-MA XNCT080520PNFR-MA XNKT080508PNER-ML XNKT080508PNSR-MM XNKT080512PNER-ML XNKT080512PNSR-MM XNKT080516PNER-ML XNKT080516PNSR-MM XNKT080520PNER-ML XNKT080520PNSR-MM		E104
RM4PS3000	Ø14~Ø50	LNEX100605PNR-MF LNMX100605PNR-MF LNEX100605PNR-MM LNMX100605PNR-MM LNEX100608PNR-MF LNMX100608PNR-MF LNEX100608PNR-MM LNMX100608PNR-MM LNEX100605PNR-MA LNEX100605PNL-MM LNEX100608PNR-MA LNEX100608PNL-MM		E115			
RM4	90°	RM4PS4000		Ø32~Ø63	LNEX151004PNR-MF LNMX151004PNR-MF LNEX151004PNR-MM LNMX151004PNR-MM LNEX151008PNR-MF LNMX151008PNR-MF LNEX151008PNR-MM LNMX151008PNR-MM LNEX151016PNR-MF LNEX151016PNR-MM LNEX151016PNR-MA LNEX151016PNL-MM LNEX151008PNR-MA LNEX151008PNL-MM LNEX151008PNR-MM LNEX151008PNL-MM LNEX151016PNR-MA LNEX151016PNL-MM LNEX151016PNR-MM LNEX151016PNL-MM	E116	
		RM4ZS3000		Ø25~Ø40	LNEX100605PNL-MM LNMX100605PNL-MM	  <ul style="list-style-type: none"> Economical 4 corners Optimal insert application for vertical machining 	E119
	RM4PM3000		Ø14~Ø50	LNEX100605PNR-MF LNMX100605PNR-MF LNEX100605PNR-MM LNMX100605PNR-MM LNEX100608PNR-MF LNMX100608PNR-MF LNEX100608PNR-MM LNMX100608PNR-MM LNEX100605PNR-MA LNEX100605PNL-MM LNEX100608PNR-MA LNEX100608PNL-MM	E117		
	RM4ZM3000		Ø25~Ø40	LNEX100605PNL-MM LNMX100605PNL-MM	<ul style="list-style-type: none"> Economical 4 corners Optimal insert application for vertical machining 	E119	

Shanks/Modulars

Type	A.A	Designation	Shape	Cutter Diameter	Application	Features	Page
RM6	90°	RM6PS-WN04 <small>new</small>		Ø20~Ø32	WNGX040304PNFR-MA WNGX040312PNER-ML WNGX040308PNFR-MA WNGX040316PNER-ML WNGX040312PNFR-MA WNGX040304PNSR-MM WNGX040316PNFR-MA WNGX040308PNSR-MM WNGX040304PNER-ML WNGX040312PNSR-MM WNGX040308PNER-ML WNGX040316PNSR-MM		E122
		RM6PS-WN08 <small>new</small>		Ø32~Ø50	WNGX080604PNFR-MA WNGX080616PNER-ML WNGX080608PNFR-MA WNGX080620PNER-ML WNGX080612PNFR-MA WNGX080604PNSR-MM WNGX080616PNFR-MA WNGX080608PNSR-MM WNGX080620PNFR-MA WNGX080612PNSR-MM WNGX080604PNER-ML WNGX080616PNSR-MM WNGX080608PNER-ML WNGX080620PNSR-MM WNGX080612PNER-ML		E123
		RM6PM-WN04 <small>new</small>		Ø20~Ø32	WNGX040304PNFR-MA WNGX040312PNER-ML WNGX040308PNFR-MA WNGX040316PNER-ML WNGX040312PNFR-MA WNGX040304PNSR-MM WNGX040316PNFR-MA WNGX040308PNSR-MM WNGX040304PNER-ML WNGX040312PNSR-MM WNGX040308PNER-ML WNGX040316PNSR-MM		E124
		RM6PM-WN08 <small>new</small>		Ø32~Ø40	WNGX080604PNFR-MA WNGX080616PNER-ML WNGX080608PNFR-MA WNGX080620PNER-ML WNGX080612PNFR-MA WNGX080604PNSR-MM WNGX080616PNFR-MA WNGX080608PNSR-MM WNGX080620PNFR-MA WNGX080612PNSR-MM WNGX080604PNER-ML WNGX080616PNSR-MM WNGX080608PNER-ML WNGX080620PNSR-MM WNGX080612PNER-ML		E125
RMR	-	RMRS-RN12 <small>new</small>		Ø32~Ø63	RNMX1204M0E-ML	<ul style="list-style-type: none"> High cost efficiency due to double sided round typed cutting edge Excellent rotating prevention by strong clamping system Suitable for Inconel cutting 	E146



RM3PC(M)3000 new



AA
90°

• AR: -5°
• RR: -9°~6°

Designation		⊙	ØD	ØD2	Ød	Ød1	Ød2	Ød3	a	b	E	F	ap	
RM3PCM	3040HR	5	40	35	16	9	14	-	8.4	5.6	16	40	5.5	0.2
	3040HR-M	6	40	35	16	9	14	-	8.4	5.6	16	40	5.5	0.2
	3050HR	6	50	41	22	11	18	-	10.4	6.3	20	40	5.5	0.3
	3050HR-M	7	50	41	22	11	18	-	10.4	6.3	20	40	5.5	0.3
	3063HR	7	63	49	22	11	18	-	10.4	6.3	20	40	5.5	0.49
	3063HR-M	8	63	49	22	11	18	-	10.4	6.3	20	40	5.5	0.49
RM3PC (RM3PCM)	3080HR	8	80	57	25.4 (27)	14	25	35	9.5 (12.4)	6 (7)	25 (23)	50	5.5	0.87
	3080HR-M	10	80	57	25.4 (27)	14	25	35	9.5 (12.4)	6 (7)	25 (23)	50	5.5	0.88

(mm)

() Metric size

Available inserts

XNKT-ML

XNKT-MM



Designation	Cermet		Coated										Uncoated			page		
	CN2500	CN30	NC5300	NCM325	NCM335	NCM535	NCM545	PC2505	PC2510	PC3700	PC6510	PC9530	PC9540	PC5300	PC5400		ST30A	G10
XNKT	060405PNER-ML							●	●	●		●	●	●				
	060405PNSR-MM							●	●	●	●	●	●	●				
	060408PNER-ML										●			●	●			
	060408PNSR-MM							●	●	●	●			●	●			

E32

Available arbors

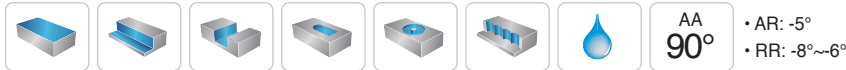
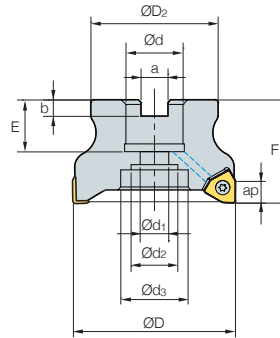
Designation	Available arbors	
	RM3PC	RM3PCM
RM3PC(M)	3040HR	
	3040HR-M	BT□□-FMC16-□□
	3050HR	
	3050HR-M	BT□□-FMC22-□□
	3063HR	
	3063HR-M	
	3080HR	BT□□-FMA25.4-□□
	3080HR-M	BT□□-FMC27-□□

Parts

Specification		
Ø40~Ø80	FTNA0306	TW09S

Available inserts E32 Available arbors and bolt E426~E428

RM3PC(M)4000 new



(mm)

Designation	Inserts	ØD	ØD2	Ød	Ød1	Ød2	Ød3	a	b	E	F	ap	kg	
RM3PCM	4040HR	3	40	35	16	9	14	-	8.4	5.6	19	40	8.0	0.19
	4040HR-M	4	40	35	16	9	14	-	8.4	5.6	19	40	8.0	0.19
	4050HR	4	50	42	22	11	18	-	10.4	6.3	20	40	8.0	0.28
	4050HR-M	5	50	42	22	11	18	-	10.4	6.3	20	40	8.0	0.29
	4063HR	5	63	49	22	11	18	-	10.4	6.3	20	40	8.0	0.54
	4063HR-M	6	63	49	22	11	18	-	10.4	6.3	20	40	8.0	0.53
RM3PC (RM3PCM)	4080HR	5	80	57	25.4 (27)	14	20	35	9.5 (12.4)	6 (7)	25 (23)	50	8.0	1.08
	4080HR-M	7	80	57	25.4 (27)	14	20	35	9.5 (12.4)	6 (7)	25 (23)	50	8.0	1.06
	4100HR	7	100	67	31.75 (32)	18	26	42	12.7 (14.4)	8 (8)	33 (25)	63 (50)	8.0	1.68
	4100HR-M	8	100	67	31.75 (32)	18	26	42	12.7 (14.4)	8 (8)	33 (25)	63 (50)	8.0	1.67
	4125HR	8	125	90	38.1 (40)	22	32	52	15.9 (16.4)	9 (10)	38 (29)	63	8.0	3.45
	4125HR-M	10	125	90	38.1 (40)	22	32	52	15.9 (16.4)	9 (10)	38 (29)	63	8.0	3.45

Available inserts

() Metric size



Designation	Cermet		Coated										Uncoated			page			
	CN2500	CN30	NC5330	NCM325	NCM335	NCM535	NCM545	PC2505	PC2510	PC3700	PC6510	PC9530	PC9540	PC5300	PC5400		ST30A	G10	H01
XNCT	080504PNFR-MA																	●	E31 E32
	080508PNFR-MA																	●	
	080512PNFR-MA																	●	
	080520PNFR-MA																	●	
XNKT	080504PNER-ML													●	●				
	080504PNSR-MM									●				●	●				
	080508PNER-ML					●			●	●	●		●	●	●				
	080508PNSR-MM					●		●	●	●	●		●	●	●				
	080512PNER-ML													●	●				
	080512PNSR-MM								●	●	●			●	●				
	080516PNER-ML													●	●				
	080516PNSR-MM								●	●	●			●	●				
	080520PNER-ML													●	●				
	080520PNSR-MM								●	●				●	●				

Available arbors

Designation	Available arbors	
	RM3PC	RM3PCM
RM3PC(M) 4040HR	-	BT□□-FMC16-□□
4050HR	-	BT□□-FMC22-□□
4063HR		
4080HR	BT□□-FMA25.4-□□	BT□□-FMC27-□□
4100HR	BT□□-FMA31.75-□□	BT□□-FMC32-□□
4125HR	BT□□-FMA38.1-□□	BT□□-FMC40-□□

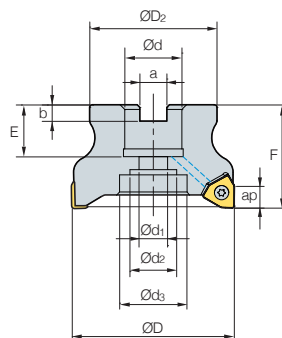
Parts

Specification	Screw	Wrench
Ø40~Ø125	FTNA0408	TW15S

Available inserts E31, E32 Available arbors and bolt E426~E428



RM3PC(M)5000 new



AA
90°
• AR: -5°
• RR: -7°

Designation			ØD	ØD2	Ød	Ød1	Ød2	Ød3	a	b	E	F	ap	
RM3PC (RM3PCM)	5080HR	5	80	57	25.4 (27)	14	20	35	9.5 (12.4)	6 (7)	24 (23)	50	12.0	0.84
	5080HR-M	7	80	57	25.4 (27)	14	20	35	9.5 (12.4)	6 (7)	24 (23)	50	12.0	0.84
	5100HR	7	100	67	31.75 (32)	18	28	45	12.7 (14.4)	8 (8)	32 (25)	63	12.0	1.76
	5100HR-M	8	100	67	31.75 (32)	18	28	45	12.7 (14.4)	8 (8)	32 (25)	63	12.0	1.76
	5125HR	8	125	90	38.1 (40)	22	32	52	15.9 (16.4)	9 (10)	38 (30)	63	12.0	2.70
	5125HR-M	10	125	90	38.1 (40)	22	32	52	15.9 (16.4)	9 (10)	38 (30)	63	12.0	2.70

(mm)

() Metric size

Available inserts

XNCT-MA XNKT-ML XNKT-MM



Designation	Cermet		Coated											Uncoated			page										
	CN2500	CN30	NC5330	NCM325	NCM335	NCM535	NCM545	PC2505	PC2510	PC3700	PC6510	PC9530	PC9540	PC5300	PC5400	ST30A		G10	H01								
XNCT	120608PNFR-MA																										
XNKT	120604PNSR-MM																										
	120608PNER-ML																										
	120608PNSR-MM																										
	120612PNER-ML																										
	120612PNSR-MM																										
	120616PNER-ML																										
	120616PNSR-MM																										
	120620PNER-ML																										
	120620PNSR-MM																										

E31
E32

Available arbors

Designation	Available arbors			
	RM3PC		RM3PCM	
RM3PC(M) 5080HR	BT□□	-FMA25.4-□□	BT□□	-FMC27-□□
5100HR	BT□□	-FMA31.75-□□	BT□□	-FMC32-□□
5125HR	BT□□	-FMA38.1-□□	BT□□	-FMC40-□□

Parts

Specification		
Ø80-Ø125	FTNA0511	TW20-100

Available inserts E31, E32 Available arbors and bolt E426~E428

RM3PS3000 new

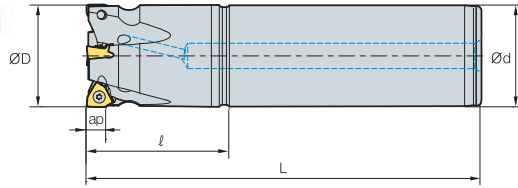


Fig. 1

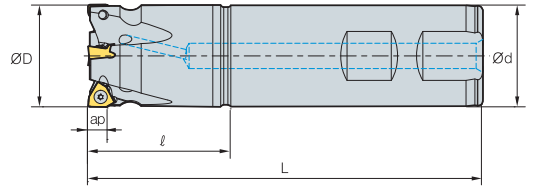
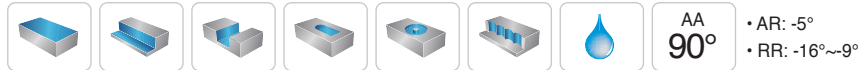


Fig. 2



AA
90°

• AR: -5°
• RR: -16°~9°

(mm)

Designation		ØD	Ød	l	L	ap		Fig.
RM3PS 3020HR-2S20	2	20	20	35	100	5.5	0.21	2
3020HR-2L20	2	20	20	35	200	5.5	0.43	1
3021HR-2S20	2	21	20	30	100	5.5	0.21	2
3021HR-2L20	2	21	20	30	200	5.5	0.43	1
3025HR-3S20	3	25	20	35	115	5.5	0.27	2
3025HR-3L20	3	25	20	35	200	5.5	0.46	1
3025HR-3S25	3	25	25	40	115	5.5	0.36	2
3025HR-3L25	3	25	25	40	200	5.5	0.66	1
3026HR-2S20	2	26	20	35	115	5.5	0.29	2
3026HR-2L20	2	26	20	35	200	5.5	0.47	1
3026HR-3S20	3	26	20	35	115	5.5	0.28	2
3026HR-3L20	3	26	20	35	200	5.5	0.47	1
3026HR-2S25	2	26	25	35	115	5.5	0.37	2
3026HR-2L25	2	26	25	35	200	5.5	0.68	1
3026HR-3S25	3	26	25	35	115	5.5	0.37	2
3026HR-3L25	3	26	25	35	200	5.5	0.68	1
3032HR-3S25	3	32	25	42	125	5.5	0.48	2
3032HR-3L25	3	32	25	42	200	5.5	0.74	1
3032HR-4S25	4	32	25	42	125	5.5	0.48	2
3032HR-4L25	4	32	25	42	200	5.5	0.74	1
3032HR-4S32	4	32	32	42	125	5.5	0.68	2
3032HR-4L32	4	32	32	42	200	5.5	1.13	1
3033HR-3S25	3	33	25	42	125	5.5	0.49	2
3033HR-3L25	3	33	25	42	200	5.5	0.75	1
3033HR-4S25	4	33	25	42	125	5.5	0.49	2
3033HR-4L25	4	33	25	42	200	5.5	0.75	1
3033HR-4S32	4	33	32	42	125	5.5	0.70	2
3033HR-4L32	4	33	32	42	200	5.5	1.14	1
3040HR-4S32	4	40	32	45	130	5.5	0.83	2
3040HR-4L32	4	40	32	45	200	5.5	1.24	1
3040HR-5S32	5	40	32	45	130	5.5	0.83	2
3040HR-5L32	5	40	32	45	200	5.5	1.24	1

Available inserts

XNKT-ML XNKT-MM



Designation	Cermet		Coated										Uncoated			page			
	CN2500	CN30	NC5330	NCM325	NCM335	NCM535	NCM545	PC2505	PC2510	PC3700	PC6510	PC9530	PC9540	PC5300	PC5400		ST30A	G10	H01
XNKT 060405PNER-ML								●	●	●	●		●	●	●				E32
060405PNSR-MM								●	●	●	●		●	●	●				
060408PNER-ML														●	●				
060408PNSR-MM								●	●	●	●		●	●	●				

Parts

Specification		
Ø20~Ø40	Screw FTNA0306	Wrench TW09S

Available inserts E32



RM3PS4000 new

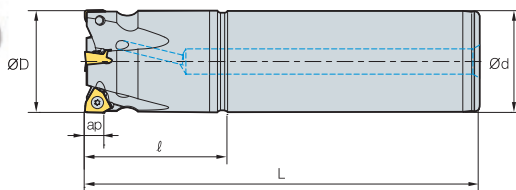


Fig. 1

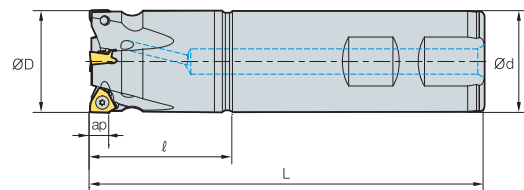


Fig. 2



AA
90°

• AR: -5°
• RR: -11°~7°

(mm)

Designation		ØD	Ød	ℓ	L	ap		Fig.
RM3PS 4032HR-3S32	3	32	32	42	125	8	0.67	2
4032HR-3L32	3	32	32	42	200	8	1.11	1
4033HR-3S32	3	33	32	42	125	8	0.68	2
4033HR-3L32	3	33	32	42	200	8	1.13	1
4040HR-3S32	3	40	32	42	130	8	0.8	2
4040HR-3L32	3	40	32	42	200	8	1.21	1
4040HR-4S32	4	40	32	42	130	8	0.81	2
4040HR-4L32	4	40	32	42	200	8	1.22	1
4050HR-4S32	4	50	32	42	135	8	0.99	2
4050HR-4L32	4	50	32	42	200	8	1.38	1
4050HR-4S40	4	50	40	42	135	8	1.32	2
4050HR-4L40	4	50	40	42	200	8	1.94	1
4050HR-5S32	5	50	32	42	135	8	1.02	2
4050HR-5L32	5	50	32	42	200	8	1.4	1
4050HR-5S40	5	50	40	42	135	8	1.35	2
4050HR-5L40	5	50	40	42	200	8	1.96	1
4063HR-5S32	5	63	32	42	135	8	1.31	2
4063HR-5L32	5	63	32	42	200	8	1.7	1
4063HR-5S40	5	63	40	42	135	8	1.64	2
4063HR-5L40	5	63	40	42	200	8	2.25	1
4063HR-6S32	6	63	32	42	135	8	1.31	2
4063HR-6L32	6	63	32	42	200	8	1.7	1
4063HR-6S40	6	63	40	42	135	8	1.64	2
4063HR-6L40	6	63	40	42	200	8	2.26	1

Available inserts



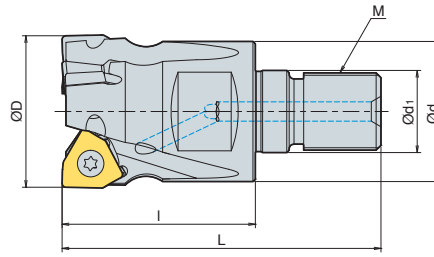
Designation	Cermet		Coated										Uncoated			page			
	CN2500	CN30	NC5330	NCM225	NCM335	NCM535	NCM545	PC2505	PC2510	PC3700	PC6510	PC9530	PC9540	PC5300	PC5400		ST30A	G10	H01
XNCT 080504PNFR-MA																		●	E31
080508PNFR-MA																		●	
080512PNFR-MA																		●	
080520PNFR-MA																		●	
XNKT 080504PNER-ML														●	●				E32
080504PNSR-MM														●	●				
080508PNER-ML						●			●	●			●	●					
080508PNSR-MM						●		●	●	●			●	●					
080512PNER-ML									●	●				●	●				
080512PNSR-MM								●	●	●				●	●				
080516PNER-ML									●	●				●	●				
080516PNSR-MM								●	●	●				●	●				
080520PNER-ML									●	●				●	●				
080520PNSR-MM								●	●	●				●	●				

Parts

Specification		
Ø32-Ø63	FTNA0408	TW15S

Available inserts E31, E32

RM3PM3000/4000 new



AA **90°**
 • AR: -5°
 • RR: -16°~7°

(mm)

Designation		ØD	Ød	Ød1	I	L	M	ap	
RM3PM	3020HR-2-M10	2	20	18	10.5	30	M10	5.5	0.06
	3025HR-3-M12	3	25	21	12.5	35	M12	5.5	0.1
	3032HR-4-M16	4	32	29	17	40	M16	5.5	0.21
	3040HR-5-M16	5	40	29	17	40	M16	5.5	0.26
RM3PM	4032HR-3-M16	3	32	29	17	40	M16	8	0.21
	4040HR-4-M16	4	40	29	17	50	M16	8	0.33
	4050HR-5-M16	5	50	29	17	55	M16	8	0.49

Available inserts

XNCT-MA XNKT-ML XNKT-MM



Designation	Cermet		Coated										Uncoated			page			
	CN2500	CN30	NC5330	NCM325	NCM335	NCM535	NCM545	PC2505	PC2510	PC3700	PC6510	PC9530	PC9540	PC5300	PC5400		ST30A	G10	H01
3000 type	XNKT	060405PNER-ML							●	●	●		●	●	●				
		060405PNSR-MM						●	●	●			●	●	●				
		060408PNER-ML									●			●	●				
		060408PNSR-MM						●	●	●	●			●	●				
4000 type	XNCT	080504PNFR-MA																●	
		080508PNFR-MA																●	
		080512PNFR-MA																●	
		080520PNFR-MA																●	
	XNKT	080504PNER-ML													●	●			
		080504PNSR-MM									●				●	●			
		080508PNER-ML						●							●	●			
		080508PNSR-MM						●		●	●	●		●	●	●			
		080512PNER-ML								●	●				●	●			
		080512PNSR-MM								●	●				●	●			
		080516PNER-ML													●	●			
		080516PNSR-MM								●	●				●	●			
080520PNER-ML													●	●					
080520PNSR-MM								●	●				●	●					

Available adaptor

Designation	Available adaptor	
RM3PM	3020HR-2-M10	MAT-M10
	3025HR-3-M12	MAT-M12
	3032HR-4-M16	MAT-M16
	3040HR-5-M16	MAT-M16
RM3PM	4032HR-3-M16	MAT-M16
	4040HR-4-M16	MAT-M16
	4050HR-5-M16	MAT-M16

Designation : RM3PM4032HR-M16
 Modular head threading measure size (M16)

II

Adaptor spec.: MAT-M16-035-S32S
 Adaptor threading measure (M16)

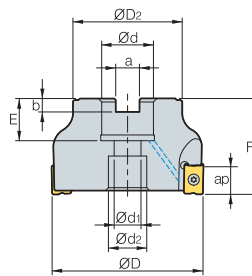
Parts

Specification		
Ø20~Ø40 (3000 type)	FTNA0306	TW09S
Ø32~Ø50 (4000 type)	FTNA0408	TW15S

Available inserts E31, E32 Available adaptor E401~E402



RM4PC(M)3000



AA
90°

• AR: -6°
• RR: -19°~13°

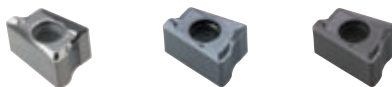
(mm)

Designation		ØD	ØD2	Ød	Ød1	Ød2	a	b	E	F	ap		Bolt	
RM4PCM	3040HR	4	40	35	16	9	14	8.4	5.6	19	40	9.0	0.24	SB0825
	3040HR-M	5	40	35	16	9	14	8.4	5.6	19	40	9.0	0.23	SB0825
	3050HR	5	50	42	22	11	18	10.4	6.3	20	40	9.0	0.36	SB1025
	3050HR-M	7	50	42	22	11	18	10.4	6.3	20	40	9.0	0.35	SB1025
	3063HR	7	63	49	22	11	18	10.4	6.3	20	40	9.0	0.61	SB1025
3063HR-M	9	63	49	22	11	18	10.4	6.3	20	40	9.0	0.6	SB1025	
RM4PC (RM4PCM)	3080HR	8	80	57	25.4 (27)	14	20	9.5 (12.4)	6.0 (7.0)	25 (23)	50	9.0	1.25 (1.24)	SB1230
	3080HR-M	10	80	57	25.4 (27)	14	20	9.5 (12.4)	6.0 (7.0)	25 (23)	50	9.0	1.24 (1.23)	SB1230
	3100HR	9	100	67	31.75 (32)	18	26	12.7 (14.4)	8.0 (8.0)	33 (25)	63 (50)	9.0	2.46 (1.94)	SB1630
	3100HR-M	12	100	67	31.75 (32)	18	26	12.7 (14.4)	8.0 (8.0)	33 (25)	63 (50)	9.0	2.44 (1.93)	SB1630

()Metric size

Available inserts

LNEX-MA LNM(E)X-MF LNM(E)X-MM



Designation	Cermet		Coated											Uncoated			page	
	CN2500	CN80	NC5330	NCM325	NCM335	NCM535	NCM545	PC2505	PC2010	PC3700	PC6510	PC9530	PC9540	PC5300	PC5400	ST30A		G10
LNEX	100605PNR-MF										●			●	●			
	100605PNR-MM									●	●			●	●			
	100605PNR-MA																	●
	100608PNR-MF									●	●			●	●			
	100608PNR-MM										●			●	●			
LNMX	100605PNR-MF										●			●	●			
	100605PNR-MM									●	●	●		●	●			
	100608PNR-MF										●			●	●			
	100608PNR-MM									●				●	●			

E11

Available arbors

Designation	Available arbors	
	RM4PC	RM4PCM
RM4PC(M)	3040HR	BT□□-FMC16-□□
	3040HR-M	
	3050HR	
	3050HR-M	BT□□-FMC22-□□
	3063HR	
	3063HR-M	

Designation	Available arbors	
	RM4PC	RM4PCM
RM4PC(M)	3080HR	BT□□-FMA25.4-□□
	3080HR-M	
	3100HR	BT□□-FMA31.75-□□
	3100HR-M	

Parts

Specification		
Ø40~Ø100	FTKA0307	TW09S

Available inserts E11 Available arbors and bolt E426~E428

RM4PC(M)4000

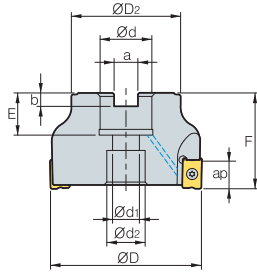


Fig. 1

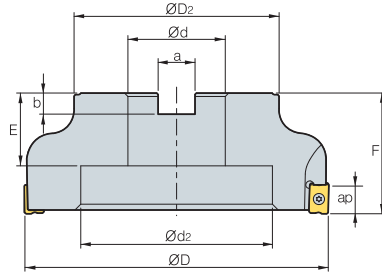


Fig. 2



(mm)

Designation		$\varnothing D$	$\varnothing D_2$	$\varnothing d$	$\varnothing d_1$	$\varnothing d_2$	a	b	E	F	ap		Bolt	Fig.	
RM4PCM	4040HR	3	40	36	16	11	18	8.4	5.6	19	40	14	0.23	SB0825	1
	4050HR	3	50	46	22	11	18	10.4	6.3	20	40	14	0.36	SB1025	1
	4050HR-M	4	50	46	22	11	18	10.4	6.3	20	40	14	0.35	SB1025	1
	4050HR-H	5	50	46	22	11	18	10.4	6.3	20	40	14	0.36	SB1025	1
	4063HR	4	63	49	22	11	18	10.4	6.3	20	40	14	0.56	SB1025	1
RM4PC (RM4PCM)	4063HR-M	6	63	49	22	11	18	10.4	6.3	20	40	14	0.57	SB1025	1
	4080HR	5	80	57	25.4 (27)	14	20	9.5 (12.4)	6.0 (7.0)	25 (23)	50	14	1.18 (1.16)	SB1230	1
	4080HR-M	7	80	57	25.4 (27)	14	20	9.5 (12.4)	6.0 (7.0)	25 (23)	50	14	1.17 (1.14)	SB1230	1
	4080HR-H	8	80	57	25.4 (27)	14	20	9.5 (12.4)	6.0 (7.0)	25 (23)	50	14	1.17 (1.14)	SB1230	1
	4100HR	5	100	67	31.75 (32)	18	26	12.7 (14.4)	8.0 (8.0)	33 (25)	63 (50)	14	2.35 (1.84)	SB1630	1
	4100HR-M	8	100	67	31.75 (32)	18	26	12.7 (14.4)	8.0 (8.0)	33 (25)	63 (50)	14	2.31 (1.82)	SB1630	1
	4100HR-H	9	100	67	31.75 (32)	18	26	12.7 (14.4)	8.0 (8.0)	33 (25)	63 (50)	14	2.31 (1.82)	SB1630	1
	4125HR	7	125	87	38.1 (40)	22	32	15.9 (16.4)	10 (9.0)	35 (30)	63	14	3.87 (3.79)	SB2040	1
	4125HR-M	10	125	87	38.1 (40)	22	32	15.9 (16.4)	10 (9.0)	35 (30)	63	14	3.82 (3.70)	SB2040	1
	4160R	8	160	107	50.8 (40)	-	100	19 (16.4)	11 (9.0)	38 (32)	63	14	5.0 (4.75)	MBA	2
	4160R-M	12	160	107	50.8 (40)	-	100	19 (16.4)	11 (9.0)	38 (32)	63	14	4.97 (4.71)	MBA	2

() Metric size

Available inserts

LNE(X)-MA LNM(E)X-MF LNM(E)X-MM



Designation	Coated										Uncoated	page	Designation	Coated										Uncoated	page								
	CN2500	CN30	NC5330	NCM325	NCM335	NCM535	NCM545	PC2505	PC2010	PC3700				PC6510	PC9530	PC9540	PC5300	PC5400	ST30A	H01	CN2500	CN30	NC5330			NCM325	NCM335	NCM535	NCM545	PC2505	PC2010	PC3700	PC6510
LNE(X) 151004PNR-MF											•	•	•				LNM(X) 151004PNR-MF										•	•	•				
LNE(X) 151004PNR-MM											•	•	•				LNM(X) 151004PNR-MM										•	•	•				
LNE(X) 151008PNR-MF											•	•	•				LNM(X) 151008PNR-MF										•	•	•				
LNE(X) 151008PNR-MM											•	•	•				LNM(X) 151008PNR-MM										•	•	•				
LNE(X) 151016PNR-MF											•	•	•				LNM(X) 151016PNR-MF										•	•	•				
LNE(X) 151016PNR-MM											•	•	•				LNM(X) 151016PNR-MM										•	•	•				

Available arbors

Designation	Available arbors		Designation	Available arbors	
	RM4PC	RM4PCM		RM4PC	RM4PCM
RM4PC(M)	4050HR		RM4PC(M)	4100HR	BT□□-FMA31.75-□□
	4050HR-M			4100HR-M	BT□□-FMA31.75-□□
	4063HR			4125HR	BT□□-FMA38.1-□□
	4063HR-M			4125HR-M	BT□□-FMA38.1-□□
	4080HR	BT□□-FMA25.4-□□		4160R	BT□□-FMA50.8-□□
4080HR-M		4160R-M	BT□□-FMA50.8-□□		

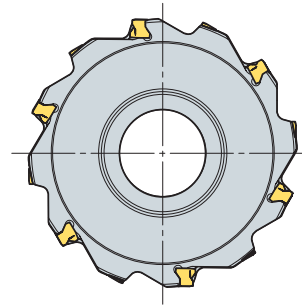
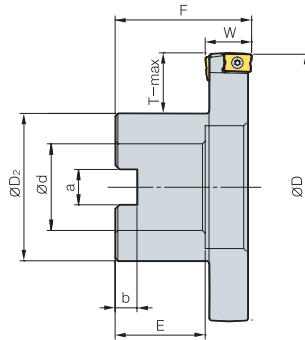
Parts

Specification		
$\varnothing 50\sim\varnothing 160$	FTKA0412B	TW15S

Available inserts E11 Available arbors and bolt E426~E428



RM4PFCB3000



(mm)

Designation		ØD	ØD ₂	Ød	a	b	E	F	W	T-max
RM4PFCB 308015R		80	40	25.4	9.5	6	25	50	15	19
		80	40	25.4	9.5	6	25	50	17	19
310015R		100	54	31.75	12.7	8	32	50	15	22
		100	54	31.75	12.7	8	32	50	17	22
312515R		125	70	38.1	15.9	10	38	60	15	26
		125	70	38.1	15.9	10	38	60	17	26
316015R		160	70	38.1	15.9	10	38	60	15	44
		160	70	38.1	15.9	10	38	60	17	44

Available inserts

LNM(E)X-MM



Designation	Cermet		Coated										Uncoated			page		
	CN2500	CN30	NC5330	NCM325	NCM335	NCM535	NCM545	PC2505	PC2010	PC3700	PC6510	PC9530	PC9540	PC5300	PC5400		ST30A	G10
LNEX 100605PNR-MM 100605PNL-MM										●	●			●	●			
											●			●	●			
LNMX 100605PNR-MM 100605PNL-MM										●	●	●		●	●			
										●	●			●	●			

Available arbors

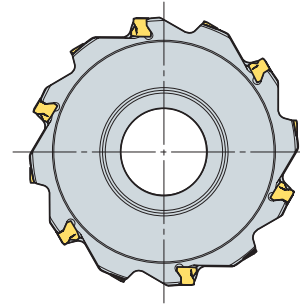
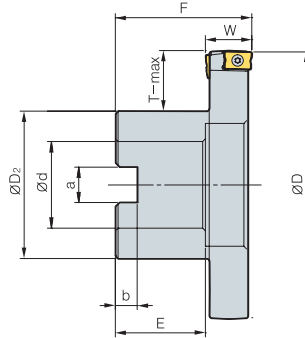
Designation	Available arbors
RM4PFCB 308015R 308017R	BT□□ -FMA25.4-□□
	BT□□ -FMA31.75-□□
310015R 310017R 312515R 312517R 316015R 316017R	BT□□ -FMA38.1-□□

Parts

Specification		
Ø80-Ø160	FTKA0307	TW09S

Available inserts E11 Available arbors and bolt E426~E428

RM4PFCB4000



(mm)

Designation		ØD	ØD ₂	Ød	a	b	E	F	W	T-max	
RM4PFCB	408022R	6	80	40	25.4	9.5	6	25	50	22	19
	408024R	6	80	40	25.4	9.5	6	25	50	24	19
	408026R	6	80	40	25.4	9.5	6	25	50	26	19
	408028R	6	80	40	25.4	9.5	6	25	50	28	19
	410022R	8	100	54	31.75	12.7	8	32	50	22	22
	410024R	8	100	54	31.75	12.7	8	32	50	24	22
	410026R	8	100	54	31.75	12.7	8	32	50	26	22
	410028R	8	100	54	31.75	12.7	8	32	50	28	22
	412522R	10	125	70	38.1	15.9	10	38	60	22	26
	412524R	10	125	70	38.1	15.9	10	38	60	24	26
	412526R	10	125	70	38.1	15.9	10	38	60	26	26
	412528R	10	125	70	38.1	15.9	10	38	60	28	26
	416022R	12	160	70	38.1	15.9	10	38	60	22	44
	416024R	12	160	70	38.1	15.9	10	38	60	24	44
	416026R	12	160	70	38.1	15.9	10	38	60	26	44
	416028R	12	160	70	38.1	15.9	10	38	60	28	44

Available inserts

LNM(E)X-MM



Designation	Cermet		Coated										Uncoated			page			
	CN2500	CN30	NC5330	NCM325	NCM335	NCM535	NCM545	PC2505	PC2010	PC3700	PC6510	PC9530	PC9540	PC5300	PC5400		ST30A	G10	H01
LNEX	151008PNR-MM									●	●			●	●				E11
	151008PNL-MM										●	●		●	●				
LNMX	151008PNR-MM					●				●	●	●		●	●				
	151008PNL-MM													●	●				

Available arbors

Designation	Available arbors	Designation	Available arbors
RM4PFCB	408022R	RM4PFCB	412522R
	408024R		412524R
	408026R		412526R
	408028R		412528R
	410022R		416022R
	410024R		416024R
410026R	416026R	416028R	416028R
410028R			

BT□□ -FMA25.4-□□

BT□□ -FMA31.75-□□

BT□□ -FMA38.1-□□

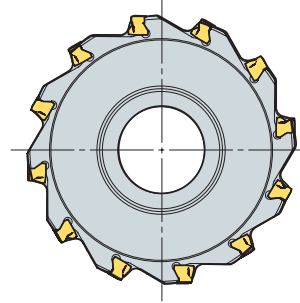
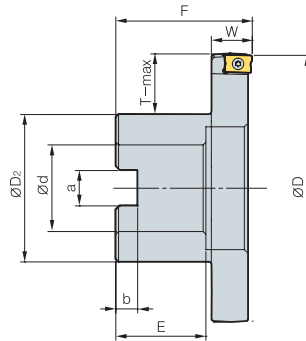
Parts

Specification		
Ø80~Ø160	FTKA0412B	TW15S

Available inserts E11 Available arbors and bolt E426~E428



RM4PHCB3000



(mm)

Designation		ØD	ØD2	Ød	a	b	E	F	W	T-max	
RM4PHCB	308015R	10	80	40	25.4	9.5	6	25	50	15	19
	310015R	12	100	54	31.75	12.7	8	32	50	15	22
	312515R	14	125	70	38.1	15.9	10	38	60	15	26
	316015R	16	160	70	38.1	15.9	10	38	60	15	44

Available inserts

LNEX-MA LNM(E)X-MF LNM(E)X-MM



Designation	Cermet		Coated											Uncoated			page		
	CN2500	CN30	NC5330	NCM325	NCM335	NCM535	NCM545	PC2505	PC2010	PC3700	PC6510	PC9530	PC9540	PC5300	PC5400	ST30A		G10	H01
LNEX	100605PNR-MF										●			●	●				
	100605PNR-MM								●	●				●	●				
	100605PNR-MA																	●	
	100608PNR-MF								●	●				●	●				
	100608PNR-MM										●			●	●				
LNMX	100605PNR-MF										●			●	●				
	100605PNR-MM								●	●	●			●	●				
	100608PNR-MF										●			●	●				
	100608PNR-MM								●					●	●				

Available arbors

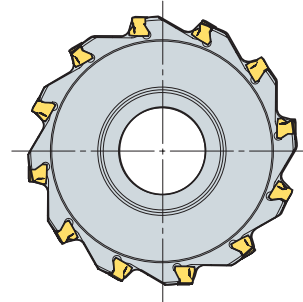
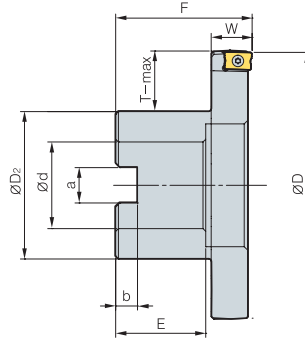
Designation	Available arbors
RM4PHCB 308015R	BT□□-FMA25.4-□□
310015R	BT□□-FMA31.75-□□
312515R	BT□□-FMA38.1-□□
316015R	

Parts

Specification		
Ø80-Ø160	FTKA0307	TW09S

Available inserts E11 Available arbors and bolt E426~E428

RM4PHCB4000



(mm)

Designation		ØD	ØD ₂	Ød	a	b	E	F	W	T-max	
RM4PHCB	408020R	6	80	40	25.4	9.5	6	25	50	20	19
	410020R	8	100	54	31.75	12.7	8	32	50	20	22
	412520R	10	125	70	38.1	15.9	10	38	60	20	26
	416020R	12	160	70	38.1	15.9	10	38	60	20	44

Available inserts

LNEX-MA LNM(E)X-MF LNM(E)X-MM



Designation	Cermet		Coated										Uncoated			page			
	CN2500	CN30	NC5330	NCM325	NCM335	NCM535	NCM545	PC2505	PC2010	PC3700	PC6510	PC9530	PC9540	PC5300	PC5400		ST30A	G10	H01
LNEX	151004PNR-MF										●			●	●				E11
	151004PNR-MM										●			●	●				
	151004PNR-MA																	●	
	151008PNR-MF										●			●	●				
	151008PNR-MM										●	●		●	●				
	151008PNR-MA																	●	
	151016PNR-MF											●			●	●			
	151016PNR-MM											●			●	●			
LNMX	151004PNR-MF									●	●			●	●				
	151004PNR-MM										●			●	●				
	151008PNR-MF						●			●	●			●	●				
	151008PNR-MM						●			●	●	●		●	●				
	151016PNR-MF										●			●	●				
	151016PNR-MM										●			●	●				

Available arbors

Designation	Available arbors
RM4PHCB 408020R	BT□□ -FMA25.4-□□
410020R	BT□□ -FMA31.75-□□
412520R	BT□□ -FMA38.1-□□
416020R	

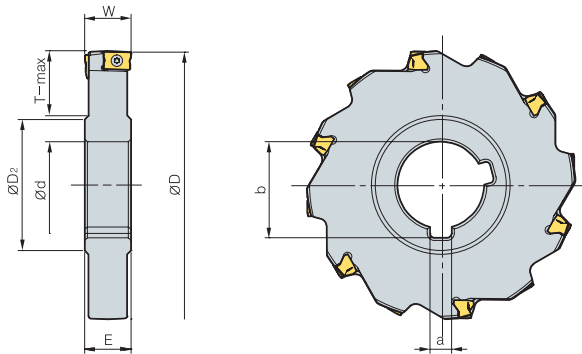
Parts

Specification		
Ø80~Ø160	FTKA0412B	TW15S

Available inserts E11 Available arbors and bolt E426~E428



RM4PFCP3000



(mm)

Designation		ØD	ØD ₂	Ød	a	b	E	W	T-max	
RM4PFCP	308015R	10	80	41.5	25.4	6.35	28	15	15	17
	308017R	10	80	41.5	25.4	6.35	28	17	17	17
	310015R	12	100	48	31.75	7.94	35.2	15	15	24
	310017R	12	100	48	31.75	7.94	35.2	17	17	24
	312515R	14	125	58	38.1	9.53	42.3	15	15	32
	312517R	14	125	58	38.1	9.53	42.3	17	17	32
	316015R	16	160	58	38.1	9.53	42.3	15	15	49
	316017R	16	160	58	38.1	9.53	42.3	17	17	49

Available inserts

LN(E)X-MM



Designation	Cermet		Coated										Uncoated			page		
	CN2500	CN30	NC5300	NCM325	NCM335	NCM535	NCM545	PC2505	PC2010	PC3700	PC6510	PC9530	PC9540	PC5300	PC5400		ST30A	G10
LNEX	100605PNR-MM									●	●			●	●			
	100605PNL-MM										●			●	●			
LNMX	100605PNR-MM									●	●	●		●	●			
	100605PNL-MM									●	●			●	●			

Available arbors

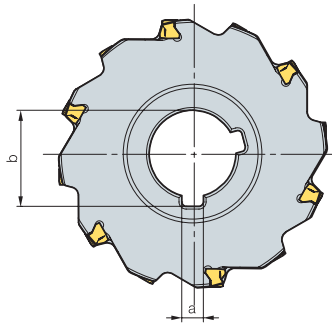
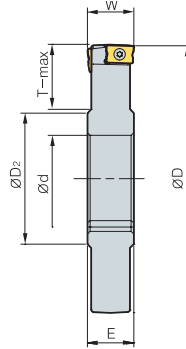
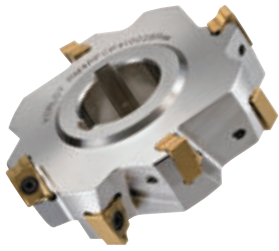
Designation	Available arbors
RM4PFCP	308015R
	308017R
310015R	
310017R	BT□□-SCA31.75-□□
312515R	
312517R	
316015R	BT□□-SCA38.1-□□
316017R	

Parts

Specification		
Ø80~Ø160	FTKA0307	TW09S

Available inserts E11 Available arbors and bolt E426~E428

RM4PFCP4000



(mm)

Designation		ØD	ØD ₂	Ød	a	b	E	W	T-max
RM4PFCP	408022R	6	80	41.5	25.4	6.35	28	22	17
	408024R	6	80	41.5	25.4	6.35	28	24	17
	408026R	6	80	41.5	25.4	6.35	28	26	17
	408028R	6	80	41.5	25.4	6.35	28	28	17
	410022R	8	100	48	31.75	7.94	35.2	22	24
	410024R	8	100	48	31.75	7.94	35.2	24	24
	410026R	8	100	48	31.75	7.94	35.2	26	24
	410028R	8	100	48	31.75	7.94	35.2	28	24
	412522R	10	125	58	38.1	9.53	42.3	22	32
	412524R	10	125	58	38.1	9.53	42.3	24	32
	412526R	10	125	58	38.1	9.53	42.3	26	32
	412528R	10	125	58	38.1	9.53	42.3	28	32
	416022R	12	160	58	38.1	9.53	42.3	22	49
	416024R	12	160	58	38.1	9.53	42.3	24	49
	416026R	12	160	58	38.1	9.53	42.3	26	49
	416028R	12	160	58	38.1	9.53	42.3	28	49

Available inserts

LNM(E)X-MM



Designation	Cermet		Coated											Uncoated			page	
	CN2500	CN30	NC5330	NCM325	NCM335	NCM535	NCM545	PC2505	PC2010	PC3700	PC6510	PC9530	PC9540	PC5300	PC5400	ST30A		G10
LNEX 151008PNR-MM										●	●			●	●			
151008PNL-MM											●			●	●			
LNMX 151008PNR-MM						●				●	●	●		●	●			
151008PNL-MM														●	●			

Available arbors

Designation	Available arbors	Designation	Available arbors
RM4PFCP	408022R	RM4PFCP	412522R
	408024R		412524R
	408026R		412526R
	408028R		412528R
	410022R		416022R
	410024R		416024R
	410026R		416026R
	410028R		416028R

BT□□-SCA25.4-□□

BT□□-SCA31.75-□□

BT□□-SCA38.1-□□

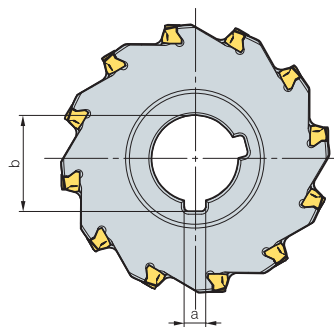
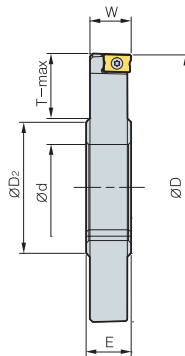
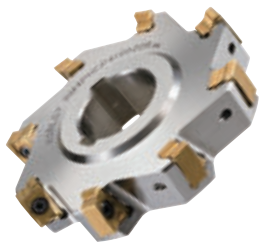
Parts

Specification		
Ø80~Ø160	FTKA0412B	TW15S

Available inserts E11 Available arbors and bolt E426~E428



RM4PHCP3000

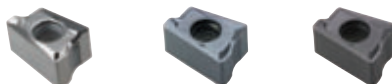


(mm)

Designation		ØD	ØD ₂	Ød	a	b	E	W	T-max	
RM4PHCP	308015R	10	80	41.5	25.4	6.35	28	16.5	15.1	17
	310015R	12	100	48	31.75	7.94	35.2	16.5	15.1	24
	312515R	14	125	58	38.1	9.52	42.3	16.5	15.1	32
	316015R	16	160	58	38.1	9.52	42.3	16.5	15.1	49

Available inserts

LNEX-MA LNM(E)X-MF LNM(E)X-MM



Designation	Cermet		Coated											Uncoated			page	
	CN2500	CN30	NC5330	NCM325	NCM335	NCM535	NCM545	PC2505	PC2010	PC3700	PC6510	PC9530	PC9540	PC5300	PC5400	ST30A		G10
LNEX	100605PNR-MF										●			●	●			
	100605PNR-MM									●	●			●	●			
	100605PNR-MA																	●
	100608PNR-MF									●	●			●	●			
	100608PNR-MM										●			●	●			
LNMX	100605PNR-MF										●			●	●			
	100605PNR-MM									●	●	●		●	●			
	100608PNR-MF										●			●	●			
	100608PNR-MM									●				●	●			

Available arbors

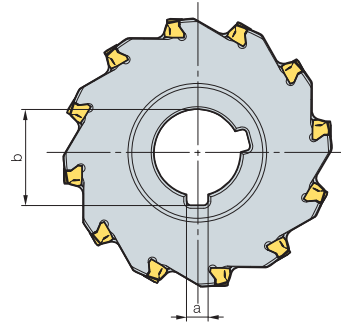
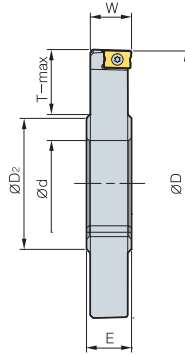
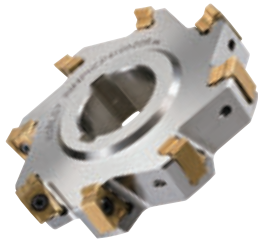
Designation	Available arbors
RM4PHCP 308015R	BT□□ -SCA25.4-□□
310015R	BT□□ -SCA31.75-□□
312515R	BT□□ -SCA38.1-□□
316015R	

Parts

Specification		
Ø80~Ø160	FTKA0307	TW09S

Available inserts E11 Available arbors and bolt E426~E428

RM4PHCP4000



(mm)

Designation		ØD	ØD2	Ød	a	b	E	W	T-max	
RM4PHCP	408020R	6	80	41.5	25.4	6.35	28	22	19.8	17
	410020R	8	100	48	31.75	7.94	35.2	22	19.8	24
	412520R	10	125	58	38.1	9.53	42.3	22	19.8	32
	416020R	12	160	58	38.1	9.53	42.3	22	19.8	49

Available inserts

LNEX-MA LNM(E)X-MF LNM(E)X-MM



Designation	Cermet		Coated												Uncoated			page
	CN2500	CN30	NC5330	NCM325	NCM335	NCM535	NCM545	PC2505	PC2010	PC3700	PC6510	PC9530	PC9540	PC5300	PC5400	ST30A	G10	
LNEX	151004PNR-MF										●			●	●			
	151004PNR-MM										●			●	●			
	151004PNR-MA																	
	151008PNR-MF										●			●	●			
	151008PNR-MM									●	●			●	●			
	151008PNR-MA																	
	151016PNR-MF											●		●	●			
	151016PNR-MM											●		●	●			
LNMX	151004PNR-MF									●	●			●	●			
	151004PNR-MM										●			●	●			
	151008PNR-MF						●			●	●			●	●			
	151008PNR-MM						●			●	●			●	●			
	151016PNR-MF										●			●	●			
	151016PNR-MM										●			●	●			

E11

Available arbors

Designation	Available arbors
RM4PHCP 408020R	BT□□ -SCA25.4-□□
410020R	BT□□ -SCA31.75-□□
412520R	BT□□ -SCA38.1-□□
416020R	

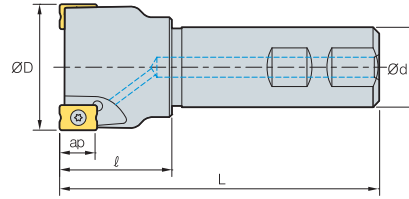
Parts

Specification		
Ø80~Ø160	FTKA0412B	TW15S

Available inserts E11 Available arbors and bolt E426~E428



RM4PS3000



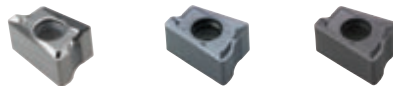
AA
90°
• AR: -6°
• RR: -39°~-16°

(mm)

Designation		ØD	Ød	l	L	ap	
RM4PS	3014HR-S16	1	14	16	23	90	0.11
	3016HR-S16	1	16	16	25	90	0.11
	3018HR-S16	2	18	16	23	90	0.12
	3020HR-S20	2	20	20	30	100	0.21
	3020HR-S20M	3	20	20	30	100	0.21
	3025HR-S25	2	25	25	35	115	0.38
	3025HR-S25M	3	25	25	35	115	0.38
	3032HR-S32	3	32	32	40	125	0.69
	3032HR-S32M	4	32	32	40	125	0.7
	3040HR-S32	4	40	32	42	130	0.86
	3040HR-S32M	5	40	32	42	130	0.85
	3040HR-S40	4	40	40	42	130	1.17
	3040HR-S40M	5	40	40	42	130	1.17
	3040HR-S42	4	40	42	42	130	1.26
	3040HR-S42M	5	40	42	42	130	1.25
	3050HR-S32	5	50	32	45	135	1.06
	3050HR-S32M	7	50	32	45	135	1.05
	3050HR-S40	5	50	40	45	135	1.38
	3050HR-S40M	7	50	40	45	135	1.37
	3050HR-S42	5	50	42	45	135	1.48
3050HR-S42M	7	50	42	45	135	1.48	

Available inserts

LNEX-MA LNM(E)X-MF LNM(E)X-MM



Designation	Cermet		Coated										Uncoated			page		
	CN2500	CN30	NC5330	NCM325	NCM335	NCM635	NCM645	PC2505	PC2010	PC3700	PC6510	PC9530	PC9540	PC5300	PC5400		ST30A	G10
LNEX	100605PNR-MF										●			●	●			
	100605PNR-MM									●	●			●	●			
	100605PNR-MA																	●
	100605PNL-MM									●	●			●	●			
	100608PNR-MF										●			●	●			
LNMX	100608PNR-MM										●			●	●			
	100605PNR-MF									●	●	●		●	●			
	100605PNR-MM										●			●	●			
	100608PNR-MF									●				●	●			
	100608PNR-MM										●	●		●	●			

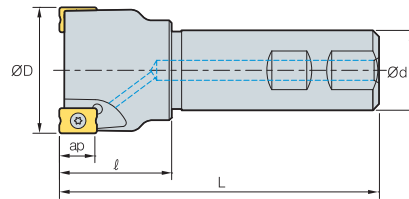
Parts

Specification		
Ø14~Ø50	FTKA0307	TW09S

Available inserts E11



RM4PS4000



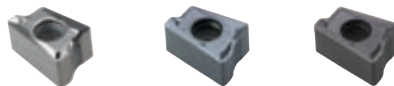
• AR: -6°
• RR: -24°~14°

(mm)

Designation		ØD	Ød	ℓ	L	ap	
RM4PS	4032HR-S32	2	32	32	40	125	0.68
	4032HR-S32M	3	32	32	40	125	0.69
	4040HR-S32	3	40	32	42	125	0.83
	4040HR-S32M	4	40	32	42	125	0.83
	4040HR-S40	3	40	40	42	125	1.14
	4040HR-S42	3	40	42	42	125	1.23
	4050HR-S32	3	50	32	45	125	1.02
	4050HR-S32M	4	50	32	45	125	1.02
	4050HR-S40	3	50	40	45	125	1.35
	4050HR-S40M	4	50	40	45	125	1.34
	4050HR-S42	3	50	42	45	125	1.45
	4050HR-S42M	4	50	42	45	125	1.45
	4063HR-S32	4	63	32	45	125	1.25
	4063HR-S32M	6	63	32	45	125	1.24
	4063HR-S40	4	63	40	45	125	1.62
	4063HR-S40M	6	63	40	45	125	1.61
4063HR-S42	4	63	42	45	125	1.71	
4063HR-S42M	6	63	42	45	125	1.7	

Available inserts

LNEX-MA LNM(E)X-MF LNM(E)X-MM



Designation	Cermet		Coated										Uncoated			page			
	CN2500	CN30	NC5330	NCM325	NCM335	NCM535	NCM545	PC2505	PC2010	PC3700	PC6510	PC9530	PC9540	PC5300	PC5400		ST30A	G10	H01
LNEX	151004PNR-MF										●			●	●				
	151004PNR-MM										●			●	●				
	151004PNR-MA																	●	
	151008PNR-MF										●			●	●				
	151008PNR-MM									●	●			●	●				
	151008PNR-MA																		●
	151016PNR-MF										●			●	●				
	151016PNR-MM										●			●	●				
LNMX	151004PNR-MF									●	●			●	●				
	151004PNR-MM										●			●	●				
	151008PNR-MF						●			●	●			●	●				
	151008PNR-MM						●			●	●	●		●	●				
	151016PNR-MF									●	●	●		●	●				
	151016PNR-MM										●			●	●				

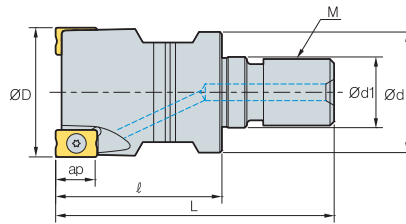
Parts

Specification		
Ø32-Ø63	FTKA0412B	TW15S

Available inserts E11



RM4PM3000



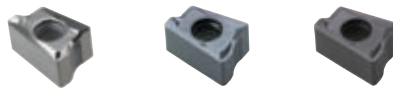
AA
90°
• AR: -6°
• RR: -39°~-16°

(mm)

Designation		ØD	Ød	Ød1	ℓ	L	M	ap	
RM4PM 3014HR-M06	1	14	12	6.5	25	40	M06	9.0	0.02
3016HR-M08	1	16	14.5	8.5	25	42	M08	9.0	0.02
3018HR-M08	2	18	14.5	8.5	25	42	M08	9.0	0.03
3020HR-M10	2	20	18	10.5	30	51	M10	9.0	0.06
3025HR-M12	2	25	23	12.5	35	59	M12	9.0	0.11
3032HR-M16	3	32	29	17	40	67	M16	9.0	0.21
3040HR-M16	4	40	29	17	40	67	M16	9.0	0.26
3050HR-M16	5	50	30	17	45	72	M16	9.0	0.41

Available inserts

LNEX-MA LNM(E)X-MF LNM(E)X-MM



Designation	Cermet		Coated										Uncoated			page		
	CN2500	CN30	NC5330	NCM325	NCM335	NCM535	NCM545	PC2505	PC2010	PC3700	PC6510	PC9530	PC9540	PC5300	PC5400		ST30A	G10
LNEX 100605PNR-MF											●			●	●			
100605PNR-MM										●	●			●	●			
100605PNR-MA																		●
LNEX 100608PNR-MF										●	●			●	●			
100608PNR-MM											●			●	●			
LNMX 100605PNR-MF											●			●	●			
100605PNR-MM										●	●	●		●	●			
100608PNR-MF											●			●	●			
100608PNR-MM										●				●	●			

Available adaptor

Designation	Available adaptor
RM4PM 3014HR-M06	MAT-M06
3016HR-M08	MAT-M08
3018HR-M08	
3020HR-M10	
3025HR-M12	MAT-M12
3032HR-M16	MAT-M16
3040HR-M16	
3050HR-M16	

Designation : RM4PM3032HR-M16
Modular head threading measure size (M16)

||

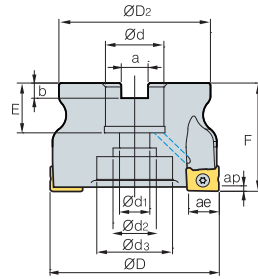
Adaptor spec.: MAT-M16-035-S32S
Adaptor threading measure (M16)

Parts

Specification		
Ø14~Ø50	FTKA0307	TW09S

Available inserts E11 Available adaptor E401~E402

RM4ZC(M)3000/4000



AA
90°
• AR: -11°
• RR: -12°~10°

(mm)

Designation	齿数	ØD	ØD2	Ød	Ød1	Ød2	Ød3	a	b	E	F	ap	ae	ρ _{kg}	
RM4ZCM	3040HR	4	40	37	16	9	14	-	8.4	5.6	19	40	1.5	9.0	0.21
	3050HR	5	50	47	22	11	18	-	10.4	6.3	20	40	1.5	9.0	0.33
	3052HR	5	52	48	22	11	18	-	10.4	6.3	20	40	1.5	9.0	0.37
	4063HR	5	63	58	22	11	18	-	10.4	6.3	20	40	2.5	14.0	0.56
RM4ZC (RM4ZCM)	4066HR	5	66	61	25.4 (27)	14	20	-	9.5 (12.4)	6 (7)	25	50	2.5	14.0	0.74
	4080HR	6	80	70	25.4 (27)	14	20	35	9.5 (12.4)	6 (7)	25 (23)	50	2.5	14.0	1.09
	4100HR	7	100	80	31.75 (32)	18	26	42	12.7 (14.4)	8 (8)	25 (33)	63 (50)	2.5	14.0	1.71

()Metric size

Available inserts

LNM(E)X-MM



Designation	Cermet		Coated										Uncoated			page			
	CN2500	CN30	NC5330	NCM325	NCM335	NCM535	NCM545	PC2505	PC2010	PC3700	PC6510	PC9530	PC9540	PC5300	PC5400		ST30A	G10	H01
3000 type	LNEX	100605PNL-MM									●			●	●				E11
	LNMX	100605PNL-MM								●	●			●	●				
4000 type	LNEX	151008PNL-MM									●			●	●				
	LNMX	151008PNL-MM												●	●				

Available arbors

Designation	Available arbors	
	RM4ZC	RM4ZCM
RM4ZCM	3040HR	BT□□-FMC16-□□ BT□□-SCA16-□□
		3050HR 3052HR
	4063HR	BT□□-FMC22-□□
RM4ZCM RM4ZC(M)	4066HR	BT□□-FMA25.4-□□
	4080HR	
	4100HR	BT□□-FMA31.75-□□ BT□□-SCA31.75-□□

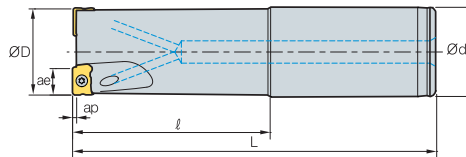
Parts

Specification	Screw	Wrench
Ø40~Ø52 (3000 type)	FTKA0307	TW09S
Ø63~Ø100 (4000 type)	FTKA0412B	TW15S

Available inserts E11 Available arbors and bolt E426~E428

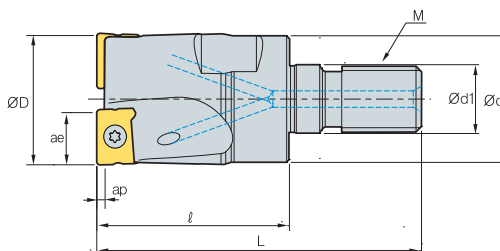


RM4ZS3000



Designation		ØD	Ød	ℓ	L	ap	ae	
RM4ZS	3025HR-L25	2	25	25	120	200	1.5	0.62
	3032HR-L32	3	32	32	120	210	1.5	1.13
	3040HR-L32	4	40	32	120	250	1.5	1.53

RM4ZM3000



Designation		ØD	Ød	Ød1	ℓ	L	M	ap	ae	
RM4ZM	3025HR-M12	2	25	23	12.5	35	M12	1.5	9.0	0.11
	3032HR-M16	3	32	29	17	40	M16	1.5	9.0	0.21
	3040HR-M16	4	40	29	17	40	M16	1.5	9.0	0.28

Available inserts

LNM(E)X-MM



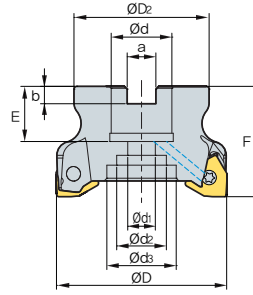
Designation	Cermet		Coated								Uncoated			page				
	CN2500	CN30	NC5330	NCM325	NCM335	NCM335	NCM645	PC2505	PC2010	PC3700	PC6510	PC9530	PC9540		PC5300	PC5400	ST30A	G10
LNEX 100605PNL-MM											●			●	●			
LNMX 100605PNL-MM										●	●			●	●			

Parts

Specification		
Ø25~Ø40	FTKA0307	TW09S

Available inserts E11

RM6PCM-WN04 new



AA
90°
• AR: -6°
• RR: -14°~11°

(mm)

Designation	ØD	ØD2	Ød	Ød1	Ød2	Ød3	a	b	E	F	ap		Available screw		
RM6PCM	040R-16-6-WN04	6	40	35	16	9	14	-	8.4	5.6	19	40	4.3	0.19	ETNA02506
	040R-16-7-WN04	7	40	35	16	9	14	-	8.4	5.6	19	40	4.3	0.19	ETNA02506
	050R-22-8-WN04	8	50	42	22	11	18	-	10.4	6.3	20	40	4.3	0.28	ETNA02506
	050R-22-9-WN04	9	50	42	22	11	18	-	10.4	6.3	20	40	4.3	0.28	ETNA02506
	063R-22-10-WN04	10	63	49	22	11	18	-	10.4	6.3	20	40	4.3	0.47	ETNA02506
	063R-22-11-WN04	11	63	49	22	11	18	-	10.4	6.3	20	40	4.3	0.47	ETNA02506

Available inserts

WNGX-MA WNGX-ML WNGX-MM



Designation	Cermet		Coated										Uncoated			page			
	CN2500	CN30	NC5330	NCM325	NCM335	NCM535	NCM545	PC2505	PC2010	PC3700	PC6510	PC9530	PC9540	PC5300	PC5400		ST30A	G10	H01
WNGX	040304PNFR-MA																		●
	040308PNFR-MA																		●
	040312PNFR-MA																		●
	040316PNFR-MA																		●
	040304PNER-ML										●		●	●	●				
	040308PNER-ML														●	●			
	040312PNER-ML														●				
	040316PNER-ML														●				
	040304PNSR-MM										●				●	●			
	040308PNSR-MM														●	●			
	040312PNSR-MM														●				
	040316PNSR-MM														●				

Available arbors

Designation	NC arbors	
RM6PCM	040R-16-6-WN04	BT□□-FMC16-□□
	040R-16-7-WN04	
	050R-22-8-WN04	
	050R-22-9-WN04	BT□□-FMC22-□□
	063R-22-10-WN04	
	063R-22-11-WN04	

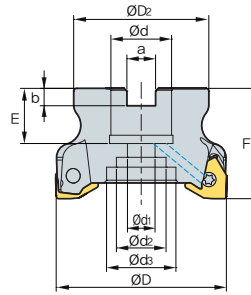
Parts

Specification		
Ø40~Ø63	ETNA02506	TW07S

Available inserts E30 Available arbors and bolt E426-E428



RM6PC(M)-WN08 new



(mm)

Designation	⊙	ØD	ØD2	Ød	Ød1	Ød2	Ød3	a	b	E	F	ap		Available screw	
RM6PCM	050R-22-4-WN08	4	50	42	22	11	18	-	10.4	6.3	20	40	8.2	0.28	FTNA0513
	050R-22-5-WN08	5	50	42	22	11	18	-	10.4	6.3	20	40	8.2	0.27	FTNA0511
	063R-22-5-WN08	5	63	49	22	11	18	-	10.4	6.3	20	40	8.2	0.45	FTNA0513
	063R-22-6-WN08	6	63	49	22	11	18	-	10.4	6.3	20	40	8.2	0.45	FTNA0513
	080R-27-7-WN08	7	80	57	27	14	20	35	12.4	7	23	50	8.2	0.90	FTNA0513
	080R-27-9-WN08	9	80	57	27	14	20	35	12.4	7	23	50	8.2	0.89	FTNA0511
	100R-32-8-WN08	8	100	67	32	18	26	42	14.4	8	25	50	8.2	1.47	FTNA0513
	100R-32-11-WN08	11	100	67	32	18	26	42	14.4	8	25	50	8.2	1.45	FTNA0511
	125R-40-11-WN08	11	125	90	40	22	32	52	16.4	9	29	63	8.2	2.94	FTNA0513
	125R-40-14-WN08	14	125	90	40	22	32	52	16.4	9	29	63	8.2	2.91	FTNA0511
RM6PC	080R-25.4-7-WN08	7	80	57	25.4	14	20	35	9.5	6	25	50	8.2	0.91	FTNA0513
	080R-25.4-9-WN08	9	80	57	25.4	14	20	35	9.5	6	25	50	8.2	0.91	FTNA0511
	100R-31.75-8-WN08	8	100	67	31.75	18	26	42	12.7	8	32	63	8.2	1.69	FTNA0513
	100R-31.75-11-WN08	11	100	67	31.75	18	26	42	12.7	8	32	63	8.2	1.73	FTNA0511
	125R-38.1-11-WN08	11	125	90	38.1	22	32	52	15.9	10	35	63	8.2	1.98	FTNA0513
	125R-38.1-14-WN08	14	125	90	38.1	22	32	52	15.9	10	35	63	8.2	2.90	FTNA0511

Available inserts

WNGX-MA WNGX-ML WNGX-MM



Designation	Cermet									page	Designation	Cermet									page																
	CN2500	CN30	NC5330	NCM325	NCM335	NCM335	NCM545	PC2505	PC2010			PC3700	PC6510	PC9530	PC9540	PC5300	PC5400	ST30A	H01	Designation		CN2500	CN30	NC5330	NCM325	NCM335	NCM335	NCM545	PC2505	PC2010	PC3700	PC6510	PC9530	PC9540	PC5300	PC5400	ST30A
WNGX 080604PNFR-MA	080604PNFR-MA																		WNGX 080616PNER-ML	080616PNER-ML																	
	080608PNFR-MA																			080620PNER-ML																	
	080612PNFR-MA																			080604PNSR-MM																	
	080616PNFR-MA																			080608PNSR-MM																	
	080620PNFR-MA																			080612PNSR-MM																	
	080604PNER-ML																			080616PNSR-MM																	
	080608PNER-ML																			080620PNSR-MM																	
	080612PNER-ML																																				

Available arbors

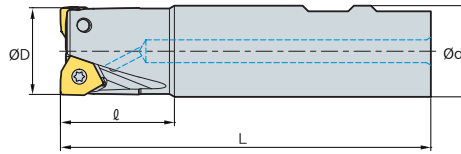
Designation	NC arbors	Designation	NC arbors
RM6PC	080R-25.4-7-WN08	RM6PCM	063R-22-5-WN08
	080R-25.4-9-WN08		063R-22-6-WN08
	100R-31.75-8-WN08		080R-27-7-WN08
	100R-31.75-11-WN08		080R-27-9-WN08
	125R-38.1-11-WN08		100R-32-8-WN08
	125R-38.1-14-WN08		100R-32-11-WN08
RM6PCM	050R-22-4-WN08	RM6PCM	125R-40-11-WN08
	050R-22-5-WN08		125R-40-14-WN08

Parts

Specification		
Ø50-Ø125	FTNA0511/FTNA0513	TW20-100

Available inserts E30 Available arbors and bolt E426~E428

RM6PS-WN04 new

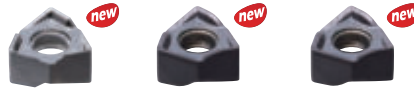


(mm)

Designation		ØD	Ød	ℓ	L	ap		Available screw
RM6PS	020R-2W20-110-WN04	2	20	20	35	110	0.22	ETNA02506
	020R-3W20-110-WN04	3	20	20	35	110	0.22	ETNA02506
	025R-3W25-110-WN04	3	25	25	35	110	0.36	ETNA02506
	025R-4W25-110-WN04	4	25	25	35	110	0.35	ETNA02506
	032R-5W32-110-WN04	5	32	32	35	110	0.60	ETNA02506
	032R-6W32-110-WN04	6	32	32	35	110	0.60	ETNA02506

Available inserts

WNGX-MA WNGX-ML WNGX-MM



Designation	Cermet		Coated										Uncoated			page		
	CN2500	CN30	NC5330	NCM535	NCM545	PC2505	PC2010	PC3700	PC6510	PC9530	PC9540	PC5300	PC5400	ST30A	G10		H01	
WNGX	040304PNFR-MA																●	
	040308PNFR-MA																	●
	040312PNFR-MA																	●
	040316PNFR-MA																	●
	040304PNER-ML								●		●	●	●					
	040308PNER-ML											●	●					
	040312PNER-ML											●	●					
	040316PNER-ML											●	●					
	040304PNSR-MM								●			●	●					
	040308PNSR-MM											●	●					
	040312PNSR-MM											●	●					
	040316PNSR-MM											●	●					

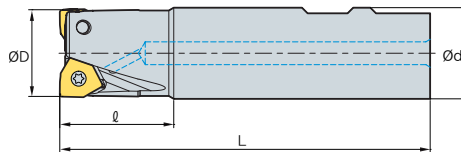
Parts

Specification		
Ø20~Ø32	ETNA02506	TW07S

Available inserts E30



RM6PS-WN08 new



AA
90°
• AR: -6°
• RR: -20°~-14°

(mm)

Designation		ØD	Ød	l	L	ap		Available screw	
RM6PS	032R-2W32-120-WN08	2	32	32	40	120	8.2	0.65	FTNA0513
	040R-3W32-120-WN08	3	40	32	40	120	8.2	0.69	FTNA0513
	040R-4W32-120-WN08	4	40	32	40	120	8.2	0.69	FTNA0513
	050R-4W32-120-WN08	4	50	32	40	120	8.2	0.76	FTNA0513
	050R-5W32-120-WN08	5	50	32	40	120	8.2	0.76	FTNA0513

Available inserts

WNGX-MA WNGX-ML WNGX-MM



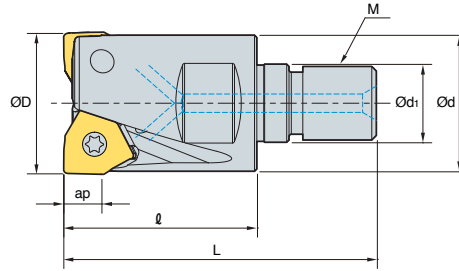
Designation	Cermet		Coated												Uncoated			page	
	CN2500	CN30	NC5330	NCM325	NCM335	NCM535	NCM545	PC2505	PC2010	PC3700	PC6510	PC9530	PC9540	PC5300	PC5400	ST30A	G10		H01
WNGX	080604PNFR-MA																		●
	080608PNFR-MA																		●
	080612PNFR-MA																		●
	080616PNFR-MA																		●
	080620PNFR-MA																		●
	080604PNER-ML										●		●	●	●				
	080608PNER-ML						●				●	●	●	●	●				
	080612PNER-ML														●				
	080616PNER-ML														●				
	080620PNER-ML														●				
	080604PNSR-MM										●				●	●			
	080608PNSR-MM						●				●	●	●	●	●	●			
	080612PNSR-MM														●				
	080616PNSR-MM														●				
	080620PNSR-MM														●				

Parts

Specification		
Ø32~Ø50	FTNA0513	TW20-100

Available inserts E30

RM6PM-WN04 new



(mm)

Designation	Flutes	ØD	Ød	Ød1	ℓ	L	M	ap	Weight
RM6PM 020R-2-M10-WN04	2	20	18	10.5	30	50	10	4.3	0.06
020R-3-M10-WN04	3	20	18	10.5	30	50	10	4.3	0.06
025R-4-M12-WN04	4	25	23	12.5	30	53	12	4.3	0.1
025R-5-M12-WN04	5	25	23	12.5	30	53	12	4.3	0.09
032R-5-M16-WN04	5	32	29	17	40	66	16	4.3	0.25
032R-6-M16-WN04	6	32	29	17	40	66	16	4.3	0.24

Available inserts



Designation	Coated										Uncoated	page	Designation	Coated										Uncoated	page								
	CN2500	CN30	NC5330	NCM325	NCM335	NCM535	NCM545	PC2505	PC3700	PC6510				PC9530	PC9540	PC5300	PC5400	ST30A	H01	CN2500	CN30	NC5330	NCM325			NCM335	NCM535	NCM545	PC2505	PC3700	PC6510	PC9530	PC9540
WNGX 040304PNFR-MA																•	WNGX 080604PNFR-MA																•
040308PNFR-MA																•	080608PNFR-MA																•
040312PNFR-MA																•	080612PNFR-MA																•
040316PNFR-MA																•	080616PNFR-MA																•
040304PNER-ML									•	•	•	•	•	•	•		080620PNFR-MA																•
040308PNER-ML																•	080604PNER-ML																•
040312PNER-ML																•	080608PNER-ML																•
040316PNER-ML																•	080612PNER-ML																•
040304PNSR-MM																•	080616PNER-ML																•
040308PNSR-MM																•	080620PNER-ML																•
040312PNSR-MM																•	080604PNSR-MM																•
040316PNSR-MM																•	080608PNSR-MM																•
																•	080612PNSR-MM																•
																•	080616PNSR-MM																•
																•	080620PNSR-MM																•

Available adaptor

Designation	Available adaptor
RM6PM 020R-2-M10-WN04	MAT-M10
020R-3-M10-WN04	MAT-M10
025R-4-M12-WN04	MAT-M12
025R-5-M12-WN04	MAT-M12
032R-5-M16-WN04	MAT-M16
032R-6-M16-WN04	MAT-M16

Designation : RM6PM032R-5-M16-WN04
 Modular head threading measure size (M16)

II

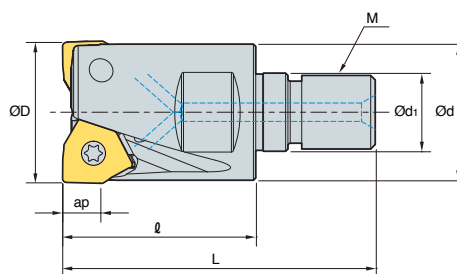
Adaptor spec.: MAT-M16-035-S32S
 Adaptor threading measure (M16)

Parts

Specification	Screw	Wrench
Ø20-Ø32	ETNA02506	TW07S



Available inserts E30 Available adaptor E401~E402



RM6PM-WN08 AA
90°

- AR: -6°
- RR: -9°~-6°

(mm)

Designation		ØD	Ød	Ød1	ℓ	L	M	ap	
RM6PM 032R-2-M16-WN08	2	32	29	17	43	69	16	8.2	0.22
040R-3-M16-WN08	3	40	29	17	43	69	16	8.2	0.31
040R-4-M16-WN08	4	40	29	17	43	69	16	8.2	0.30

 Available inserts

WNGX-MA

WNGX-ML

WNGX-MM



Designation	Cermet									page	Designation	Cermet									page																	
	CN2500	CN30	NC5330	NCM325	NCM335	NCM335	NCM545	PC2505	PC2010			PC3700	PC6510	PC9530	PC9540	PC5300	PC5400	ST30A	H01	CN2500		CN30	NC5330	NCM325	NCM335	NCM335	NCM545	PC2505	PC2010	PC3700	PC6510	PC9530	PC9540	PC5300	PC5400	ST30A	H01	
WNGX 040304PNFR-MA											●	WNGX 080604PNFR-MA																								●		
040308PNFR-MA											●	080608PNFR-MA																								●		
040312PNFR-MA											●	080612PNFR-MA																								●		
040316PNFR-MA											●	080616PNFR-MA																								●		
040304PNER-ML									●	●	●	●	080620PNFR-MA																							●		
040308PNER-ML											●	●	080604PNER-ML														●		●	●							●	
040312PNER-ML											●	●	080608PNER-ML															●	●	●							●	
040316PNER-ML											●	●	080612PNER-ML																●								●	
040304PNSR-MM									●	●	●	●	080616PNER-ML																●								●	
040308PNSR-MM											●	●	080620PNER-ML																	●							●	
040312PNSR-MM											●	●	080604PNSR-MM															●		●	●						●	
040316PNSR-MM											●	●	080608PNSR-MM														●		●	●							●	
											●	●	080612PNSR-MM																	●							●	
											●	●	080616PNSR-MM																	●							●	
											●	●	080620PNSR-MM																	●								●

 Available adaptor

Designation	Available adaptor
RM6PM 032R-2-M16-WN08	MAT-M16
040R-3-M16-WN08	MAT-M16
040R-4-M16-WN08	MAT-M16

Designation : RM6PM032R-5-M16-WN04
Modular head threading measure size (M16)

II

Adaptor spec.: MAT-M16-035-S32S
Adaptor threading measure (M16)

 Parts

Specification	 Screw	 Wrench
Ø32-Ø40	FTNA0513	TW20-100

 Available inserts E30  Available adaptor E401~E402



Milling

E

125

RM8AC(M)4000

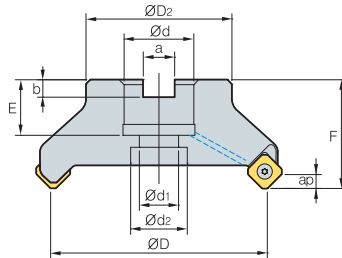


Fig. 1

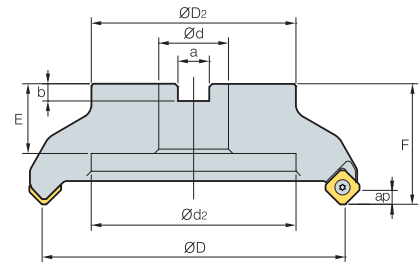
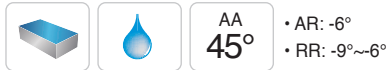


Fig. 2



(mm)

Designation	ØD	ØD2	Ød	Ød1	Ød2	a	b	E	F	ap	kg	Fig.	
RM8ACM													
4050HR-M	4	50	49	22	11	18	10.4	6.3	20	40	6.0	0.5	1
4050HR-H	6	50	49	22	11	18	10.4	6.3	20	40	6.0	0.5	1
4063HR-M	6	63	49	22	11	18	10.4	6.3	20	40	6.0	0.7	1
4063HR-H	8	63	49	22	11	18	10.4	6.3	20	40	6.0	0.7	1
RM8AC (RM8ACM)													
4080HR	5	80	57	25.4 (27)	14	20	9.5 (12.4)	6(7)	25 (23)	50	6.0	1.2	1
4080HR-M	7	80	57	25.4 (27)	14	20	9.5 (12.4)	6(7)	25 (23)	50	6.0	1.2	1
4080HR-H	10	80	57	25.4 (27)	14	20	9.5 (12.4)	6(7)	25 (23)	50	6.0	1.3	1
4100HR	6	100	67	31.75 (32)	18	26	12.7 (14.4)	8	33 (25.5)	63 (50)	6.0	1.7	1
4100HR-M	8	100	67	31.75 (32)	18	26	12.7 (14.4)	8	33 (25.5)	63 (50)	6.0	1.7	1
4100HR-H	12	100	67	31.75 (32)	18	26	12.7 (14.4)	8	33 (25.5)	63 (50)	6.0	1.7	1
4125HR	8	125	87	38.1 (40)	22	32	15.9 (16.4)	10(9)	36 (30)	63	6.0	3.6	1
4125HR-M	10	125	87	38.1 (40)	22	32	15.9 (16.4)	10(9)	36 (30)	63	6.0	3.6	1
4125HR-H	16	125	87	38.1 (40)	22	32	15.9 (16.4)	10(9)	36 (30)	63	6.0	3.7	1
4160R	10	160	107	50.8 (40)	-	107	19 (16.4)	11(9)	38 (32)	63	6.0	4.8	2
4160R-M	12	160	107	50.8 (40)	-	107	19 (16.4)	11(9)	38 (32)	63	6.0	5.3	2
4160R-H	20	160	107	50.8 (40)	-	107	19 (16.4)	11(9)	38 (32)	63	6.0	5.4	2
4200R-M	14	200	130	47.625 (60)	-	135	25.4 (25.7)	14	38 (32)	63	6.0	7.1	2
4200R-H	24	200	130	47.625 (60)	-	135	25.4 (25.7)	14	38 (32)	63	6.0	7.1	2
4250R-M	16	250	180	47.625 (60)	-	180	25.4 (25.7)	14	38 (32)	63	6.0	11.9	2
4250R-H	30	250	180	47.625 (60)	-	180	25.4 (25.7)	14	38 (32)	63	6.0	12.0	2
4315R	18	315	240	47.625 (60)	-	238	25.4 (25.7)	14	38	63	6.0	18.8 (18.6)	2
4315R-M	20	315	240	47.625 (60)	-	238	25.4 (25.7)	14	38	63	6.0	18.8 (18.6)	2
4400R-M	28	400	260	47.625 (60)	-	238	25.4 (25.7)	14	38	80	6.0	37.7 (37.4)	2

() Metric size

Available inserts

SNM(E)X-MF SNEX-ML SNM(E)X-MM SNEX-MA SNEX-W



Designation	Cermet		Coated										Uncoated		page		
	CN2500	CN30	NC5330	NCM325	NCM335	NCM635	NCM645	PC2505	PC2010	PC3700	PC6510	PC9540	PC5300	PC5400		ST30A	H01
SNEX																	
1206ANN-MF																	
1206ANN-ML																	
1206ANN-MM																	E24
1206ANN-MA																	E25
1206ANN-W																	E26
SNMX																	
1206ANN-MF																	
1206ANN-MM																	

Available arbors

Designation	Available arbors	
	RM8AC	RM8ACM
RM8ACM		
4050HR-□	-	BT□□-FMC22-□□
4063HR-□		
RM8AC (RM8ACM)		
4080HR-□	BT□□-FMA25.4-□□	BT□□-FMC27-□□
4100HR-□	BT□□-FMA31.75-□□	BT□□-FMC32-□□
4125HR-□	BT□□-FMA38.1-□□	BT□□-FMB40-□□
4160R-□	BT□□-FMA50.8-□□	BT□□-FMC40-□□
4200R-□		
4250R-□		
4315R-□	BT□□-FMA47.625-□□	BT□□-FMB60-□□
4400R-□		

Parts

Specification	Screw	Wrench
Ø50~Ø400	FTKA0410	TW15S

Available inserts E24~E26 Available arbors and bolt E426~E428



RMH8AC(M)4000

Shim type

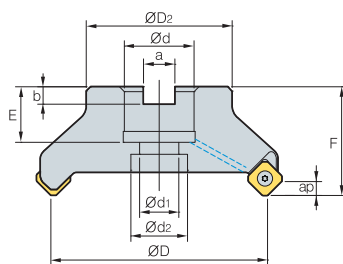


Fig. 1

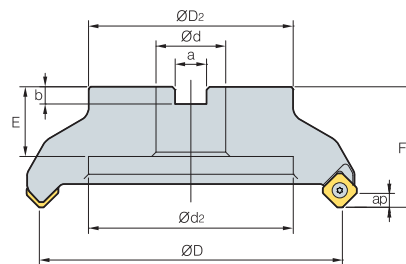


Fig. 2



AA
45°

- AR: -6°
- RR: -9°~ -6°

(mm)

Designation	ØD	ØD2	Ød	Ød1	Ød2	a	b	E	F	ap	kg	Fig.
RMH8AC												
(RMH8ACM)												
4080HR-M	7	80	57	25.4 (27)	14	20	9.5 (12.4)	6 (7)	25 (23)	50	6.0	1
4100HR-M	8	100	67	31.75 (32)	18	26	12.7 (14.4)	8	33 (25.5)	63 (50)	6.0	1
4125HR-M	10	125	87	38.1 (40)	22	32	15.9 (16.4)	10 (9)	36 (30)	63	6.0	1
4160R-M	12	160	107	50.8 (50)	-	107	19 (16.4)	11 (9)	38 (32)	63	6.0	2
4200R-M	14	200	130	47.625 (60)	-	135	25.4 (25.7)	14	38 (32)	63	6.0	2
4250R-M	16	250	180	47.625 (60)	-	180	25.4 (25.7)	14	38 (32)	63	6.0	2
4315R-M	20	315	240	47.625 (60)	-	238	25.4 (25.7)	14	38	63	6.0	2
4400R-M	26	400	260	47.625 (60)	-	238	25.4 (25.7)	14	38	80	6.0	2

() Metric size

Available inserts

SNM(E)X-MF

SNEX-ML

SNM(E)X-MM

SNEX-MA

SNEX-W



Designation	Cermet		Coated										Uncoated			page			
	CN2500	CN30	NC5330	NCM325	NCM335	NCM635	NCM645	PC2505	PC2010	PC3700	PC6510	PC9530	PC9540	PC5300	PC5400		ST30A	G10	H01
SNEX	1206ANN-MF									●	●			●	●				E24 E25 E26
	1206ANN-ML													●	●				
	1206ANN-MM									●	●	●		●	●				
	1206ANN-MA																	●	
	1206ANN-W									●	●			●					
SNMX	1206ANN-MF					●				●	●		●	●	●				
	1206ANN-MM			●		●					●	●		●	●				

Available arbors

Designation	Available arbors		
	RMH8AC	RMH8ACM	
RMH8AC	4080HR-□	BT□□-FMA25.4-□□	BT□□-FMC27-□□
(RMH8ACM)	4100HR-□	BT□□-FMA31.75-□□	BT□□-FMC32-□□
	4125HR-□	BT□□-FMA38.1-□□	BT□□-FMB40-□□
	4160R-□	BT□□-FMA50.8-□□	BT□□-FMC40-□□
	4200R-□	BT□□-FMA47.625-□□	BT□□-FMB60-□□
	4250R-□		
	4315R-□		
	4400R-□		

Parts

Specification	 Screw	 Shim	 Shim Screw	 Wrench
Ø80-Ø400	FTKA0412B	SS42RM8	SHXN0609F	TW15S

Available inserts E24~E26

Available arbors and bolt E426~E428

RM8AC(M)5000

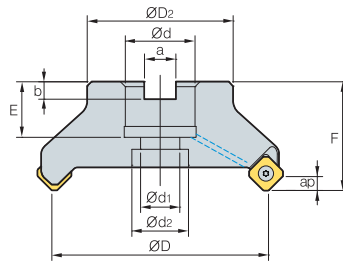


Fig. 1

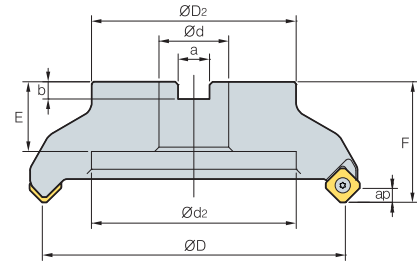


Fig. 2



AA
45°

• AR: -6°
• RR: -9°~6°

(mm)

Designation		$\varnothing D$	$\varnothing D_2$	$\varnothing d$	$\varnothing d_1$	$\varnothing d_2$	a	b	E	F	ap	$\frac{R}{kg}$	Fig.	
RM8AC (RM8ACM)	5080HR-M	6	80	57	25.4 (27)	14	20	9.5 (12.4)	6 (7)	25 (23)	50	7.5	1.2	1
	5100HR-M	7	100	67	31.75 (32)	18	26	12.7 (14.4)	8.0	33 (25)	63 (50)	7.5	2.5 (1.8)	1
	5125HR-M	8	125	87	38.1 (40)	22	32	15.9 (16.4)	10 (9)	35 (30)	63	7.5	3.6	1
	5160R-M	10	160	107	50.8 (40)	-	107	19 (16.4)	11 (9)	38 (32)	63	7.5	5 (4.56)	2
	5200R-M	12	200	130	47.625 (60)	-	135	25.4 (25.7)	14.0	38	63	7.5	7.1 (6.8)	2
	5250R-M	15	250	180	47.625 (60)	-	180	25.4 (25.7)	14.0	38	63	7.5	11.9 (10.6)	2
	5315R-M	20	315	240	47.625 (60)	-	238	25.4 (25.7)	14.0	38	63	7.5	19.1 (18.9)	2
	5400R-M	28	400	260	47.625 (60)	-	238	25.4 (25.7)	14.0	38	80	7.5	37.7 (37.5)	2

() Metric size

Available inserts

SNM(E)X-MF

SNEX-ML

SNM(E)X-MM



Designation	Cermet		Coated										Uncoated			page				
	CN2500	CN30	NC5330	NCM325	NCM335	NCM535	NCM545	PC2505	PC2010	PC3700	PC6510	PC9530	PC9540	PC5300	PC5400		ST30A	G10	H01	
SNEX	1507ANN-MF										●			●	●				E24	
	1507ANN-ML													●	●					E25
	1507ANN-MM													●	●					
SNMX	1507ANN-MF						●			●	●			●	●				E26	
	1507ANN-MM						●			●	●			●	●					

Available arbors

Designation	Available arbors		
	RM8AC	RM8ACM	
RM8AC	5080HR-□	BT□□-FMA25.4-□□	BT□□-FMC27-□□
(RM8ACM)	5100HR-□	BT□□-FMA31.75-□□	BT□□-FMC32-□□
	5125HR-□	BT□□-FMA38.1-□□	BT□□-FMB40-□□
	5160R-□	BT□□-FMA50.8-□□	BT□□-FMC40-□□
	5200R-□		
	5250R-□		
	5315R-□		
	5400R-□	BT□□-FMA47.625-□□	BT□□-FMB60-□□

Parts

Specification		
Ø80~Ø400	FTGA0513	TW20-100

Available inserts E24~E26

Available arbors and bolt E426~E428



RMH8AC(M)5000

Shim type

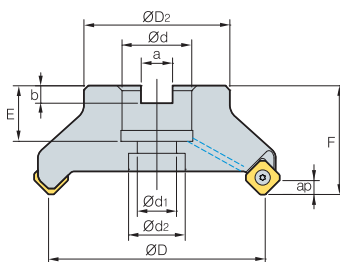


Fig. 1

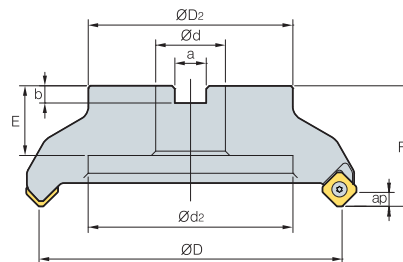


Fig. 2



AA
45°

- AR: -6°
- RR: -9°~-6°

(mm)

Designation	ØD	ØD2	Ød	Ød1	Ød2	a	b	E	F	ap	$\frac{V_c}{kg}$	Fig.	
RMH8AC (RMH8ACM) 5080HR-M	6	80	57	25.4 (27)	14	20	9.5 (12.4)	6 (7)	25 (23)	50	7.5	1.2	1
5100HR-M	7	100	67	31.75 (32)	18	26	12.7 (14.4)	8.0	33 (25)	63 (50)	7.5	2.5 (1.8)	1
5125HR-M	8	125	87	38.1 (40)	22	32	15.9 (16.4)	10 (9)	36 (30)	63	7.5	3.6	1
5160R-M	10	160	107	50.8 (40)	-	107	19 (16.4)	11 (9)	38 (32)	63	7.5	5 (4.56)	2
5200R-M	12	200	130	47.625 (60)	-	135	25.4 (25.7)	14.0	38 (32)	63	7.5	7.1 (6.8)	2
5250R-M	15	250	180	47.625 (60)	-	180	25.4 (25.7)	14.0	38 (32)	63	7.5	11.9 (10.6)	2
5315R-M	20	315	240	47.625 (60)	-	238	25.4 (25.7)	14.0	38	63	7.5	19.1 (18.9)	2
5400R-M	22	400	260	47.625 (60)	-	238	25.4 (25.7)	14.0	38	80	7.5	37.7 (37.5)	2

() Metric size

Available inserts

SNM(E)X-MF

SNEX-ML

SNM(E)X-MM



Designation	Cermet		Coated											Uncoated			page	
	CN2500	CN30	NC5330	NCM325	NCM335	NCM535	NCM545	PC2505	PC2010	PC3700	PC6510	PC9530	PC9540	PC5300	PC5400	ST30A		G10
SNEX 1507ANN-MF											●			●	●			
1507ANN-ML														●	●			
1507ANN-MM											●			●	●			
SNMX 1507ANN-MF						●				●	●			●	●			
1507ANN-MM						●				●	●			●	●			

Available arbors

Designation	Available arbors	
	RMH8AC	RMH8ACM
RMH8AC (RMH8ACM) 5080HR-□	BT□□-FMA25.4-□□	BT□□-FMC27-□□
5100HR-□	BT□□-FMA31.75-□□	BT□□-FMC32-□□
5125HR-□	BT□□-FMA38.1-□□	BT□□-FMB40-□□
5160R-□	BT□□-FMA50.8-□□	BT□□-FMC40-□□
5200R-□		
5250R-□		
5315R-□		
5400R-□	BT□□-FMA47.625-□□	BT□□-FMB60-□□

Parts

Specification				
Ø80-Ø400	FTGA0513	SS53RM8	SHXN0712F	TW20-100

Available inserts E24~E26

Available arbors and bolt E426~E428

RM8EC(M)4000

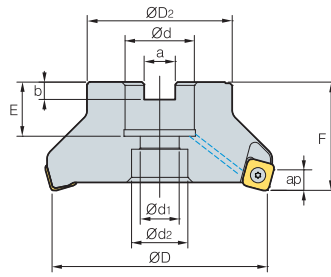


Fig. 1

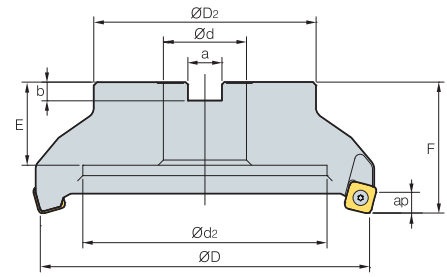


Fig. 2



AA
75°

• AR: -6°
• RR: -8°~6°

(mm)

Designation	⊙	ØD	ØD2	Ød	Ød1	Ød2	a	b	E	F	ap	$\frac{W}{kg}$	Fig.
RM8ECM 4050HR-M	4	50	49	22	11	18	10.4	6.3	20	40	9.0	0.4	1
RM8ECM 4063HR-M	6	63	49	22	11	18	10.4	6.3	20	40	9.0	0.6	1
RM8EC (RM8ECM) 4080HR	5	80	57	25.4 (27)	14	20	9.5 (12.4)	6 (7)	25 (23)	50	9.0	1.2	1
RM8EC (RM8ECM) 4080HR-M	7	80	57	25.4 (27)	14	20	9.5 (12.4)	6 (7)	25 (23)	50	9.0	1.1	1
RM8EC (RM8ECM) 4100HR	6	100	67	31.75 (32)	18	26	12.7 (14.4)	8	33 (25)	63 (50)	9.0	1.6	1
RM8EC (RM8ECM) 4100HR-M	8	100	67	31.75 (32)	18	26	12.7 (14.4)	8	33 (25)	63 (50)	9.0	2.5	1
RM8EC (RM8ECM) 4125HR	8	125	87	38.1 (40)	22	32	15.9 (16.4)	10 (9)	35 (29)	63	9.0	2.9 (3.3)	1
RM8EC (RM8ECM) 4125HR-M	10	125	87	38.1 (40)	22	32	15.9 (16.4)	10 (9)	35 (29)	63	9.0	3.0	1
RM8EC (RM8ECM) 4160R	10	160	107	50.8 (40)	-	107	19 (16.4)	11 (9)	38 (32)	63	9.0	4.4	2
RM8EC (RM8ECM) 4160R-M	12	160	107	50.8 (40)	-	107	19 (16.4)	11 (9)	38 (32)	63	9.0	4.0	2
RM8EC (RM8ECM) 4200R-M	16	200	130	47.625 (60)	-	135	25.4 (25.7)	14	38 (32)	63	9.0	5.9	2
RM8EC (RM8ECM) 4250R-M	16	250	180	47.625 (60)	-	180	25.4 (25.7)	14	38	63	9.0	10.9 (10.6)	2
RM8EC (RM8ECM) 4315R-M	20	315	240	47.625 (60)	-	238	25.4 (25.7)	14	38	63	9.0	18.1 (17.9)	2
RM8EC (RM8ECM) 4400R-M	28	400	260	47.625 (60)	-	238	25.4 (25.7)	14	38	80	9.0	31.8 (31.5)	2

Available inserts

() Metric size

SNM(E)X-MF

SNEX-ML

SNM(E)X-MM

SNEX-MA



Designation	Cermet		Coated										Uncoated			page			
	CN2500	CN30	NC5330	NCM325	NCM335	NCM535	NCM545	PC2505	PC2010	PC3700	PC6510	PC9530	PC9540	PC5300	PC5400		ST30A	G10	H01
SNEX 1206ENN-MF											●			●	●				E24 E25 E26
SNEX 1206ENN-ML											●			●	●				
SNEX 1206ENN-MM											●			●	●				
SNEX 1206ENN-MA											●			●	●			●	
SNMX 1206ENN-MF						●				●	●		●	●	●				
SNMX 1206ENN-MM						●				●	●		●	●	●				

Available arbors

Designation	NC arbors	
	RM8EC	RM8ECM
RM8ECM 4050HR-□	-	BT□□-FMC22-□□
RM8ECM 4063HR-□	-	BT□□-FMC27-□□
RM8EC (RM8ECM) 4080HR-□	BT□□-FMA25.4-□□	BT□□-FMC32-□□
RM8EC (RM8ECM) 4100HR-□	BT□□-FMA31.75-□□	BT□□-FMB40-□□
RM8EC (RM8ECM) 4125HR-□	BT□□-FMA38.1-□□	BT□□-FMC40-□□
RM8EC (RM8ECM) 4160R-□	BT□□-FMA50.8-□□	
RM8EC (RM8ECM) 4200R-□		
RM8EC (RM8ECM) 4250R-□		
RM8EC (RM8ECM) 4315R-□	BT□□-FMA47.625-□□	BT□□-FMB60-□□
RM8EC (RM8ECM) 4400R-□		

Parts

Specification	 Screw	 Wrench
Ø50~Ø400	PTKA0411-R3	TW15S

Available inserts E24~E26 Available arbors and bolt E426~E428



RMH8EC(M)4000

Shim type

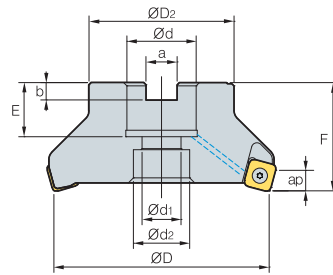


Fig. 1

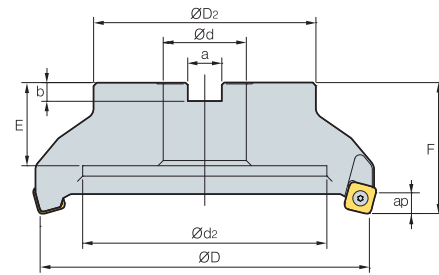


Fig. 2



• AR: -6°
• RR: -8°~6°

(mm)

Designation	ØD	ØD2	Ød	Ød1	Ød2	a	b	E	F	ap	$\frac{Ra}{\mu m}$	Fig.	
RMH8EC (RMH8ECM) 4080HR-M	7	80	57	25.4 (27)	14	20	9.5 (12.4)	6 (7)	25 (23)	50	9.0	1.1	1
4100HR-M	8	100	67	31.75 (32)	18	26	12.7 (14.4)	8	33 (25.5)	63 (50)	9.0	2.5	1
4125HR-M	10	125	87	38.1 (40)	22	32	15.9 (16.4)	10 (9)	36 (30)	63	9.0	3.0	1
4160R-M	12	160	107	50.8 (40)	-	107	19 (16.4)	11 (9)	38 (32)	63	9.0	4.0	2
4200R-M	16	200	130	47.625 (60)	-	135	25.4 (25.7)	14	38 (32)	63	9.0	5.9	2
4250R-M	16	250	180	47.625 (60)	-	180	25.4 (25.7)	14	38 (32)	63	9.0	10.9 (10.6)	2
4315R-M	20	315	240	47.625 (60)	-	238	25.4 (25.7)	14	38	63	9.0	18.1 (17.9)	2
4400R-M	24	400	260	47.625 (60)	-	238	25.4 (25.7)	14	38	80	9.0	31.8 (31.5)	2

() Metric size

Available inserts

SNM(E)X-MF SNEX-ML SNM(E)X-MM SNEX-MA



Designation	Cermet		Coated										Uncoated			page					
	CN2500	CN30	NC5330	NCM325	NCM335	NCM335	NCM335	NCM335	NCM335	PC2505	PC2010	PC3700	PC6510	PC9530	PC9540		PC5300	PC5400	ST30A	G10	H01
SNEX	1206ENN-MF												●			●	●				
	1206ENN-ML												●			●	●				
	1206ENN-MM												●			●	●				
	1206ENN-MA												●			●	●				●
SNMX	1206ENN-MF												●			●	●				
	1206ENN-MM												●			●	●				

Available arbors

Designation	Available arbors	
	RMH8EC	RMH8ECM
RMH8EC (RMH8ECM) 4080HR-□	BT□□-FMA25.4-□□	BT□□-FMC27-□□
4100HR-□	BT□□-FMA31.75-□□	BT□□-FMC32-□□
4125HR-□	BT□□-FMA38.1-□□	BT□□-FMB40-□□
4160R-□	BT□□-FMA50.8-□□	BT□□-FMC40-□□
4200R-□		
4250R-□		
4315R-□		
4400R-□	BT□□-FMA47.625-□□	BT□□-FMB60-□□

Parts

Specification	Screw	Shim	Shim Screw	Wrench
Ø80-Ø400	PTKA0411-R3	SS42RM8	SHXN0609F	TW15S

Available inserts E24~E26

Available arbors and bolt E426~E428

RM8EC(M)5000

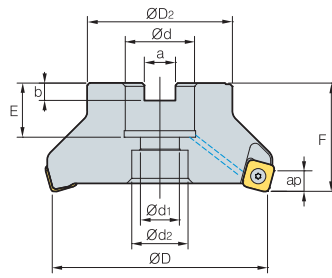


Fig. 1

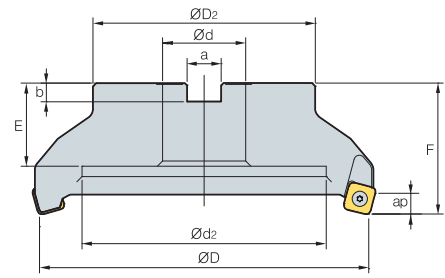


Fig. 2



AA
75°

- AR: -6°
- RR: -8°~6°

(mm)

Designation	ØD	ØD2	Ød	Ød1	Ød2	a	b	E	F	ap	kg	Fig.	
RM8EC (RM8ECM) 5080HR-M	6	80	57	25.4 (27)	14	20	9.5 (12.4)	6 (7)	25 (23)	50	11.0	1.1	1
5100HR-M	7	100	67	31.75 (32)	18	26	12.7 (14.4)	8.0	33 (25)	63 (50)	11.0	2.1 (1.7)	1
5125HR-M	8	125	87	38.1 (40)	22	32	15.9 (16.4)	10 (9)	35 (30)	63	11.0	3.4 (3.3)	1
5160R-M	10	160	107	50.8 (40)	-	107	19 (16.4)	11 (9)	38 (32)	63	11.0	4.4 (4.1)	2
5200R-M	12	200	130	47.625 (60)	-	135	25.4 (25.7)	14.0	38	63	11.0	6.4 (6.1)	2
5250R-M	15	250	180	47.625 (60)	-	180	25.4 (25.7)	14.0	38	63	11.0	11.0 (10.7)	2
5315R-M	20	315	240	47.625 (60)	-	238	25.4 (25.7)	14.0	38	63	11.0	18.0 (17.7)	2
5400R-M	28	400	260	47.625 (60)	-	238	25.4 (25.7)	14.0	38	80	11.0	35.7 (35.4)	2

()Metric size

Available inserts

SNM(E)X-MF

SNEX-ML

SNM(E)X-MM



Designation	Cermet		Coated										Uncoated			page			
	CN2500	CN30	NC5330	NCM325	NCM335	NCM535	NCM545	PC2505	PC2010	PC3700	PC6510	PC9530	PC9540	PC5300	PC5400		ST30A	G10	H01
SNEX 1507ENN-MF											●			●	●				E24
1507ENN-ML														●	●				
1507ENN-MM														●	●				
SNMX 1507ENN-MF						●				●	●			●	●				E26
1507ENN-MM						●				●	●			●	●				

Available arbors

Designation	Available arbors	
	RM8EC	RM8ECM
RM8EC (RM8ECM) 5080HR-□	BT□□-FMA25.4-□□	BT□□-FMC27-□□
5100HR-□	BT□□-FMA31.75-□□	BT□□-FMC32-□□
5125HR-□	BT□□-FMA38.1-□□	BT□□-FMB40-□□
5160R-□	BT□□-FMA50.8-□□	BT□□-FMC40-□□
5200R-□		
5250R-□	BT□□-FMA47.625-□□	BT□□-FMB60-□□
5315R-□		
5400R-□		

Parts

Specification	Screw	Wrench
Ø80~Ø400	FTGA0513	TW20-100

Available inserts E24~E26 Available arbors and bolt E426~E428



RMH8EC(M)5000

Shim type

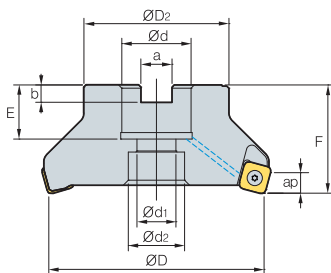


Fig. 1

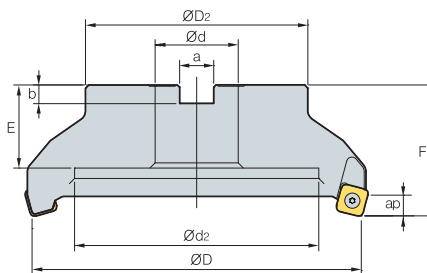


Fig. 2



AA
75°

• AR: -6°
• RR: -8°~6°

(mm)

Designation	⊙	ØD	ØD ₂	Ød	Ød ₁	Ød ₂	a	b	E	F	ap	kg	Fig.	
RMH8EC (RMH8ECM)	5080HR-M	6	80	57	25.4 (27)	14	20	9.5 (12.4)	6 (7)	25 (23)	50	11.0	1.1	1
	5100HR-M	7	100	67	31.75 (32)	18	26	12.7 (14.4)	8.0	33 (25.5)	63 (50)	11.0	2.1 (1.7)	1
	5125HR-M	8	125	87	38.1 (40)	22	32	15.9 (16.4)	10 (9)	36 (30)	63	11.0	3.4 (3.3)	1
	5160HR-M	10	160	107	50.8 (60)	-	107	19 (16.4)	11 (9)	38 (32)	63	11.0	4.4 (4.1)	2
	5200R-M	12	200	130	47.625 (60)	-	135	25.4 (25.7)	14.0	38 (32)	63	11.0	6.4 (6.1)	2
	5250R-M	15	250	180	47.625 (60)	-	180	25.4 (25.7)	14.0	38 (32)	63	11.0	110 (10.7)	2
	5315R-M	20	315	240	47.625 (60)	-	238	25.4 (25.7)	14.0	38	63	11.0	18.0 (17.7)	2
	5400R-H	22	400	260	47.625 (60)	-	238	25.4 (25.7)	14.0	38	80	11.0	35.7 (35.4)	2

() Metric size

Available inserts

SNM(E)X-MF

SNEX-ML

SNM(E)X-MM



Designation	Cermet		Coated											Uncoated			page		
	CN2500	CN30	NC5330	NCM325	NCM335	NCM535	NCM545	PC2505	PC2010	PC3700	PC6510	PC9530	PC9540	PC5300	PC5400	ST30A		G10	H01
SNEX	1507ENN-MF										●			●	●				E24 E25 E26
	1507ENN-ML													●	●				
	1507ENN-MM										●			●	●				
SNMX	1507ENN-MF					●				●	●			●	●				
	1507ENN-MM					●				●	●			●	●				

Available arbors

Designation	Available arbors	
	RMH8EC	RMH8ECM
RMH8EC (RMH8ECM) 5080HR-□	BT□□-FMA25.4-□□	BT□□-FMC27-□□
5100HR-□	BT□□-FMA31.75-□□	BT□□-FMC32-□□
5125HR-□	BT□□-FMA38.1-□□	BT□□-FMB40-□□
5160R-□	BT□□-FMA50.8-□□	BT□□-FMC40-□□
5200R-□		
5250R-□	BT□□-FMA47.625-□□	BT□□-FMB60-□□
5315R-□		
5400R-□		

Parts

Specification	 Screw	 Shim	 Shim Screw	 Wrench
Ø80-Ø400	FTGA0513	SS53RM8	SHXN0712F	TW20-100

Available inserts E24~E26

Available arbors and bolt E426~E428

RM8QC(M)4000

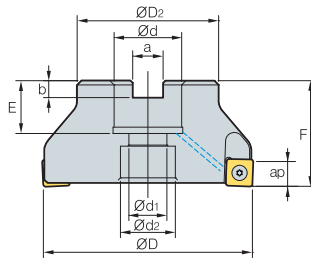


Fig. 1

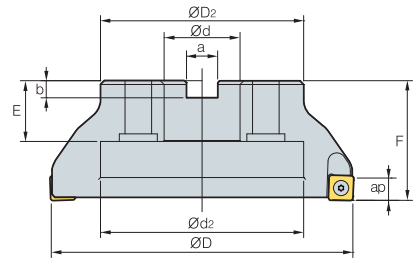


Fig. 2



AA
88°

• AR: -6°
• RR: -8°~6°

(mm)

Designation		ØD	ØD2	Ød	Ød1	Ød2	a	b	E	F	ap		Fig.
RM8QCM 4063HR-M	6	63	49	22	11	18	10.4	6.3	20	40	11.5	0.6	1
4063HR-H	8	63	49	22	11	18	10.4	6.3	20	40	11.5	0.6	1
RM8QC (RM8QCM) 4080HR-M	7	80	57	25.4 (27)	14	20	9.5 (12.4)	6 (7)	25 (23)	50	11.5	1.1	1
4080HR-H	10	80	57	25.4 (27)	14	20	9.5 (12.4)	6 (7)	25 (23)	50	11.5	1.0	1
4100HR-M	8	100	67	31.75 (32)	18	26	12.7 (14.4)	8	33 (25.5)	63 (50)	11.5	1.7	1
4100HR-H	12	100	67	31.75 (32)	18	26	12.7 (14.4)	8	33 (25.5)	63 (50)	11.5	1.6	1
4125HR-M	10	125	87	38.1 (40)	22	32	15.9 (16.4)	10 (9)	36 (30)	63	11.5	3.3	1
4125HR-H	14	125	87	38.1 (40)	22	32	15.9 (16.4)	10 (9)	36 (30)	63	11.5	3.3	1
4160R-M	12	160	107	50.8 (40)	-	107	19 (16.4)	11 (9)	38 (32)	63	11.5	3.9	2
4160R-H	18	160	107	50.8 (40)	-	107	19 (16.4)	11 (9)	38 (32)	63	11.5	3.9	2
4200R-M	14	200	130	47.625 (60)	-	135	25.4 (25.7)	14	38 (32)	63	11.5	6.4	2
4200R-H	22	200	130	47.625 (60)	-	135	25.4 (25.7)	14	38 (32)	63	11.5	6.4	2

Available inserts

() Metric size

SNM(E)X-MF

SNEX-ML

SNM(E)X-MM

SNEX-MA



Designation	Cermet		Coated										Uncoated			page			
	CN2500	CN30	NC5330	NCM325	NCM335	NCM535	NCM545	PC2505	PC2010	PC3700	PC6510	PC9530	PC9540	PC5300	PC5400		ST30A	G10	H01
SNEX 1206QNN-MF										●	●			●	●				
1206QNN-ML														●	●				
1206QNN-MM														●	●				
1206QNN-MA																			●
120612-MF											●			●	●				
120612-ML														●	●				
120612-MM											●			●	●				
120612-MA																			●
SNMX 1206QNN-MF						●				●	●			●	●				
1206QNN-MM						●				●	●			●	●				
120612-MF											●			●	●				
120612-MM											●			●	●				

Available arbors

Designation	Available arbors	
	RM8QC	RM8QCM
RM8QCM 4063HR-□	-	BT□□-FMC22-□□
RM8QC 4080HR-□	BT□□-FMA25.4-□□	BT□□-FMC27-□□
(RM8QCM) 4100HR-□	BT□□-FMA31.75-□□	BT□□-FMC32-□□
4125HR-□	BT□□-FMA38.1-□□	BT□□-FMB40-□□
4160R-□	BT□□-FMA50.8-□□	BT□□-FMC40-□□
4200R-□	BT□□-FMA47.625-□□	BT□□-FMB60-□□

Parts

Specification		
Ø63~Ø200	PTKA0411-R3	TW15S

Available inserts E24~E26 Available arbors and bolt E426~E428



RMH8QC(M)4000

Shim type

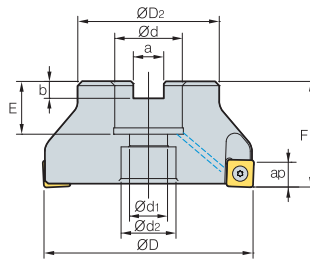


Fig. 1

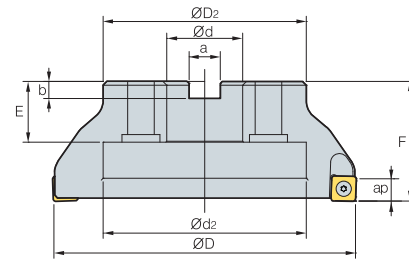


Fig. 2



(mm)

Designation	ØD	ØD2	Ød	Ød1	Ød2	a	b	E	F	ap	r_{ts}	Fig.		
RMH8QC (RMH8QCM)	4080HR-M	7	80	57	25.4 (27)	14	20	9.5 (12.4)	6 (7)	25 (23)	50	11.5	1.1	1
	4100HR-M	8	100	67	31.75 (32)	18	26	12.7 (14.4)	8	33 (25.5)	63 (50)	11.5	2.5	1
	4125HR-M	10	125	87	38.1 (40)	22	32	15.9 (16.4)	10 (9)	36 (30)	63	11.5	3.0	1
	4160R-M	12	160	107	50.8 (40)	-	107	19 (16.4)	11 (9)	38 (32)	63	11.5	4.0	2
	4200R-M	16	200	130	47.625 (60)	-	135	25.4 (25.7)	14	38 (32)	63	11.5	5.9	2

() Metric size

Available inserts

SNM(E)X-MM SNE(X)-ML SNM(E)X-MM SNE(X)-MA



Designation	Cermet		Coated										Uncoated			page			
	CN2500	CN30	NC5330	NCM325	NCM335	NCM335	NCM545	PC2505	PC2010	PC3700	PC6510	PC9330	PC9540	PC5300	PC5400		ST30A	G10	H01
SNE(X)	1206QNN-MF									●	●			●	●				E24 E25 E26
	1206QNN-ML													●	●				
	1206QNN-MM										●			●	●				
	1206QNN-MA																	●	
	120612-MF										●			●	●				
	120612-ML													●	●				
	120612-MM											●							
120612-MA																	●		
SNM(X)	1206QNN-MF					●			●	●			●	●					
	1206QNN-MM					●			●	●		●	●	●	●				
	120612-MF									●			●	●					
	120612-MM									●			●	●					

Available arbors

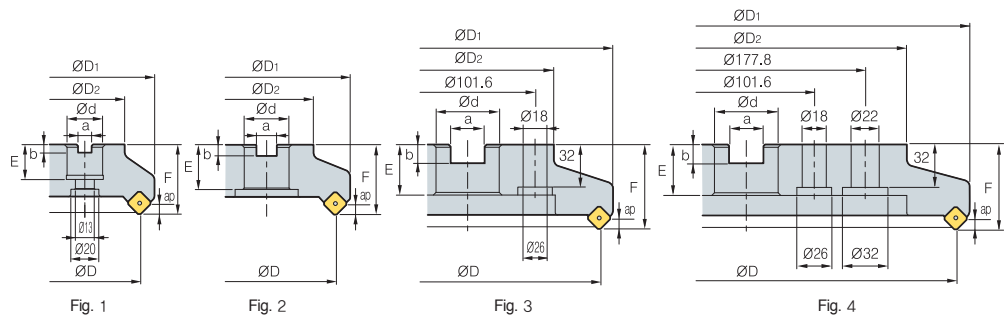
Designation	Available arbors	
	RMH8QC	RMH8QCM
RMH8QC (RMH8QCM) 4080HR-□	BT□□-FMA25.4-□□	BT□□-FMC27-□□
4100HR-□	BT□□-FMA31.75-□□	BT□□-FMC32-□□
4125HR-□	BT□□-FMA38.1-□□	BT□□-FMB40-□□
4160R-□	BT□□-FMA50.8-□□	BT□□-FMC40-□□
4200R-□	BT□□-FMA47.625-□□	BT□□-FMB60-□□

Parts

Specification	Screw	Shim	Shim Screw	Wrench
Ø80~Ø200	PTKA0411-R3	SS42RM8	SHXN0609F	TW15S

Available inserts E24~E26 Available arbors and bolt E426~E428

RMT8A(M)4000



AA
45°
• AR: -6°
• RR: -6°

(mm)

Designation	ØD	ØD1	ØD2	Ød	a	b	E	F	ap	kg	Fig.		
RMT8A (RMT8AM)	4080R	5	80	100	57	25.4 (27)	9.5 (12.4)	6 (7)	25 (22)	50	4	1.6	1
	4080R-M	6	80	100	57	25.4 (27)	9.5 (12.4)	6 (7)	25 (22)	50	4	1.6	1
	4100R	6	100	120	70	31.75 (32)	12.7 (14.4)	8 (8)	32 (28)	50	4	2.3	2
	4100R-M	8	100	120	70	31.75 (32)	12.7 (14.4)	8 (8)	32 (28)	50	4	2.3	2
	4125R	8	125	144	87	38.1 (40)	15.9 (16.4)	10 (9)	38 (30)	63	4	4.3	2
	4125R-M	10	125	144	87	38.1 (40)	15.9 (16.4)	10 (9)	38 (30)	63	4	4.3	2
	4160R	10	160	179	110	50.8 (40)	19.0 (16.4)	11 (9)	38 (30)	63	4	6.5	2
	4160R-M	14	160	179	110	50.8 (40)	19.0 (16.4)	11 (9)	38 (30)	63	4	6.5	2
	4200R	12	200	219	130	47.625 (60)	25.4 (25.7)	14 (14)	38 (38)	63	4	8.8	3
	4200R-M	18	200	219	130	47.625 (60)	25.4 (25.7)	14 (14)	38 (38)	63	4	8.8	3
	4250R	16	250	269	180	47.625 (60)	25.4 (25.7)	14 (14)	38 (38)	63	4	14.1	3
	4250R-M	22	250	269	180	47.625 (60)	25.4 (25.7)	14 (14)	38 (38)	63	4	14.1	3
	4315R	20	315	334	240	47.625 (60)	25.4 (25.7)	14 (14)	38 (38)	63	4	22.3	4
	4315R-M	28	315	334	240	47.625 (60)	25.4 (25.7)	14 (14)	38 (38)	63	4	22.3	4

Available inserts

() Metric size

SNC(M)F-MF SNC(M)F-MM



Designation	Cermet		Coated										Uncoated			page			
	CN2500	CN30	NC5330	NCM325	NCM335	NCM635	NCM645	PC2505	PC2010	PC3700	PC6510	PC9530	PC9540	PC5300	PC5400		ST30A	G10	H01
SNCF	1206ANN-MF																		E22
	1206ANN-MM																		
SNMF	1206ANN-MF																		E23
	1206ANN-MM																		

Available arbors

Designation	General arbors	NC arbors		
		RMT8A	RMT8AM	
RMT8A (RMT8AM)	<input type="checkbox"/> 080R	NT*□□(M/U)-FMA25.4-25	BT**□□-FMA25.4-□□	FMC27
	<input type="checkbox"/> 100R	NT*□□(M/U)-FMA31.75-□□	BT**□□-FMA31.75-□□	FMC32
	<input type="checkbox"/> 125R	NT*□□(M/U)-FMA38.1-□□	BT**□□-FMA38.1-□□	FMB40
	<input type="checkbox"/> 160R	NT*□□(M/U)-FMA50.8-□□	BT**□□-FMA50.8-□□	
	<input type="checkbox"/> 200R	NT*□□(M/U)-FMA47.625-25, KCP-8***	BT**□□-FMA47.625-□□	FMB60
	<input type="checkbox"/> 250R			
<input type="checkbox"/> 315R	KCP-8*** (Center ring plug)	-	-	

*□□-NT number **□□-BT number ***Over milling 5

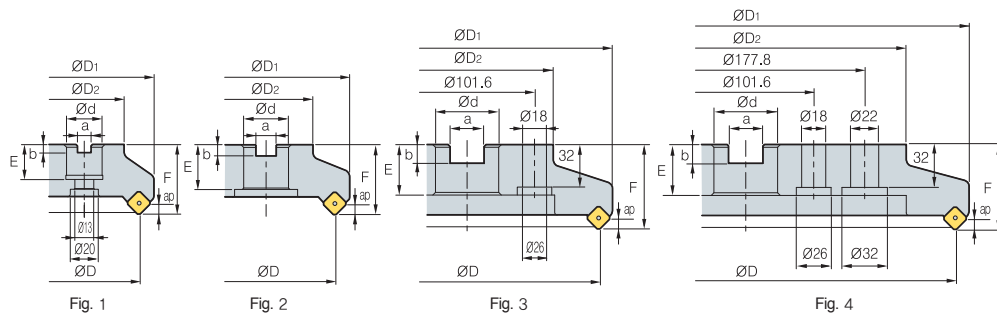
Parts

Specification					
Ø80~Ø315	ETKA0523	KHB0417	SPR0315	LTC05SR-RM4	TW20-100

Available inserts E22, E23 Available arbors and bolt E426~E428



RMT8A(M)5000



(mm)

Designation	⊙	ØD	ØD1	ØD2	Ød	a	b	E	F	ap	$\frac{\sigma}{kg}$	Fig.	
RMT8A (RMT8AM)	5080R	5	80	104	57	25.4 (27)	9.5 (12.4)	6 (7)	25 (22)	50	6	1.8	1
	5080R-M	6	80	104	57	25.4 (27)	9.5 (12.4)	6 (7)	25 (22)	50	6	1.8	1
	5100R	6	100	124	70	31.75 (32)	12.7 (14.4)	8 (8)	32 (28)	50	6	2.6	2
	5100R-M	8	100	124	70	31.75 (32)	12.7 (14.4)	8 (8)	32 (28)	50	6	2.6	2
	5125R	8	125	149	87	38.1 (40)	15.9 (16.4)	10 (9)	38 (30)	63	6	4.3	2
	5125R-M	10	125	149	87	38.1 (40)	15.9 (16.4)	10 (9)	38 (30)	63	6	4.3	2
	5160R	10	160	184	110	50.8 (40)	19.0 (16.4)	11 (9)	38 (30)	63	6	6.5	2
	5160R-M	14	160	184	110	50.8 (40)	19.0 (16.4)	11 (9)	38 (30)	63	6	6.5	2
	5200R	12	200	224	130	47.625 (60)	25.4 (25.7)	14 (14)	38 (38)	63	6	9.0	3
	5200R-M	18	200	224	130	47.625 (60)	25.4 (25.7)	14 (14)	38 (38)	63	6	9.0	3
	5250R	16	250	274	180	47.625 (60)	25.4 (25.7)	14 (14)	38 (38)	63	6	14.4	3
	5250R-M	22	250	274	180	47.625 (60)	25.4 (25.7)	14 (14)	38 (38)	63	6	14.4	3
	5315R	20	315	339	240	47.625 (60)	25.4 (25.7)	14 (14)	38 (38)	63	6	22.2	4
	5315R-M	28	315	339	240	47.625 (60)	25.4 (25.7)	14 (14)	38 (38)	63	6	22.2	4

Available inserts

() Metric size

SNC(M)F-MF SNC(M)F-MM



Designation	Cermet		Coated										Uncoated			page				
	CN2500	CN30	NC5330	NCM25	NCM335	NCM335	NCM535	NCM545	PC2505	PC2010	PC3700	PC6510	PC9530	PC9540	PC5300		PC5400	ST30A	G10	H01
SNCF	1507ANN-MF											●								E22 E23
	1507ANN-MM																			
SNMF	1507ANN-MF																			
	1507ANN-MM																			

Available arbors

Designation	General arbors	NC arbors		
		RMT8A	RMT8AM	
RMT8A (RMT8AM)	<input type="checkbox"/> 080R	NT* <input type="checkbox"/> <input type="checkbox"/> (M/U)-FMA25.4-25	BT** <input type="checkbox"/> <input type="checkbox"/> (M/U)-FMA25.4- <input type="checkbox"/> <input type="checkbox"/>	FMC27
	<input type="checkbox"/> 100R	NT* <input type="checkbox"/> <input type="checkbox"/> (M/U)-FMA31.75- <input type="checkbox"/> <input type="checkbox"/>	BT** <input type="checkbox"/> <input type="checkbox"/> (M/U)-FMA31.75- <input type="checkbox"/> <input type="checkbox"/>	FMC32
	<input type="checkbox"/> 125R	NT* <input type="checkbox"/> <input type="checkbox"/> (M/U)-FMA38.1- <input type="checkbox"/> <input type="checkbox"/>	BT** <input type="checkbox"/> <input type="checkbox"/> (M/U)-FMA38.1- <input type="checkbox"/> <input type="checkbox"/>	FMB40
	<input type="checkbox"/> 160R	NT* <input type="checkbox"/> <input type="checkbox"/> (M/U)-FMA50.8- <input type="checkbox"/> <input type="checkbox"/>	BT** <input type="checkbox"/> <input type="checkbox"/> (M/U)-FMA50.8- <input type="checkbox"/> <input type="checkbox"/>	FMB60
	<input type="checkbox"/> 200R	NT* <input type="checkbox"/> <input type="checkbox"/> (M/U)-FMA47.625-25, KCP-8***	BT** <input type="checkbox"/> <input type="checkbox"/> (M/U)-FMA47.625- <input type="checkbox"/> <input type="checkbox"/>	FMB60
	<input type="checkbox"/> 250R			
<input type="checkbox"/> 315R	KCP-8*** (Center ring plug)	-	-	-

*-NT number **-BT number ***Over milling 5

Parts

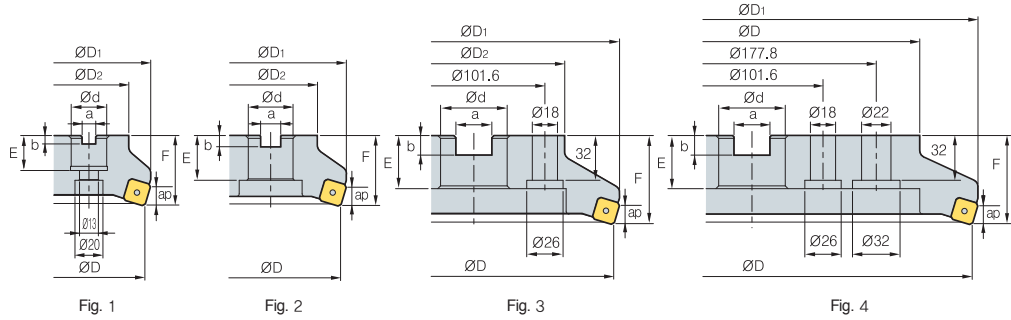
Specification					
Ø80-Ø315	ETKA0625	KHB0417	SPR0415	LTC06SR-RM5	TW20-100

Available inserts E22, E23

Available arbors and bolt E426~E428



RMT8E(M)4000



AA
75°
• AR: -6°
• RR: -8°~6°

(mm)

Designation	ØD	ØD1	ØD2	Ød	a	b	E	F	ap	kg	Fig.	
RMT8E (RMT8EM) 4080R	5	80	100	57	25.4 (27)	9.5 (12.4)	6 (7)	25 (22)	50	5	1.5	1
4080R-M	6	80	100	57	25.4 (27)	9.5 (12.4)	6 (7)	25 (22)	50	5	1.5	1
4100R	6	100	120	67	31.75 (32)	12.7 (14.4)	8 (8)	32 (28)	50	5	2	2
4100R-M	8	100	120	67	31.75 (32)	12.7 (14.4)	8 (8)	32 (28)	50	5	2	2
4125R	8	125	144	87	38.1 (40)	15.9 (16.4)	10 (9)	38 (30)	63	5	3.8	2
4125R-M	10	125	144	87	38.1 (40)	15.9 (16.4)	10 (9)	38 (30)	63	5	3.8	2
4160R	10	160	179	107	50.8 (40)	19.0 (16.4)	11 (9)	38 (30)	63	5	5.8	2
4160R-M	14	160	179	107	50.8 (40)	19.0 (16.4)	11 (9)	38 (30)	63	5	5.8	2
4200R	12	200	219	130	47.625 (60)	25.4 (25.7)	14 (14)	38 (38)	63	5	7.9	3
4200R-M	18	200	219	130	47.625 (60)	25.4 (25.7)	14 (14)	38 (38)	63	5	7.9	3
4250R	16	250	269	180	47.625 (60)	25.4 (25.7)	14 (14)	38 (38)	63	5	13.0	3
4250R-M	22	250	269	180	47.625 (60)	25.4 (25.7)	14 (14)	38 (38)	63	5	13.0	3
4315R	20	315	334	240	47.625 (60)	25.4 (25.7)	14 (14)	38 (38)	63	5	20.5	4
4315R-M	28	315	334	240	47.625 (60)	25.4 (25.7)	14 (14)	38 (38)	63	5	20.5	4

Available inserts

() Metric size

SNC(M)F-MF SNC(M)F-MM



Designation	Cermet		Coated										Uncoated			page			
	CN2500	CN30	NC5330	NCM825	NCM835	NCM635	NCM645	PC2505	PC2010	PC3700	PC6510	PC9530	PC9540	PC5300	PC5400		ST30A	G10	H01
SNCF 1206ENN-MF											●								E22
1206ENN-MM																			
SNMF 1206ENN-MF										●									E23
1206ENN-MM										●									

Available arbors

Designation	General arbors	NC arbors	
		RMT8E	RMT8EM
RMT8E (RMT8EM) □080R	NT*□□(M/U)-FMA25.4-25	BT**□□-FMA25.4-□□	FMC27
□100R	NT*□□(M/U)-FMA31.75-□□	BT**□□-FMA31.75-□□	FMC32
□125R	NT*□□(M/U)-FMA38.1-□□	BT**□□-FMA38.1-□□	FMB40
□160R	NT*□□(M/U)-FMA50.8-□□	BT**□□-FMA50.8-□□	
□200R	NT*□□(M/U)-FMA47.625-25, KCP-8***	BT**□□-FMA47.625-□□	FMB60
□250R			
□315R	KCP-8*** (Center ring plug)	-	-

*□□-NT number **□□-BT number ***Over milling 5

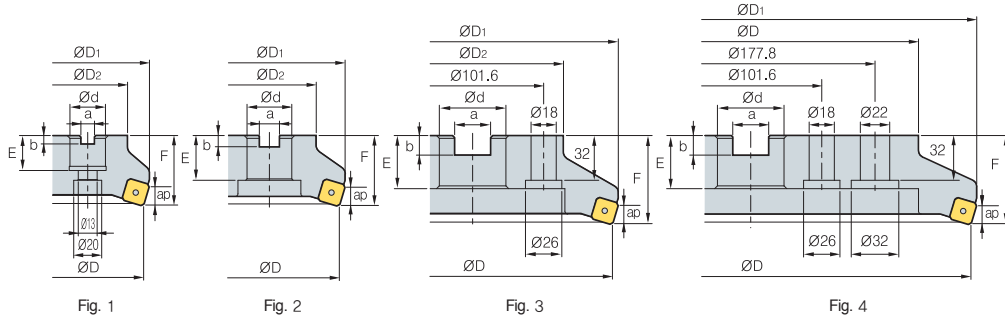
Parts

Specification	Screw	Screw	Spring	Latch	Wrench
Ø80~Ø315	ETKA0523	KHB0417	SPR0315	LTC05SR-RM4	TW20-100

Available inserts E22, E23 Available arbors and bolt E426-E428



RMT8E(M)5000



AA
75°

• AR: -6°
• RR: -8°~6°

Designation			ØD	ØD1	ØD2	Ød	a	b	E	F	ap		Fig.
RMT8E (RMT8EM)	5080R	5	80	88	57	25.4 (27)	9.5 (12.4)	6 (7)	25 (22)	50	8	1.4	1
	5080R-M	6	80	88	57	25.4 (27)	9.5 (12.4)	6 (7)	25 (22)	50	8	1.4	1
	5100R	6	100	108	67	31.75 (32)	12.7 (14.4)	8 (8)	32 (28)	50	8	1.9	2
	5100R-M	8	100	108	67	31.75 (32)	12.7 (14.4)	8 (8)	32 (28)	50	8	1.9	2
	5125R	8	125	133	87	38.1 (40)	15.9 (16.4)	10 (9)	38 (30)	63	8	3.7	2
	5125R-M	10	125	133	87	38.1 (40)	15.9 (16.4)	10 (9)	38 (30)	63	8	3.7	2
	5160R	10	160	168	107	50.8 (40)	19.0 (16.4)	11 (9)	38 (30)	63	8	5.7	2
	5160R-M	14	160	168	107	50.8 (40)	19.0 (16.4)	11 (9)	38 (30)	63	8	5.7	2
	5200R	12	200	208	130	47.625 (60)	25.4 (25.7)	14 (14)	38 (38)	63	8	7.5	3
	5200R-M	18	200	208	130	47.625 (60)	25.4 (25.7)	14 (14)	38 (38)	63	8	7.5	3
	5250R	16	250	258	180	47.625 (60)	25.4 (25.7)	14 (14)	38 (38)	63	8	12.4	3
	5250R-M	22	250	258	180	47.625 (60)	25.4 (25.7)	14 (14)	38 (38)	63	8	12.4	3
	5315R	20	315	323	240	47.625 (60)	25.4 (25.7)	14 (14)	38 (38)	63	8	19.9	4
	5315R-M	28	315	323	240	47.625 (60)	25.4 (25.7)	14 (14)	38 (38)	63	8	19.9	4

(mm)

Available inserts

SNC(M)F-MF SNC(M)F-MM



Designation	Cermet		Coated										Uncoated			page				
	CN2500	CN30	NC5330	NCM325	NCM335	NCM335	NCM535	NCM545	PC2505	PC2010	PC3700	PC6510	PC9530	PC9540	PC5300		PC5400	ST30A	G10	H01
SNCF	1507ENN-MF											●								E22
	1507ENN-MM																			
SNMF	1507ENN-MF											●								E23
	1507ENN-MM																			

() Metric size

Available arbors

Designation	General arbors	NC arbors		
		RMT8E	RMT8EM	
RMT8E (RMT8EM)	□080R	NT*□□(M/U)-FMA25.4-□□	BT**□□-FMA25.4-□□	FMC27
	□100R	NT*□□(M/U)-FMA31.75-□□	BT**□□-FMA31.75-□□	FMC32
	□125R	NT*□□(M/U)-FMA38.1-□□	BT**□□-FMA38.1-□□	FMB40
	□160R	NT*□□(M/U)-FMA50.8-□□	BT**□□-FMA50.8-□□	
	□200R	NT*□□(M/U)-FMA47.625-25, KCP-8***	BT**□□-FMA47.625-□□	FMB60
	□250R			
□315R	KCP-8*** (Center ring plug)	-	-	

*□□-NT number **□□-BT number ***Over milling 5

Parts

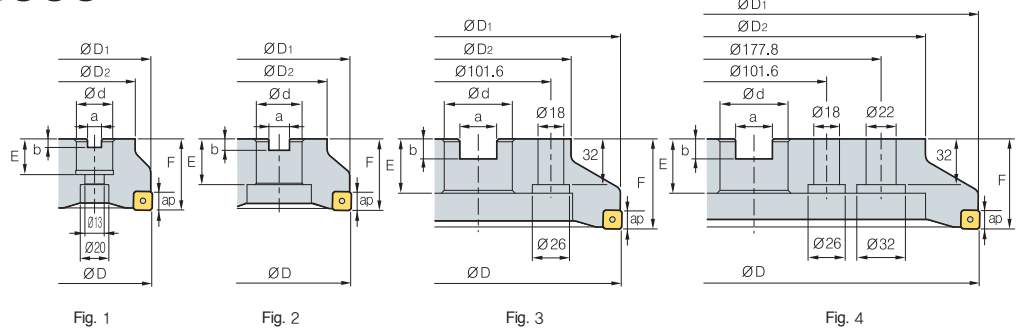
Specification					
Ø80-Ø315	ETKA0625	KHB0417	SPR0415	LTC06SR-RM5	TW20-100

Available inserts E22, E23

Available arbors and bolt E426~E428



RMT8Q(M)4000



AA
88°
• AR: -6°
• RR: -11°~6°

Designation		⊙	ØD	ØD1	ØD2	Ød	a	b	E	F	ap	kg	Fig.
RMT8Q (RMT8QM)	4080R	5	80	79	57	25.4 (27)	9.5 (12.4)	6 (7)	25 (22)	50	5	1.4	1
	4080R-M	6	80	79	57	25.4 (27)	9.5 (12.4)	6 (7)	25 (22)	50	5	1.4	1
	4100R	6	100	99	67	31.75 (32)	12.7 (14.4)	8 (8)	32 (28)	50	5	1.8	2
	4100R-M	8	100	99	67	31.75 (32)	12.7 (14.4)	8 (8)	32 (28)	50	5	1.8	2
	4125R	8	125	124	87	38.1 (40)	15.9 (16.4)	10 (9)	38 (30)	63	5	3.6	2
	4125R-M	10	125	124	87	38.1 (40)	15.9 (16.4)	10 (9)	38 (30)	63	5	3.6	2
	4160R	10	160	159	107	50.8 (40)	19.0 (16.4)	11 (9)	38 (30)	63	5	5.7	2
	4160R-M	14	160	159	107	50.8 (40)	19.0 (16.4)	11 (9)	38 (30)	63	5	5.7	2
	4200R	12	200	199	130	47.625 (60)	25.4 (25.7)	14 (14)	38 (38)	63	5	7.5	3
	4200R-M	18	200	199	130	47.625 (60)	25.4 (25.7)	14 (14)	38 (38)	63	5	7.5	3
	4250R	16	250	249	180	47.625 (60)	25.4 (25.7)	14 (14)	38 (38)	63	5	12.5	3
	4250R-M	22	250	249	180	47.625 (60)	25.4 (25.7)	14 (14)	38 (38)	63	5	12.5	3
	4315R	20	315	314	240	47.625 (60)	25.4 (25.7)	14 (14)	38 (38)	63	5	19.9	4
	4315R-M	28	315	314	240	47.625 (60)	25.4 (25.7)	14 (14)	38 (38)	63	5	19.9	4

Available inserts

() Metric size

SNC(M)F-MF SNC(M)F-MM



Designation	Cermet		Coated										Uncoated			page		
	CN2500	CN30	NC6330	NCM325	NCM335	NCM535	NCM545	PC2505	PC2010	PC3700	PC6510	PC9530	PC9540	PC5300	PC5400		ST30A	G10
SNCF	1206QNN-MF										●							
	1206QNN-MM										●							
SNMF	1206QNN-MF									●								
	1206QNN-MM									●								

Available arbors

Designation	General arbors	NC arbors		
		RMT8Q	RMT8QM	
RMT8Q (RMT8QM)	□080R	NT*□□(M/U)-FMA25.4-25	BT**□□-FMA25.4-□□	FMC27
	□100R	NT*□□(M/U)-FMA31.75-□□	BT**□□-FMA31.75-□□	FMC32
	□125R	NT*□□(M/U)-FMA38.1-□□	BT**□□-FMA38.1-□□	FMB40
	□160R	NT*□□(M/U)-FMA50.8-□□	BT**□□-FMA50.8-□□	
	□200R	NT*□□(M/U)-FMA47.625-25, KCP-8***	BT**□□-FMA47.625-□□	FMB60
	□250R			
□315R	KCP-8*** (Center ring plug)	-	-	

*□□-NT number **□□-BT number ***Over milling 5

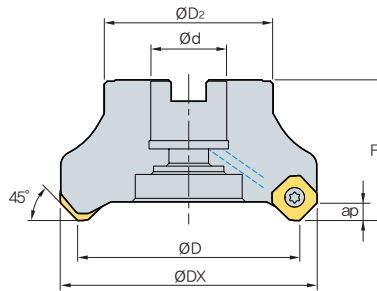
Parts

Specification	Screw	Screw	Spring	Latch	Wrench
Ø80~Ø315	ETKA0523	KHB0417	SPR0315	LTC05SR-RM4	TW20-100

Available inserts E22, E23 Available arbors and bolt E426-E428



RMX8AC(M)-SA14 new



AA
45°

• AR: -8°
• RR: -11°~-9°

(mm)

Designation		ØDX	ØD	ØD2	Ød	F	ap	
RMX8ACM	050R-22-4-SA14	4	62.5	50	42	22	40	0.34
	050R-22-5-SA14	5	62.5	50	42	22	40	0.38
	063R-22-5-SA14	5	75.5	63	42	22	40	0.56
	063R-22-6-SA14	6	75.5	63	42	22	40	0.54
	080R-27-6-SA14	6	92.5	80	60	27	50	1.00
	080R-27-8-SA14	8	92.5	80	60	27	50	1.04
	100R-32-8-SA14	8	112.5	100	70	32	50	2.05
	100R-32-10-SA14	10	112.5	100	70	32	50	2.06
	125R-40-8-SA14	8	137.5	125	90	40	63	3.34
	125R-40-12-SA14	12	137.5	125	90	40	63	3.34
RMX8AC	080R-25.4-6-SA14	6	92.5	80	60	25.4	50	1.02
	080R-25.4-8-SA14	8	92.5	80	60	25.4	50	1.06
	100R-31.75-8-SA14	8	112.5	100	70	31.75	63	2.08
	100R-31.75-10-SA14	10	112.5	100	70	31.75	63	2.09
	125R-38.1-8-SA14	8	137.5	125	90	38.1	63	3.43
	125R-38.1-12-SA14	12	137.5	125	90	38.1	63	3.35

Available inserts

SAGX-ML SAGX-MM SNMX-MM



Designation	Cermet		Coated											Uncoated			page	
	CN2500	CN30	NC5330	NCM325	NCM335	NCM535	NCM545	PC2505	PC2510	PC2010	PC3700	PC6510	PC9530	PC9540	PC5300	ST30A		G10
SAGX 140808ANER-ML														●	●			
140808ANER-MM															●			
SNMX 140808ANER-MM											●	●			●			

Available arbors

Designation	Ød	Available arborss
RMX8ACM 050R-22-□-SA14	22	BT□□-FMC22-□□
063R-22-□-SA14		
080R-27-□-SA14	27	BT□□-FMC27-□□
100R-32-□-SA14	32	BT□□-FMC32-□□
125R-40-□-SA14	40	BT□□-FMC40-□□

Designation	Ød	Available arbors
RMX8AC 080R-25.4-□-SA14	25.4	BT□□-FMC25.4-□□
100R-31.75-□-SA14	31.75	BT□□-FMC31.75-□□
125R-38.1-□-SA14	38.1	BT□□-FMC38.1-□□

Parts

Specification		
Ø50~Ø125	FTNA0513	TW20-100

Available inserts E18 Available arbors and bolt E426~E428

RM14XCM-XN06 new

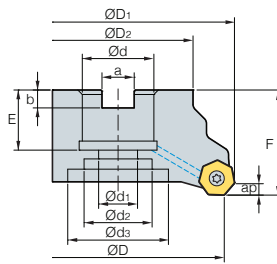


Fig. 1

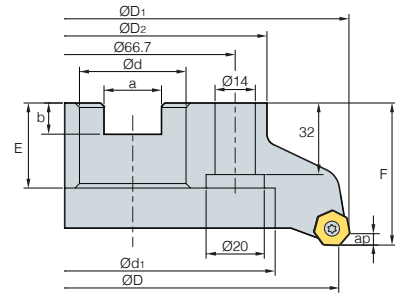


Fig. 2



(mm)

Designation		$\varnothing D$	$\varnothing D_1$	$\varnothing D_2$	$\varnothing d$	$\varnothing d_1$	$\varnothing d_2$	$\varnothing d_3$	a	b	E	F	ap		Fig.	
RM14XCM 050R-22-5-XN06		5	50	58.6	42	22	11	18	-	10.4	6.3	21	40	3.5	0.34	1
050R-22-6-XN06		6	50	58.6	42	22	11	18	-	10.4	6.3	21	40	3.5	0.34	1
063R-22-6-XN06		6	63	71.6	42	22	11	18	-	10.4	6.3	21	40	3.5	0.51	1
063R-22-8-XN06		8	63	71.6	42	22	11	18	-	10.4	6.3	21	40	3.5	0.58	1
080R-27-6-XN06		6	80	88.6	57	27	14	20	35	12.4	7.0	23	50	3.5	0.98	1
080R-27-8-XN06		8	80	88.6	57	27	14	20	35	12.4	7.0	23	50	3.5	1.08	1
080R-27-10-XN06		10	80	88.6	57	27	14	20	35	12.4	7.0	23	50	3.5	1.07	1
100R-32-10-XN06		10	100	108.6	67	32	18	26	42	14.4	8.0	25	63	3.5	1.60	1
100R-32-12-XN06		12	100	108.6	67	32	18	26	42	14.4	8.0	25	63	3.5	1.58	1
125R-40-12-XN06		12	125	133.6	90	40	22	32	54	16.4	9.0	29	63	3.5	3.43	1
125R-40-14-XN06		14	125	133.6	90	40	22	32	54	16.4	9.0	29	63	3.5	3.40	1
160NR-40-16-XN06		16	160	168.6	110	40	90	-	-	16.4	9.0	32	63	3.5	4.86	2
160NR-40-18-XN06		18	160	168.6	110	40	90	-	-	16.4	9.0	32	63	3.5	4.84	2

* In applying XNMX060608-□□, Max. ap = 4.8 mm

Available inserts

XNMX-ML XNMX-ML



Designation	Cermet		Coated										Uncoated			page			
	CN2500	CN30	NC5330	NCM325	NCM335	NCM535	NCM645	PC2505	PC2010	PC3700	PC6510	PC9530	PC9540	PC5300	PC5400		ST30A	G10	H01
XNMX 0606XNR-ML						●					●	●	●	●					E32
060608-ML						●					●	●	●	●					E32

Available arbors

Designation	$\varnothing d$	Available arbors
RM14XCM 050R	22	BT□□-FMC22-□□
063R		
080R	27	BT□□-FMC27-□□
100R		
125R	32	BT□□-FMC32-□□
160R		
	40	BT□□-FMC40-□□

Parts

Specification		
$\varnothing 50 \sim \varnothing 160$	FTKA0412B	TW15S

Available inserts E32 Available arbors and bolt E426-E428



RM16AC(M)6000

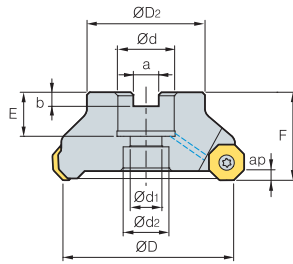


Fig. 1

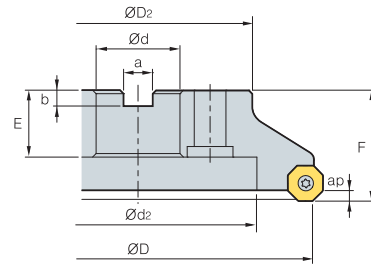


Fig. 2



AA
45°

• AR: -6°
• RR: -6°

(mm)

Designation		ØD	ØD2	Ød	Ød1	Ød2	a	b	E	F	ap		Fig.
RM16ACM 6063HR-M	5	63	49	22	11	18	10.4	6.3	20	40	4.0	0.7	1
RM16AC (RM16ACM) 6080HR-M	6	80	57	25.4 (27)	14	20	9.5 (12.4)	6 (7)	25 (23)	50	4.0	1.2	1
6100HR-M	7	100	67	31.75 (32)	18	26	12.7 (14.4)	8	33 (25)	63 (50)	4.0	1.9	1
6125HR-M	8	125	87	38.1 (40)	22	32	15.9 (16.4)	10 (9)	35 (29)	63	4.0	3.5	1
6160R-M	10	160	107	50.8 (40)	-	107	19 (16.4)	11 (9)	38 (32)	63	4.0	4.1	2
6200R-M	12	200	130	47.625 (60)	-	135	25.4 (25.7)	14	38 (32)	63	4.0	6.1	2
6250R-M	15	250	180	47.625 (60)	-	180	25.4 (25.7)	14	38	63	4.0	11.5	2
6315R-M	20	315	240	47.625 (60)	-	238	25.4 (25.7)	14	38	63	4.0	18.9	2
6400R-M	26	400	260	47.625 (60)	-	238	25.4 (25.7)	14	38	80	4.0	32.7	2

() Metric size

Available inserts



Designation	Cermet		Coated										Uncoated			page			
	CN2500	CN30	NC5330	NCM325	NCM335	NCM335	NCM335	NCM345	PC2505	PC2010	PC3700	PC6510	PC9530	PC9540	PC5300		PC5400	ST30A	G10
ONHX 060608-MM												●							
060608-MF												●							
060608-ML																			
060608-MA																			●
060608-W												●	●						
0606ANN-MM												●							
0606ANN-MF												●							
ONMX 060608-MM												●		●					
060608-MF												●							
0606ANN-MM												●							
0606ANN-MF												●	●						

Available arbors

Designation	Available arbors	
	RM16AC	RM16ACM
RM16AC 6063HR-M		BT□□-FMC22-□□
(RM16ACM) 6080HR-M	BT□□-FMA25.4-□□	BT□□-FMC27-□□
6100HR-M	BT□□-FMA31.75-□□	BT□□-FMC32-□□
6125HR-M	BT□□-FMA38.1-□□	BT□□-FMB40-□□
6160R-M	BT□□-FMA50.8-□□	BT□□-FMC40-□□
6200R-M		
6250R-M		
6315R-M	BT□□-FMA47.625-□□	BT□□-FMB60-□□
6400R-M		

Parts

Specification		
Ø63-Ø400	FTGA0513	TW20-100

Available inserts E15 Available arbors and bolt E426-E428

RM16AC(M)8000

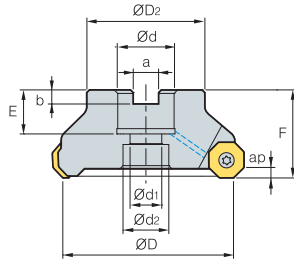


Fig. 1

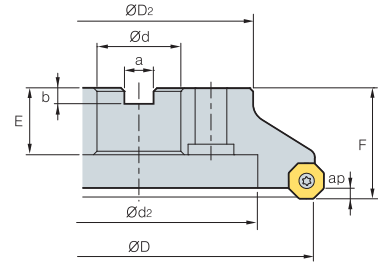


Fig. 2



AA
45°

- AR: -6°
- RR: -6°

(mm)

Designation		ØD	ØD2	Ød	Ød1	Ød2	a	b	E	F	ap		Fig.	
RM16ACM 8063HR-M		5	63	49	22	11	18	10.4	6.3	20	40	5.5	0.7	1
RM16AC 8080HR-M		6	80	57	25.4 (27)	14	20	9.5 (12.4)	6 (7)	25 (23)	50	5.5	1.2	1
(RM16ACM) 8100HR-M		7	100	67	31.75 (32)	18	26	12.7 (14.4)	8	33 (25)	63 (50)	5.5	1.8	1
8125HR-M		8	125	87	38.1 (40)	22	32	15.9 (16.4)	10 (9)	35 (29)	63	5.5	3.5	1
8160R-M		10	160	107	50.8 (40)	-	107	19 (16.4)	11 (9)	38 (32)	63	5.5	4.5	2
8200R-M		12	200	130	47.625 (60)	-	135	25.4 (25.7)	14 (14)	38 (32)	63	5.5	5.8	2
8250R-M		14	250	180	47.625 (60)	-	180	25.4 (25.7)	14	38	63	5.5	11.4	2
8315R-M		18	315	240	47.625 (60)	-	238	25.4 (25.7)	14	38	63	5.5	18.8	2
8400R-M		24	400	260	47.625 (60)	-	238	25.4 (25.7)	14	38	80	5.5	32.7	2

()Metric size

Available inserts



Designation	Cermet		Coated										Uncoated			page			
	CN2500	CN30	NC5330	NCM325	NCM335	NCM535	NCM545	PC2505	PC2010	PC3700	PC6510	PC9530	PC9540	PC5300	PC5400		ST30A	G10	H01
ONHX 080608-MM											●			●	●				E15
080608-MF											●			●	●				
080608-ML														●	●				
080608-MA																		●	
080608-W											●								
0806ANN-MM											●			●	●				
0806ANN-MF											●			●	●				
ONMX 080608-MM						●				●	●	●		●	●				
080608-MF						●				●	●	●		●	●				
0806ANN-MM						●				●	●	●		●	●				
0806ANN-MF						●				●	●	●		●	●				

Available arbors

Designation	Available arbors	
	RM16AC	RM16ACM
RM16AC 8063HR-M	-	BT□□-FMC22-□□
(RM16ACM) 8080HR-M	BT□□-FMA25.4-□□	BT□□-FMC27-□□
8100HR-M	BT□□-FMA31.75-□□	BT□□-FMC32-□□
8125HR-M	BT□□-FMA38.1-□□	BT□□-FMB40-□□
8160R-M	BT□□-FMA50.8-□□	BT□□-FMC40-□□
8200R-M		
8250R-M		
8315R-M		
8400R-M	BT□□-FMA47.625-□□	BT□□-FMB60-□□

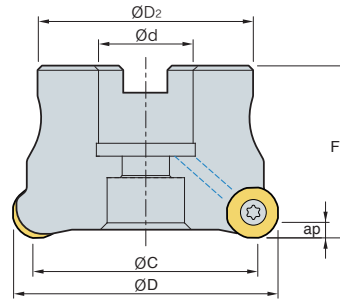
Parts

Specification		
Ø63~Ø400	FTGA0513	TW20-100

Available inserts E15 Available arbors and bolt E426-E428



RMRC(M)-RN12 new



- AR: -7°
- RR: -13°

(mm)

Designation		ØD	ØC	ØD2	Ød	F	ap		
RMRCM	050R-22-5-RN12	5	50	40.4	42	22	40	3.5	0.28
	050R-22-6-RN12	6	50	40.4	42	22	40	3.5	0.29
	063R-22-6-RN12	6	63	53.4	42	22	40	3.5	0.45
	063R-22-7-RN12	7	63	53.4	42	22	40	3.5	0.46
	080R-27-6-RN12	6	80	70.4	60	27	50	3.5	0.83
	080R-27-8-RN12	8	80	70.4	60	27	50	3.5	0.82
	100R-32-7-RN12	7	100	90.4	70	32	63	3.5	1.67
	100R-32-9-RN12	9	100	90.4	70	32	63	3.5	1.67
	125R-40-10-RN12	10	125	115.4	90	40	63	3.5	2.82
	125R-40-12-RN12	12	125	115.4	90	40	63	3.5	2.83
RMRC	080R-25.4-6-RN12	6	80	70.4	60	25.4	50	3.5	0.85
	080R-25.4-8-RN12	8	80	70.4	60	25.4	50	3.5	0.85
	100R-31.75-7-RN12	7	100	90.4	70	31.75	63	3.5	1.71
	100R-31.75-9-RN12	9	100	90.4	70	31.75	63	3.5	1.71
	125R-38.1-10-RN12	10	125	115.4	90	38.1	63	3.5	2.88
	125R-38.1-12-RN12	12	125	115.4	90	38.1	63	3.5	2.88

Available inserts

RNMX-ML



Designation	Cermet		Coated										Uncoated			page			
	CN2500	CN30	NC5330	NCM325	NCM335	NCM335	NCM545	PC2505	PC2010	PC3700	PC6510	PC9530	PC9540	UNC840	UPC845		ST30A	G10	H01
RNMX 1204M0E-ML														●	●				E17

Available arbors

Designation	Ød	Available arbors	Designation	Ød	Available arbors
RMRCM 050R-22-□-RN12	22	BT□□-FMC22-□□	RMRC 080R-25.4-□-RN12	25.4	BT□□-FMC25.4-□□
063R-22-□-RN12			100R-31.75-□-RN12		
080R-27-□-RN12	27	BT□□-FMC27-□□	125R-38.1-□-RN12	38.1	BT□□-FMC38.1-□□
100R-32-□-RN12	32	BT□□-FMC32-□□			
125R-40-□-RN12	40	BT□□-FMC40-□□			

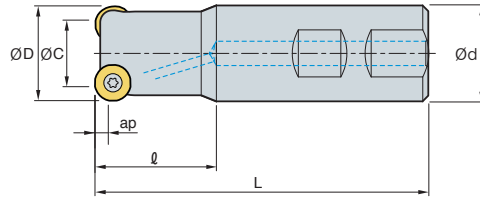
Parts

Specification		
Ø50-Ø125	FTNA0411-A	TW15S

Available inserts E17

Available arbors and bolt E426-E428

RMRS-RN12 new



• AR: -7°
• RR: -15°~13°

(mm)

Designation		ØD	ØC	Ød	ℓ	L	Shank	ap	
RMRS 032R-2W32-110-RN12	2	32	22.4	32	40	110	W	3.5	0.56
032R-3W32-110-RN12	3	32	22.4	32	40	110	W	3.5	0.55
032R-2C32-200-RN12	2	32	22.4	32	40	200	C	3.5	1.09
032R-3C32-200-RN12	3	32	22.4	32	40	200	C	3.5	1.09
040R-3W32-110-RN12	3	40	30.4	32	40	110	W	3.5	0.62
040R-4W32-110-RN12	4	40	30.4	32	40	110	W	3.5	0.62
040R-3C32-200-RN12	3	40	30.4	32	40	200	C	3.5	1.15
040R-4C32-200-RN12	4	40	30.4	32	40	200	C	3.5	1.15
050R-5W40-120-RN12	5	50	40.4	40	40	120	W	3.5	1.08
050R-6W40-120-RN12	6	50	40.4	40	40	120	W	3.5	1.08
050R-5C42-300-RN12	5	50	40.4	42	40	300	C	3.5	3.05
050R-6C42-300-RN12	6	50	40.4	42	40	300	C	3.5	3.05
063R-6W40-130-RN12	6	63	53.4	40	50	130	W	3.5	1.43
063R-7W40-130-RN12	7	63	53.4	40	50	130	W	3.5	1.43
063R-6C42-300-RN12	6	63	53.4	42	50	300	C	3.5	3.30
063R-7C42-300-RN12	7	63	53.4	42	50	300	C	3.5	3.26

Available inserts

RNMX-ML



Designation	Cermet		Coated										Uncoated			page			
	CN2500	CN30	NC5330	NCM325	NCM335	NCM535	NCM645	PC2505	PC2010	PC3700	PC6510	PC9530	PC9540	UNC840	UPC845		ST30A	G10	H01
RNMX 1204M0E-ML														●	●				E17

Parts

Specification		
Ø32~Ø63	FTNA0411-A	TW15S

Available inserts E17 Available arbors and bolt E426-E428

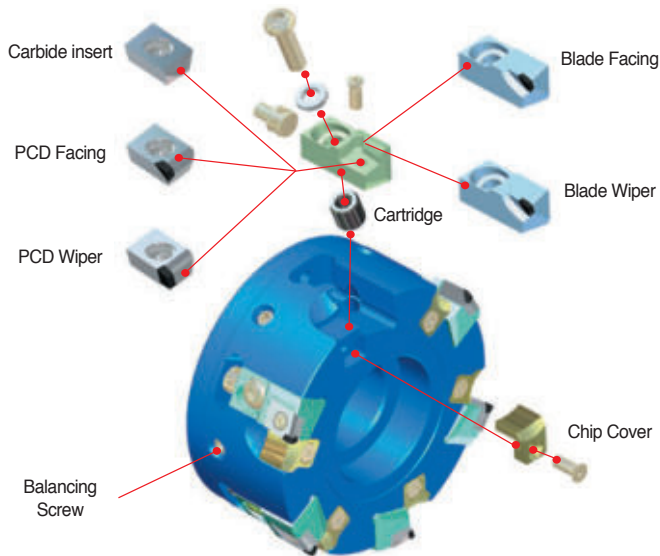


Lighter tool ensures excellent performance in high speed machining

Aero Mill

- Excellent machining performance can be acquired especially at the high speeds due to the light aluminum cutter body that is 50% of the weight of a conventional steel cutter body
- High speed milling cutter for precise machining
- Special aluminum material and high rake angle of insert provide rigid & stable machining
- High tolerance surface finishes can be acquired due to the low cutting load provided from the high rake angle
- Balanceable up to G2.5 level

➤ Assembly structure of cutter



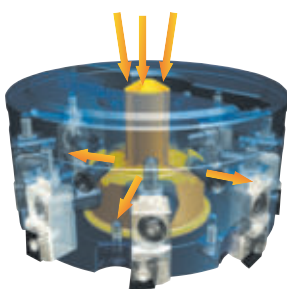
➤ Features of cutter

- Increased stability based on cartridge type application
- Both insert and blade can be available in the same cutter
- Finishing to roughing can be possible because of wide chip pocket space
- Roughing and finishing available with carbide, PCD insert application
- Cutter breakage can be solved by making use of the chip cover

➤ Coolant through system

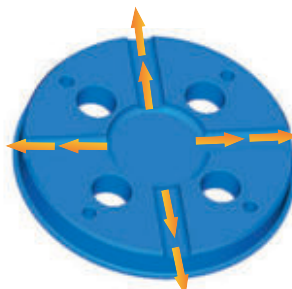
- Specially designed coolant through system provides coolant from the center of the cutter to the insert enhances the cooling rate and chip evacuation.
- Direction of coolant has designed to focus directly to the insert cutting-edge to maximize chip evacuation and improve tool life
- Coolant bolt is applicable up to $\varnothing 160$, coolant cover is applicable from $\varnothing 200$ and over.
Coolant devices are sold separately for through coolant system, through coolant arbor has to be used

Coolant Bolt



For $\varnothing 80\sim\varnothing 160$

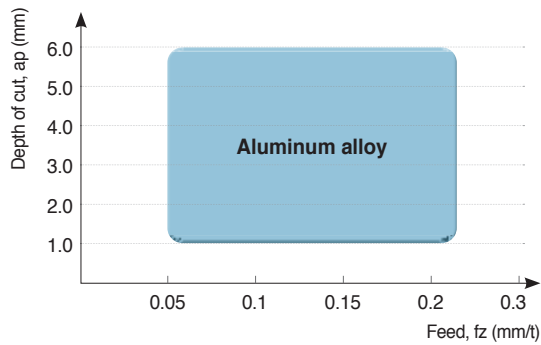
Coolant Cover



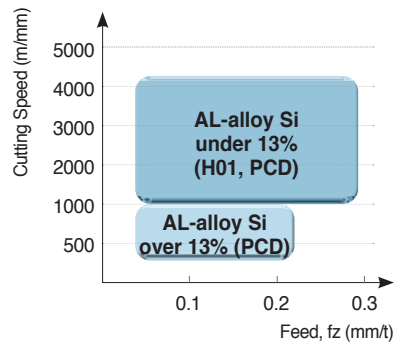
For $\varnothing 200$ and over

Aero Mill

Application range

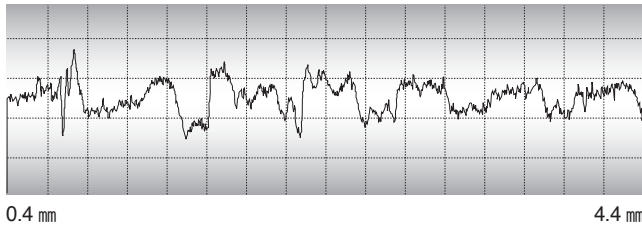


Recommended cutting condition



Surface finish

- **Workpiece** A6061
- **Cutting condition** $vc = 1570$ m/min $vf = 3000$ mm/min
 $S = 5000$ rpm $fz = 0.1$ mm/t
 $ap = 0.5$ mm Machine = PCV620
- **Designation** **Cutter** APD100R-A6Z (6 Flutes)
Insert CDEW1204R-XCF (H01)



- Rmax: 2.1 μ m
- Rz: 1.6 μ m
- Ra: 0.3 μ m

Max. revolution

Diameter (mm)	Max. revolution (rpm)
Ø80	16,000
Ø100	15,000
Ø125	12,500
Ø160	10,000
Ø200	8,000
Ø250	6,500
Ø315	5,000

Coolant parts

Diameter (mm)	Type	Designation		Shape	Note
Ø80	Coolant Bolt	CBP080-IN/MM			Extra charge
Ø100	Coolant Bolt	CBP100-IN	CBP100-MM-1		
Ø125	Coolant Bolt	CBP125-IN	CBP125-MM-1		
Ø160	Coolant Bolt	CBP160-IN	CBP160-MM		
Ø200	Coolant Cover	CCP200			
Ø250	Coolant Cover	CCP250			
Ø315	Coolant Cover	CCP315			

• Choice: CBP100-IN:APD type, General for unmarked item

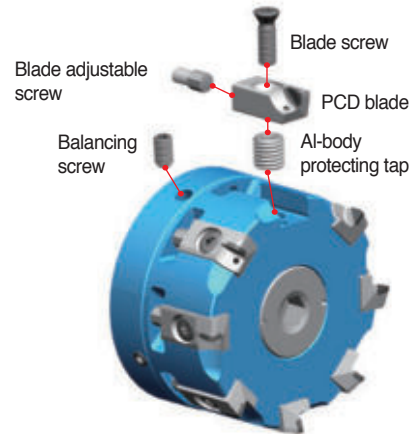


High speed milling tool with PCD blade

Aero Mill-Plus

- Improve tool life up to 20% with a coolant system that enables direct spray cooling to cutting blades
- Enable high feed milling by increasing the number of cutting blades by 20% through a simply structured coupling method for clamps
- Reduces set up time up to 40% by applying a spanner adjustment method
- Introduce an aluminum cutter body to provide a superior cutting performance during high speed milling

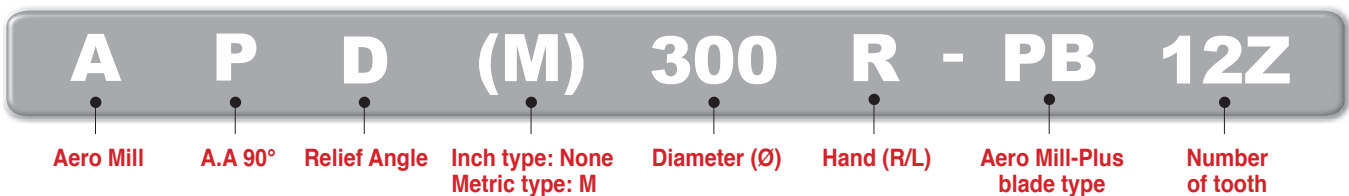
Assembly structure of cutter



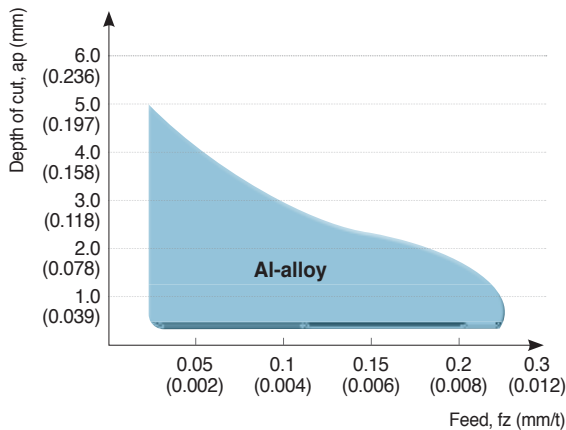
Features of cutter

- Prevent overload to the spindle bearings through weight reduction of the Al alloy body and enable high-speed processing
- Provide PCD Blade-dedicated cutter design to offer stable tool life and increase of applied blades
- Improve the blade life by applying a coolant system that enables direct spray cooling to cutting blades
- Adopt a clamping method with simple structure without set screw
- Reduce weight and apply a coolant bolt that is exclusively used for Aero-Mill Plus that applies coolant to remove internal chip

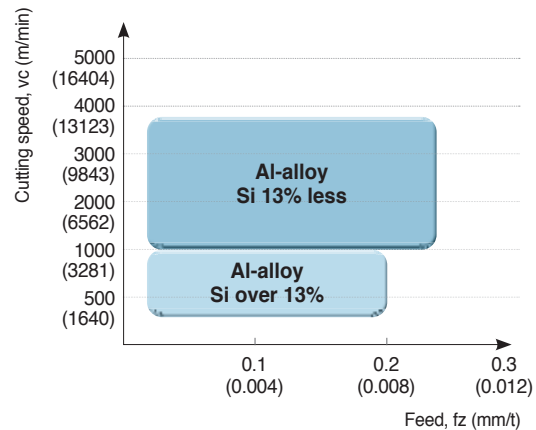
Code system



Application range



Recommended cutting speed



Max. RPM

Diameter (mm)	Max. revolution (rpm)
Ø80	20,000
Ø100	18,000
Ø125	16,000
Ø160	13,000
Ø200	10,000
Ø250	8,000
Ø315	7,000

Coolant parts

Diameter (mm)	Type	inch/mm	Designation	Shape	Material	Note
Ø80	Coolant bolt	inch, mm	CB12-AMaP80		Steel	Included
		inch	CB16-AMP100			
		mm	CB16-AMP100M			
		inch	CB20-AMP125			
		mm	CB20-AMP125M			
		inch	CB24-AMP160			
Ø160	Coolant cover	inch, mm	CCV-AMP200		Aluminum	Extra charge
		inch, mm	CCV-AMP250			
		inch, mm	CCV-AMP315			

E Technical information for Aero Mill-Mini

Good performance in small-medium size of operations

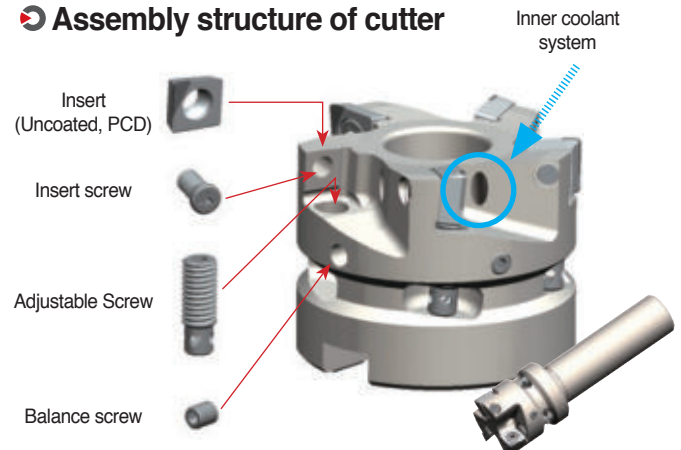
Aero Mill-Mini

- Good performance in small-medium size of operations
- Good duration of the steel body
- Choice of Uncoated carbide/PCD grades can be applied to various kind of work material
- Balance level: G2.5

Features of cutter

- Simple and strong design of Screw-on clamping.
- Adjustable range: ± 0.1 mm Max
- Adjustable step: Min. 2 micro meter
- Wide chip pocket area for Roughing and Aluminum machining.
- Inner coolant system

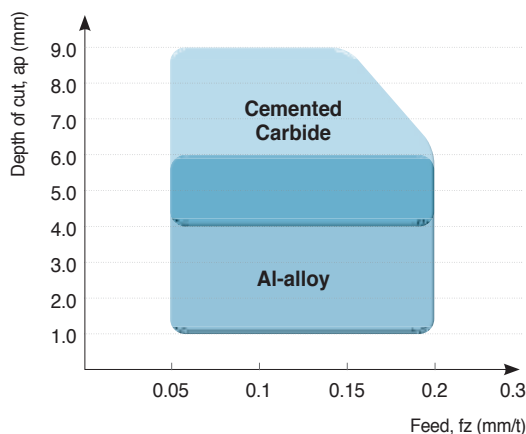
Assembly structure of cutter



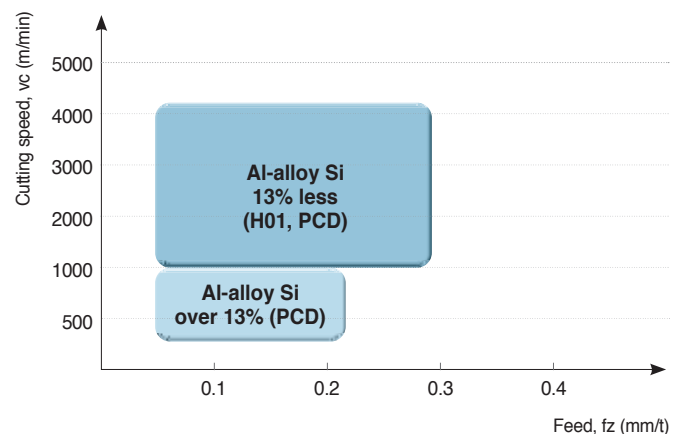
Code system



Application range



Recommended cutting condition



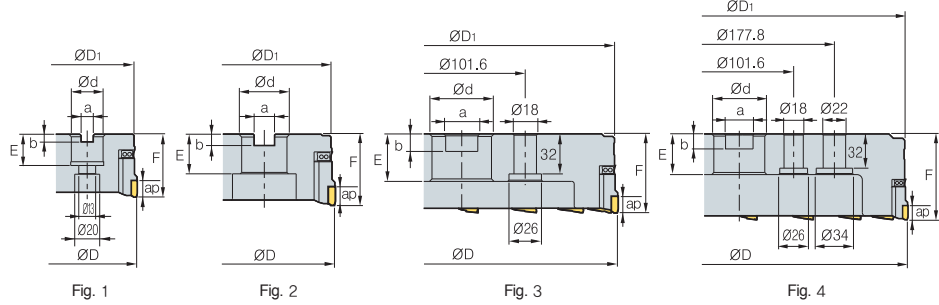
Max. RPM

Diameter	Max. RPM (min ⁻¹)
Ø32	26,000
Ø40	24,500
Ø50	22,000
Ø63	20,000



APD(M)-A

Cartridge + insert



AA
90°
• AR: 6°
• RR: 5°~9°

Designation		ØD	ØD1	Ød	a	b	E	F	ap	Max rpm	kg	Fig.	
APD (APDM)	080R/L-A6Z	6	80	76	25.4 (27)	9.5 (12.4)	6 (7)	25 (22)	50	10	16000	0.75	1
	100R/L-A6Z	6	100	95	31.75 (32)	12.7 (14.4)	8 (8)	32 (28)	50	10	15000	0.95	2
	125R/L-A8Z	8	125	120	38.1 (40)	15.9 (16.4)	10 (9)	38 (30)	63	10	12500	1.8	2
	160R/L-A10Z	10	160	155	50.8 (40)	19.0 (16.4)	11 (9)	38 (30)	63	10	10000	2.9	2
	200R/L-A12Z	12	200	195	47.625 (60)	25.4 (25.7)	14 (14)	38 (38)	63	10	8000	4.0	3
	250R/L-A16Z	16	250	245	47.625 (60)	25.4 (25.7)	14 (14)	38 (38)	63	10	6500	6.3	3
	315R/L-A18Z	18	315	310	47.625 (60)	25.4 (25.7)	14 (14)	38 (38)	80	10	5000	11.3	4

(mm)

() Metric size

Available inserts

CDEW-XCF CDEW-XAF,NAF CDEW-XAW,NAW



Designation	Uncoated			PCD	page
	H01	G10	ST30A	DP200	
CDEW	1204R-XCF	●			E07
	1204L-XCF				
	1204R-XAF			●	
	1204L-XAF				
	1204R-NAF			●	
	1204L-NAF				
	1204R-XAW			●	
	1204L-XAW				
	1204R-NAW			●	
	1204L-NAW				

Available arbors

Designation	General arbors	NC arbors
APD	080R/L NT*□□(M/U)-FMA25.4-25	BT**□□-FMA25.4
(APDM)	100R/L NT*□□(M/U)-FMA31.75-□□	BT**□□-FMA31.75
	125R/L NT*□□(M/U)-FMA38.1-□□	BT**□□-FMA38.1
	160R/L NT*□□(M/U)-FMA50.8-□□	BT**□□-FMA50.8
	200R/L NT*□□(M/U)-FMA47.625-25,	BT**□□-FMA47.625-□□
	250R/L KCP-8***	
	315R/L KCP-8*** (Center ring plug)	-

*□□-NT number **□□-BT number ***Over milling 5

Recommended cutting condition

Workpiece	Cutting condition		Grades
	vc (m/min)	fz (mm/t)	
Aluminum	1,000~4,000 500~2,500	0.05~0.30 0.05~0.20	DP200 H01

Parts

Specification								
Ø80-Ø315	LAPDR/L-AJ	CAPDR/L-AJ	PTMA0411	FTNA0411	AZ0514	BHA0619-NYLOK	TW15S	HW50

Available inserts E07 Available arbors and bolt E426-E428

APD(M)-PB

Blade

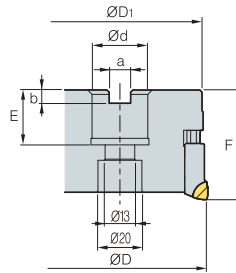
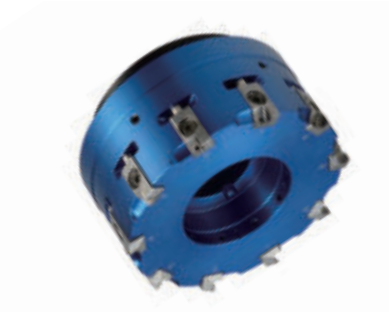


Fig. 1

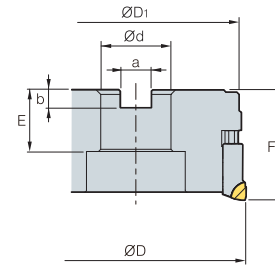


Fig. 2



AA
90°

• AR: 6°
• RR: -4°~1°

(mm)

Designation		Max 	ØD	ØD ₁	Ød	a	b	E	F	ap		Fig.	
APD (APDM)	080R/L-PB6Z	6	10	80	77	25.4 (27)	9.5 (12.4)	6 (7)	23.5	50	5	0.55	1
	080R/L-PB8Z	8	10	80	77	25.4 (27)	9.5 (12.4)	6 (7)	23.5	50	5	0.55	1
	100R/L-PB6Z	6	12	100	97	31.75 (32)	12.7 (14.4)	8	34 (32)	50	5	0.92	2
	100R/L-PB8Z	8	12	100	97	31.75 (32)	12.7 (14.4)	8	34 (32)	50	5	0.92	2
	125R/L-PB8Z	8	14	125	122	38.1 (40)	15.9 (16.4)	10 (9)	40 (35)	63	5	1.9	2
	125R/L-PB10Z	10	14	125	122	38.1 (40)	15.9 (16.4)	10 (9)	40 (35)	63	5	1.9	2
	160R/L-PB10Z	10	20	160	157	50.8 (40)	19.0 (16.4)	11 (9)	41 (35)	63	5	3.3	2
	160R/L-PB12Z	12	20	160	157	50.8 (40)	19.0 (16.4)	11 (9)	41 (35)	63	5	3.3	2

() Metric size

Available blades

BAMPR-XAF BAMPR-XAW BAMPR-XAWR



Designation	PCD	page
	DP150	
BAMPR-XAF		E07
BAMPR-XAW	●	
BAMPR-XAWR	●	

Available arbors

Designation	NC arbors
APD-PB (APDM-PB)	BT□□-FMA25.4(FMC27)-□□
	BT□□-FMA31.75(FMC32)-□□
	BT□□-FMA38.1(FMB40)-□□
	BT□□-FMA50.8(FMB/FMC40)-□□

Parts

Specification						
Ø80~Ø160	ETKA0620	AZ0514-SPN6	UZD1010	KHE0610	SPN-6	TW25-100

Available inserts E07 Available arbors and bolt E426~E428



APD(M)-PB

Blade

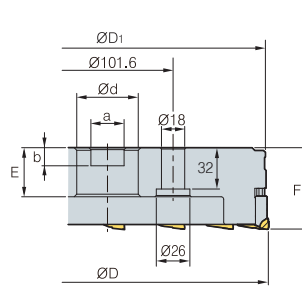
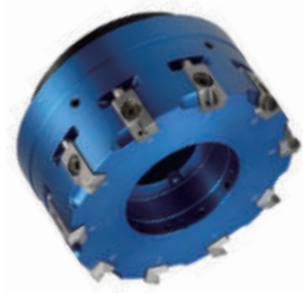


Fig. 1

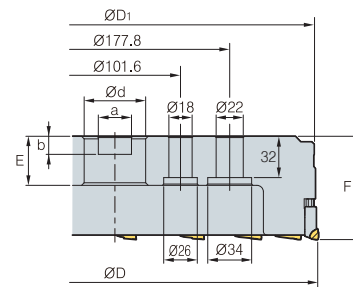


Fig. 2



AA
90°

• AR: -6°
• RR: -39°~-16°

(mm)

Designation		Max	ØD	ØD1	Ød	a	b	E	F	ap	kg	Fig.
APD (APDM)	200R/L-PB12Z	12	200	197	47.625 (60)	25.4 (25.7)	14	40	63	5	4.0	1
	250R/L-PB16Z	16	250	247	47.625 (60)	25.4 (25.7)	14	40	63	5	6.5	1
	315R/L-PB18Z	18	315	312	47.625 (60)	25.4 (25.7)	14	40	63	5	11.3	2

() Metric size

Available blades

BAMPR-XAF BAMPR-XAW BAMPR-XAWR



Designation	PCD		page
	DP150		
BAMPR-XAF			E07
BAMPR-XAW	●		
BAMPR-XAWR	●		

Available arbors

Designation	NC arbors
APD-PB (APDM-PB)	
200R/L-PB□□Z	
250R/L-PB□□Z	BT□□-FMA47.625(FMB60)-□□
315R/L-PB□□Z	

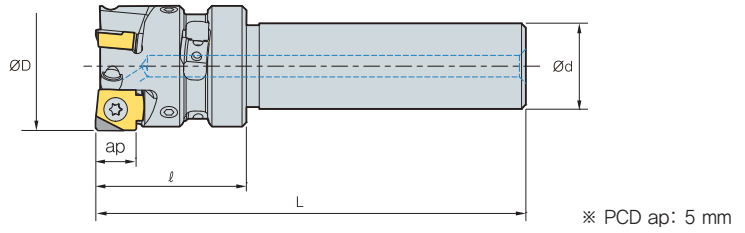
Parts

Specification						
Ø200~Ø315	ETKA0620	AZ0514-SPN6	UZD1010	KHE0610	SPN-6	TW25-100

Available inserts E07

Available arbors and bolt E426~E428

MAPDS000HR/L-Z0

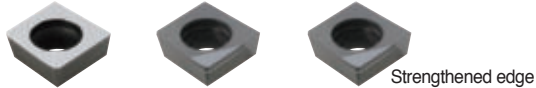


(mm)

Designation		ØD	Ød	l	L	ap	Max rpm	
MAPDS	032HR/L-Z3	3	32	20	35	100	9.5	0.35
	040HR/L-Z4	4	40	20	35	100	9.5	0.42

Available inserts

SNEW SNEW-XAF SNEW-NAF



Designation	Uncoated			PCD	page
	H01	G10	ST30A	DP200	
SNEW	09T3ADFR	●			E24
	09T3ADTR-XAF			●	
	09T3ADTR-XAW			●	
	09T3ADTR-NAF			●	
	09T3ADTR-NAW			●	

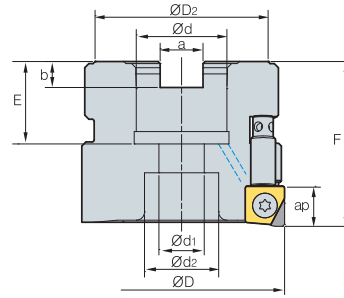
Parts

Specification					
Ø32~Ø63	FTKA0408	AHX0617F-NYLOK	KHD0405	TW15S	HW20L

Available inserts E24



MAPD000HR/L-Z0



※ PCD ap: 5 mm



AA
90°

• AR: 6°
• RR: -1°~12°

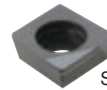
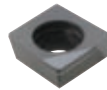
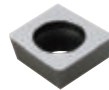
Designation		⊙	ØD	ØD2	Ød	a	b	E	F	Ød1	Ød2	ap	Max rpm	kg
MAPD	040HR/L-Z4	4	40	34	16	8.4	5.6	18	40	9	14	9.5	24,000	0.24
	050HR/L-Z5	5	50	42	22	10.4	6.3	20	40	11	18	9.5	22,000	0.35
	063HR/L-Z6	6	63	42	22	10.4	6.3	20	40	11	18	9.5	20,000	0.65

Available inserts

SNEW

SNEW-XAF

SNEW-NAF



Strengthened edge

Designation	Uncoated				PCD	page
	H01	G10	ST30A	ST20	DP200	
SNEW	09T3ADFR	●				E24
	09T3ADTR-XAF				●	
	09T3ADTR-XAW				●	
	09T3ADTR-NAF				●	
	09T3ADTR-NAW				●	

Available arbors

Designation	NC arbors
MAPD	
040HR/L-Z4	BT**□□-FMC16-□□
050HR/L-Z5	BT**□□-FMC22-□□
063HR/L-Z6	BT**□□-FMC22-□□

Recommended cutting condition

Workpiece	Cutting condition		Grades
	vc (m/min)	fz (mm/t)	
Aluminum	1,000~4,000 500~2,500	0.05~0.30 0.05~0.20	DP200 H01

Coolant bolt (Not included)

Designation	Applicable cutter	Available cutters
CB0525	MAPD040HR/L-Z4	Ø40
CB1025	MAPD050HR/L-Z5	Ø50
	MAPD063HR/L-Z6	Ø63

Parts

Specification	Insert screw	Adjust screw	Balance screw	Wrench for insert	Adjust wrench
Ø32~Ø63	FTKA0408	AHX0617F-NYLOK	KHD0405	TW15S	HW20L

Available inserts E24 Available arbors and bolt E426~E428

E PCD Face Cutter

Code system

PDF 6 032 - HSK63A

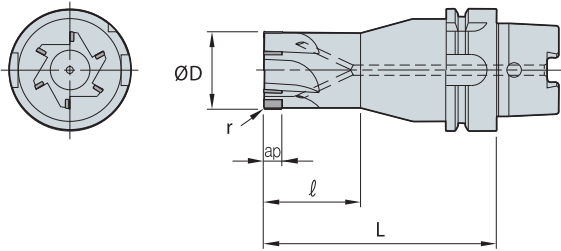
PCD Face cutter

Tooth

Diameter

Shank

PCD Face cutter



AA
90°
• AR: 6°
• RR: 5°~9°

(mm)

Designation		$\varnothing D$	r	ap	ℓ	L	
PDF	4032-HSK50A	4	32	0.5	8	120	
	4040-HSK50A	4	40	0.5	8	120	
	4032-HSK63A	4	32	0.5	8	120	
	4040-HSK63A	4	40	0.5	8	120	
	4050-HSK63A	4	50	0.5	8	120	
	6063-HSK63A	6	63	0.5	12	-	100
	6063-HSK100A	6	63	0.5	12	-	100

Recommended cutting condition

Workpiece	vc (m/min)	fz (mm/t)	ap (mm)
Al, Brass, Alloy	200~2,000	0.02~0.1	0.05~4.0

Special PCD order sheet

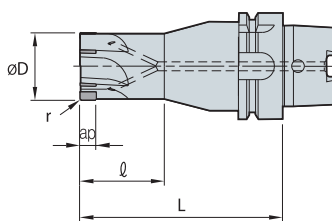
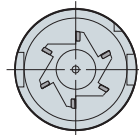


Fig. 1

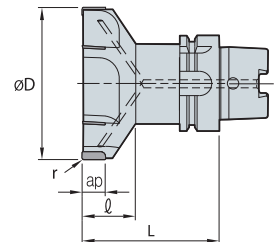


Fig. 2

Designation	Fig.	tooth	Dimensions (mm)					Shank spec.
			$\varnothing D$	r	ap	ℓ	L	
PDF								



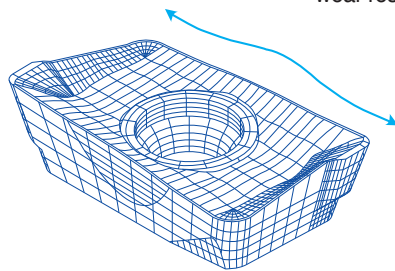
Various applications are available with multi-functional cutters

Alpha Mill

- Innovative curve cutting-edge and chip-breaker design ensures ideal 90-degree cutting, lower cutting resistance, and improved insert life.
- Various applications are available with multi-functional cutters. (Facing, Slotting, Square shoulder milling, etc.)
- Excellent performance ensured at large depth of cut operations due to strong cutting-edge and low cutting resistance.

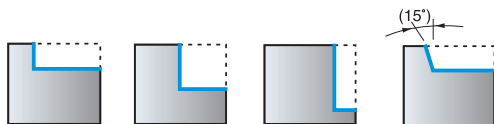
Features of insert

- Long tool life at high speed, high feed and deeper cutting by low cutting resistance and strong cutting-edge
- Distinguished features of Alpha-Curve reduce cutting resistance and improve cutting-edge strength and wear resistance
- Low cutting resistance is realized by KORLOY unique design-the alpha curve cutting-edge and optimal convex and concave design
- Highly efficient machining is available by the ideal application of the grade to material



Application example

Shouldering



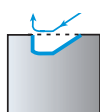
Slotting



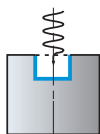
Drilling



Ramping



Helical cutting

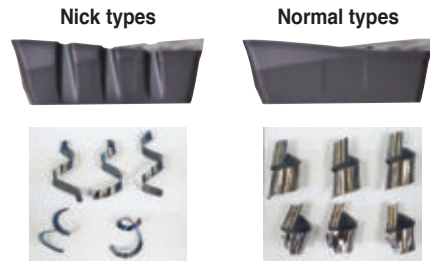


Alpha Mill Nick new

- New nick cutting edge reduces cutting load
- High productivity
- APMT standard holders are compatible with Alpha Mill nick that is reducing stock management cost.




Features

- Lower cutting load due to the overlapping system



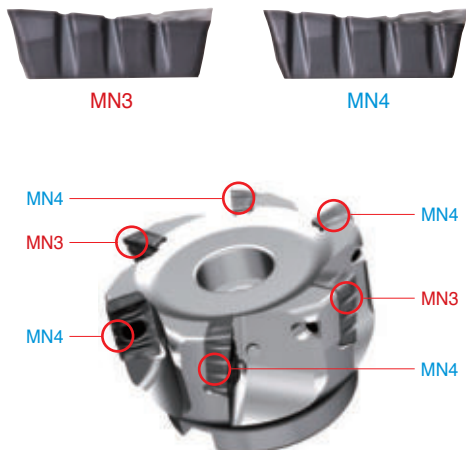
※ Nick types require both chip breaker types for application.

※ Can be used with the existing Alpha Mill holders. Use multi-edges for maximum results. (cutters with even-numbered teeth)

Type	Nick type		General type
Required No. of teeth	20		20
For AMCM3080M (4 Flute x 5 teeth)	 x 10 APMT16-MN3	 x 10 APMT16-MN4	 x 20 APMT16-MM, MF, ML, MA

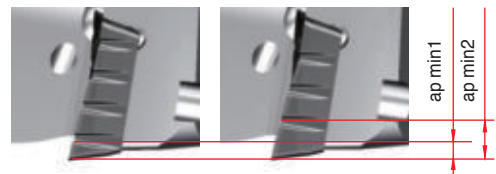
How to clamp

- Alternate the two types of chip breakers when clamping an insert.



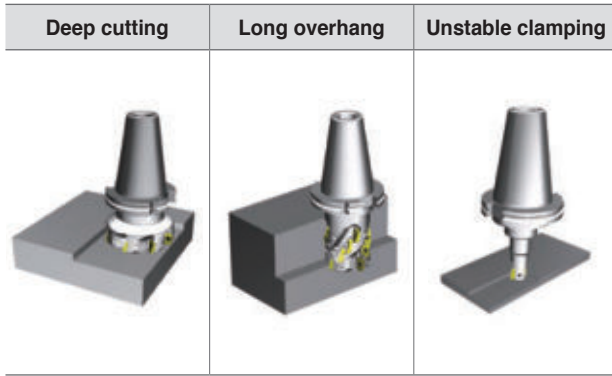
Min. depth of cut

- The depth of cut must be greater than ap_{min1} for chip breaking.

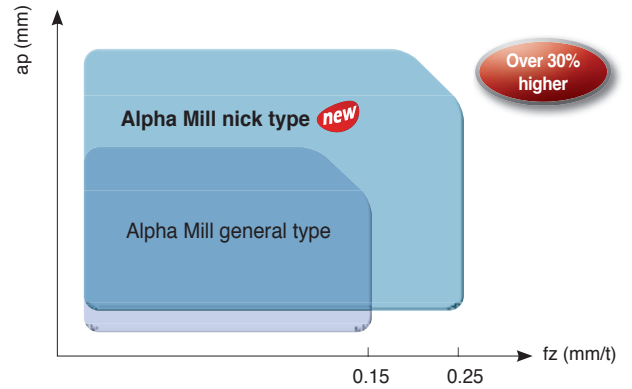


Type	ap_{min1}	ap_{min2}
APMT11 (2000 type)	1.6 mm	4.1 mm
APMT16 (3000 type)	2.2 mm	5 mm
APMT18 (4000 type)	2.3 mm	5.5 mm

Application examples



Application area



• 30% or higher cutting conditions available compared to normal types

Recommended cutting condition

ISO	Grades	APMT 2000 type			APMT 3000 type			APMT 4000 type		
		vc (m/min)	fz (mm/t)	ap (mm)	vc (m/min)	fz (mm/t)	ap (mm)	vc (m/min)	fz (mm/t)	ap (mm)
P	PC3700	180~280	0.05~0.15	11	160~270	0.05~0.18	16	160~270	0.05~0.18	17
	PC5300	150~250	0.05~0.15		150~240	0.05~0.18		150~240	0.05~0.18	
M	PC5300	90~170	0.05~0.15		90~150	0.05~0.18		90~150	0.05~0.18	
K	PC5300	120~240	0.1~0.2		120~200	0.1~0.23		120~200	0.1~0.23	

※ Above cutting conditions can be applied up to cutting speed of 300 m/min and feed per tooth of 0.4 mm/t.

Features of chip breakers

Insert	Cutting-edge	Uses	Features
MA		Al	Optimal cutting-edge and buffed surface for aluminum workpieces ensure high performance in machining
ML		Hard-to-cut material	Chip breaker with low cutting load is optimal for machining hard-to-cut materials
MF		Light cutting	Chip breaker with low cutting load and harder cutting-edge than ML's are optimal for light cutting
MM		General cutting	Optimal for milling in general ranges
MN		Roughing (Nick)	Design for easy chip cutting ensures high machinability in toughing

Product constitution

Item description	Type	Nose R	MA	ML	
APMT	1000 type	0.4	APMT0602PDFR-MA	-	
		0.8	APMT060208PDFR-MA	-	
	1500 type	0.4	APMT0903PDFR-MA	APMT0903PDER-ML	
		0.8	APMT090308PDFR-MA	APMT090308PDER-ML	
	2000 type	0.5	APMT11T3PDFR-MA	APMT11T3PDER-ML	
		0.8	APMT11T308PDFR-MA	APMT11T308PDER-ML	
	3000 type	0.4	APMT160404PDFR-MA	APMT160404PDER-ML	
		0.8	APMT1604PDFR-MA	APMT1604PDER-ML	
	4000 type	0.4	APMT180604PDFR-MA	APMT180604PDER-ML	
		0.8	APMT1806PDFR-MA	APMT1806PDER-ML	
		1.2	APMT180612PDFR-MA	APMT180612PDER-ML	
		1.6	APMT180616PDFR-MA	APMT180616PDER-ML	
		2.0	APMT180620PDFR-MA	APMT180620PDER-ML	
		2.4	APMT180624PDFR-MA	APMT180624PDER-ML	
			3.0	APMT180630R-MA	APMT180630R-ML

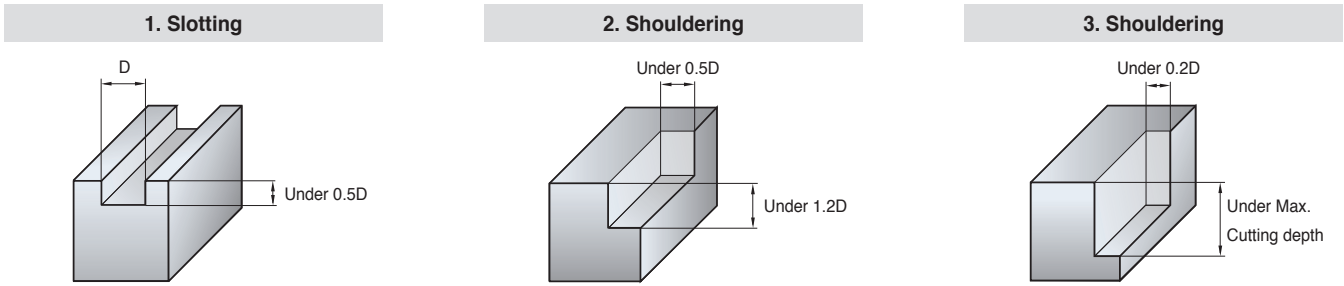
- The inserts can switch to the APMT type holders.

Recommended grades and chip breakers by workpiece

Chip breaker	Cutter edge	Recommended C/B and grade as per workpiece (●: 1 st)											
		P				M		K		N		S	
		Low carbon steel/Mild steel		High carbon steel/Mild steel		Stainless steel		Cast iron		Aluminum alloy		Ti/Inconel	
		C/B	Grades	C/B	Grades	C/B	Grades	C/B	Grades	C/B	Grades	C/B	Grades
MA		-	-	-	-	-	-	-	-	●	●H01	-	-
ML		-	-	-	-	●	● PC5300 ○ PC5400 ○ PC9530	-	-	-	-	●	● PC5300 ○ PC5400
MF		●	● PC3700 ○ PC5300 ○ PC5400 ○ NCM325 ○ NCM335	-	○ PC3700 ○ NCM325 ○ NCM335	-	● PC5300 ○ PC5400 ○ PC9530	-	● PC6510 ○ PC5300 ○ PC5400	-	-	-	● PC5300 ○ PC5400
MM		-	● PC3700 ○ PC5300 ○ PC5400 ○ NCM325 ○ NCM335	●	● PC3700 ○ PC5300 ○ PC5400 ○ NCM325 ○ NCM335	-	● PC5300 ○ PC5400 ○ PC9530	●	● PC6510 ○ PC5300 ○ PC5400	-	-	-	● PC5300 ○ PC5400
MN		-	● PC3700 ○ PC5300 ○ PC5400	-	-	-	● PC5300 ○ PC5400 ○ PC9530	-	● PC6510 ○ PC5300 ○ PC5400	-	-	-	● PC5300 ○ PC5400



➤ Recommended depth of cut



➤ Recommended cutting condition (for Multi-edge type)

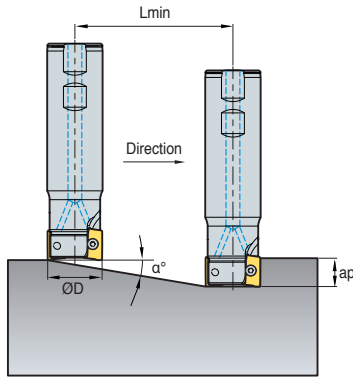
Workpiece	Grades	Fig.	Tool dia.									
			Ø10, 16		Ø20, 25		Ø32, 40		Ø50, 63		Ø80, 100	
			vc (m/min)	fz (mm/t)	vc (m/min)	fz (mm/t)	vc (m/min)	fz (mm/t)	vc (m/min)	fz (mm/t)	vc (m/min)	fz (mm/t)
Mild steel, Low carbon steel)	NCM535 NCM325 PC5400 PC5300 PC3700	①	50~80	0.05~0.08	80~100	0.05~0.08	100~120	0.05~0.08	100~120	0.05~0.08	100~120	0.05~0.08
		②	65~90	0.08~0.1	100~120	0.08~0.1	120~140	0.08~0.1	120~140	0.08~0.1	120~140	0.08~0.1
		③	65~95	0.1~0.15	100~120	0.1~0.15	120~140	0.1~0.15	120~140	0.1~0.15	130~150	0.1~0.15
High carbon steel, Alloy steel	NCM535 NCM325 PC5300 PC3700	①	45~60	0.05	60~80	0.05	80~100	0.05	80~100	0.05	80~100	0.05
		②	50~80	0.05~0.08	80~100	0.05~0.08	100~120	0.08~0.1	100~120	0.08~0.1	100~120	0.08~0.1
		③	50~80	0.1~0.15	80~100	0.1~0.15	110~130	0.1~0.15	100~120	0.1~0.15	110~130	0.1~0.15
Alloy tool steel	PC5300 PC3700 PC2510 PC2505	①	40~55	0.05	50~70	0.05	70~90	0.05	70~90	0.05	70~90	0.05
		②	45~60	0.05~0.08	60~80	0.05~0.08	90~120	0.05~0.08	100~120	0.05~0.08	100~120	0.05~0.08
		③	50~75	0.12~0.18	90~110	0.12~0.18	100~130	0.1~0.15	100~120	0.1~0.15	110~130	0.1~0.15
Stainless steel	PC5300 PC9530	①	35~50	0.054	50~70	0.054	70~90	0.05	70~90	0.05	70~90	0.05
		②	45~60	0.05~0.08	60~80	0.05~0.08	90~120	0.05~0.08	100~120	0.05~0.08	100~120	0.05~0.08
		③	50~75	0.1~0.15	90~110	0.1~0.15	100~130	0.1~0.15	110~130	0.1~0.15	110~130	0.1~0.15
Cast iron	PC6510 PC5300	①	50~70	0.1~0.12	70~90	0.1~0.12	70~90	0.1~0.12	90~120	0.1~0.12	90~120	0.1~0.12
		②	50~80	0.12	80~100	0.12	90~120	0.12	100~140	0.12	100~140	0.12
		③	50~80	0.15~0.2	80~100	0.15~0.2	100~130	0.15~0.2	120~150	0.15~0.2	120~150	0.15~0.2
Aluminum alloy	H01	①	160~600	0.1~0.2	200~800	0.1~0.2	300~900	0.1~0.2	400~1,000	0.1~0.2	400~1,000	0.1~0.2
		②	200~650	0.15~0.3	250~900	0.15~0.3	300~950	0.15~0.3	400~1,000	0.1~0.4	400~1,000	0.1~0.4
		③	200~650	0.15~0.3	250~900	0.15~0.3	300~950	0.15~0.3	400~1,000	0.1~0.4	400~1,000	0.1~0.4
Hardened steel	PC5300 PC2510 PC2505	①	35~50	0.03	50~70	0.03	60~90	0.03	60~90	0.03	60~90	0.03
		②	45~60	0.05~0.08	60~80	0.05~0.08	80~100	0.05~0.08	80~100	0.05~0.08	80~100	0.05~0.08
		③	50~80	0.05~0.08	80~100	0.05~0.08	80~100	0.05~0.08	80~100	0.05~0.08	80~100	0.05~0.08

➤ Recommended cutting condition (for Single-edge type)

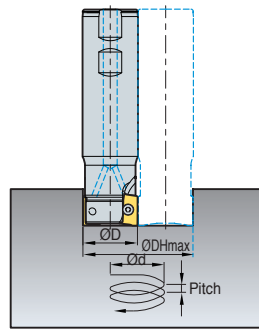
Workpiece	Grades	Fig.	Tool dia.									
			Ø10, 16		Ø20, 25		Ø32, 40		Ø50, 63		Ø80, 100	
			vc (m/min)	fz (mm/t)	vc (m/min)	fz (mm/t)	vc (m/min)	fz (mm/t)	vc (m/min)	fz (mm/t)	vc (m/min)	fz (mm/t)
Mild steel, low carbon steel	NCM535 NCM325 PC5400 PC5300 PC3700	①	45~60	0.05~0.08	60~80	0.05~0.08	80~120	0.05~0.08	120~200	0.05~0.08	150~200	0.05~0.08
		②	60~90	0.08~0.1	80~120	0.08~0.1	120~180	0.08~0.1	180~250	0.08~0.1	200~250	0.08~0.1
		③	60~90	0.1~0.15	80~120	0.1~0.15	120~180	0.1~0.15	180~250	0.1~0.15	200~250	0.1~0.15
High carbon steel, alloy steel	NCM535 NCM325 PC5300 PC3700	①	40~60	0.05	50~80	0.05	80~110	0.05	100~150	0.05	100~150	0.05
		②	50~80	0.05~0.08	80~100	0.05~0.08	110~150	0.05~0.1	150~200	0.05~0.1	150~200	0.05~0.1
		③	50~80	0.1~0.15	80~100	0.1~0.15	120~150	0.1~0.15	180~200	0.1~0.15	180~200	0.1~0.15
Alloy tool steel	PC5300 PC3700 PC2510 PC2505	①	35~50	0.05	50~70	0.05	80~100	0.05	100~130	0.05	100~130	0.05
		②	45~70	0.05~0.08	70~100	0.05~0.08	100~130	0.05~0.1	130~180	0.05~0.1	130~180	0.05~0.1
		③	45~70	0.1~0.15	70~100	0.1~0.15	100~150	0.1~0.15	130~180	0.1~0.15	130~180	0.1~0.15
Stainless steel	PC5300 PC9530	①	35~50	0.05	50~70	0.05	80~100	0.05	100~130	0.05	100~130	0.05
		②	45~70	0.05~0.08	70~100	0.05~0.08	100~130	0.05~0.1	130~180	0.05~0.1	130~180	0.05~0.1
		③	45~70	0.1~0.15	70~100	0.1~0.15	100~150	0.1~0.15	130~180	0.1~0.15	130~180	0.1~0.15
Cast iron	PC6510 PC5300	①	50~80	0.08~0.12	80~100	0.08~0.12	80~100	0.15	120~150	0.15	120~150	0.15
		②	65~90	0.12~0.15	100~120	0.12~0.15	100~130	0.15~0.18	150~200	0.15~0.18	150~200	0.15~0.18
		③	65~90	0.15~0.2	100~120	0.15~0.2	100~130	0.15~0.2	150~200	0.15~0.2	150~200	0.15~0.2
Aluminum alloy	H01	①	200~600	0.15~0.2	250~800	0.15~0.2	300~900	0.15~0.2	400~1,000	0.1~0.2	400~1,000	0.1~0.2
		②	200~650	0.2~0.25	250~900	0.2~0.25	350~950	0.2~0.25	400~1,000	0.2~0.3	400~1,000	0.2~0.3
		③	200~650	0.25~0.3	250~900	0.25~0.3	350~950	0.25~0.3	400~1,000	0.3~0.4	400~1,000	0.3~0.4
Hardened steel	PC5300 PC2510 PC2505	①	35~50	0.03	50~70	0.03	60~90	0.03	60~90	0.03	60~90	0.03
		②	45~65	0.05~0.08	60~80	0.05~0.08	80~100	0.05~0.08	80~100	0.05~0.08	80~100	0.05~0.08
		③	50~80	0.05~0.08	80~100	0.05~0.08	80~100	0.05~0.08	80~100	0.05~0.08	80~100	0.05~0.08

➤ Cutting condition for ramping and helical operation

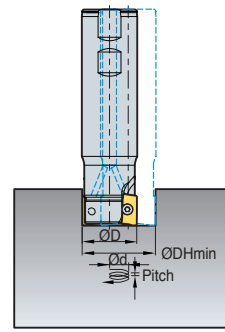
1. Ramping



2. Helical cutting for blind hole



3. Helical cutting for through hole



(mm)

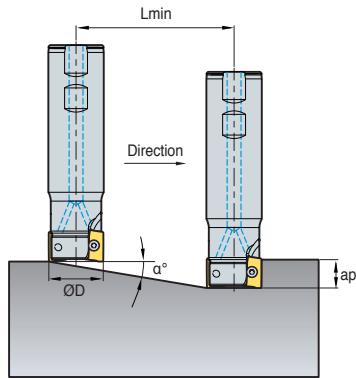
Designation	Tool dia. ØD (min)	ap	1. Ramping		2. Helical cutting for blind hole			3. Helical cutting for through hole		
			Maximum angle α(°)	Lmin	Min. desirable hole dia. ØDHmin	Max. pitch dmax	Max. desirable hole dia. ØDHmax	Max. pitch dmax	Min. desirable hole dia. ØDHmin	Max. pitch dmax
AMS1010HS	10	5	6.5	44	17.6	2.0	18.8	2.1	13	1.5
AMS1011HS	11		5.6	51	19.6	1.9	20.8	2.0	15	1.5
AMS1012HS	12		4.9	58	21.6	1.9	22.8	2.0	17	1.5
AMS1014HS	14		3.9	73	25.6	1.8	26.8	1.8	21	1.4
AMS1015HS	15		3.6	80	27.6	1.7	28.8	1.8	23	1.4
AMS1016HS	16		3.3	87	29.6	1.7	30.8	1.8	25	1.4
AMS1017HS	17		3.0	94	31.6	1.7	32.8	1.7	27	1.4
AMS1018HS	18		2.8	101	33.6	1.7	34.8	1.7	29	1.4
AMS1020HS	20		2.5	115	37.6	1.6	38.8	1.7	33	1.4
AMS1021HS	21		2.3	123	39.6	1.6	40.8	1.7	35	1.4
AMS1022HS	22		2.2	130	41.6	1.6	42.8	1.6	37	1.4
AMS1025HS	25		1.9	151	47.6	1.6	48.8	1.6	43	1.4
AMS1026HS	26		1.8	158	49.6	1.6	50.8	1.6	45	1.4
AMS1032HS	32		1.4	201	61.6	1.5	62.8	1.6	57	1.4
AMS1033HS	33		1.4	208	63.6	1.5	64.8	1.6	59	1.4
AMCM1032HS	32		1.4	201	61.6	1.5	62.8	1.6	57	1.4
AMCM1040HS	40		1.1	258	77.6	1.5	78.8	1.5	73	1.4
AMCM1050HS	50		0.9	330	97.6	1.5	98.8	1.5	93	1.4
AMCM1063HS	63	0.7	423	123.6	1.5	124.8	1.5	119	1.4	
AMS1510HS	10	9	7.5	68	17.4	2.3	18.8	2.5	11	1.5
AMS1512HS	12		6.5	79	21.4	2.4	22.8	2.6	15	1.7
AMS1513HS	13		5.7	90	23.4	2.3	24.8	2.5	17	1.7
AMS1514HS	14		6.3	82	25.4	2.8	26.8	2.9	19	2.1
AMS1516HS	16		5.0	102	29.4	2.6	30.8	2.7	23	2.0
AMS1517HS	17		4.6	112	31.4	2.5	32.8	2.6	25	2.0
AMS1518HS	18		4.2	122	33.4	2.5	34.8	2.6	27	2.0
AMS1519HS	19		3.9	132	35.4	2.4	36.8	2.5	29	2.0
AMS1520HS	20		3.6	142	37.4	2.4	38.8	2.5	31	2.0
AMS1521HS	21		3.4	152	39.4	2.3	40.8	2.4	33	2.0
AMS1522HS	22		3.2	162	41.4	2.3	42.8	2.4	35	1.9
AMS1524HS	24		2.8	182	45.4	2.2	46.8	2.3	39	1.9
AMS1525HS	25		2.7	192	47.4	2.2	48.8	2.3	41	1.9
AMS1528HS	28		2.3	222	53.4	2.2	54.8	2.2	47	1.9
AMS1530HS	30		2.1	242	57.4	2.1	58.8	2.2	51	1.9
AMS1532HS	32		2.0	262	61.4	2.1	62.8	2.2	55	1.9
AMS1535HS	35		1.8	292	67.4	2.1	68.8	2.1	61	1.9
AMS1540HS	40		1.5	342	77.4	2.0	78.8	2.1	71	1.9
AMCM15040HS	40		1.5	342	77.4	2.0	78.8	2.1	71	1.9
AMCM15050HS	50		1.2	442	97.4	2.0	98.8	2.0	91	1.9
AMCM15063HS	63		0.9	572	123.4	1.9	124.8	2.0	117	1.8
AMCM15080HS	80		0.7	742	157.4	1.9	158.8	1.9	151	1.8
AMCM15100HS	100		0.5	942	197.4	1.9	198.8	1.9	191	1.8

$$Lmin = \frac{ap}{\tan \alpha} \text{ (mm)}$$

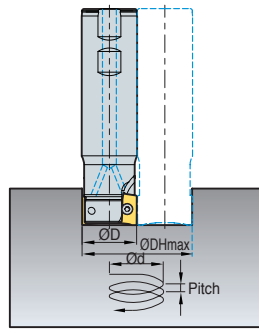


➤ Cutting condition for ramping and helical operation

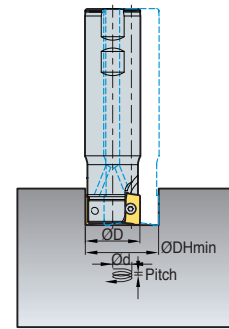
1. Ramping



2. Helical cutting for blind hole



3. Helical cutting for through hole

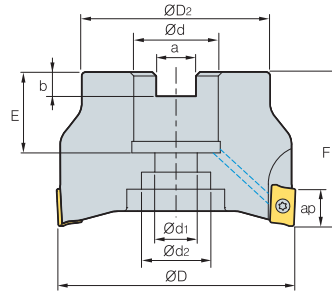


(mm)

Designation	Tool dia. ØD (min)	ap	1. Ramping		2. Helical cutting for blind hole				3. Helical cutting for through hole		
			Maximum angle α(°)	Lmin	Min. desirable hole dia. ØDHmin	Max. pitch dmax	Max. desirable hole dia. ØDHmax	Max. pitch dmax	Min. desirable hole dia. ØDHmin	Max. pitch dmax	
AMS2010HS	10	10	16.82	33	16.4	5.0	18	5.4	11	3.3	
AMS2012HS	12		11.69	48	20.4	4.2	22	4.6	15	3.1	
AMS2014HS	14		7.55	75	24.4	3.2	26	3.4	19	2.5	
AMS2016HS	16		10.30	55	28	5.1	30	5.5	23	4.2	
AMS2018HS	18		8.23	69	32	4.6	34	4.9	27	3.9	
AMS2020HS	20		5.60	102	36	3.5	38	3.7	31	3.0	
AMS2022HS	22		5.15	111	40	3.6	42	3.8	35	3.2	
AMS2025HS	25		3.92	146	46	3.2	48	3.3	41	2.8	
AMS2032HS	32		2.70	212	60	2.8	62	2.9	55	2.6	
AMS2040HS	40		1.98	289	76	2.6	78	2.7	71	2.5	
AMS2050HS	50		1.48	386	96	2.5	98	2.5	91	2.4	
AMS2063HS	63		1.11	514	122	2.4	124	2.4	117	2.3	
AMCM2040HS	40		1.29	445	76	2.5	78	2.6	71	2.1	
AMCM2050HS	50		0.36	1576	96	0.6	98	0.6	91	0.6	
AMCM2063HS	63		0.27	2104	122	0.6	124	0.6	117	0.6	
AMCM2080HS	80		0.21	2784	156	0.6	158	0.6	151	0.5	
AMCM2100HS	100		0.16	3584	196	0.5	198	0.6	191	0.5	
AMS3025HS	25		10	4.72	121	46	3.8	48	4.0	36	3.0
AMS3032HS	32			3.00	191	60	3.1	62	3.2	50	2.6
AMS3040HS	40			2.29	250	76	3.0	78	3.1	66	2.6
AMS3050HS	50	1.64		350	96	2.7	98	2.8	86	2.5	
AMS3063HS	63	1.22		470	122	2.6	124	2.6	112	2.4	
AMCM3040HS	40	1.99		288	76	2.6	78	2.7	66	2.3	
AMCM3050HS	50	1.67		343	96	2.8	98	2.9	86	2.5	
AMCM3063HS	63	1.22		470	122	2.6	124	2.6	112	2.4	
AMCM3080HS	80	0.90		636	156	2.5	158	2.5	146	2.3	
AMCM3100HS	100	0.69		830	196	2.4	198	2.4	186	2.2	
AMS2025MH	25	10	1.50	764	46	1.2	48	1.3	-	-	
AMS2032MH	32		1.50	1146	60	1.6	62	1.6	-	-	
AMS3040MH	40	16	1.50	1528	76	2.0	78	2.0	-	-	
AMS4020HS	20	16	9.5	98	37.4	6.2	38.8	6.5	31	5.2	
AMS4021HS	21		5.2	179	39.4	3.6	40.8	3.7	33	3.0	
AMS4025HS	25		7.6	122	47.4	6.3	48.8	6.5	41	5.5	
AMS4026HS	26		7.1	130	49.4	6.2	50.8	6.4	43	5.4	
AMS4032HS	32		3.4	276	61.4	3.6	62.8	3.7	55	3.3	
AMS4033HS	33		3.2	288	63.4	3.6	64.8	3.7	57	3.2	
AMS4040HS	40		2.5	376	77.4	3.4	78.8	3.4	71	3.1	
AMS4050HS	50		1.9	502	97.4	3.2	98.8	3.2	91	3.0	
AMS4063HS	63		1.4	665	123.4	3.0	124.8	3.1	117	2.9	
AMCM4050HS	50		1.9	502	97.4	3.2	98.8	3.2	91	3.0	
AMCM4063HS	63		1.4	665	123.4	3.0	124.8	3.1	117	2.9	
AMCM4080HS	80		1.1	878	157.4	2.9	158.8	2.9	151	2.8	
AMCM4100HS	100		0.8	1128	197.4	2.9	198.8	2.9	191	2.8	
AMCM4125HS	125		0.6	1442	247.4	2.8	248.8	2.8	241	2.7	

$$Lmin = \frac{ap}{\tan \alpha} \text{ (mm)}$$

AMC(M)1000S



AA
90°
• AR: 9°~13°
• RR: -14°~5°

(mm)

Designation	⊙	ØD	ØD2	Ød	Ød1	Ød2	a	b	E	F	ap	$\frac{m}{kg}$	
AMCM	1032HS	8	32	30	16	9	14	8.4	5.6	19	40	5.6	0.15
	1040HS-16	10	40	34	16	9	14	8.4	5.6	19	40	5.6	0.24
	1040HS-22	10	40	34	22	11	18	10.4	6.3	21	40	5.6	0.24
	1050HS	12	50	42	22	11	18	10.4	6.3	21	40	5.6	0.36
	1063HS	14	63	49	22	11	18	10.4	6.3	21	40	5.6	0.61

Available inserts

APMT-MA APMT-MM



Designation	Cermet		Coated										Uncoated		page			
	CN2500	CN30	NC5330	NCM325	NCM335	NCM535	NCM545	PC2505	PC2510	PC3700	PC6510	PC9530	PC9540	PC5300		PC5400	G10	H01
APMT	0602PDFR-MA																	●
	060208PDFR-MA																	
	060202PDSR-MM			●						●				●	●			
	0602PDSR-MM			●				●	●	●	●			●	●			
	060208PDSR-MM			●						●				●	●			
	060212R-MM			●										●	●			
	060216R-MM													●	●			

Available arbors

Designation	Ød	NC arbors
AMCM	1032HS	BT□□-FMC16-□□
	1040HS-16	
	1040HS-22	
	1050HS	BT□□-FMC22-□□
	1063HS	

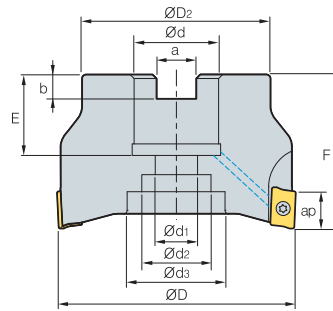
Parts

Specification	Screw	Wrench
Ø32~Ø63	FTKA01842	TW06S-A

Available inserts E05 Available arbors and bolt E426~E428



AMC(M)1500S



AA 90°
 • AR: 9°~13°
 • RR: -14°~5°

(mm)

Designation	⊙	ØD	ØD2	Ød	Ød1	Ød2	Ød3	a	b	E	F	ap	kg	
AMCM	15040HS	5	40	34	16	9	14	-	8.4	5.6	19	40	9	0.22
	15050HS	6	50	42	22	11	18	-	10.4	6.3	21	40	9	0.34
	15063HS	8	63	49	22	11	18	-	10.4	6.3	21	40	9	0.57
AMC (AMCM)	15080HS	10	80	57	25.4 (27)	14	25	35	9.5 (12.4)	6 (7)	24 (23)	50	9	1.10
	15100HS	12	100	67	31.75 (32)	18	26	42	12.7 (14.4)	8 (8)	32 (26)	63	9	2.10

()Metric size

Available inserts

APMT-MA APMT-ML APMT-MM



Designation	Cermet		Coated											Uncoated		page		
	CN2500	CN80	NC5330	NCM825	NCM835	NCM835	NCM645	PC2505	PC2510	PC3700	PC6510	PC9530	PC9540	PC6300	PC5400		G10	H01
APMT 0903PDFR-MA																	●	E05
090308PDFR-MA																		
0903PDER-ML														●	●			
090308PDER-ML														●	●			
0903PDSR-MM			●					●	●	●	●			●	●			
090308PDSR-MM			●							●				●	●			
090312R-MM										●				●	●			
090316R-MM			●							●				●	●			
090320R-MM										●				●	●			

Available arbors

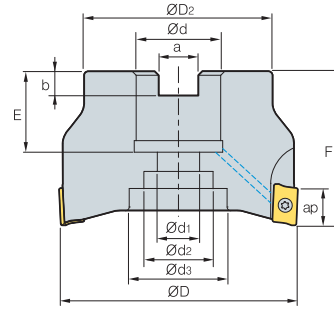
Designation	Ød	NC arbors
AMCM 15040HS	16	BT□□-FMC16-□□
15050HS	22	BT□□-FMC22-□□
15063HS		
AMC (AMCM) 15080HS	25.4	BT□□-FMA25.4-□□
	27	BT□□-FMC27-□□
15100HS	31.75	BT□□-FMA31.75-□□
	32	BT□□-FMC32-□□

Parts

Specification	Screw	Wrench
Ø40~Ø100	FTKA02565S	TW08S

Available inserts E05 Available arbors and bolt E426~E428

AMC(M)2000S



Designation	⊙	ØD	ØD2	Ød	Ød1	Ød2	Ød3	a	b	E	F	ap	$\frac{m}{kg}$	
AMCM	2040HS	5	40	34	16	9	14	-	8.4	5.6	18	40	11	0.22
	2050HS	6	50	42	22	11	18	-	10.4	6.3	20	40	11	0.34
	2063HS	8	63	49	22	11	18	-	10.4	6.3	20	40	11	0.57
AMC (AMCM)	2080HS	8	80	57	25.4 (27)	14	25	35	9.5 (12.4)	6 (7)	25 (22)	50	11	1.10
	2100HS	10	100	67	31.75 (32)	18	26	42	12.7 (14.4)	8 (8)	32 (28)	63	11	2.10

() Metric size

Available inserts



Designation	Cermet		Coated										Uncoated		page			
	CN2500	CN30	NC5330	NCM325	NCM335	NCM535	NCM545	PC2505	PC2510	PC3700	PC6510	PC9530	PC9540	PC5300		PC5400	G10	H01
APMT	11T3PDFR-MA																●	E06
	11T308PDFR-MA																	
	11T3PDER-ML													●	●			
	11T308PDER-ML													●	●			
	11T3PDSR-MM			●	●		●	●	●	●	●			●	●			
	11T3PDSR-MF			●					●	●				●	●			
	11T308PDSR-MM			●					●		●	●		●	●			
	11T312PDSR-MM			●					●		●			●	●			
	11T316R-MM			●					●					●	●			
	11T318R-MM			●					●					●	●			
	11T324R-MM			●					●					●	●			
	11T3PDSR-MN2													●				
	11T3PDSR-MN3													●				

* Please purchase 2 types of APMT-MN (nick type) inserts with different chip breakers. * Please use the cutters with even teeth.

Available arbors

Designation	Ød	NC arbors	
AMCM	2040HS	16	BT□□-FMC16-□□
	2050HS	22	BT□□-FMC22-□□
	2063HS		
AMC (AMCM)	2080HS	25.4	BT□□-FMA25.4-□□
		27	BT□□-FMC27-□□
		31.75	BT□□-FMA31.75-□□
	2100HS	32	BT□□-FMC32-□□

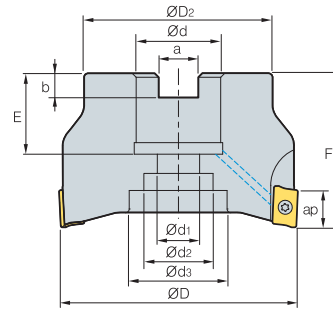
Parts

Specification	Screw	Wrench
Ø40~Ø100	FTKA02565S	TW08S

Available inserts E06 Available arbors and bolt E426-E428



AMC(M)3000S



AA
90°
• AR: 14°
• RR: -12°~8°

(mm)

Designation	Teeth	ØD	ØD2	Ød	Ød1	Ød2	Ød3	a	b	E	F	ap	$\frac{m}{kg}$	
AMCM	3040HS	4	40	34	16	9	14	-	8.4	5.6	18	40	16	0.18
	3050HS	5	50	42	22	11	18	-	10.4	6.3	20	40	16	0.28
	3063HS	6	63	49	22	11	18	-	10.4	6.3	20	40	16	0.50
AMC (AMCM)	3080HS	7	80	57	25.4 (27)	14	25	35	9.5 (12.4)	6 (7)	25 (22)	50	16	1.02
	3100HS	8	100	67	31.75 (32)	18	26	42	12.7 (14.4)	8 (8)	32 (28)	63	16	2.05

()Metric size

Available inserts



Designation	Cermet		Coated											Uncoated		page		
	CN2500	CN80	NC5330	NCM325	NCM335	NCM535	NCM545	PC2505	PC2510	PC3700	PC6510	PC9530	PC9540	PC5300	PC5400		G10	H01
APMT	1604PDFR-MA																●	E06
	160404PDFR-MA																	
	1604PDER-ML																	
	160404PDER-ML													●	●			
	1604PDSR-MM			●	●		●	●	●	●	●	●	●	●	●			
	1604PDSR-MF			●					●	●				●	●			
	160410PDSR-MM								●					●	●			
	160416PDSR-MM			●					●					●	●			
	160424R-MM			●					●					●	●			
	160430R-MM			●					●					●	●			
	160432R-MM			●					●					●	●			
	1604PDSR-MN3													●				
	1604PDSR-MN4													●				

※ Please purchase 2 types of APMT-MN (nick type) inserts with different chip breakers. ※ Please use the cutters with even teeth.

Available arbors

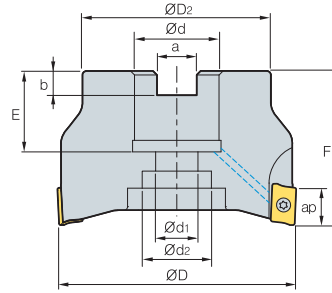
Designation	Ød	NC arbors	
AMCM	3040HS	16	BT□□-FMC16-□□
	3050HS	22	BT□□-FMC22-□□
	3063HS		
AMC (AMCM)	3080HS	25.4	BT□□-FMA25.4-□□
		27	BT□□-FMC27-□□
	3100HS	31.75	BT□□-FMA31.75-□□
		32	BT□□-FMC32-□□

Parts

Specification	Screw	Wrench
Ø40-Ø100	FTKA0410	TW15S

Available inserts E06 Available arbors and bolt E426~E428

AMC(M)3000S-K



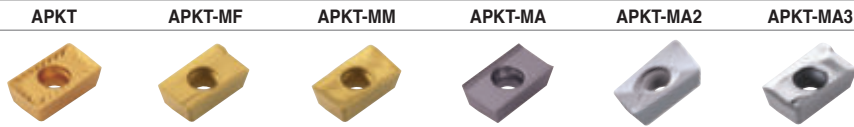
AA
90°
• AR: 14°
• RR: -12°~8°

(mm)

Designation		ØD	ØD2	Ød	Ød1	Ød2	a	b	E	F	ap		
AMCM	3040HS-K	4	40	34	16	9	14	8.4	5.6	18	40	16	0.15
	3050HS-K	5	50	42	22	11	18	10.4	6.3	20	40	16	0.24
	3063HS-K	6	63	49	22	11	18	10.4	6.3	20	40	16	0.24
AMC (AMCM)	3080HS-K	7	80	57	25.4 (27)	14	20	9.5 (12.4)	6 (7)	25 (22)	50	16	0.36
	3100HS-K	8	100	67	31.75 (32)	18	26	12.7 (14.4)	8 (8)	32 (28)	63	16	0.61

() Metric size

Available inserts



Designation	Cermet		Coated											Uncoated			page	
	CN2500	CN30	NCM325	NCM335	NCM635	NCM545	PC2505	PC2510	PC3700	PC6510	PC9530	PC9540	PC5300	PC5400	PD2000	G10		H01
APKT 1604PDSR			●						●	●								
1604PDSR-MF			●										●					
1604PDSR-MM			●	●					●	●	●		●					
1604PDFR-MA														●			●	●
1604PDFR-MA2																	●	
160416FR-MA2																	●	
160432FR-MA2																	●	
1604PDFR-MA3																●	●	●
160420FR-MA3																		

E04

Available arbors

Designation	Ød	NC arbors
AMCM 3040HS-K	16	BT□□-FMC16-□□
3050HS-K	22	BT□□-FMC22-□□
3063HS-K		
AMC (AMCM)	25.4	BT□□-FMA25.4-□□
	27	BT□□-FMC27-□□
	31.75	BT□□-FMA31.75-□□
3100HS-K	32	BT□□-FMC32-□□

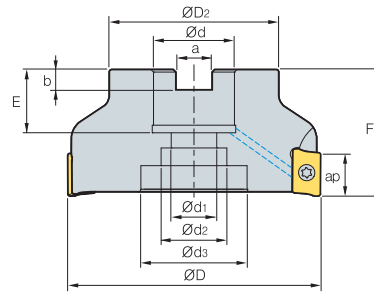
Parts

Specification		
Ø40~Ø100	FTKA0410	TW15S

Available inserts E04 Available arbors and bolt E426~E428



AMC(M)4000S



AA 90°
 •AR: 13°~15°
 •RR: -12°~7°

(mm)

Designation	Teeth	ØD	ØD2	Ød	Ød1	Ød2	Ød3	a	b	E	F	ap	kg	
AMCM 4050HS	5	50	42	22	11	18	-	10.4	6.3	21	40	17	0.28	
	6	63	49	22	11	18	-	10.4	6.3	21	40	17	0.50	
AMC (AMCM)	4080HS	7	80	57	25.4 (27)	14	25	35	9.5 (12.4)	6 (7)	24 (23)	50	17	1.00
	4100HS	8	100	67	31.75 (32)	18	26	42	12.7 (14.4)	8 (8)	32 (25)	63 (50)	17	2.10
	4125HS	9	125	87	38.1 (40)	22	32	52	15.9 (16.4)	10 (9)	35 (29)	63	17	3.30
	4160S	10	160	107	50.8 (40)	-	-	100	19 (16.4)	11 (9)	38 (32)	63	17	3.6
	4200S	10	200	108	47.625 (60)	-	-	132	25.4 (25.7)	14 (14)	40 (38)	63	17	6

() Metric size

Available inserts



Designation	Coated										Uncoated		page	Designation	Coated										Uncoated		page																																									
	CN2500	CN30	NC5330	NCM325	NCM335	NCM535	NCM545	PC2505	PC2010	PC3700	PC6510	PC9530			PC9540	PC5300	PC5400	G10	H01	CN2500	CN30	NC5330	NCM325	NCM335	NCM535	NCM545		PC2505	PC2510	PC3700	PC6510	PC9530	PC9540	PC5300	PC5400	G10	H01																															
APMT 1806PDR-MA																																		APMT 180624PDR-ML																																		
180604PDR-MA																																			180630R-ML																																	
180612PDR-MA																																				1806PDSR-MM																																
180616PDR-MA																																				1806PDSR-MF																																
180620PDR-MA																																				180612PDSR-MM																																
180624PDR-MA																																				180616PDSR-MM																																
180630R-MA																																				180620PDSR-MM																																
1806PDR-ML																																				180624PDSR-MM																																
180604PDR-ML																																				180630R-MM																																
180612PDR-ML																																				180632R-MM																																
180616PDR-ML																																				1806PDSR-MN3																																
180620PDR-ML																																				1806PDSR-MN4																																

※ Please purchase 2 types of APMT-MN (nick type) inserts with different chip breakers. ※ Please use the cutters with even teeth.

Available arbors

Designation	Ød	NC arbors
AMCM 4050HS	22	BT□□-FMC22-□□
4063HS		
AMC (AMCM) 4080HS	25.4	BT□□-FMA25.4-□□
4100HS	27	BT□□-FMC27-□□
	31.75	BT□□-FMA31.75-□□
	32	BT□□-FMC32-□□

Designation	Ød	NC arbors
AMC (AMCM) 4125HS	38.1	BT□□-FMA38.1-□□
	40	BT□□-FMC40-□□
4160S	50.8	BT□□-FMA50.8-□□
	40	BT□□-FMC40-□□
4200S	47.625	BT□□-FMA47.625-□□
	60	BT□□-FMB60-□□

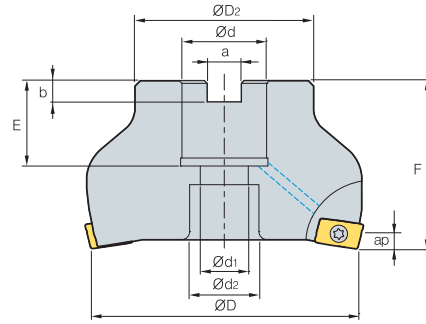
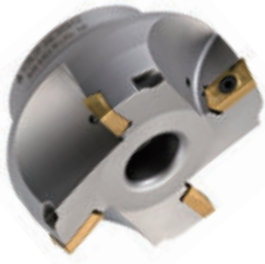
Parts

Specification	Screw	Wrench
Ø50~Ø200	FTKA0410	TW15S

Available inserts E06 Available arbors and bolt E426~E428



AMC(M)1000SE/2000SE



AA
75°

• AR: 45°
• RR: 0°

(mm)

Designation		ØD	ØD2	Ød	Ød1	Ød2	a	b	E	F	ap	
AMCM 1040HSE	4	40	34	16	9	14	8.4	5.6	19	40	2.5	0.26
	5	50	42	22	11	18	10.4	6.3	21	40	2.5	0.39
AMC (AMCM) 2080HSE	5	80	57	25.4 (27)	14	20	9.5 (12.4)	6.0 (7.0)	25 (22)	50	4	1.2
	6	100	67	31.75 (32)	18	26	12.7 (14.4)	8.0 (8.0)	32 (28)	63	4	2.33

()Metric size

Available inserts

APMT-MM APMT-MF



Type	Designation	Cermet		Coated										Uncoated		page		
		CN2500	CN30	NC5330	NCM325	NCM335	NCM535	NCM545	PC2505	PC2510	PC3700	PC6510	PC9530	PC9540	PC5300		PC5400	G10
1000 type	APMT 060202PDSR-MM			●							●				●	●		
	0602PDSR-MM			●					●	●	●	●	●		●	●		
	060208PDSR-MM			●							●				●	●		
	060212R-MM			●											●	●		
2000 type	APMT 11T3PDSR-MM			●	●		●		●	●	●	●	●		●	●		
	11T3PDSR-MF			●						●	●				●	●		
	11T308PDSR-MM			●						●		●	●		●	●		
	11T312PDSR-MM			●						●		●			●	●		
	11T316R-MM			●						●					●	●		
	11T318R-MM			●						●					●	●		
	11T324R-MM			●						●					●	●		

E06

Available arbors

Type	Designation	Ød	NC arbors
1000 type	AMC (AMCM) 1040HSE	16	BT□□-FMC16-□□
	1050HSE	22	BT□□-FMC22-□□
2000 type	AMC (AMCM) 2080HSE	25.4	BT□□-FMA25.4-□□
		27	BT□□-FMC27-□□
	2100HSE	31.75	BT□□-FMA31.75-□□
		32	BT□□-FMC32-□□

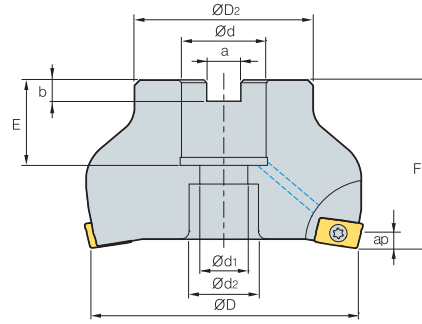
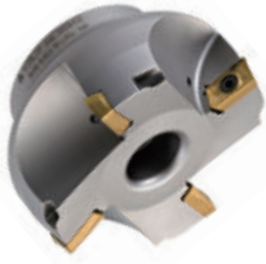
Parts

Specification			
Ø40~Ø50 (1000 type)	FTKA01842	-	TW06S-A
Ø80~Ø100 (2000 type)	FTKA02565S	TW08S	-

Available inserts E06 Available arbors and bolt E426-E428



AMC(M)3000SE



Designation			ØD	ØD ₂	Ød	Ød ₁	Ød ₂	a	b	E	F	ap	
AMC (AMCM)	3080HSE	4	80	57	25.4 (27)	14	20	9.5 (12.4)	6.0 (7.0)	25 (22)	50	6	1.3
	3100HSE	5	100	67	31.75 (32)	18	26	12.7 (14.4)	8.0 (8.0)	32 (28)	63	6	2.3

(mm)

() Metric size

Available inserts

APMT-MM APMT-MF



Designation	Cermet		Coated											Uncoated		page		
	CN2500	CN30	NC5330	NCM325	NCM335	NCM535	NCM545	PC2505	PC2510	PC3700	PC6510	PC9530	PC9540	PC5300	PC5400		G10	H01
APMT 1604PDSR-MM			●	●		●		●	●	●	●	●	●	●	●			E06
1604PDSR-MF			●							●	●			●	●			
160410PDSR-MM										●				●	●			
160416PDSR-MM			●							●				●	●			
160424R-MM			●							●				●	●			
160430R-MM										●				●	●			
160432R-MM			●							●				●	●			

Available arbors

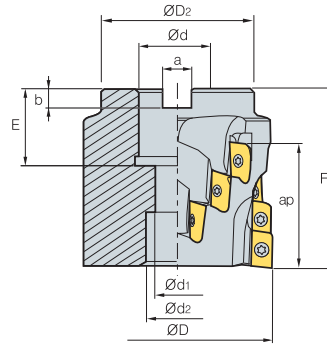
Designation	Ød	NC arbors
AMC (AMCM) 3080HSE	25.4	BT□□-FMA25.4-□□
	27	BT□□-FMC27-□□
3100HSE	31.75	BT□□-FMA31.75-□□
	32	BT□□-FMC32-□□

Parts

Specification		
Ø80-Ø100	FTKA0410	TW08S

Available inserts **E06** Available arbors and bolt **E426-E428**

AMC(M)2000M



(mm)

Designation	Symbol	ØD	ØD ₂	Ød	Ød ₁	Ød ₂	a	b	E	F	No. of flute	ap	kg	
AMCM 2050M		16	50	40	22	11	18	10.4	6.3	21	58	4	39	0.7
AMC (AMCM) 2063M		16	63	50	25.4 (27)	13.5	20	9.5 (12.4)	6 (7)	25 (25)	58	4	39	0.8
2080M		20	80	60	31.75 (32)	-	45	12.7 (14.4)	8 (8)	35 (28)	63	5	39	0.96
2100M		24	100	80	38.1 (40)	-	56	15.9 (16.4)	10 (9)	38 (30)	63	6	39	1.2

() Metric size

Available inserts



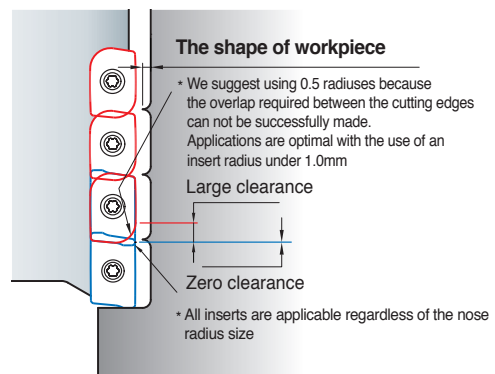
Designation	Cermet		Coated										Uncoated		page			
	CN2500	CN80	NC5330	NCM325	NCM335	NCM535	NCM545	PC2505	PC2510	PC3700	PC6510	PC9530	PC9540	PC5300		PC5400	G10	H01
APMT 11T3PDFR-MA																		●
11T308PDFR-MA																		
11T3PDER-ML														●	●			
11T308PDER-ML														●	●			
11T3PDSR-MM			●	●		●		●	●		●	●		●	●			
11T3PDSR-MF			●					●	●		●	●		●	●			
11T308PDSR-MM			●					●	●		●	●		●	●			
11T312PDSR-MM			●					●	●		●	●		●	●			
11T316R-MM			●					●	●		●	●		●	●			
11T318R-MM			●					●	●		●	●		●	●			
11T324R-MM			●					●	●		●	●		●	●			
11T3PDSR-MN2														●	●			
11T3PDSR-MN3														●	●			

※ Please purchase 2 types of APMT-MN (nick type) inserts with different chip breakers. ※ Please use the cutters with even teeth.

Available arbors

Designation	Ød	NC arbors	
AMC 2050M	22	BT□□-FMC22-□□	BT□□-SMC22-□□
AMC (AMCM) 2063M	25.4	BT□□-FMA25.4-□□	BT□□-SMA25.4-□□
	27	BT□□-FMC27-□□	BT□□-SMC27-□□
2080M	31.75	BT□□-FMA31.75-□□	BT□□-SMA31.75-□□
	32	BT□□-FMC32-□□	BT□□-SMC32-□□
2100M	38.1	BT□□-FMA38.1-□□	BT□□-SMA38.1-□□
	40	BT□□-FMC40-□□	BT□□-SMC40-□□

Caution when clamping the inserts



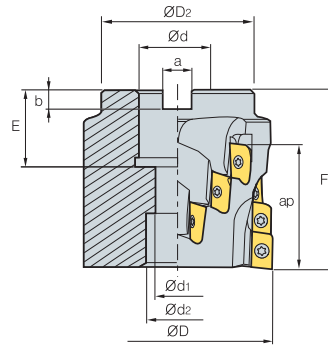
Parts

Specification	Screw	Wrench
Ø50~Ø100	FTKA02565S	TW08S

Available inserts E06 Available arbors and bolt E426-E428



AMC(M)3000M



AA
90°

- AR: 9°
- RR: -9°~5°

(mm)

Designation	ØD	ØD2	Ød	Ød1	Ød2	a	b	E	F	No. of flute	ap	
AMC 3063M	63	57	25.4 (27)	14	20	9.5 (12.4)	6 (7)	38 (38)	85	4	57	1.1
(AMCM) 3080M	80	67	31.75 (32)	14	26	12.7 (14.4)	8 (8)	40 (40)	100	4	71	2.23
3100M	100	87	38.1 (40)	22	32	15.9 (16.4)	10 (9)	40 (40)	100	6	71	3.59

()Metric size

Available inserts



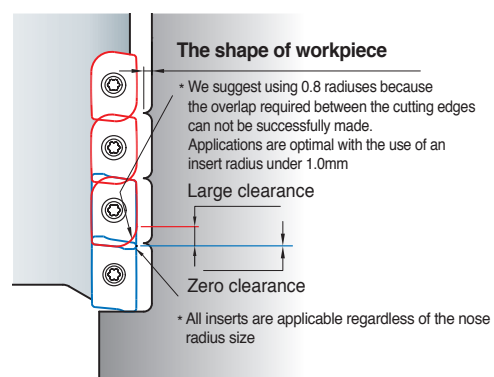
Designation	Cermet		Coated										Uncoated		page					
	CN2500	CN30	NC5330	NCM325	NCM335	NCM335	NCM335	NCM335	NCM335	PC2505	PC2510	PC3700	PC6510	PC9530		PC9540	PC5300	PC5400	G10	H01
APMT 1604PDFR-MA																				
160404PDFR-MA																				
1604PDER-ML																				
160404PDER-ML																				
1604PDSR-MM				●	●		●	●	●	●	●	●	●	●	●	●	●			
1604PDSR-MF				●																
160410PDSR-MM																				
160416PDSR-MM				●																
160424R-MM				●																
160430R-MM																				
160432R-MM				●																
1604PDSR-MN3																				
1604PDSR-MN4																				

※ Please purchase 2 types of APMT-MN (nick type) inserts with different chip breakers. ※ Please use the cutters with even teeth.

Available arbors

Designation	Ød	NC arbors	
AMC (AMCM) 3063M	25.4	BT□□-FMA25.4-□□	BT□□-SMA25.4-□□
	27	BT□□-FMC27-□□	BT□□-SMC27-□□
3080M	31.75	BT□□-FMA31.75-□□	BT□□-SMA31.75-□□
	32	BT□□-FMC32-□□	BT□□-SMC32-□□
3100M	38.1	BT□□-FMA38.1-□□	BT□□-SMA38.1-□□
	40	BT□□-FMC40-□□	BT□□-SMC40-□□

Caution when clamping the inserts

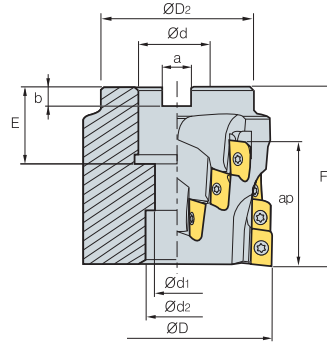


Parts

Specification		
Ø63-Ø100	FTKA0410	TW15S

Available inserts **E06** Available arbors and bolt **E426~E428**

AMC(M)4000M



(mm)

Designation	ØD	ØD2	Ød	Ød1	Ød2	a	b	E	F	No. of flute	ap	kg		
AMC	4063M	16	63	57	25.4 (27)	14	20	9.5 (12.4)	6 (7)	38 (38)	85	4	61.1	1.1
(AMCM)	4080M	20	80	67	31.75 (32)	14	26	12.7 (14.4)	8 (8)	40 (40)	100	4	76.1	2.23
	4100M	30	100	87	38.1 (40)	22	32	15.9 (16.4)	10 (9)	40 (40)	100	6	76.1	3.59
	4125M	18	125	87	38.1 (40)	22	32	15.9 (16.4)	10 (9)	36 (29)	68	6	46.1	4.0

()Metric size

Available inserts



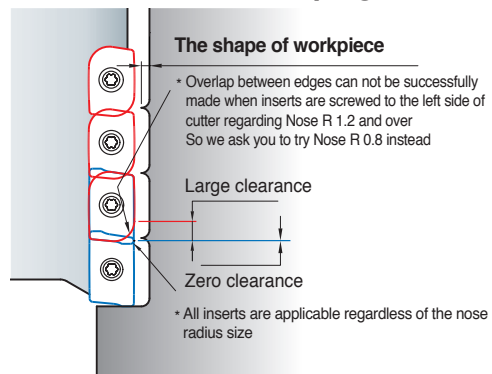
Designation	Coated							page	Designation	Coated							page													
	CN2500	CN30	NCM325	NCM335	NCM535	PC2505	PC2010			PC3700	PC6510	PC9530	PC9540	PC5300	PC5400	G10		H01	Designation	CN2500	CN30	NCM325	NCM335	NCM535	PC2505	PC2510	PC3700	PC6510	PC9530	PC9540
APMT 1806PDR-MA									E06	APMT 180624PDR-ML									E06											
180604PDR-MA										180630R-ML																				
180612PDR-MA										1806PDSR-MM																				
180616PDR-MA										1806PDSR-MF																				
180620PDR-MA										180612PDSR-MM																				
180624PDR-MA										180616PDSR-MM																				
180630R-MA										180620PDSR-MM																				
1806PDER-ML										180624PDSR-MM																				
180604PDER-ML										180630R-MM																				
180612PDER-ML										180632R-MM																				
180616PDER-ML										1806PDSR-MN3																				
180620PDER-ML										1806PDSR-MN4																				

* Please purchase 2 types of APMT-MN (nick type) inserts with different chip breakers. * Please use the cutters with even teeth.

Available arbors

Designation	Ød	NC arbors	
AMC (AMCM)	4063M	BT□□-FMA25.4-□□	BT□□-SMA25.4-□□
		BT□□-FMC27-□□	BT□□-SMC27-□□
4080M	31.75	BT□□-FMA31.75-□□	BT□□-SMA31.75-□□
	32	BT□□-FMC32-□□	BT□□-SMC32-□□
4100M	38.1	BT□□-FMA38.1-□□	BT□□-SMA38.1-□□
	40	BT□□-FMC40-□□	BT□□-SMC40-□□
4125M	38.1	BT□□-FMA38.1-□□	BT□□-SMA38.1-□□
	40	BT□□-FMC40-□□	BT□□-SMC40-□□

Caution when clamping the inserts



Parts

Specification	Screw	Wrench
Ø63~Ø125	FTKA0410	TW15S

Available inserts E06 Available arbors and bolt E426~E428



AMS1000S

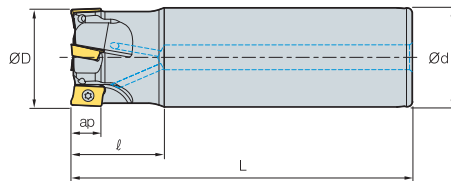


Fig. 1

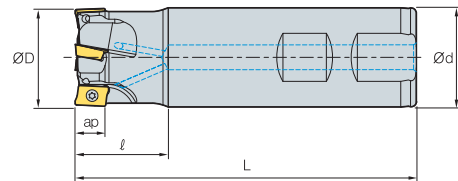


Fig. 2



AA
90°

• AR: 7.5°~13°
• RR: -17°~6°

(mm)

Designation		ØD	Ød	ℓ	L	ap		Fig.
AMS								
1010HS	2	10	10	20	80	5.6	0.04	2
1011HS	2	11	10	20	80	5.6	0.04	2
1012HS-2	2	12	12	25	80	5.6	0.06	2
1012HS-2L12	2	12	12	25	120	5.6	0.09	1
1012HS-3	3	12	12	25	80	5.6	0.06	2
1014HS-2	2	14	16	25	90	5.6	0.11	2
1014HS-2L16	2	14	16	25	140	5.6	0.18	1
1014HS-3	3	14	16	25	90	5.6	0.11	2
1015HS	3	15	16	25	90	5.6	0.11	2
1015HS-3L16	3	15	16	25	140	5.6	0.18	1
1016HS-3	3	16	16	25	90	5.6	0.12	2
1016HS-3L16	3	16	16	25	160	5.6	0.22	1
1016HS-4	4	16	16	25	90	5.6	0.12	2
1017HS	4	17	16	25	90	5.6	0.12	2
1017HS-3L16	3	17	16	25	160	5.6	0.22	1
1018HS	4	18	16	25	90	5.6	0.12	2
1018HS-4L16	4	18	16	25	180	5.6	0.25	1
1020HS-4	4	20	20	30	110	5.6	0.23	2
1020HS-4L20	4	20	20	30	200	5.6	0.43	1
1020HS-5	5	20	20	30	110	5.6	0.23	2
1021HS	5	21	20	30	110	5.6	0.24	2
1021HS-4L20	4	21	20	30	200	5.6	0.43	1
1022HS	5	22	20	30	110	5.6	0.27	2
1025HS	7	25	25	30	120	5.6	0.39	2
1026HS	7	26	25	30	120	5.6	0.39	2
1032HS	8	32	32	35	120	5.6	0.65	2
1033HS	8	33	32	35	120	5.6	0.65	2

Available inserts

APMT-MA APMT-MM



Designation	Cermet		Coated											Uncoated		page		
	CN2500	CN80	NC5330	NCM825	NCM835	NCM535	NCM545	PC2505	PC2510	PC3700	PC6510	PC9530	PC9540	PC5300	PC5400		G10	H01
APMT																	●	E06
0602PDFR-MA																		
060208PDFR-MA																		
060202PDSR-MM			●							●				●	●			
0602PDSR-MM			●					●	●	●	●	●		●	●			
060208PDSR-MM			●							●				●	●			
060212R-MM			●											●	●			
060216R-MM														●	●			

Parts

Specification		
Ø10~Ø33	FTKA01842	TW06S-A

Available inserts E06

AMS1500S

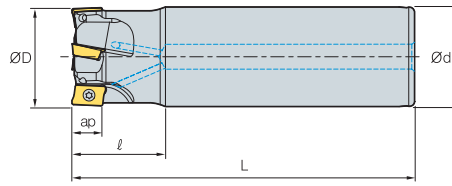


Fig. 1

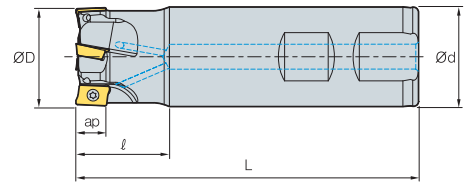


Fig. 2



AA
90°
• AR: 7.5°~12.5°
• RR: -28°~14°

(mm)

Designation		ØD	Ød	ℓ	L	ap		Fig.
AMS 15010HS	1	10	10	25	80	9	0.04	2
15010HS-1L16	1	10	16	30	160	9	0.21	1
15012HS	1	12	16	25	80	9	0.10	2
15012HS-1L16	1	12	16	30	160	9	0.21	1
15013HS	1	13	16	25	80	9	0.10	2
15014HS	1	14	16	25	80	9	0.10	2
15014HS-1L16	1	14	16	30	160	9	0.21	1
15016HS	2	16	16	30	90	9	0.11	2
15016HS-2L16	2	16	16	30	160	9	0.21	1
15017HS	2	17	16	30	90	9	0.12	2
15017HS-2L16	2	17	16	30	160	9	0.21	1
15018HS	2	18	16	30	90	9	0.14	2
15018HS-2L16	2	18	16	30	160	9	0.21	1
15019HS	2	19	16	30	90	9	0.16	2
15020HS	2	20	20	30	90	9	0.18	2
15020HS-2L20	2	20	20	30	160	9	0.34	1
15020HS-3	3	20	20	30	90	9	0.18	2
15021HS	2	21	20	30	90	9	0.20	2
15021HS-2L20	2	21	20	30	160	9	0.34	1
15021HS-3	3	21	20	30	90	9	0.20	2
15022HS	3	22	20	30	110	9	0.23	2
15022HS-3L20	3	22	20	30	180	9	0.38	1
15024HS	3	24	20	30	110	9	0.30	2
15024HS-4	4	24	20	30	110	9	0.30	2
15025HS-3S20	3	25	20	30	110	9	0.35	2
15025HS	3	25	25	30	110	9	0.35	2
15025HS-3L25	3	25	25	30	180	9	0.59	1

Available inserts

APMT-MA APMT-ML APMT-MM



Designation	Cermet		Coated										Uncoated		page			
	CN2500	CN30	NC5330	NCM325	NCM325	NCM635	NCM645	PC2505	PC2510	PC3700	PC6510	PC9530	PC9540	PC5300		PC5400	G10	H01
APMT 0903PDFR-MA																	●	E06
090308PDFR-MA																		
0903PDER-ML														●	●			
090308PDER-ML														●	●			
0903PDSR-MM			●					●	●	●	●			●	●			
090308PDSR-MM			●							●	●			●	●			
090312R-MM										●	●			●	●			
090316R-MM			●							●	●			●	●			
090320R-MM										●	●			●	●			

Parts

Specification		
Ø10~Ø14	FTKA02555S	TW08S
Ø16~Ø25	FTKA02565S	

Available inserts E06



AMS1500S

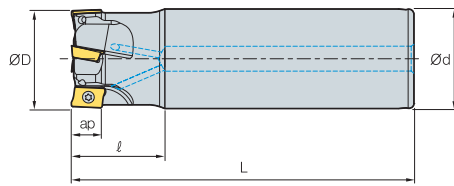


Fig. 1

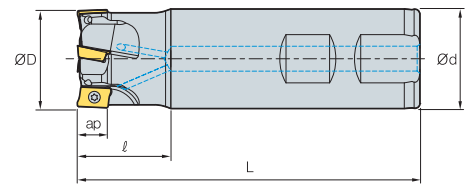


Fig. 2



AA
90°
• AR: 7.5°~12.5°
• RR: -28°~-14°

(mm)

Designation		ØD	Ød	ℓ	L	ap		Fig.
AMS 15025HS-4S20	4	25	20	30	110	9	0.25	2
15025HS-4S25	4	25	25	30	110	9	0.25	2
15028HS	4	28	25	30	110	9	0.36	2
15028HS-4L25	4	28	25	30	180	9	0.61	1
15028HS-5	5	28	25	30	110	9	0.36	2
15030HS	4	30	25	30	110	9	0.38	2
15030HS-4L25	4	30	25	30	180	9	0.62	1
15030HS-5	5	30	25	30	110	9	0.38	2
15032HS	4	32	32	30	110	9	0.60	2
15032HS-4L32	4	32	32	30	180	9	1.00	1
15032HS-5	5	32	32	30	110	9	0.60	2
15035HS	5	35	32	30	110	9	0.70	2
15035HS-6	6	35	32	30	110	9	0.70	2
15040HS-S32	5	40	32	35	130	9	0.80	2
15040HS-5L32	5	40	32	35	200	9	1.20	1
15040HS-6S32	6	40	32	35	130	9	0.80	2
15040HS-S40	5	40	40	35	130	9	1.13	2
15040HS-6S40	6	40	40	35	130	9	1.13	2
15040HS-S42	5	40	42	35	130	9	1.23	2
15040HS-6S42	6	40	42	35	130	9	1.23	2

Available inserts

APMT-MA APMT-ML APMT-MM



Designation	Cermet		Coated											Uncoated		page		
	CN2500	CN30	NC5330	NCM225	NCM335	NCM535	NCM545	PC2505	PC2510	PC3700	PC6510	PC9530	PC9540	PC5300	PC5400		G10	H01
APMT 0903PDFR-MA																	●	E06
090308PDFR-MA																		
0903PDER-ML														●	●			
090308PDER-ML														●	●			
0903PDSR-MM			●					●	●	●	●			●	●			
090308PDSR-MM			●							●	●			●	●			
090312R-MM										●	●			●	●			
090316R-MM			●							●	●			●	●			
090320R-MM										●	●			●	●			

Parts

Specification		
Ø25~Ø40	FTKA02565S	TW08S

Available inserts E06

AMS2000S

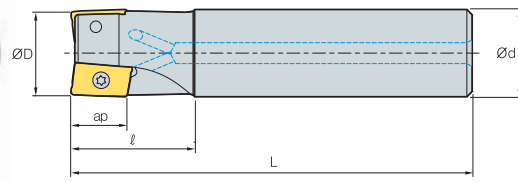


Fig. 1

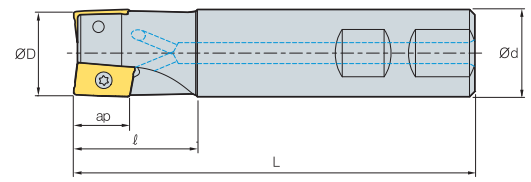


Fig. 2



AA
90°

• AR: 3°~14°
• RR: -25°~18°

(mm)

Designation		ØD	Ød	ℓ	L	ap		Fig.
AMS 2010HS	1	10	10	20	85	11	0.04	2
2010HS-1L16	1	10	16	30	160	11	0.21	1
2012HS	1	12	16	25	85	11	0.10	2
2012HS-1L16	1	12	16	30	160	11	0.21	1
2014HS	1	14	16	25	90	11	0.12	2
2014HS-1L16	1	14	16	30	160	11	0.21	1
2016HS	2	16	16	25	90	11	0.12	2
2016HS-2L16	2	16	16	30	180	11	0.21	1
2018HS	2	18	16	25	90	11	0.12	2
2018HS-2L16	2	18	16	30	180	11	0.21	1
2020HS	2	20	20	30	100	11	0.21	2
2020HS-2L20	2	20	20	30	210	11	0.49	1
2022HS	3	22	20	35	115	11	0.25	2
2022HS-3L20	3	22	20	35	180	11	0.38	1
2025HS	3	25	25	35	115	11	0.40	2
2025HS-3L25	3	25	25	40	180	11	0.59	1
2032HS	4	32	32	40	125	11	0.70	2
2032HS-4L32	4	32	32	50	180	11	1.00	1
2040HS	5	40	32	42	130	11	0.84	2
2040HS-5L32	5	40	32	50	200	11	1.20	1
2040HS-S40	5	40	40	42	130	11	1.15	2
2040HS-S42	5	40	42	42	130	11	2.00	2
2050HS	6	50	32	45	135	11	1.06	2
2050HS-S40	6	50	40	45	135	11	1.38	2
2050HS-S42	6	50	42	45	135	11	1.50	2
2063HS	8	63	32	45	135	11	1.31	2
2063HS-S40	8	63	40	45	135	11	1.62	2
2063HS-S42	8	63	42	45	135	11	1.70	2

Available inserts



Designation	Cermet		Coated										Uncoated		page			
	CN2500	CN30	NC5330	NCM325	NCM335	NCM535	NCM545	PC2505	PC2510	PC3700	PC6510	PC9530	PC9540	PC5300		PC5400	G10	H01
APMT 11T3PDFR-MA																		●
11T308PDFR-MA																		
11T3PDER-ML														●	●			
11T308PDER-ML														●	●			
11T3PDSR-MM			●	●		●	●	●	●	●	●	●	●	●	●			
11T3PDSR-MF			●					●	●		●			●	●			
11T308PDSR-MM			●					●	●		●	●	●	●	●			
11T312PDSR-MM			●					●	●		●	●	●	●	●			
11T316R-MM			●					●	●		●	●	●	●	●			
11T318R-MM			●					●	●		●	●	●	●	●			
11T324R-MM			●					●	●		●	●	●	●	●			
11T3PDSR-MN2														●	●			
11T3PDSR-MN3														●	●			

Parts

* Please purchase 2 types of APMT-MN (nick type) inserts with different chip breakers. * Please use the cutters with even teeth.

Specification		
Ø10-Ø14	FTKA02555S	TW08S
Ø16-Ø63	FTKA02565S	



AMS3000S

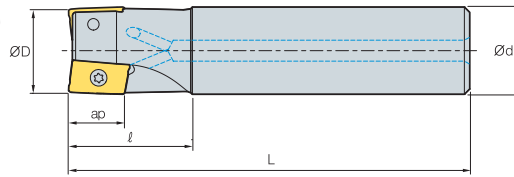


Fig. 1

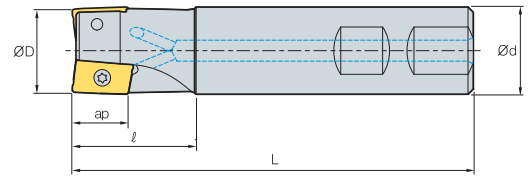


Fig. 2



• AR: 3°~14°
• RR: -18°~-10°

(mm)

Designation		ØD	Ød	ℓ	L	ap		Fig.
AMS 3025HS	2	25	25	35	115	16	0.40	2
3025HS-2M25	2	25	25	35	180	16	0.65	1
3025HS-2L25	2	25	25	60	220	16	0.75	1
3032HS	3	32	32	40	125	16	0.69	2
3032HS-2M32	2	32	32	40	200	16	1.13	1
3032HS-2L32	2	32	32	65	260	16	1.52	1
3032HS-3M32	3	32	32	40	200	16	1.12	1
3032HS-3L32	3	32	32	65	260	16	1.48	1
3040HS	4	40	32	42	130	16	0.80	2
3040HS-3M32	3	40	32	42	200	16	1.24	1
3040HS-3L32	3	40	32	42	260	16	1.61	1
3040HS-4M32	4	40	32	42	200	16	1.21	1
3040HS-4L32	4	40	32	42	260	16	1.58	1
3040HS-S40	4	40	40	42	130	16	1.10	2
3040HS-S42	4	40	42	42	130	16	1.20	2
3050HS	5	50	32	45	135	16	1.00	2
3050HS-S40	5	50	40	45	135	16	1.30	2
3050HS-S42	5	50	42	45	135	16	1.40	2
3063HS	6	63	32	45	135	16	1.25	2
3063HS-S40	6	63	40	45	135	16	1.50	2
3063HS-S42	6	63	42	45	135	16	1.54	2

Available inserts



Designation	Cermet		Coated										Uncoated		page			
	CN2500	CN30	NC5330	NCM325	NCM335	NCM535	NCM545	PC2505	PC2510	PC3700	PC6510	PC9530	PC9540	PC5300		PC5400	G10	H01
APMT 1604PDFR-MA																		●
160404PDFR-MA																		
1604PDER-ML																		
160404PDER-ML																		
1604PDSR-MM			●	●		●		●	●	●	●	●	●	●	●			
1604PDSR-MF			●						●	●				●	●			
160410PDSR-MM										●				●	●			
160416PDSR-MM										●				●	●			
160424R-MM			●							●				●	●			
160430R-MM										●				●	●			
160432R-MM			●							●				●	●			
1604PDSR-MN3														●	●			
1604PDSR-MN4														●	●			

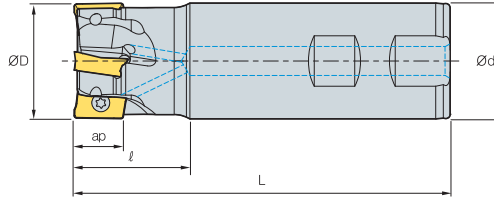
※ Please purchase 2 types of APMT-MN (nick type) inserts with different chip breakers. ※ Please use the cutters with even teeth.

Parts

Specification		
Ø25 Ø32-Ø63	FTKA0408 FTKA0410	TW15S

Available inserts E06

AMS3000S-K

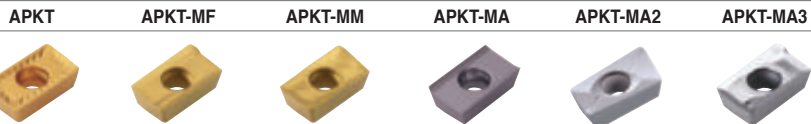


AA
90°
• AR: 14°
• RR: -18°~10°

(mm)

Designation		ØD	Ød	l	L	ap	
AMS 3025HS-K	2	25	25	35	115	16	0.4
3032HS-K	3	32	32	40	125	16	0.69
3040HS-K	4	40	32	42	130	16	0.8
3040HS-K-S40	4	40	40	42	130	16	1.1
3040HS-K-S42	4	40	42	42	130	16	1.2
3050HS-K	5	50	32	45	135	16	1.0
3050HS-K-S40	5	50	40	45	135	16	1.3
3050HS-K-S42	5	50	42	45	135	16	1.4
3063HS-K	6	63	32	45	135	16	1.25
3063HS-K-S40	6	63	40	45	135	16	1.5
3063HS-K-S42	6	63	42	45	135	16	1.54

Available inserts



Designation	Cermet		Coated												Uncoated			page
	CN2500	CN30	NCM325	NCM335	NCM635	NCM645	PC2505	PC2510	PC3700	PC6510	PC9530	PC9540	PC5300	PC5400	PD2000	G10	H01	
APKT 1604PDSR			●						●	●								
1604PDSR-MF			●										●					
1604PDSR-MM			●	●					●	●	●		●					
1604PDFR-MA														●			●	●
1604PDFR-MA2																	●	
160416FR-MA2																	●	
160432FR-MA2																	●	
1604PDFR-MA3															●	●	●	

Parts

Specification		
Ø25 Ø32-Ø63	FTKA0408 FTKA0410	TW15S

Available inserts E04



AMS4000S

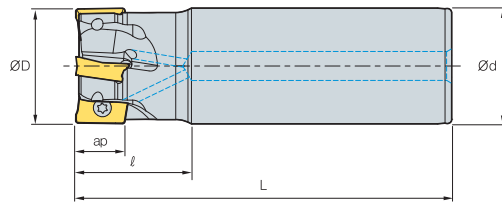


Fig. 1

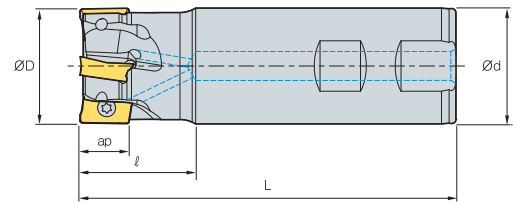


Fig. 2



(mm)

Designation		ØD	Ød	ℓ	L	ap		Fig.
AMS 4020HS	1	20	20	30	90	17	0.18	2
4020HS-M	1	20	20	30	160	17	0.17	1
4021HS	1	21	20	30	90	17	0.19	2
4021HS-M	1	21	20	30	160	17	0.34	1
4025HS	2	25	25	40	110	17	0.35	2
4025HS-2M25	2	25	25	40	180	17	0.58	1
4025HS-2L25	2	25	25	40	230	17	0.80	1
4026HS	2	26	25	40	110	17	0.37	2
4026HS-2M25	2	26	25	40	180	17	0.60	1
4026HS-2L25	2	26	25	40	230	17	0.82	1
4032HS	3	32	32	40	125	17	0.65	2
4032HS-2M32	2	32	32	50	200	17	1.17	1
4032HS-2L32	2	32	32	50	260	17	1.50	1
4032HS-3M32	3	32	32	50	200	17	1.10	1
4032HS-3L32	3	32	32	50	260	17	1.48	1
4033HS	3	33	32	40	125	17	0.68	2
4033HS-2M32	2	33	32	50	200	17	1.12	1
4033HS-2L32	2	33	32	50	260	17	1.55	1
4033HS-3M32	3	33	32	50	200	17	1.12	1
4033HS-3L32	3	33	32	50	260	17	1.55	1

Available inserts



Designation	Coated										Uncoated	page	Designation	Coated										Uncoated	page										
	Cermet	CN2500	CN30	NC5330	NCM325	NCM335	NCM635	NCM645	PC2505	PC2010				PC3700	PC6510	PC9530	PC9540	PC5300	PC5400	G10	H01	Cermet	CN2500			CN30	NC5330	NCM325	NCM335	NCM635	NCM645	PC2505	PC2510	PC3700	PC6510
APMT 1806PDR-MA																	●	APMT 180624PDR-ML																●	
180604PDR-MA																	●	180630R-ML																●	
180612PDR-MA																	●	1806PDSR-MM									●	●	●	●	●	●	●	●	●
180616PDR-MA																	●	1806PDSR-MF																	●
180620PDR-MA																	●	180612PDSR-MM																	●
180624PDR-MA																	●	180616PDSR-MM																	●
180630R-MA																	●	180620PDSR-MM																	●
1806PDR-ML																	●	180624PDSR-MM																	●
180604PDR-ML																	●	180630R-MM																	●
180612PDR-ML																	●	180632R-MM																	●
180616PDR-ML																	●	1806PDSR-MN3																	●
180620PDR-ML																	●	1806PDSR-MN4																	●

※ Please purchase 2 types of APMT-MN (nick type) inserts with different chip breakers. ※ Please use the cutters with even teeth.

Parts

Specification		
Ø20~Ø21	FTKA0408	TW15S
Ø25~Ø33	FTKA0410	TW15S

Available inserts E06

AMS4000S

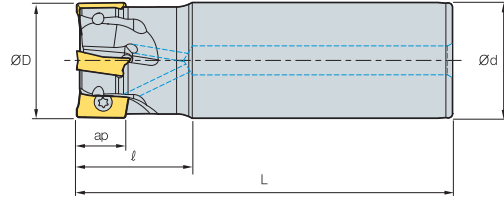


Fig. 1

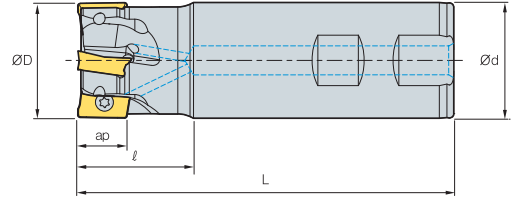


Fig. 2



AA
90°
• AR: 7°~13°
• RR: -20°~6°

(mm)

Designation		ØD	Ød	ℓ	L	ap		Fig.
AMS								
4040HS-3M32	3	40	32	50	200	17	1.20	1
4040HS-3L32	3	40	32	50	260	17	1.60	1
4040HS-4M32	4	40	32	50	200	17	1.20	1
4040HS-4L32	4	40	32	50	260	17	1.60	1
4040HS-S32	4	40	32	40	130	17	0.76	2
4040HS-S40	4	40	40	40	130	17	1.10	2
4040HS-S42	4	40	42	40	130	17	1.20	2
4050HS-S32	5	50	32	40	135	17	0.95	2
4050HS-S40	5	50	40	40	135	17	1.30	2
4050HS-S42	5	50	42	40	135	17	1.40	2
4063HS-S32	6	63	32	40	135	17	1.25	2
4063HS-S40	6	63	40	40	135	17	1.60	2
4063HS-S42	6	63	42	40	135	17	1.70	2

Available inserts

		APMT-MA	APMT-ML	APMT-MM	APMT-MF	APMT-MN															
Designation		Cermet	Coated						Uncoated	page	Designation		Cermet	Coated						Uncoated	page
		CN2500 CN30	NC5330 NCM325 NCM335 NCM635 NCM645	PC2505 PC2010 PC3700 PC6510 PC9530 PC9540 PC5300 PC5400	GT10 H01	E06	CN2500 CN30	NC5330 NCM325 NCM335 NCM645	PC2505 PC2510 PC3700 PC6510 PC9530 PC9540 PC5300 PC5400				GT10 H01	E06							
APMT 1806PDFR-MA										●		APMT 180624PDER-ML									●
180604PDFR-MA									●		180630R-ML								●		
180612PDFR-MA									●		1806PDSR-MM		●		●	●	●	●	●	●	
180616PDFR-MA									●		1806PDSR-MF		●			●		●	●	●	
180620PDFR-MA									●		180612PDSR-MM		●				●		●	●	
180624PDFR-MA									●		180616PDSR-MM		●					●	●	●	
180630R-MA									●		180620PDSR-MM										
1806PDER-ML										●	180624PDSR-MM		●						●	●	
180604PDER-ML									●	●	180630R-MM								●	●	
180612PDER-ML									●		180632R-MM		●						●	●	
180616PDER-ML									●		1806PDSR-MN3									●	
180620PDER-ML									●	●	1806PDSR-MN4									●	

※ Please purchase 2 types of APMT-MN (nick type) inserts with different chip breakers. ※ Please use the cutters with even teeth.

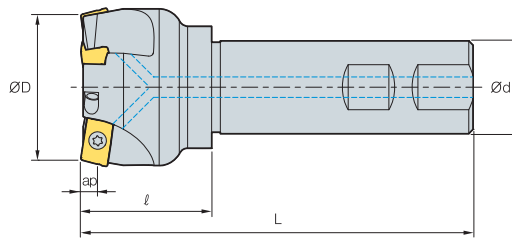
Parts

Specification		
Ø40-Ø63	FTKA0410	TW15S

Available inserts E06



AMS1000SE/2000SE



AA
75°

• AR: -4.5°~1°
• RR: -3°~0°

(mm)

Designation		ØD	Ød	ℓ	L	ap	
AMS 1025HSE	3	25	25	30	115	2.5	0.41
AMS 2025HSE	2	25	25	30	115	4	0.4
2032HSE	3	32	32	40	125	4	0.72
2040HSE	3	40	32	40	130	4	0.86
2040HSE-S40	3	40	40	40	130	4	1.2
2040HSE-S42	3	40	42	40	130	4	1.3
2050HSE	4	50	32	40	135	4	0.98
2050HSE-S40	4	50	40	40	135	4	1.3
2050HSE-S42	4	50	42	40	135	4	1.4
2063HSE	5	63	32	40	135	4	1.24
2063HSE-S40	5	63	40	40	135	4	1.57
2063HSE-S42	5	63	42	40	135	4	1.62

Available inserts

APMT-MF APMT-MM



Type	Designation	Cermet		Coated										Uncoated		page		
		CN2500	CN30	NC5330	NCM325	NCM335	NCM535	NCM545	PC2505	PC2510	PC3700	PC6510	PC9530	PC9540	PC5300		PC5400	G10
1000 type	APMT 060202PDSR-MM			●														
	0602PDSR-MM			●					●	●	●	●		●	●			
	060208PDSR-MM			●						●				●	●			
	060212R-MM			●										●	●			
	060216R-MM													●	●			
2000 type	APMT 11T3PDSR-MM			●	●		●		●	●	●			●	●			
	11T3PDSR-MF			●						●	●			●	●			
	11T308PDSR-MM			●						●		●		●	●			
	11T312PDSR-MM			●						●		●		●	●			
	11T316R-MM			●						●				●	●			
	11T318R-MM													●	●			
	11T324R-MM			●						●				●	●			

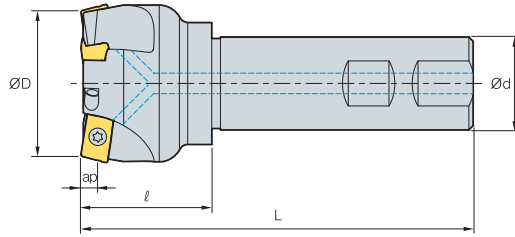
Parts

Specification			
Ø25 (1000 type)	FTKA01842	-	TW06S-A
Ø25~Ø63 (2000 type)	FTKA02565S	TW08S	-

Available inserts **E06**



AMS3000SE



AA
75°

• AR: -4.5°~1°
• RR: -3°~0°

(mm)

Designation		ØD	Ød	l	L	ap	
AMS 3050HSE	3	50	32	45	135	6	1.0
3050HSE-S40	3	50	40	45	135	6	1.3
3050HSE-S42	3	50	42	45	135	6	1.4
3063HSE	4	63	32	45	135	6	1.3
3063HSE-S40	4	63	40	45	135	6	1.6
3063HSE-S42	4	63	42	45	135	6	1.7

Available inserts

APMT-MF APMT-MM



Designation	Cermet		Coated										Uncoated		page			
	CN2500	CN30	NC5330	NCM325	NCM335	NCM535	NCM545	PC2505	PC2510	PC3700	PC6510	PC9530	PC9540	PC5300		PC5400	G10	H01
APMT 1604PDSR-MM			●	●		●		●	●	●	●	●	●	●	●			E06
1604PDSR-MF			●								●			●	●			
160410PDSR-MM										●				●	●			
160416PDSR-MM			●							●				●	●			
160424R-MM			●							●				●	●			
160430R-MM										●				●	●			
160432R-MM			●							●				●	●			

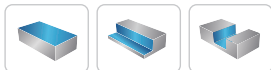
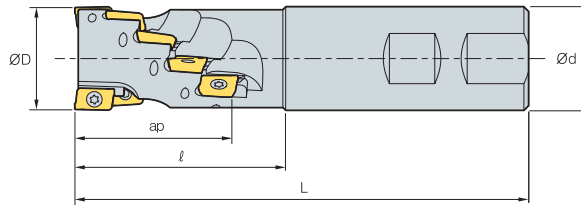
Parts

Specification		
Ø50~Ø63	FTKA0410	TW15S

Available inserts E06



AMS1000M/1500M



AA
90°
• AR: 7°~9°
• RR: -13°~-10°

(mm)

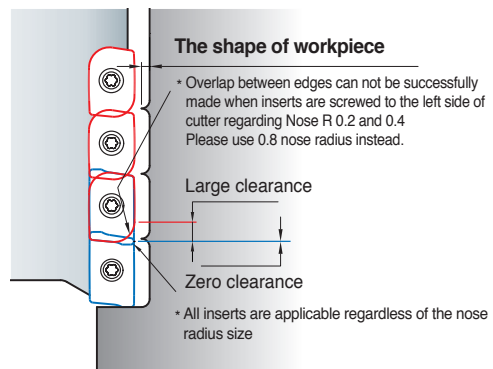
Designation		ØD	Ød	l	L	No. of flute	ap	
AMS 1016M	6	16	16	30	80	2	15.5	0.3
	12	20	20	32	85	3	20.5	0.3
	20	25	25	39	95	4	25.5	0.3
AMS 15020M	3	20	20	42	105	1	26.5	0.3
	8	25	25	50	110	2	35	0.3
	10	32	32	60	120	2	44	0.3

Available inserts



Type	Designation	Cermet		Coated											Uncoated		page		
		CN2500	CN30	NC5330	NCM325	NCM335	NCM635	NCM645	PC2505	PC2510	PC3700	PC6510	PC9530	PC9540	PC5300	PC5400		G10	H01
1000 type	APMT 0602PDFR-MA																	●	E06
	APMT 060208PDFR-MA																		
	APMT 060202PDSR-MM			●						●	●	●	●		●	●			
	APMT 0602PDSR-MM			●					●	●	●	●	●		●	●			
	APMT 060208PDSR-MM			●					●	●	●	●	●		●	●			
	APMT 060212R-MM			●											●	●			
1500 type	APMT 060216R-MM													●	●				
	APMT 0903PDFR-MA																●		
	APMT 090308PDFR-MA																		
	APMT 0903PDER-ML														●	●			
	APMT 090308PDER-ML														●	●			
	APMT 0903PDSR-MM			●					●	●	●	●		●	●				
	APMT 090308PDSR-MM			●					●	●	●	●		●	●				
	APMT 090312R-MM								●	●	●	●		●	●				
APMT 090316R-MM			●										●	●					
APMT 090320R-MM									●	●	●		●	●					

Caution when clamping the inserts

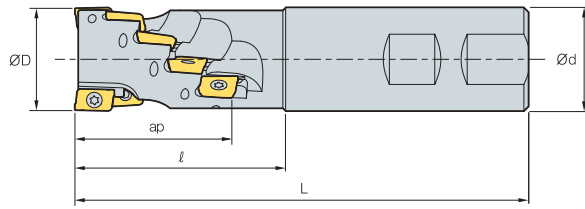


Parts

Specification			
Ø16~Ø25 (1000 type)	FTKA01842	-	TW06S-A
Ø20~Ø32 (1500 type)	FTKA02565S	TW08S	-

Available inserts **E06**

AMS2000M



AA
90°
• AR: 7°~9°
• RR: -13°~-10°

(mm)

Designation		ØD	Ød	ℓ	L	No. of flute	ap		
AMS	2020M	3	20	20	45	120	1	29.4	0.32
	2025M	8	25	25	55	130	2	38.9	0.40
	2032M	10	32	32	65	140	2	48.5	0.65
	2040M	14	40	40	75	150	2	58	0.75

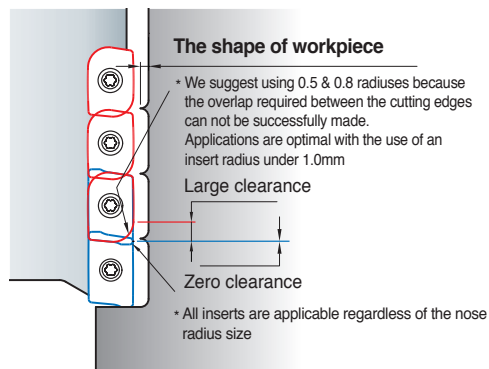
Available inserts



Designation	Cermet		Coated										Uncoated		page			
	CN2500	CN30	NC5330	NCM325	NCM335	NCM335	NCM545	PC2505	PC2510	PC3700	PC6510	PC9530	PC9540	PC5300		PC5400	G10	H01
APMT	11T3PDFR-MA																	●
	11T308PDFR-MA																	
	11T3PDER-ML													●	●			
	11T308PDER-ML													●	●			
	11T3PDSR-MM			●	●		●	●	●	●	●	●		●	●			
	11T3PDSR-MF			●					●	●				●	●			
	11T308PDSR-MM			●					●		●	●		●	●			
	11T312PDSR-MM			●					●		●			●	●			
	11T316R-MM			●					●					●	●			
	11T318R-MM			●										●	●			
	11T324R-MM			●					●					●	●			
	11T3PDSR-MN2													●				
	11T3PDSR-MN3													●				

※ Please purchase 2 types of APMT-MN (nick type) inserts with different chip breakers. ※ Please use the cutters with even teeth.

Caution when clamping the inserts



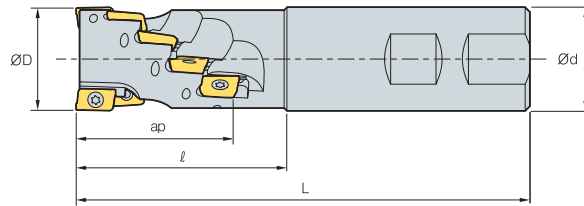
Parts

Specification		
Ø20~Ø40	FTKA02565S	TW08S

Available inserts E06



AMS4000M



AA
90°
• AR: 7°~9°
• RR: -13°~10°

(mm)

Designation		ØD	Ød	l	L	No. of flute	ap	
AMS	4032M	4	32	32	60	130	2	0.65
	4040M	6	40	40	70	140	2	1.11
	4050M-S40	6	50	40	55	125	2	1.22
	4050M	8	50	40	70	140	2	1.37

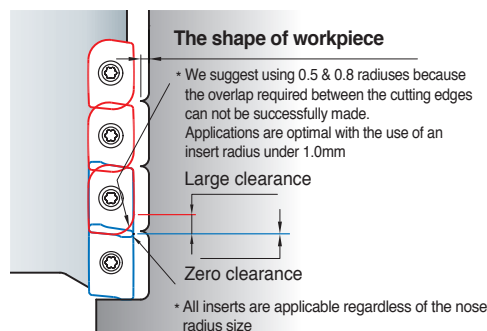
Available inserts



Designation	Cermet		Coated											Uncoated		page																			
	CN2500	CN30	NC5330	NCM325	NCM335	NCM535	NCM545	PC2505	PC2510	PC3700	PC6510	PC9530	PC9540	PC5300	PC5400		G10	H01																	
APMT	<div style="display: flex; justify-content: space-between; align-items: center;"> 1806PDFR-MA 180604PDFR-MA 180612PDFR-MA 180616PDFR-MA 180620PDFR-MA 180624PDFR-MA 180630R-MA 1806PDER-ML 180604PDER-ML 180612PDER-ML 180616PDER-ML 180620PDER-ML 180624PDER-ML 180630R-ML 1806PDSR-MM 1806PDSR-MF 180612PDSR-MM 180616PDSR-MM 180620PDSR-MM 180624PDSR-MM 180630R-MM 180632R-MM 1806PDSR-MN3 1806PDSR-MN4 </div>																		●	●	●	●	●	●	●	●	●	●	●	●	●	●	●	●	●
																			●	●	●	●	●	●	●	●	●	●	●	●	●	●	●	●	●
																			●	●	●	●	●	●	●	●	●	●	●	●	●	●	●	●	●
																			●	●	●	●	●	●	●	●	●	●	●	●	●	●	●	●	●
																			●	●	●	●	●	●	●	●	●	●	●	●	●	●	●	●	●
																			●	●	●	●	●	●	●	●	●	●	●	●	●	●	●	●	●
																			●	●	●	●	●	●	●	●	●	●	●	●	●	●	●	●	●
																			●	●	●	●	●	●	●	●	●	●	●	●	●	●	●	●	●
																			●	●	●	●	●	●	●	●	●	●	●	●	●	●	●	●	●
																			●	●	●	●	●	●	●	●	●	●	●	●	●	●	●	●	●
																			●	●	●	●	●	●	●	●	●	●	●	●	●	●	●	●	●
																			●	●	●	●	●	●	●	●	●	●	●	●	●	●	●	●	●
																			●	●	●	●	●	●	●	●	●	●	●	●	●	●	●	●	●
																			●	●	●	●	●	●	●	●	●	●	●	●	●	●	●	●	●
																			●	●	●	●	●	●	●	●	●	●	●	●	●	●	●	●	●
																			●	●	●	●	●	●	●	●	●	●	●	●	●	●	●	●	●
																			●	●	●	●	●	●	●	●	●	●	●	●	●	●	●	●	●
																			●	●	●	●	●	●	●	●	●	●	●	●	●	●	●	●	●
																			●	●	●	●	●	●	●	●	●	●	●	●	●	●	●	●	●

※ Please purchase 2 types of APMT-MN (nick type) inserts with different chip breakers.
 ※ Please use the cutters with even teeth.

Caution when clamping the inserts

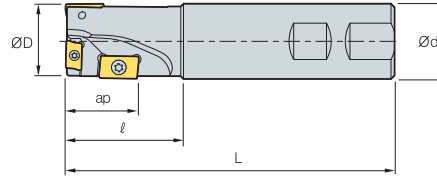


Parts

Specification		
Ø32~Ø50	FTKA0410	TW15S

Available inserts E06

AMS1000MH/1500MH



• AR: 9°~12°
• RR: -12°~10°

(mm)

Designation		ØD	Ød	l	L	ap		APMT 0602	APMT 0903	APM(X)T 11T3 -	APMT 1604	APKT 1604 -
AMS 1014MH	3	14	12	30	120	11	0.16	3	-	-	-	-
	3	16	14	30	140	11	0.20	3	-	-	-	-
	3	18	16	30	140	11	0.21	3	-	-	-	-
AMS 15020MH	3	20	20	35	140	17	0.31	1	2	-	-	-

Available inserts

APMT-MA APMT-ML APMT-MM



Type	Designation	Cermet		Coated										Uncoated		page		
		CN2500	CN30	NC5330	NCM325	NCM335	NCM535	NCM545	PC2505	PC2510	PC3700	PC6510	PC9530	PC9540	PC5300		PC5400	G10
1000 type	APMT 0602PDFR-MA																	●
	060208PDFR-MA																	
	060202PDSR-MM			●						●					●	●		
	0602PDSR-MM			●					●	●	●	●	●		●	●		
	060208PDSR-MM			●							●				●	●		
1500 type	APMT 0903PDFR-MA																	●
	090308PDFR-MA																	
	0903PDER-ML													●	●			
	090308PDER-ML													●	●			
	0903PDSR-MM			●					●	●	●	●		●	●			
090308PDSR-MM			●							●			●	●				

Recommended cutting condition



	Drilling	Shouldering	Slotting
vc(m/min)	80~200	80~200	80~200
fz(mm/t)	0.03~0.06	0.05~0.25	0.05~0.20

• Please keep the drill depth under 0.25D when you're drilling
• Please keep the step depth from 0.2 to 0.3mm

Parts

Specification			
Ø14~Ø18 (1000 type)	FTKA01842	-	TW06S-A
Ø20 (1500 type)	FTKA02565S	TW08S	-

Available inserts E06



AMS2000MH/3000MH(-K)

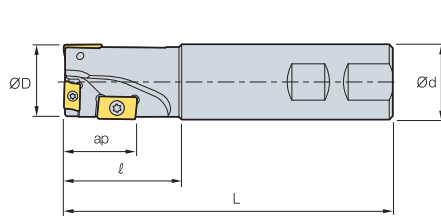


Fig. 1

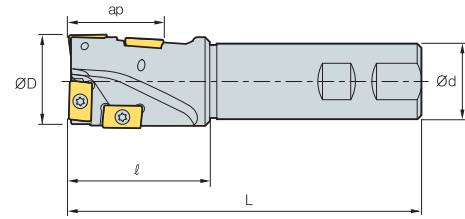


Fig. 2



• AR: 9°~12°
• RR: -12°~-10°

(mm)

Designation		ØD	Ød	ℓ	L	ap		APMT 0602	APMT 0903	APM(X)T 11T3 -	APMT 1604	APKT 1604 -	Fig.
AMS 2025MH	3	25	25	40	130	20	0.45	-	-	3	-	-	1
2032MH	3	32	32	50	140	30	0.75	-	-	1	2	-	1
AMS 3040MH	4	40	32	60	150	40	0.90	-	-	-	4	-	2
3040MH-K	4	40	32	60	150	40	0.90	-	-	-	-	4	2

Available inserts



Type	Designation	Cermet		Coated										Uncoated	page			
		CN2500	CN30	NC5330	NCM325	NCM335	NCM535	NCM545	PC2505	PC2510	PC3700	PC6510	PC9530			PC9540	PC5300	PC5400
2000 type	APMT 11T3PDFR-MA																●	E06
	11T308PDFR-MA																	
	11T3PDER-ML													●	●			
	11T308PDER-ML													●	●			
	11T3PDSR-MM			●	●		●		●	●	●	●	●	●	●	●		
	11T3PDSR-MF			●						●	●			●	●			
	11T308PDSR-MM			●						●		●	●	●	●	●		
	11T312PDSR-MM			●						●		●	●	●	●	●		
	11T316R-MM			●						●				●	●			
	11T318R-MM			●										●	●			
11T324R-MM			●							●			●	●				
3000 type	APMT 1604PDSR-MM			●	●				●	●	●	●	●	●	●			
	1604PDSR-MF			●						●	●		●	●				
3000-K type	APKT 1604PDSR-MM				●	●				●	●	●	●					
	1604PDSR-MF				●								●					

Parts

Specification			
	Screw	Wrench	Wrench
Ø25 (2000 type)	FTKA02565S	TW08S	-
Ø32 (2000 type)	FTKA02565S+FTKA0410	TW08S+TW15S	-
Ø40 (3000 type)	FTKA0410	TW15S	-

Available inserts E06

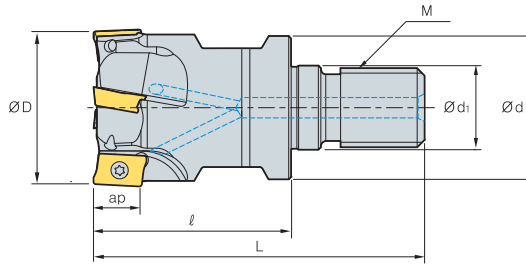
Recommended cutting condition

	Drilling	Shouldering	Slotting
vc(m/min)	80~200	80~200	80~200
fz(mm/t)	0.03~0.06	0.05~0.25	0.05~0.20

• Please keep the drill depth under 0.25D when you're drilling
• Please keep the step depth from 0.2 to 0.3mm



AMM1000



AA
90°
• AR: 7.5°~12.5°
• RR: -28°~6°

(mm)

Designation		ØD	Ød	Ød1	l	L	M	ap	
AMM 1012HR-M06	3	12	11	6.5	25	40	M06	5.6	0.02
1016HR-M08	4	16	14.5	8.5	25	42	M08	5.6	0.03
1020HR-M10	5	20	18	10.5	30	51	M10	5.6	0.07
1025HR-M12	7	25	23	12.5	35	59	M12	5.6	0.12
1032HR-M16	8	32	29	17	40	67	M16	5.6	0.23

Available inserts

APMT-MA APMT-MM



Designation	Cermet		Coated											Uncoated		page		
	CN2500	CN30	NC5330	NCM325	NCM335	NCM535	NCM545	PC2505	PC2510	PC3700	PC6510	PC9530	PC9540	PC5300	PC5400		G10	H01
APMT 0602PDFR-MA																		●
060208PDFR-MA																		
060202PDSR-MM			●							●				●	●			
0602PDSR-MM			●					●	●	●	●	●		●	●			
060208PDSR-MM			●							●				●	●			
060212R-MM			●											●	●			
060216R-MM														●	●			

Available adaptor

Designation	Available adaptor
AMM 1012HR-M06	MAT-M06
1016HR-M08	MAT-M08
1020HR-M10	MAT-M10
1025HR-M12	MAT-M12
1032HR-M16	MAT-M16

Designation : AMM1032HR-M16
Modular head threading measure size (M16)

II

Adaptor spec.: MAT-M16-035-S32S
Adaptor threading measure (M16)

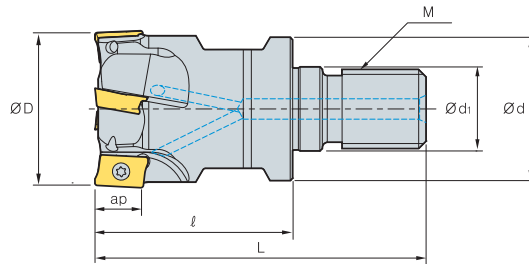
Parts

Specification		
Ø12~Ø32	FTKA01842	TW06S-A

Available inserts E06 Available adaptor E401~E402



AMM1500



AA
90°
• AR: 7.5°~12.5°
• RR: -28°~-6°

(mm)

Designation	ØD	Ød	Ød1	ℓ	L	M	ap	kg
AMM 15010HR-M06	10	9.5	6.5	25	40	M06	9	0.01
15012HR-M06	12	11	6.5	25	40	M06	9	0.02
15016HR-M08	16	14.5	8.5	25	42	M08	9	0.03
15020HR-M10	20	18	10.5	30	51	M10	9	0.06
15025HR-M12	25	23	12.5	35	59	M12	9	0.12
15032HR-M16	32	29	17	40	67	M16	9	0.22

Available inserts

APMT-MA APMT-ML APMT-MM



Designation	Cermet		Coated											Uncoated		page			
	CN2500	CN80	NC5330	NCM825	NCM835	NCM835	NCM635	NCM645	PC2505	PC2510	PC3700	PC6510	PC9530	PC9540	PC6300		PC5400	G10	H01
APMT 0903PDFR-MA																		●	E06
090308PDFR-MA																			
0903PDER-ML															●	●			
090308PDER-ML															●	●			
0903PDSR-MM			●					●	●	●	●				●	●			
090308PDSR-MM			●												●	●			
090312R-MM															●	●			
090316R-MM			●												●	●			
090320R-MM															●	●			

Available adaptor

Designation	Available adaptor
AMM 15010HR-M06	MAT-M06
15012HR-M06	
15016HR-M08	MAT-M08
15020HR-M10	MAT-M10
15025HR-M12	MAT-M12
15032HR-M16	MAT-M16

Designation : AMM15032HR-M16
Modular head threading measure size (M16)

II

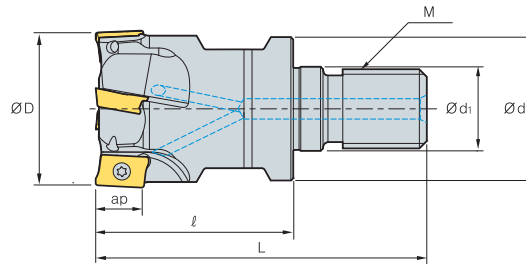
Adaptor spec.: MAT-M16-035-S32S
Adaptor threading measure (M16)

Parts

Specification	Screw	Wrench
Ø10~Ø14 Ø16~Ø100	FTKA02555S FTKA02565S	TW08S

Available inserts E06 Available adaptor E401~E402

AMM2000



• AR: 7.5°~12.5°
• RR: -28°~6°

(mm)

Designation		ØD	Ød	Ød1	l	L	M	ap	
AMM 2016HR-M08	2	16	14.5	8.5	25	42	M08	11	0.04
2020HR-M10	2	20	18	10.5	30	51	M10	11	0.07
2025HR-M12	3	25	23	12.5	35	59	M12	11	0.04
2032HR-M16	4	32	29	17	40	67	M16	11	0.23
2040HR-M16	5	40	29	17	40	67	M16	11	0.25

Available inserts



Designation	Cermet		Coated												Uncoated		page	
	CN2500	CN30	NC5330	NCM325	NCM335	NCM535	NCM545	PC2505	PC2510	PC3700	PC6510	PC9530	PC9540	PC5300	PC5400	G10		H01
APMT 11T3PDFR-MA																		●
11T308PDFR-MA																		
11T3PDER-ML															●	●		
11T308PDER-ML															●	●		
11T3PDSR-MM			●	●		●		●	●	●	●	●	●	●	●	●		
11T3PDSR-MF			●							●	●				●	●		
11T308PDSR-MM			●							●	●		●		●	●		
11T312PDSR-MM			●							●		●			●	●		
11T316R-MM			●							●					●	●		
11T318R-MM																		
11T324R-MM			●							●					●	●		
11T3PDSR-MN2															●			
11T3PDSR-MN3															●			

* Please purchase 2 types of APMT-MN (nick type) inserts with different chip breakers. * Please use the cutters with even teeth.

Available adaptor

Designation	Available adaptor
AMM 2016HR-M08	MAT-M08
2020HR-M10	MAT-M10
2025HR-M12	MAT-M12
2032HR-M16	MAT-M16
2040HR-M16	

Designation : AMM2032HR-M16
Modular head threading measure size (M16)

||

Adaptor spec.: MAT-M16-035-S32S
Adaptor threading measure (M16)

Parts

Specification		
Ø16~Ø40	FTKA02565S	TW08S

Available inserts E06 Available adaptor E401~E402



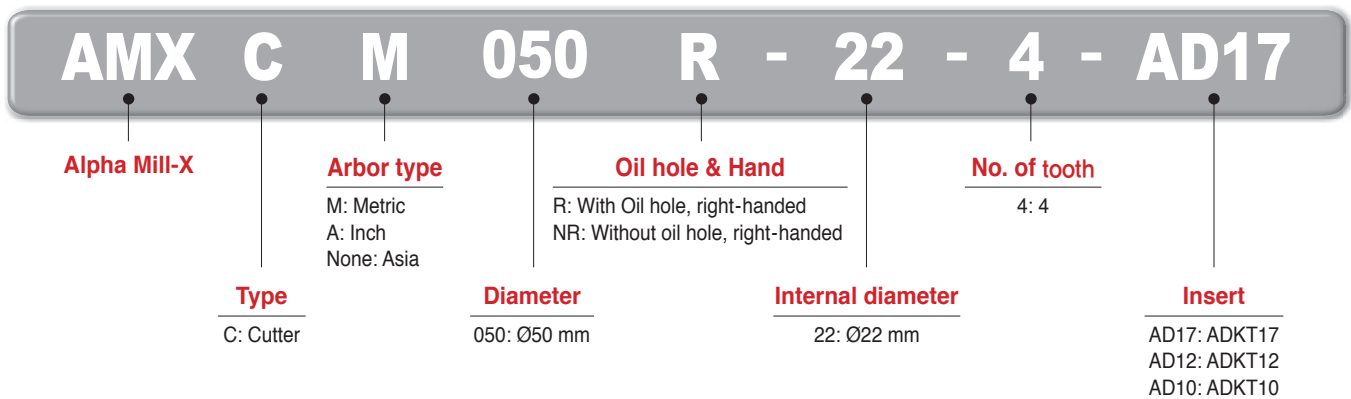
Shoulder milling tool for high helix

Alpha Mill-X **new**

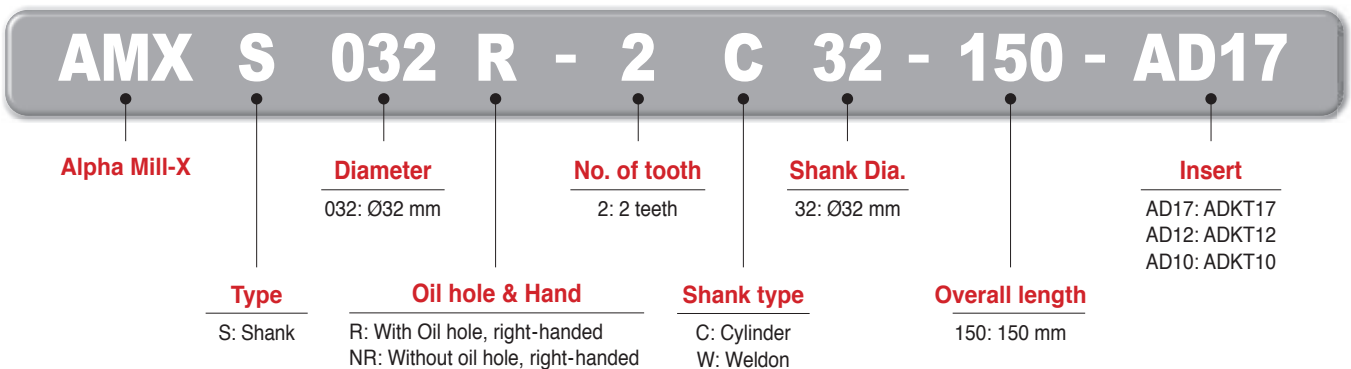
- High helix cutting edge realizes high speed and high feed machining (15% higher speed than conventional tool's machining) and increases 20% higher productivity.
- Highly precise cutting edge ensures high quality surface finish in milling.

Code system

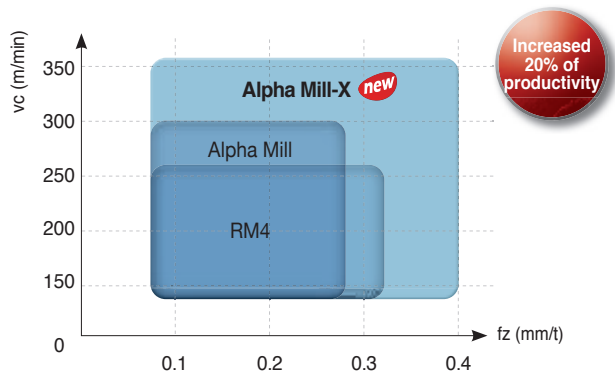
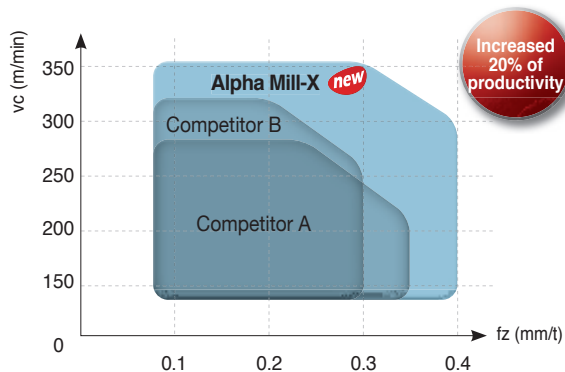
• Cutter



• Shank



Application area



E Technical Information for Alpha Mill-X

Features of insert

High rake angle chip breaker

- Applied high rake angle
- Improved chip control

Proprietary relief surface shape

- High rigidity of insert

Max. ap

ADKT17: 16.5 mm

ADKT12: 11.5 mm

ADKT10: 9.5 mm

Applied minor cutting edge with a wiper function

- Minor cutting edge design optimized for excellent surface finish

Flat clamping area

- Stable clamping in high speed and high feed machining

High rake cutting edge

- Better surface toughness
- Lower cutting load

Increased thickness

Existing Alpha Mill
(APMT1604PDSR-MM)

High rake cutting edge

Alpha Mill-X
(ADKT170608PESR-MM)

- Applying cutting edge with high rake angle: decreased cutting load
- Thicker insert: high rigidity of insert

▶ **Optimal for high speed and high feed machining**

Cutter features

High rake angle cutting edge

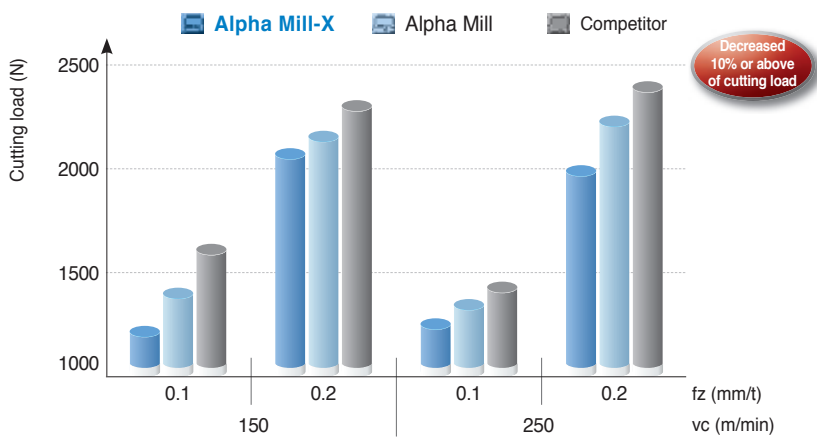
- Improved surface finish
- Decreased cutting load

Wider chip pocket

- Maximized chip control
- Outstanding chip control in high speed and high feed machining

Perfect perpendicularity

Cutting load



Recommended cutting conditions

• In face machining and shouldering

Workpiece		Grade	Cutting speed vc (m/min)	Feed, fz (mm/t)		
				ADKT17	ADKT12	ADKT10
P	Steel	PC5300	150-240	0.3-0.05	0.25-0.05	0.2-0.05
		PC5400	130-210			
		PC3700	160-270			
		NCM535	250-350			
M	Stainless steel	PC5300	90-150	0.25-0.05	0.2-0.05	0.15-0.05
		PC5400	70-120			
		PC9540	50-120			
K	Cast iron	PC6510	150-200	0.35-0.08	0.3-0.08	0.25-0.08
		PC5300	120-200			
		NCM535	200-300			
S	HRSA	PC5300	40-70	0.2-0.05	0.15-0.05	0.1-0.05
		PC5400	30-50			

* The above data refer to general cutting conditions and can be adjustable up to 350 m/min and 0.4 mm/t depending on user environment

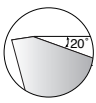
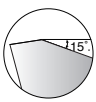
• In grooving, ramping and helical machining

Workpiece		Grade	Cutting speed vc (m/min)	Feed, fz (mm/t)		
				ADKT17	ADKT12	ADKT10
P	Steel	PC5300	150-240	0.15-0.05	0.15-0.05	0.15-0.05
		PC5400	130-210			
		PC3700	160-270			
		NCM535	250-350			
M	Stainless steel	PC5300	90-150	0.15-0.05	0.15-0.05	0.15-0.05
		PC5400	70-120			
		PC9540	50-120			
K	Cast iron	PC6510	150-250	0.2-0.08	0.2-0.08	0.2-0.08
		PC5300	120-200			
		NCM535	200-300			
S	HRSA	PC5300	40-70	0.15-0.05	0.15-0.05	0.1-0.05
		PC5400	30-50			

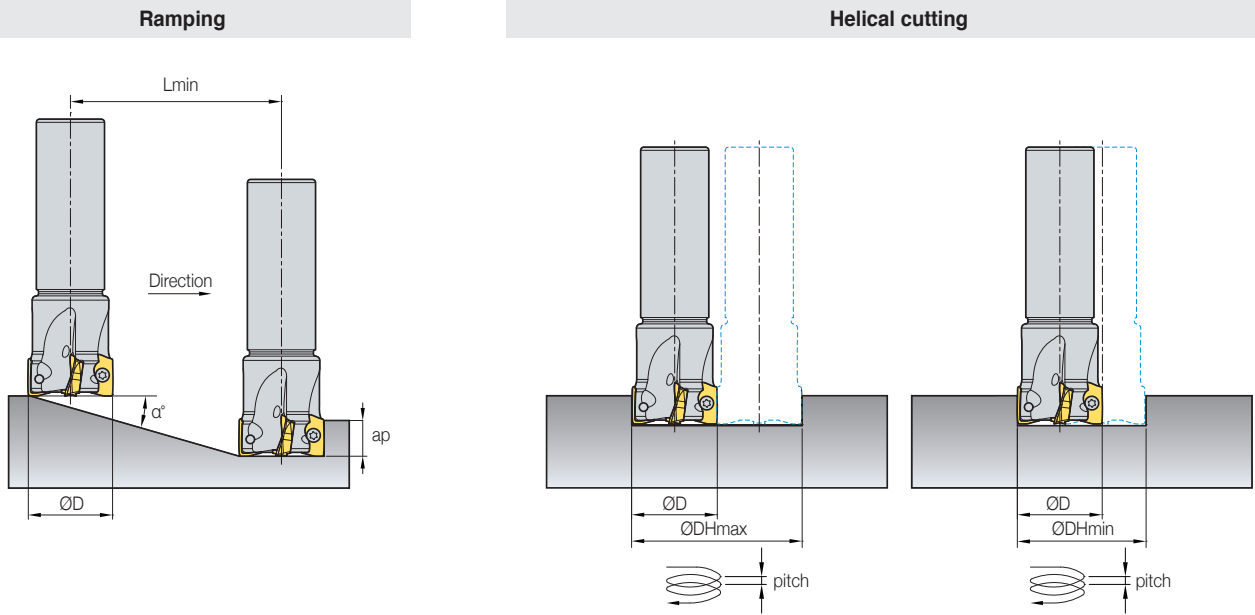
* In deep grooving, set the ap under 5 mm and use coolant and air.

Recommended grades and chip breakers

(● : 1st Recommendation)

C/B	Cutting edge	P		M		K		N		S			
		Low carbon steel/ Mild steel		High carbon steel/ Alloy steel		Stainless steel		Cast iron		Non-ferrous metal			
		C/B	Grade	C/B	Grade	C/B	Grade	C/B	Grade	C/B	Grade		
ML		-	● PC3700 ○ PC5300 ○ PC5400 ○ NCM535	-	● PC3700 ○ PC5300 ○ PC5400 ○ NCM535	●	● PC5300 ○ PC5400 ○ PC9540	-	● PC6510 ○ PC5300 ○ PC5400 ○ NCM535	-	-	●	● PC5300 ○ PC5400
MM		●	● PC3700 ○ PC5300 ○ PC5400 ○ NCM535	●	● PC3700 ○ PC5300 ○ PC5400 ○ NCM535	-	● PC5300 ○ PC5400 ○ PC9540	●	● PC6510 ○ PC5300 ○ PC5400 ○ NCM535	-	-	-	● PC5300 ○ PC5400

➤ Cutting condition for ramping and helical operation



(mm)

Designation	Tool dia. ØD (min)	ap	Ramping		Blind hole helical cutting				Through hole helical cutting	
			Max. rake angle α°	Lmin	Min. desirable hole dia. ØDHmin	Max. pitch dmax	Max. desirable hole dia. ØDHmax	Max. pitch dmax	Min. desirable hole dia. ØDHmin	Max. pitch dmax
ADKT17	20	16.5	13	71	30	7.0	38	8.9	21	4.8
	25		8.0	117	40	5.7	48	6.8	31	4.3
	32		3.7	255	54	3.5	62	4.0	45	2.9
	33		3.6	262	56	3.5	64	4.1	47	2.9
	40		2.6	363	70	3.2	78	3.6	61	2.8
	50		1.9	497	90	3.0	98	3.3	81	2.7
	63		1.3	727	116	2.6	124	2.8	107	2.4
	80		1.1	859	150	2.9	158	3.0	141	2.7
	100		0.7	1350	190	2.3	198	2.4	181	2.2
	125	0.5	1891	240	2.1	248	2.2	231	2.0	
ADKT12	18	11.5	7.0	98	29	3.6	34	4.2	23	2.8
	20		5.5	125	33	3.2	38	3.7	27	2.6
	25		3.5	196	43	2.7	48	3.0	37	2.3
	32		2.5	275	57	2.5	62	2.7	51	2.2
	33		2.4	286	59	2.5	64	2.7	53	2.2
	40		1.5	458	73	1.9	78	2.1	67	1.7
	50		1.2	573	93	2.0	98	2.1	87	1.8
	63		1.0	687	119	2.1	124	2.2	113	2.0
	80	0.7	982	153	1.9	158	1.9	147	1.8	
ADKT10	16	9.5	4.5	121	28	2.2	31	2.5	24	1.9
	18		3.5	155	32	2.0	35	2.2	28	1.7
	20		3.0	181	36	1.9	39	2.1	32	1.7
	25		2.2	247	46	1.8	49	1.9	42	1.6
	32		1.5	363	60	1.6	63	1.7	56	1.5
	33		1.4	389	62	1.5	65	1.6	58	1.4
	40		1.2	454	76	1.6	79	1.7	72	1.5
	50		0.8	680	96	1.3	99	1.4	92	1.3
	63		0.6	907	122	1.3	125	1.3	118	1.2
	80	0.5	1089	156	1.4	159	1.4	152	1.3	

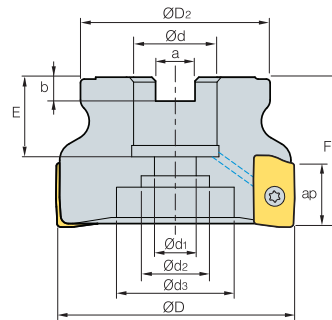
※ In ramping and helical machining, use coolant and air.

※ Lmin : Cutting length in machining with Min. rake angle
 α° : Rake angle for ramping
 ap : Depth of cut in axial direction

$$Lmin = \frac{ap}{\tan \alpha^\circ} \text{ (mm)}$$



AMXCM-AD10/12 **new**



AA
90°
• AR: 8°
• RR: -10°~3°

(mm)

Designation	⊙	ØD	ØD2	Ød	Ød1	Ød2	Ød3	a	b	E	F	ap	kg	
AMXCM	040R-16-5-AD10	5	40	35	16	9	14	-	8.4	5.6	19	40	9.5	0.18
	040R-16-6-AD10	6	40	35	16	9	14	-	8.4	5.6	19	40	9.5	0.18
	050R-22-6-AD10	6	50	42	22	11	18	-	10.4	6.3	20	40	9.5	0.23
	050R-22-7-AD10	7	50	42	22	11	18	-	10.4	6.3	20	40	9.5	0.20
	063R-22-7-AD10	7	63	49	22	11	18	-	10.4	6.3	20	40	9.5	0.44
	063R-22-8-AD10	8	63	49	22	11	18	-	10.4	6.3	20	40	9.5	0.49
	080R-27-8-AD10	8	80	57	27	14	25	38	12.4	7	23	50	9.5	0.88
	080R-27-9-AD10	9	80	57	27	14	25	38	12.4	7	23	50	9.5	0.90
AMXCM	040R-16-4-AD12	4	40	35	16	9	14	-	8.4	5.6	19	40	11.5	0.18
	040R-16-5-AD12	5	40	35	16	9	14	-	8.4	5.6	19	40	11.5	0.16
	050R-22-5-AD12	5	50	42	22	11	18	-	10.4	6.3	20	40	11.5	0.23
	050R-22-7-AD12	7	50	42	22	11	18	-	10.4	6.3	20	40	11.5	0.20
	063R-22-6-AD12	6	63	49	22	11	18	-	10.4	6.3	20	40	11.5	0.44
	063R-22-7-AD12	7	63	49	22	11	18	-	10.4	6.3	20	40	11.5	0.49
	080R-27-7-AD12	7	80	57	27	14	25	38	12.4	7	23	50	11.5	0.88
	080R-27-8-AD12	8	80	57	27	14	25	38	12.4	7	23	50	11.5	0.90

Available inserts

ADKT-ML ADKT-MM



Type	Designation	Cermet		Coated										Uncoated		page		
		CN2500	CN30	NC5330	NCM325	NCM335	NCM535	NCM545	PC2505	PC2010	PC3700	PC6510	PC9530	PC9540	PC5300		PC5400	G10
10 type	ADKT 10T304PEER-ML						●			●	●		●	●	●			E04
	10T304PESR-MM						●			●	●		●	●	●			
	10T308PESR-MM													●	●			
	10T312PESR-MM														●			
12 type	ADKT 120408PESR-ML						●			●	●		●	●	●			
	120408PESR-MM						●			●	●		●	●	●			
	120412PESR-MM									●	●		●	●	●			
	120416PESR-MM									●	●		●	●	●			

Available arbors

Designation	Ød	Available arbors
AMXCM 040R-16-□-AD□□	16	BT□□-FMC16-□□
AMXCM 050R-22-□-AD□□	22	BT□□-FMC22-□□

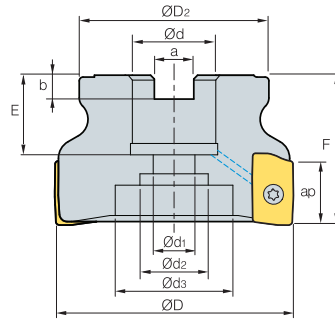
Designation	Ød	Available arbors
AMXCM 063R-22-□-AD□□	22	BT□□-FMC22-□□
AMXCM 080R-27-□-AD□□	27	BT□□-FMC27-□□

Parts

Specification	Screw	Wrench
Ø40~Ø80 (10 type)	FTKA02555S	TW08S
Ø40~Ø80 (12 type)	FTNA0306	TW09S

Available inserts E04 Available arbors and bolt E426~E428

AMXCM-AD17 new



• AR: 8°
• RR: -10°~3°

(mm)

Designation	齿数	ØD	ØD2	Ød	Ød1	Ød2	Ød3	a	b	E	F	ap	kg	
AMXCM	040R-16-3-AD17	3	40	35	16	9	14	-	8.4	5.6	19	40	16.5	0.18
	040R-16-4-AD17	4	40	35	16	9	14	-	8.4	5.6	19	40	16.5	0.18
	050R-22-4-AD17	4	50	42	22	11	18	-	10.4	6.3	20	40	16.5	0.23
	050R-22-5-AD17	5	50	42	22	11	18	-	10.4	6.3	20	40	16.5	0.20
	063R-22-5-AD17	5	63	49	22	11	18	-	10.4	6.3	20	40	16.5	0.44
	063R-22-6-AD17	6	63	49	22	11	18	-	10.4	6.3	20	40	16.5	0.49
	080R-27-6-AD17	6	80	57	27	14	25	38	12.4	7	23	50	16.5	0.88
	080R-27-7-AD17	7	80	57	27	14	25	38	12.4	7	23	50	16.5	0.90
	100R-32-8-AD17	8	100	70	32	18	28	45	14.4	8	28	63	16.5	1.76
	100R-32-10-AD17	10	100	70	32	18	28	45	14.4	8	28	63	16.5	1.68
	125R-40-8-AD17	8	125	90	40	22	32	54	16.4	9	30	63	16.5	2.89
	125R-40-10-AD17	10	125	90	40	22	32	54	16.4	9	30	63	16.5	4.83

Available inserts

ADKT-ML ADKT-MM



Designation	Cermet		Coated												Uncoated		page	
	CN2500	CN30	NC5330	NCM325	NCM335	NCM535	NCM545	PC2505	PC2010	PC3700	PC6510	PC9530	PC9540	PC5300	PC5400	G10		H01
ADKT 170608PESR-ML						●				●	●		●	●	●			E04
170604PESR-MM										●				●				
170608PESR-MM						●				●	●		●	●	●			
170616PESR-MM														●	●			
170620PESR-MM														●	●			

Available arbors

Designation	Ød	Available arbors	Designation	Ød	Available arbors
AMXCM 040R-16-□-AD□□	16	BT□□-FMC16-□□	AMXCM 080R-27-□-AD□□	27	BT□□-FMC27-□□
050R-22-□-AD□□	22	BT□□-FMC22-□□	100R-32-□-AD□□	32	BT□□-FMC32-□□
063R-22-□-AD□□			125R-40-□-AD□□	40	BT□□-FMC40-□□

Parts

Specification		
Ø40~Ø125	FTKA0408	TW15S

Available inserts E04 Available arbors and bolt E426-E428



AMXS-AD10/12 new

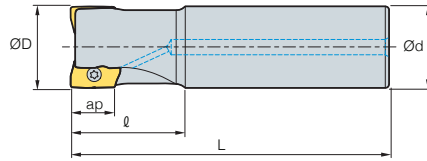


Fig. 1

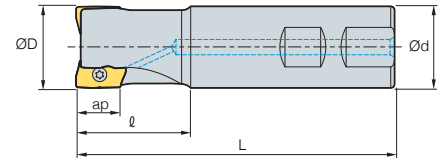


Fig. 2



• AR: 8°
• RR: -10°~3°

(mm)

Designation		ØD	Ød	ℓ	L	ap		Fig.
AMXS	016R-2W16-90-AD10	2	16	16	25	90	0.110	2
	016R-2C16-180-AD10	2	16	16	25	180	0.190	1
	018R-2W16-100-AD10	2	18	16	35	100	0.120	2
	018R-2C16-200-AD10	2	18	16	35	200	0.210	1
	020R-3W20-100-AD10	3	20	20	35	100	0.250	2
	020R-3C20-200-AD10	3	20	20	35	200	0.490	1
	025R-4W25-115-AD10	4	25	25	40	115	0.400	2
	025R-4C25-200-AD10	4	25	25	40	200	0.590	1
	032R-4W32-125-AD10	4	32	32	45	125	0.700	2
	032R-4C32-200-AD10	4	32	32	45	200	1.000	1
	040R-5W32-130-AD10	5	40	32	50	130	1.050	2
	040R-5C32-200-AD10	5	40	32	50	200	1.200	1
AMXS	018R-2W16-100-AD12	2	18	16	35	100	0.120	2
	018R-2C16-200-AD12	2	18	16	35	200	0.210	1
	020R-2W20-100-AD12	2	20	20	35	100	0.250	2
	020R-2C20-200-AD12	2	20	20	35	200	0.490	1
	025R-3W25-115-AD12	3	25	25	40	115	0.400	2
	025R-3C25-200-AD12	3	25	25	40	200	0.590	1
	032R-4W32-125-AD12	4	32	32	45	125	0.700	2
	032R-4C32-200-AD12	4	32	32	45	200	1.000	1
	040R-4W32-130-AD12	4	40	32	50	130	1.050	2
	040R-4C32-200-AD12	4	40	32	50	200	1.200	1

Available inserts

ADKT-ML ADKT-MM



Type	Designation	Cermet		Coated										Uncoated		page		
		CN2500	CN30	NC5330	NCM325	NCM335	NCM535	NCM545	PC2505	PC2010	PC3700	PC6510	PC9530	PC9540	PC5300		PC5400	G10
10 type	ADKT	10T304PEER-ML					●				●	●		●	●			E04
		10T304PESR-MM					●			●	●		●	●				
		10T308PESR-MM													●	●		
		10T312PESR-MM														●		
12 type	ADKT	120408PESR-ML					●				●	●		●	●			E04
		120408PESR-MM					●			●	●		●	●				
		120412PESR-MM								●	●			●	●			
		120416PESR-MM								●	●			●	●			

Parts

Specification		
Ø16~Ø40 (10 type)	FTKA02555S	TW08S
Ø18~Ø40 (12 type)	FTNA0306	TW09S

Available inserts E04 Available arbors and bolt E426~E428



AMXS-AD17 new

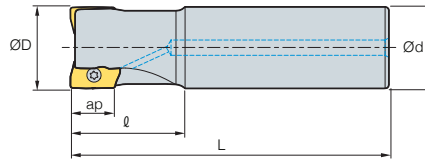


Fig. 1

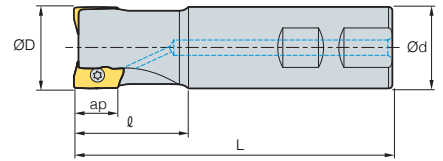


Fig. 2



AA
90°
• AR: 8°
• RR: -10°~3°

(mm)

Designation		ØD	Ød	ℓ	L	ap		Fig.
AMXS 020R-1W20-100-AD17	1	20	20	35	100	16.5	0.170	2
020R-1C20-200-AD17	1	20	20	35	200	16.5	0.360	1
025R-2W25-115-AD17	2	25	25	35	115	16.5	0.610	2
025R-2C25-200-AD17	2	25	25	35	200	16.5	0.450	1
032R-3W32-125-AD17	3	32	32	45	125	16.5	0.620	2
032R-3C32-200-AD17	3	32	32	45	200	16.5	1.050	1
033R-3W32-125-AD17	3	33	32	45	125	16.5	0.620	2
033R-3C32-200-AD17	3	33	32	45	200	16.5	1.050	1
040R-3W32-130-AD17	3	40	32	50	130	16.5	0.750	2
040R-3C32-200-AD17	3	40	32	50	200	16.5	1.170	1
040R-4W32-130-AD17	4	40	32	50	130	16.5	0.740	2
040R-4C32-200-AD17	4	40	32	50	200	16.5	1.200	1

Available inserts

ADKT-ML ADKT-MM



Designation	Cermet		Coated											Uncoated		page		
	CN2500	CN30	NC5330	NCM325	NCM335	NCM535	NCM545	PC2505	PC2010	PC3700	PC6510	PC9530	PC9540	PC5300	PC5400		G10	H01
ADKT 170608PESR-ML						●				●	●		●	●	●			E04
170604PESR-MM										●				●				
170608PESR-MM						●				●	●		●	●	●			
170616PESR-MM														●	●			
170620PESR-MM														●	●			

Parts

Specification		
Ø20-Ø40	FTKA0408	TW15S

Available inserts E04 Available arbors and bolt E426-E428



Rigid body employs high tensile aluminum

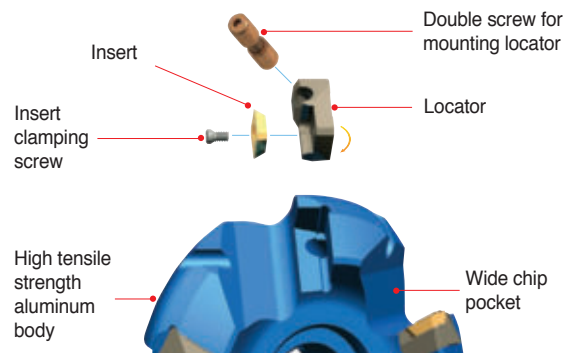
Future Mill

- Light-weight aluminum body (50% of steel body) can be used for high speed cutting, tapping center, and on low power machines
- Easy handling
- It can be used for aluminum alloys, medium cutting of steel, and cast iron
- Rigid body employs high tensile aluminum
- Locators for excellent durability
- A variety of chip breaker are available
- The high rake angle provides low cutting loads and good surface roughness

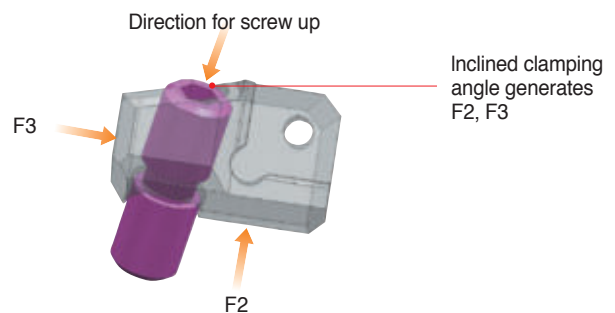
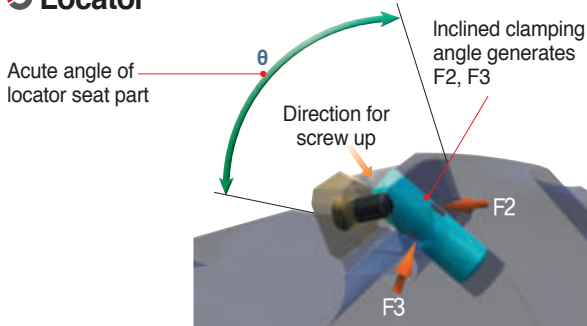
Features of cutter

- Strong clamping between aluminum body and locator with double screw provides high efficiency
- Acute angle of locator seat provides strong clamping
- Wide chip pocket area provides good chip evacuation
- High tensile strength aluminum body

Assembly structure of cutter

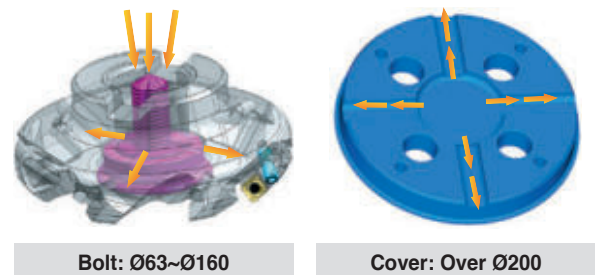


Locator

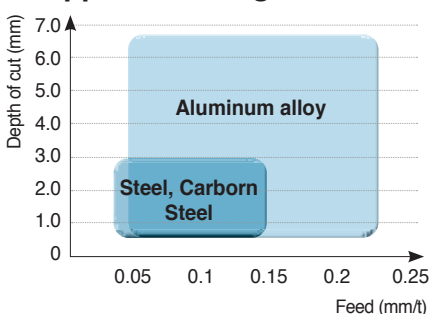


Through coolant system

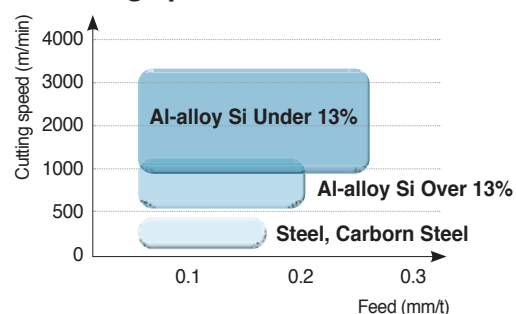
- Exclusively designed coolant bolt and cover provide excellent coolant action and chip evacuation for improved tool life
- Exact coolant direction to cutting area
- Exclusive coolant bolt and cover are sold separately. Through coolant arbor is required



Application range



Cutting speed



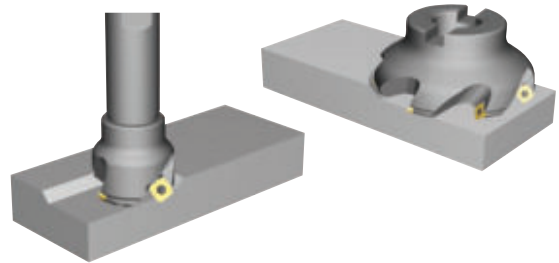
Max. available revolution

Cutter diameter	Max. revolution (rpm)
Ø63	20,000
Ø80	16,000
Ø100	13,000
Ø125	10,000
Ø160	8,000
Ø200	6,500
Ø250	5,000
Ø315	4,000

Future Mill (FMA)

Features

- General milling cutter for high productivity
- Adjustable pitch of cutter and various chip breaker offer wide application range.
- Light cutter body allows high speed cutting and can be used in low horse power machine
- Smooth cutting with low cutting load is accomplished with high-rake angle



Features of chip breaker

Insert	Cutting-edge	Uses	Features
None C/B		Light cutting	Superior surface roughness at finishing due to ground type cermet insert
MF		Light cutting	Superior cutting quality for light and difficult-to-cut material machining through the low cutting load of chip breaker
MM		General cutting	Suitable for various cutting due to special shape design for general cutting
MR		Roughing	Tough cutting-edge provides stable cutting performance in severe interruption
MA		For aluminum	Superior cutting quality for aluminum due to sharp cutting-edge and buffed surface - S□ET-MA: Sharp cutting-edge due to high accurate grinding - S□XT-MA: Suitable cutting-edge for roughing

Recommended cutting condition

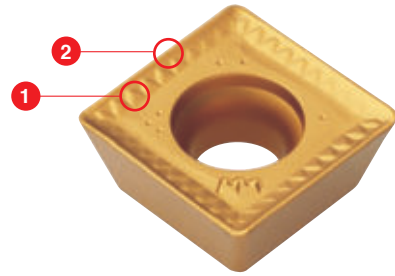
ISO	Grades	vc (m/min)	MF	MM	MR	MA
			fz (mm/t)	fz (mm/t)	fz (mm/t)	fz (mm/t)
P	NC5330	210~350	0.05~0.20	0.10~0.30	0.10~0.30	-
	NCM325	190~310	0.05~0.20	0.10~0.30	0.10~0.30	-
	PC3700	160~270	0.05~0.20	0.10~0.30	0.10~0.30	-
M	PC9530	90~150	0.05~0.15	0.10~0.30	-	-
	NCM335	70~120	0.05~0.15	0.10~0.30	-	-
K	PC5300	110~180	0.05~0.20	0.10~0.30	-	-
N	H01	260~440	-	-	-	0.10~0.35



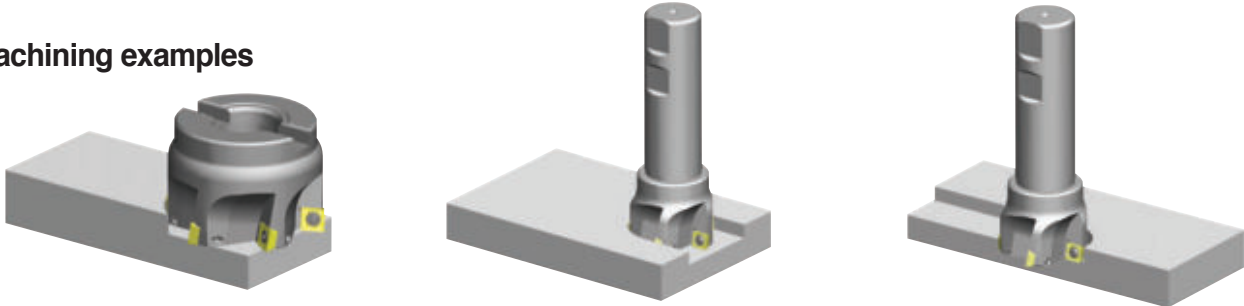
Future Mill (FMP)

Features

- The strong cutting-edge ensures excellent tool life in high feed and high speed, deep depth of cut, with low cutting loads
- Optimal grades for most workpieces make high efficiency cutting possible
- Unique chip breaker makes good chip evacuation and lower cutting loads (1)
- Innovative curve cutting-edge lowers cutting load and provides a stronger cutting-edge (2)



Machining examples



Features of chip breaker

- Innovative special cutting-edge and chip breaker design ensures ideal 90° cutting and low cutting load
- Various applications are available with multi functional cutters (Facing, Slotting, Shouldering)
- Improved tool life due to special coated grades
- Superior cutting quality at deep cutting depth through the low cutting load and strong cutting-edge

Recommended C/B and grade as per workpiece

Insert	Cutting-edge	Uses	Recommended C/B and grade as per workpiece (●: 1 st)										
			Low carbon steel/Mild steel		High carbon steel/Mild steel		Stainless steel		Cast iron		Aluminum alloy		
			C/B	Grades	C/B	Grades	C/B	Grades	C/B	Grades	C/B	Grades	
MF			Low cutting load type	●	○ NCM325 ○ NC5330 ● NCM335		● NCM325 ○ NC5330 ○ NCM335	●	○ NCM325 ○ NC5330 ● NCM335	●	● PC6510 ○ PC215K	-	-
MM			Reinforced cutting edge type		○ NCM325 ○ NC5330 ● NCM335		● NCM325 ○ NC5330 ○ NCM335		○ NCM325 ○ NC5330 ● NCM335		● PC6510 ○ PC215K	-	-
MA			Sharp cutting edge type	-	-	-	-	-	-	-	-	●	○ H01 ○ G10

Recommended cutting condition

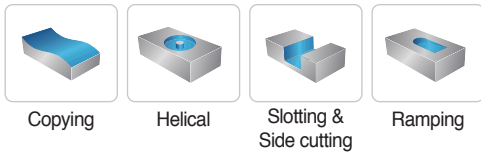
ISO	Cutting Speed vc (m/min)							
	CVD Coated		PVD Coated				Carbide	
	NCM325	NCM335	PC3700	PC6510	PC5300	PC9530	PC5400	H01
P	190~310	180~290	160-270	-	150-240	-	130-210	-
M	110~180	100~160	-	-	90-150	90-150	70-120	-
K	-	-	-	140-230	120-200	-	100-160	-
N	-	-	-	-	-	-	-	260-440

Future Mill (FMR)

Features

- Wide coverage for medium to roughing, general steel to high hardness mold materials
- 2 step shape of insert provides strong clamping and can minimize components to replace the shim
- 4-8 cutting-edge available per insert (Inscribed circle 05, 06, 07, 08, 10, 12, 16, 20)
- Uneven flute spacing prevents vibration on high speed applications and provides more stable machining
- Precise design of the insert seat prevents insert from chattering
- Special design of the insert bottom prevents movement and chatter of insert
- Easy to change cutting-edge due to the rotation prevention design of the insert

Uses



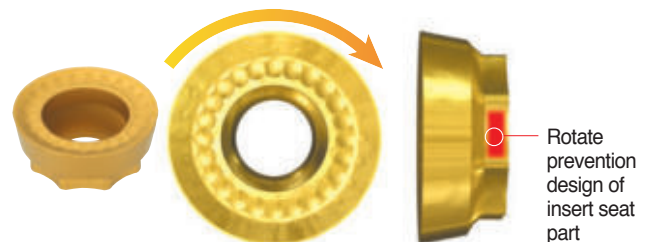
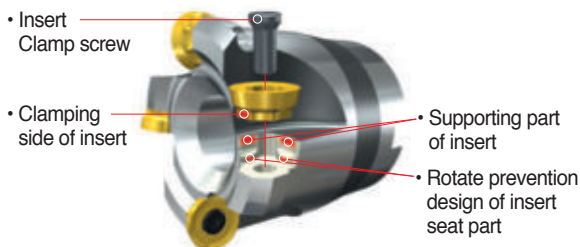
FMR Insert cutting-edge shape

Designation	RDHW□□□□M0F	RDHW□□□□M0E	RDHW□□□□M0S
Cutting edge shape (G class)			

Features of chip breaker

Insert	Cutting-edge	Uses	Features
MF		Light cutting	Low cutting resistance chip breaker design guarantees long tool life good performance at finishing and difficult-to-cut material machining
MM		General	Suitable for general milling at wide application range
MA		Aluminum	Sharp cutting-edge and buffed top face for aluminum machining prevent welding and control chip flow

Clamping system

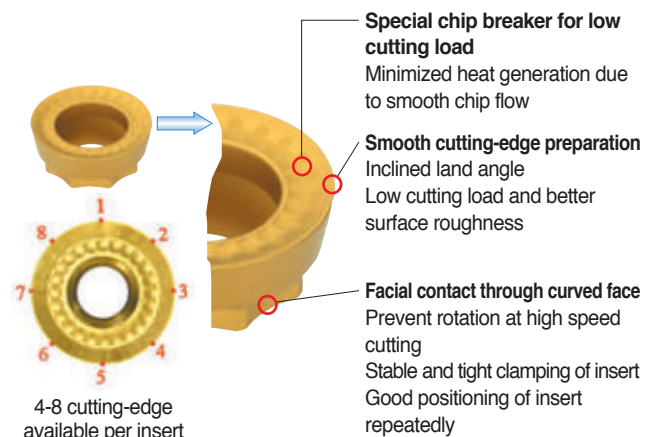
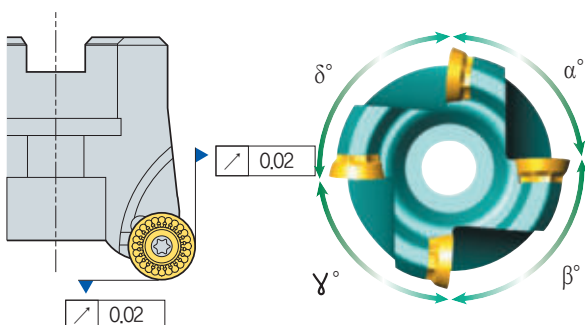


FMR□3000 type
FMR□4000 type

FMR□5000 type
FMR□6000 type

RDKT10T3M0-□□
RDKT1204M0-□□

RDKT1605M0-MM
RDKT2006M0-MM



Good surface finish due to the precise design of insert seat part of cutter

Uneven flute spacing prevents vibration at high speed application and provides stable machining

4-8 cutting-edge available per insert

Special chip breaker for low cutting load
Minimized heat generation due to smooth chip flow

Smooth cutting-edge preparation
Inclined land angle
Low cutting load and better surface roughness

Facial contact through curved face
Prevent rotation at high speed cutting
Stable and tight clamping of insert
Good positioning of insert repeatedly



Future Mill (FMR)

Chip removal rate (cm³/min)

Workpiece	Grades	Ø8	Ø10	Ø12	Ø15	Ø16	Ø20	Ø21	Ø25	Ø26	Ø32	Ø33	Ø40	Ø50	Ø63	Ø80	Ø100	Ø125	Ø160	
P	General structure steel (under 200HB)	4.97	9.94	9.94	14.92	31.83	31.83	47.74	47.74	47.74	71.61	38.19	95.49	119.36	143.23	167.11	190.98	133.69	509.29	
		vc = 250, fz = 0.25, ap = 0.5, ae = 0.5D		vc = 300, fz = 0.4, ap = 1.0, ae = 0.5D		vc = 250, fz = 0.4, ap = 1.5, ae = 0.5D														vc = 200, fz = 0.5, ap = 4.0, ae = 0.5D
	General carbon steel (under 30 HRC)	3.97	7.95	7.95	11.93	25.46	25.46	38.19	38.19	38.19	57.29	38.19	76.39	95.49	114.59	133.69	152.78	133.69	458.36	
		vc = 200, fz = 0.25, ap = 0.5, ae = 0.5D		vc = 250, fz = 0.4, ap = 1.0, ae = 0.5D		vc = 200, fz = 0.4, ap = 1.5, ae = 0.5D														vc = 180, fz = 0.5, ap = 4.0, ae = 0.5D
	High carbon steel, Alloy steel (30~40 HRC)	PC3700	2.86	5.72	5.72	8.59	22.91	22.91	34.37	34.37	34.37	51.56	34.37	68.75	85.94	103.13	120.32	137.5	120.32	407.43
			vc = 180, fz = 0.20, ap = 0.5, ae = 0.5D		vc = 200, fz = 0.4, ap = 1.0, ae = 0.5D		vc = 180, fz = 0.4, ap = 1.5, ae = 0.5D													
High carbon steel, Alloy steel (40~50 HRC)	PC5300	1.24	2.48	2.48	3.72	11.45	11.45	14.32	17.18	14.32	21.48	14.32	28.64	35.8	42.97	50.13	57.29	50.13	249.55	
		vc = 130, fz = 0.15, ap = 0.4, ae = 0.5D		vc = 170, fz = 0.3, ap = 0.9, ae = 0.5D		vc = 150, fz = 0.3, ap = 1.0, ae = 0.5D														vc = 140, fz = 0.4, ap = 3.5, ae = 0.5D
Alloy steel (over 50 HRC)	PC5300	0.95	1.9	1.9	2.86	7.63	7.63	9.54	11.45	9.54	14.32	9.54	19.09	23.87	28.64	33.42	38.19	33.42	152.78	
		vc = 100, fz = 0.15, ap = 0.4, ae = 0.5D		vc = 130, fz = 0.3, ap = 0.9, ae = 0.5D		vc = 100, fz = 0.3, ap = 1.0, ae = 0.5D														vc = 100, fz = 0.4, ap = 3.0, ae = 0.5D
M	Stainless steel	PC5300	2.06	4.13	4.13	6.2	16.55	16.55	12.41	24.82	12.41	18.62	12.41	24.82	31.03	37.24	43.44	49.65	43.44	331.04
			vc = 130, fz = 0.20, ap = 0.5, ae = 0.5D		vc = 200, fz = 0.2, ap = 1.0, ae = 0.5D		vc = 100, fz = 0.3, ap = 1.0, ae = 0.5D													
K	Cast iron	PC5300	2.86	5.72	5.72	8.59	14.32	14.32	21.48	21.48	21.48	32.22	21.48	42.97	53.71	64.45	75.2	85.94	75.2	366.69
			vc = 180, fz = 0.20, ap = 0.5, ae = 0.5D		vc = 180, fz = 0.2, ap = 1.0, ae = 0.5D		vc = 180, fz = 0.2, ap = 1.5, ae = 0.5D													

Required machine power (P_{KW} = 0.75 x P_{HP})

• RDKT10

Workpiece	Grades	Ø21	Ø25	Ø26	Ø32	Ø40	Ø50	Ø63	Ø80	Ø100	Cutting condition				
											vc	fz	ap	ae	
P	General structure steel (under 200HB) General carbon steel (under 30 HRC) High carbon steel, Alloy steel (30~40 HRC) High carbon steel, Alloy steel (40~50 HRC) Alloy steel (over 50 HRC)	PC3700 PC5300	2.2	2.2	2.2	3.3	4.4	5.5	6.6	7.7	8.8	250	0.4	1.5	0.5D
			2.1	2.1	2.1	3.1	4.1	5.2	6.2	7.3	8.3	200	0.4	1.5	0.5D
			2.2	2.2	2.2	3.3	4.5	5.6	6.7	7.9	9	180	0.4	1.5	0.5D
			1.1	1.1	1.1	1.6	2.1	2.6	3.2	3.7	4.2	150	0.3	1.0	0.5D
			0.7	0.7	0.7	1.1	1.4	1.7	2.1	2.4	2.8	100	0.3	1.0	0.5D
M	Stainless steel	PC5300	0.6	0.6	0.6	0.8	1.2	1.5	1.7	2	2.3	130	0.2	1.5	0.5D
K	Cast iron	PC5300	0.6	0.6	0.6	0.9	1.2	1.5	1.8	2.1	2.4	180	0.2	1.5	0.5D

• The figures in the above chart means P_{HP} value.

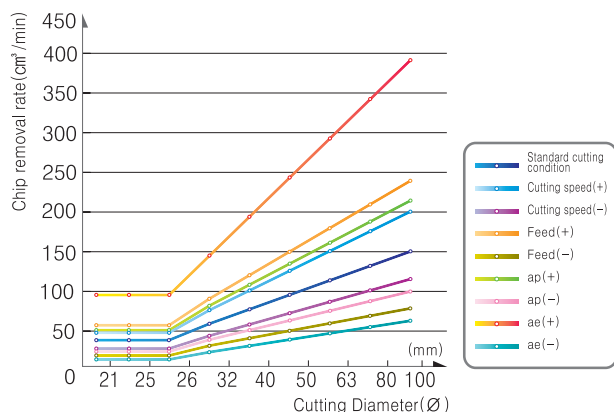
• RDKT12

Workpiece	Grades	Ø32	Ø33	Ø40	Ø50	Ø63	Ø80	Ø100	Ø125	Cutting condition				
										vc	fz	ap	ae	
P	General structure steel (under 200HB) General carbon steel (under 30 HRC) High carbon steel, Alloy steel (30~40 HRC) High carbon steel, Alloy steel (40~50 HRC) Alloy steel (over 50 HRC)	PC3700 PC5300	1.7	1.7	2.6	3.5	3.5	4.4	5.3	6.1	200	0.4	1.5	0.5D
			2	2	3.1	4.1	2.6	5.2	6.2	7.2	180	0.4	1.5	0.5D
			2.2	2.2	3.3	4.4	2.8	5.6	6.7	7.8	160	0.4	1.5	0.5D
			1	1	1.5	1.6	2.1	2.6	3.1	3.6	140	0.3	1.0	0.5D
			0.7	0.7	1	1.4	0.8	1.7	2.1	2.4	100	0.3	1.0	0.5D
M	Stainless steel	PC5300	0.5	0.5	0.8	1.1	0.7	1.4	1.7	2	130	0.2	1.5	0.5D
K	Cast iron	PC5300	0.6	0.6	0.9	1.2	0.7	1.5	1.8	2.1	180	0.2	1.5	0.5D

• The figures in the above chart means P_{HP} value.

Chip removal rate by cutting condition

• Used insert: RDKT10



Variation of cutting condition

Standard	ISO			
	vc = 200	fz = 0.4	ap = 1.5	ae = 0.5D
Speed (+)	250			
Speed (-)	150			
Feed (+)	0.6			
Feed (-)	0.2			
ap (+)	2			
ap (-)	1			
ae (+)	D			
ae (-)	0.2D			



Recommended cutting condition

• Side milling, slotting, ramping, copying

Workpiece	Hardness	Grades	Cutting speed (m/min)	FMR1000		FMR1500		FMR2000		FMR2500		FMR3000		FMR4000		FMR5000		FMR6000	
				ap (mm)	fz (mm/t)	ap (mm)	fz (mm/t)	ap (mm)	fz (mm/t)	ap (mm)	fz (mm/t)	ap (mm)	fz (mm/t)	ap (mm)	fz (mm/t)	ap (mm)	fz (mm/t)	ap (mm)	fz (mm/t)
Carbon steel	200HB ≤	PC5300	280	≤ 1.0	≤ 0.4	≤ 1.2	≤ 0.4	≤ 1.5	≤ 0.4	≤ 1.7	≤ 0.4	≤ 2.0	≤ 0.5	≤ 2.4	≤ 0.6	≤ 3.0	≤ 0.7	≤ 4.0	≤ 0.8
		PC5400	245	≤ 0.7	≤ 0.4	≤ 1.2	≤ 0.4	≤ 1.5	≤ 0.4	≤ 1.7	≤ 0.4	≤ 2.0	≤ 0.5	≤ 2.4	≤ 0.6	≤ 3.0	≤ 0.7	≤ 4.0	≤ 0.8
	30HRC ≤	PC5300	250	≤ 0.7	≤ 0.2	≤ 0.9	≤ 0.2	≤ 1.2	≤ 0.2	≤ 1.5	≤ 0.2	≤ 1.7	≤ 0.3	≤ 2.0	≤ 0.4	≤ 2.7	≤ 0.5	≤ 3.7	≤ 0.6
Alloy steel	30~40HRC	PC5300	195	≤ 0.7	≤ 0.2	≤ 0.9	≤ 0.2	≤ 1.2	≤ 0.2	≤ 1.5	≤ 0.2	≤ 1.7	≤ 0.3	≤ 2.0	≤ 0.4	≤ 2.7	≤ 0.5	≤ 3.7	≤ 0.6
		PC5400	170	≤ 0.7	≤ 0.2	≤ 0.9	≤ 0.2	≤ 1.2	≤ 0.2	≤ 1.5	≤ 0.2	≤ 1.7	≤ 0.3	≤ 2.0	≤ 0.4	≤ 2.7	≤ 0.5	≤ 3.7	≤ 0.6
High alloy steel (alloy constituent > 5%)	40~50HRC	PC5300	150	≤ 0.7	≤ 0.2	≤ 0.9	≤ 0.2	≤ 1.2	≤ 0.2	≤ 1.5	≤ 0.2	≤ 1.7	≤ 0.3	≤ 2.0	≤ 0.4	≤ 2.7	≤ 0.5	≤ 3.7	≤ 0.6
		PC5400	130	≤ 0.7	≤ 0.2	≤ 0.9	≤ 0.2	≤ 1.2	≤ 0.2	≤ 1.5	≤ 0.2	≤ 1.7	≤ 0.3	≤ 2.0	≤ 0.4	≤ 2.7	≤ 0.5	≤ 3.7	≤ 0.6
		Tensile strength 350MPa ≤	PC5400	105	≤ 0.7	≤ 0.2	≤ 0.9	≤ 0.2	≤ 1.2	≤ 0.2	≤ 1.5	≤ 0.2	≤ 1.7	≤ 0.3	≤ 2.0	≤ 0.4	≤ 2.7	≤ 0.5	≤ 3.7
Stainless steel	270HB ≤	PC5300	130	≤ 0.7	≤ 0.2	≤ 0.9	≤ 0.2	≤ 1.2	≤ 0.2	≤ 1.5	≤ 0.2	≤ 1.7	≤ 0.3	≤ 2.0	≤ 0.4	≤ 2.7	≤ 0.5	≤ 3.7	≤ 0.6
		PC5400	110	≤ 0.7	≤ 0.2	≤ 0.9	≤ 0.2	≤ 1.2	≤ 0.2	≤ 1.5	≤ 0.2	≤ 1.7	≤ 0.3	≤ 2.0	≤ 0.4	≤ 2.7	≤ 0.5	≤ 3.7	≤ 0.6
Cast iron, Ductile cast iron	Low tensile	PC5300	145	≤ 0.7	≤ 0.4	≤ 1.2	≤ 0.4	≤ 1.5	≤ 0.4	≤ 1.7	≤ 0.4	≤ 2.0	≤ 0.5	≤ 2.4	≤ 0.6	≤ 3.0	≤ 0.7	≤ 4.0	≤ 0.8
		PC5400	110	≤ 0.7	≤ 0.4	≤ 1.2	≤ 0.4	≤ 1.5	≤ 0.4	≤ 1.7	≤ 0.4	≤ 2.0	≤ 0.5	≤ 2.4	≤ 0.6	≤ 3.0	≤ 0.7	≤ 4.0	≤ 0.8

• Plunging

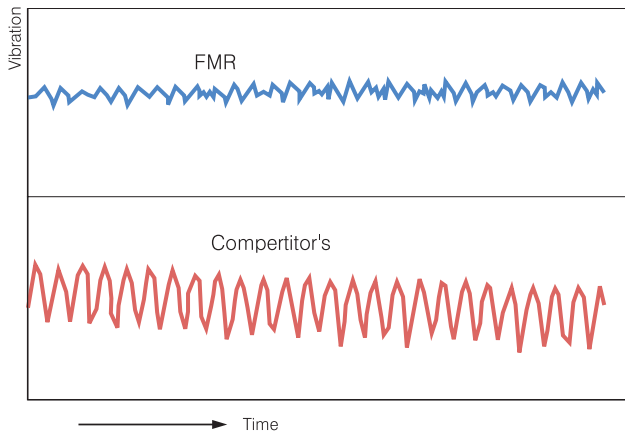
Workpiece	Hardness	Grades	Cutting speed (m/min)	FMR1000		FMR1500		FMR2000		FMR2500		FMR3000		FMR4000		FMR5000		FMR6000	
				ap (mm)	fz (mm/t)	ap (mm)	fz (mm/t)	ap (mm)	fz (mm/t)	ap (mm)	fz (mm/t)	ap (mm)	fz (mm/t)	ap (mm)	fz (mm/t)	ap (mm)	fz (mm/t)	ap (mm)	fz (mm/t)
Carbon steel	200HB ≤	PC5300	280	≤ 2.5	≤ 0.2	≤ 3.0	≤ 0.2	≤ 3.5	≤ 0.2	≤ 4.0	≤ 0.2	≤ 5.0	≤ 0.3	≤ 6.0	≤ 0.4	≤ 8.0	≤ 0.5	≤ 10.0	≤ 0.6
		PC5400	245	≤ 2.5	≤ 0.2	≤ 3.0	≤ 0.2	≤ 3.5	≤ 0.2	≤ 4.0	≤ 0.2	≤ 5.0	≤ 0.3	≤ 6.0	≤ 0.4	≤ 8.0	≤ 0.5	≤ 10.0	≤ 0.6
	30HRC ≤	PC5300	250	≤ 2.5	≤ 0.2	≤ 3.0	≤ 0.2	≤ 3.5	≤ 0.2	≤ 4.0	≤ 0.2	≤ 5.0	≤ 0.3	≤ 6.0	≤ 0.4	≤ 8.0	≤ 0.5	≤ 10.0	≤ 0.6
Alloy steel	30~40HRC	PC5300	195	≤ 2.5	≤ 0.1	≤ 3.0	≤ 0.1	≤ 3.5	≤ 0.1	≤ 4.0	≤ 0.1	≤ 5.0	≤ 0.2	≤ 6.0	≤ 0.3	≤ 8.0	≤ 0.4	≤ 10.0	≤ 0.5
		PC5400	170	≤ 2.5	≤ 0.1	≤ 3.0	≤ 0.1	≤ 3.5	≤ 0.1	≤ 4.0	≤ 0.1	≤ 5.0	≤ 0.2	≤ 6.0	≤ 0.3	≤ 8.0	≤ 0.4	≤ 10.0	≤ 0.5
High alloy steel (alloy constituent > 5%)	40~50HRC	PC5300	150	≤ 2.5	≤ 0.1	≤ 3.0	≤ 0.1	≤ 3.5	≤ 0.1	≤ 4.0	≤ 0.1	≤ 5.0	≤ 0.2	≤ 6.0	≤ 0.3	≤ 8.0	≤ 0.4	≤ 10.0	≤ 0.5
		PC5400	130	≤ 2.5	≤ 0.1	≤ 3.0	≤ 0.1	≤ 3.5	≤ 0.1	≤ 4.0	≤ 0.1	≤ 5.0	≤ 0.2	≤ 6.0	≤ 0.3	≤ 8.0	≤ 0.4	≤ 10.0	≤ 0.5
		Tensile strength 350MPa ≤	PC5400	105	≤ 2.5	≤ 0.1	≤ 3.0	≤ 0.1	≤ 3.5	≤ 0.1	≤ 4.0	≤ 0.1	≤ 5.0	≤ 0.2	≤ 6.0	≤ 0.3	≤ 8.0	≤ 0.4	≤ 10.0
Stainless steel	270HB ≤	PC5300	130	≤ 2.5	≤ 0.1	≤ 3.0	≤ 0.1	≤ 3.5	≤ 0.1	≤ 4.0	≤ 0.1	≤ 5.0	≤ 0.2	≤ 6.0	≤ 0.3	≤ 8.0	≤ 0.4	≤ 10.0	≤ 0.5
		PC5400	110	≤ 2.5	≤ 0.1	≤ 3.0	≤ 0.1	≤ 3.5	≤ 0.1	≤ 4.0	≤ 0.1	≤ 5.0	≤ 0.2	≤ 6.0	≤ 0.3	≤ 8.0	≤ 0.4	≤ 10.0	≤ 0.5
Cast iron, Ductile cast iron	Low tensile	PC5300	145	≤ 2.5	≤ 0.2	≤ 3.0	≤ 0.2	≤ 3.5	≤ 0.2	≤ 4.0	≤ 0.2	≤ 5.0	≤ 0.3	≤ 6.0	≤ 0.4	≤ 8.0	≤ 0.5	≤ 10.0	≤ 0.6
		PC5400	110	≤ 2.5	≤ 0.2	≤ 3.0	≤ 0.2	≤ 3.5	≤ 0.2	≤ 4.0	≤ 0.2	≤ 5.0	≤ 0.3	≤ 6.0	≤ 0.4	≤ 8.0	≤ 0.5	≤ 10.0	≤ 0.6

• Helical cutting

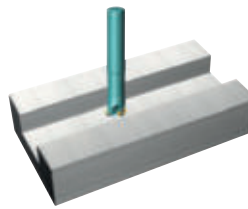
Workpiece	Hardness	Grades	Cutting speed (m/min)	FMR1000		FMR1500		FMR2000		FMR2500		FMR3000		FMR4000		FMR5000		FMR6000	
				ap (mm)	fz (mm/t)	ap (mm)	fz (mm/t)	ap (mm)	fz (mm/t)	ap (mm)	fz (mm/t)	ap (mm)	fz (mm/t)	ap (mm)	fz (mm/t)	ap (mm)	fz (mm/t)	ap (mm)	fz (mm/t)
Carbon steel	200HB ≤	PC5300	280	≤ 1.0	≤ 0.2	≤ 1.0	≤ 0.2	≤ 1.0	≤ 0.2	≤ 1.0	≤ 0.2	≤ 2.0	≤ 0.3	≤ 2.0	≤ 0.4	≤ 4.0	≤ 0.5	≤ 4.0	≤ 0.6
		PC5400	245	≤ 0.7	≤ 0.2	≤ 0.7	≤ 0.2	≤ 0.7	≤ 0.2	≤ 0.7	≤ 0.2	≤ 2.0	≤ 0.3	≤ 2.0	≤ 0.4	≤ 4.0	≤ 0.5	≤ 4.0	≤ 0.6
	30HRC ≤	PC5300	250	≤ 0.7	≤ 0.2	≤ 0.7	≤ 0.2	≤ 0.7	≤ 0.2	≤ 0.7	≤ 0.2	≤ 2.0	≤ 0.3	≤ 2.0	≤ 0.4	≤ 4.0	≤ 0.5	≤ 4.0	≤ 0.6
Alloy steel	30~40HRC	PC5300	195	≤ 0.7	≤ 0.1	≤ 0.7	≤ 0.1	≤ 0.7	≤ 0.1	≤ 0.7	≤ 0.1	≤ 1.7	≤ 0.2	≤ 1.7	≤ 0.3	≤ 3.7	≤ 0.4	≤ 3.7	≤ 0.5
		PC5400	170	≤ 0.7	≤ 0.1	≤ 0.7	≤ 0.1	≤ 0.7	≤ 0.1	≤ 0.7	≤ 0.1	≤ 1.7	≤ 0.2	≤ 1.7	≤ 0.3	≤ 3.7	≤ 0.4	≤ 3.7	≤ 0.5
High alloy steel (alloy constituent > 5%)	40~50HRC	PC5300	150	≤ 0.7	≤ 0.1	≤ 0.7	≤ 0.1	≤ 0.7	≤ 0.1	≤ 0.7	≤ 0.1	≤ 1.7	≤ 0.2	≤ 1.7	≤ 0.3	≤ 3.7	≤ 0.4	≤ 3.7	≤ 0.5
		PC5400	130	≤ 0.7	≤ 0.1	≤ 0.7	≤ 0.1	≤ 0.7	≤ 0.1	≤ 0.7	≤ 0.1	≤ 1.7	≤ 0.2	≤ 1.7	≤ 0.3	≤ 3.7	≤ 0.4	≤ 3.7	≤ 0.5
		Tensile strength 350MPa ≤	PC5400	105	≤ 0.7	≤ 0.1	≤ 0.7	≤ 0.1	≤ 0.7	≤ 0.1	≤ 0.7	≤ 0.1	≤ 1.7	≤ 0.2	≤ 1.7	≤ 0.3	≤ 3.7	≤ 0.4	≤ 3.7
Stainless steel	270HB ≤	PC5300	130	≤ 0.7	≤ 0.1	≤ 0.7	≤ 0.1	≤ 0.7	≤ 0.1	≤ 0.7	≤ 0.1	≤ 1.7	≤ 0.2	≤ 1.7	≤ 0.3	≤ 3.7	≤ 0.4	≤ 3.7	≤ 0.5
		PC5400	110	≤ 0.7	≤ 0.1	≤ 0.7	≤ 0.1	≤ 0.7	≤ 0.1	≤ 0.7	≤ 0.1	≤ 1.7	≤ 0.2	≤ 1.7	≤ 0.3	≤ 3.7	≤ 0.4	≤ 3.7	≤ 0.5
Cast iron, Ductile cast iron	Low tensile	PC5300	145	≤ 1.0	≤ 0.2	≤ 1.0	≤ 0.2	≤ 1.0	≤ 0.2	≤ 1.0	≤ 0.2	≤ 2.0	≤ 0.3	≤ 2.0	≤ 0.4	≤ 4.0	≤ 0.5	≤ 4.0	≤ 0.6
		PC5400	110	≤ 1.0	≤ 0.2	≤ 1.0	≤ 0.2	≤ 1.0	≤ 0.2	≤ 1.0	≤ 0.2	≤ 2.0	≤ 0.3	≤ 2.0	≤ 0.4	≤ 4.0	≤ 0.5	≤ 4.0	≤ 0.6

Future Mill (FMR)

FMR Vibration test



Machining example



- **Workpiece** STD11
- **Cutting condition**
 - vc (m/min) = 200
 - fz (mm/t) = 0.40
 - ap (mm) = 2.0
 - ae (mm) = 4.0
- **Tools**
 - Insert** RDKT10T3M0-MM (PC3500)
 - Holder** FMRS3032RD-S

Cutting condition formulas for milling

Cutting speed	RPM
---------------	-----

$$vc = \frac{\pi \times D \times n}{1000} \text{ (m/min)}$$

$$n = \frac{vc \times 1000}{\pi \times D} \text{ (min}^{-1}\text{)}$$

Feed (per tooth)	Feed (per minute)
------------------	-------------------

$$fz = \frac{vf}{Z \times n} \text{ (mm/t)}$$

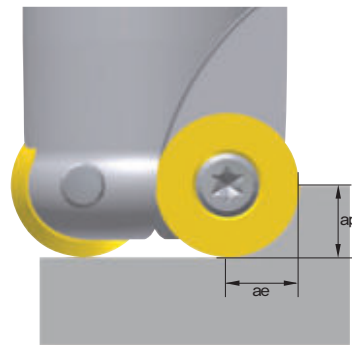
$$vf = fz \times n \times z \text{ (mm/min)}$$

Chip removal rate	Required machine power
-------------------	------------------------

$$Q = \frac{ap \times ae \times vf}{1000} \text{ (cm}^3\text{/min)}$$

$$P_{kw} = \frac{Q \times kc}{60 \times 102 \times \eta} \text{ (kW)}$$

$$P_{hp} = \frac{P_c}{0.75} \text{ (hp)}$$



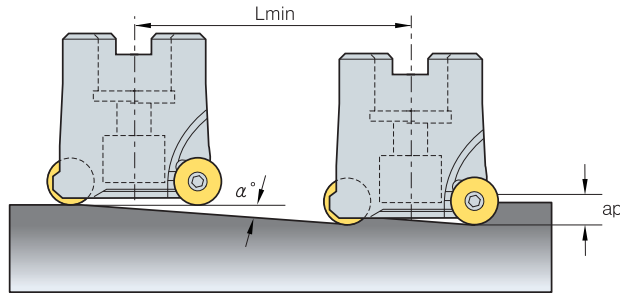
vc = Cutting speed (m/min)	Pkw = Required machine power (kW)
n = Revolution per a minute (min ⁻¹)	Php = Horsepower requirement (hp)
D = Cutting diameter (mm)	Q = Chip removal amount (cm ³ /min)
De = Efficient cutting diameter (mm)	ap = Depth of cut (mm)
vf = Feed per a minute (mm/min)	ae = Width of cut (mm)
fz = Feed per tooth (mm/t)	kc = Specific cutting resistance (MPa)
z = Number of tooth	η = Mechanical efficiency (%)
Pc = Power requirement (kW)	

Feed as per cutting depth

Designation	Chip breaker	Depth of cut (mm)									
		0.2~0.5	0.5~1.0	2.0	3.0	4.0	5.0	6.0	7.0	8.0	
RDHW0501M0	-	0.25	0.15	-	-	-	-	-	-	-	-
RDHW06T1M0	-	0.30	0.20	0.10	-	-	-	-	-	-	-
RDHW0702M0	-	0.35	0.25	0.10	0.07	-	-	-	-	-	-
RDHW0803M0	-	0.40	0.30	0.15	0.01	-	-	-	-	-	-
RDKT10T3M0 -	MF/MM	-	0.40	0.35	0.30	0.20	-	-	-	-	-
RDKT1204M0 -	MF/MM	-	0.50	0.45	0.30	0.25	0.22	-	-	-	-
RDHW1605M0	-	-	0.60	0.50	0.45	0.35	0.30	0.20	0.10	-	-
RDHW2006M0	-	-	-	0.60	0.50	0.40	0.30	0.25	0.15	0.10	-
RDKT1605M0 -	MM	-	0.60	0.50	0.45	0.35	0.30	0.20	0.10	-	-
RDKT2006M0 -	MM	-	-	0.60	0.50	0.40	0.30	0.25	0.15	0.10	-

Future Mill (FMR)

Ramping technical data



$$L_{min} = \frac{ap}{\tan \alpha^\circ} \text{ (mm)}$$

※ Lmin: Min. inclination cutting length
 α° : Max. ramping angle
 ap: Depth of cut

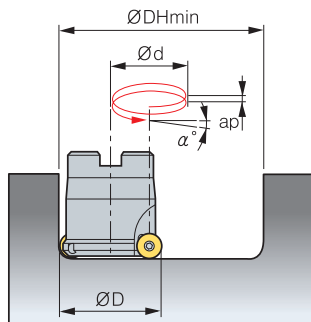
(mm)

Section	Tool dia.	Ramping angle α° (Max)	Cutting length L (mm) by ramping angle									
			ap = 1	ap = 2	ap = 2.5	ap = 3	ap = 3.5	ap = 4	ap = 5	ap = 6	ap = 8	ap = 10
FMR1000	08	18.14	3	6	8	-	-	-	-	-	-	-
	10	11.7	5	10	12	-	-	-	-	-	-	-
	12	8.43	7	13	17	-	-	-	-	-	-	-
	15	5.93	10	19	24	-	-	-	-	-	-	-
FMR1500	10	20.67	21	5	7	8	-	-	-	-	-	-
	12	10.05	10	11	14	17	-	-	-	-	-	-
	16	6.12	6	19	23	28	-	-	-	-	-	-
	20	4.36	4	26	33	39	-	-	-	-	-	-
FMR2000	15	9.42	6	12	15	18	21	-	-	-	-	-
	20	5.85	10	20	24	29	34	-	-	-	-	-
FMR2500	16	13.7	4	8	10	12	14	16	-	-	-	-
	20	9.29	6	12	15	18	21	24	-	-	-	-
	25	6.56	9	17	22	26	30	35	-	-	-	-
FMR3000	25	21.8	3	5	6	8	9	10	13	-	-	-
	32	13.24	4	9	11	13	15	17	21	-	-	-
	40	9.09	6	13	16	19	22	25	31	-	-	-
	50	6.52	9	17	22	26	31	35	44	-	-	-
	63	4.76	12	24	30	36	42	48	60	-	-	-
	80	3.52	16	33	41	49	57	65	81	-	-	-
FMR4000	100	2.69	21	43	53	64	74	85	106	-	-	-
	32	15.95	3	7	9	10	12	14	17	21	-	-
	40	10.3	6	11	14	17	19	22	28	33	-	-
	50	7.13	8	16	20	24	28	32	40	48	-	-
	63	5.08	11	22	28	34	39	45	56	67	-	-
	80	3.69	16	31	39	47	54	62	78	93	-	-
	100	2.79	21	41	51	62	72	82	103	123	-	-
FMR5000	125	2.14	27	54	67	80	94	107	134	161	-	-
	40	7.4	8	15	19	23	27	31	38	46	62	-
	50	5.22	11	22	27	33	38	44	55	66	88	-
	63	3.79	15	30	38	45	53	60	75	91	121	-
	80	2.97	19	39	48	58	67	77	96	116	154	-
	100	2.09	27	55	69	82	96	110	137	164	219	-
FMR6000	125	1.63	35	70	88	105	123	141	176	211	281	-
	40	7.44	8	15	19	23	27	31	38	46	61	77
	50	4.97	11	23	29	34	40	46	57	69	92	46
	63	3.69	16	31	39	47	54	62	78	93	124	62
	80	2.72	21	42	53	63	74	84	105	126	168	84
	100	2.12	27	54	68	81	95	108	135	162	216	108



Future Mill (FMR)

Helical cutting technical data - ØDHmin



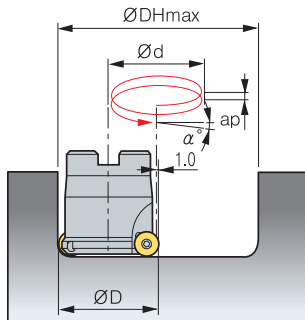
- ØD = Tool dia. (mm), ØDHmin, Max = Min, Max diameter (mm)
- Ød = Tool path (mm)
- ØDHmin (Min diameter) = ØD × 2 - Insert size, ØDHmax (Max diameter) = ØD × 2 - 2
- Ød (Tool path) = ØDHmin, Max - ØD

(mm)

Section	Insert	Tool dia.	ØDHmin	Ød	Ramping angle (α°)									
					ap = 1	ap = 2	ap = 2.5	ap = 3	ap = 3.5	ap = 4	ap = 5	ap = 6	ap = 8	ap = 10
FMR1000	5	08	11	3	6.11	12.35	15.57	-	-	-	-	-	-	-
	5	10	15	5	3.65	7.34	7.34	-	-	-	-	-	-	-
	5	12	19	7	2.61	5.23	5.23	-	-	-	-	-	-	-
	5	15	25	10	1.83	3.65	3.65	-	-	-	-	-	-	-
FMR1500	6	10	14	4	4.57	9.20	9.20	13.95	-	-	-	-	-	-
	6	12	18	6	3.04	6.11	6.11	9.20	-	-	-	-	-	-
	6	16	26	10	1.83	3.65	3.65	5.49	-	-	-	-	-	-
	6	20	34	14	1.30	2.61	2.61	3.92	-	-	-	-	-	-
FMR2000	7	15	23	8	2.28	4.57	4.57	6.88	8.04	-	-	-	-	-
	7	20	33	13	1.40	2.81	2.81	4.22	4.92	-	-	-	-	-
FMR2500	8	16	24	8	2.28	4.57	4.57	6.88	8.04	9.20	-	-	-	-
	8	20	32	12	1.52	3.04	3.04	4.57	5.34	6.11	-	-	-	-
	8	25	42	17	1.07	2.15	2.15	3.22	3.76	4.30	-	-	-	-
FMR3000	10	25	40	15	1.22	2.43	2.43	3.65	4.27	4.88	6.11	-	-	-
	10	32	54	22	0.83	1.66	1.66	2.49	2.91	3.32	4.15	-	-	-
	10	40	70	30	0.61	1.22	1.22	1.83	2.13	2.43	3.04	-	-	-
	10	50	90	40	0.46	0.91	0.91	1.37	1.60	1.83	2.28	-	-	-
	10	63	116	53	0.34	0.69	0.69	1.03	1.21	1.38	1.72	-	-	-
	10	80	150	70	0.26	0.52	0.52	0.78	0.91	1.04	1.30	-	-	-
FMR4000	12	32	52	20	0.91	1.83	1.83	2.74	3.20	3.65	4.57	5.49	-	-
	12	40	68	28	0.65	1.30	1.30	1.96	2.28	2.61	3.26	3.92	-	-
	12	50	88	38	0.48	0.96	0.96	1.44	1.68	1.92	2.40	2.88	-	-
	12	63	114	51	0.36	0.72	0.72	1.07	1.25	1.43	1.79	2.15	-	-
	12	80	148	68	0.27	0.54	0.54	0.81	0.94	1.07	1.34	1.61	-	-
	12	100	188	88	0.21	0.41	0.41	0.62	0.73	0.83	1.04	1.24	-	-
	12	125	238	113	0.16	0.32	0.32	0.48	0.57	0.65	0.81	0.97	-	-
FMR5000	16	40	64	24	0.76	1.52	1.52	2.28	2.66	3.04	3.81	4.57	6.11	-
	16	50	84	34	0.54	1.07	1.07	1.61	1.88	2.15	2.69	3.22	4.30	-
	16	63	110	47	0.39	0.78	0.78	1.16	1.36	1.55	1.94	2.33	3.11	-
	16	80	144	64	0.29	0.57	0.57	0.86	1.00	1.14	1.43	1.71	2.28	-
	16	100	184	84	0.22	0.43	0.43	0.65	0.76	0.87	1.09	1.30	1.74	-
FMR6000	20	50	80	30	0.61	1.22	1.22	1.83	2.13	2.43	3.04	3.65	4.88	6.11
	20	63	106	43	0.42	0.85	0.85	1.27	1.49	1.70	2.12	2.55	3.40	4.25
	20	80	140	60	0.30	0.61	0.61	0.91	1.06	1.22	1.52	1.83	2.43	3.04
	20	100	180	80	0.23	0.46	0.46	0.68	0.80	0.91	1.14	1.37	1.83	2.28
	20	125	230	105	0.17	0.35	0.35	0.52	0.61	0.70	0.87	1.04	1.39	1.74
	20	160	300	140	0.13	0.26	0.26	0.39	0.46	0.52	0.65	0.78	1.04	1.30

Future Mill (FMR)

Helical cutting technical data - ØDHmax



- ØD = Tool dia. (mm), ØDHmin, Max = Min, Max diameter (mm)
- Ød = Tool path (mm)
- ØDHmin (Min diameter) = ØD × 2 - Insert size, ØDHmax (Max diameter) = ØD × 2 - 2
- Ød (Tool path) = ØDHmin, Max - ØD

(mm)

Section	Insert	Tool dia.	ØDHmax	Ød	Ramping angle (α°)									
					ap = 1	ap = 2	ap = 2.5	ap = 3	ap = 3.5	ap = 4	ap = 5	ap = 6	ap = 8	ap = 10
FMR1000	5	08	14	6	3.04	6.11	7.65	-	-	-	-	-	-	-
	5	10	18	8	2.28	4.57	5.72	-	-	-	-	-	-	-
	5	12	22	10	1.83	3.65	4.57	-	-	-	-	-	-	-
	5	15	28	13	1.40	2.81	3.51	-	-	-	-	-	-	-
FMR1500	6	10	18	8	2.28	4.57	5.72	6.88	-	-	-	-	-	-
	6	12	22	10	1.83	3.65	4.57	5.49	-	-	-	-	-	-
	6	16	30	14	1.30	2.61	3.26	3.92	-	-	-	-	-	-
	6	20	38	18	1.01	2.03	2.54	3.04	-	-	-	-	-	-
FMR2000	7	15	28	13	1.40	2.81	3.51	4.22	4.92	-	-	-	-	-
	7	20	38	18	1.01	2.03	2.54	3.04	3.55	-	-	-	-	-
FMR2500	8	16	30	14	1.30	2.61	3.26	3.92	4.57	5.23	-	-	-	-
	8	20	38	18	1.01	2.03	2.54	3.04	3.55	4.06	-	-	-	-
	8	25	48	23	0.79	1.59	1.98	2.38	2.78	3.18	-	-	-	-
FMR3000	10	25	48	23	0.79	1.59	1.98	2.38	2.78	3.18	3.97	-	-	-
	10	32	62	30	0.61	1.22	1.52	1.83	2.13	2.43	3.04	-	-	-
	10	40	78	38	0.48	0.96	1.20	1.44	1.68	1.92	2.40	-	-	-
	10	50	98	48	0.38	0.76	0.95	1.14	1.33	1.52	1.90	-	-	-
	10	63	124	61	0.30	0.60	0.75	0.90	1.05	1.20	1.50	-	-	-
	10	80	158	78	0.23	0.47	0.58	0.70	0.82	0.94	1.17	-	-	-
	10	100	198	98	0.19	0.37	0.47	0.56	0.65	0.74	0.93	-	-	-
FMR4000	12	32	62	30	0.61	1.22	1.52	1.83	2.13	2.43	3.04	3.65	-	-
	12	40	78	38	0.48	0.96	1.20	1.44	1.68	1.92	2.40	2.88	-	-
	12	50	98	48	0.38	0.76	0.95	1.14	1.33	1.52	1.90	2.28	-	-
	12	63	124	61	0.30	0.60	0.75	0.90	1.05	1.20	1.50	1.80	-	-
	12	80	158	78	0.23	0.47	0.58	0.70	0.82	0.94	1.17	1.40	-	-
	12	100	198	98	0.19	0.37	0.47	0.56	0.65	0.74	0.93	1.12	-	-
	12	125	248	123	0.15	0.30	0.37	0.45	0.52	0.59	0.74	0.89	-	-
FMR5000	16	40	78	38	0.48	0.96	1.20	1.44	1.68	1.92	2.40	2.88	3.85	-
	16	50	98	48	0.38	0.76	0.95	1.14	1.33	1.52	1.90	2.28	3.04	-
	16	63	124	61	0.30	0.60	0.75	0.90	1.05	1.20	1.50	1.80	2.39	-
	16	80	158	78	0.23	0.47	0.58	0.70	0.82	0.94	1.17	1.40	1.87	-
	16	100	198	98	0.19	0.37	0.47	0.56	0.65	0.74	0.93	1.12	1.49	-
	16	125	248	123	0.15	0.30	0.37	0.45	0.52	0.59	0.74	0.89	1.19	-
FMR6000	20	50	98	48	0.38	0.76	0.95	1.14	1.33	1.52	1.90	2.28	3.04	3.81
	20	63	124	61	0.30	0.60	0.75	0.90	1.05	1.20	1.50	1.80	2.39	2.99
	20	80	158	78	0.23	0.47	0.58	0.70	0.82	0.94	1.17	1.40	1.87	2.34
	20	100	198	98	0.19	0.37	0.47	0.56	0.65	0.74	0.93	1.12	1.49	1.86
	20	125	248	123	0.15	0.30	0.37	0.45	0.52	0.59	0.74	0.89	1.19	1.48
	20	160	318	158	0.12	0.23	0.29	0.35	0.40	0.46	0.58	0.69	0.92	1.16



Future Mill series for mold making

FMR P-positive

- Stable clamping system enables stable machining and productivity
- Varied product line-up ensures wide application range
- Optimal shape and grade with high hardness for hard-to-cut material machining

Features

- P-positive relief angle (11°) ensures high rigidity and high machinability in die steel and high-resistant alloy machining
- Flat clearance face of insert prevents interference and revolution while machining
- Optimal grades and chip breakers for various workpieces
- Chip breaker
 - Concave shape ensures wide chip pocket and lowers cutting temperature
 - Clearance face for preventing rotation
 - Prevents rotation in machining
 - Divides corners
 - Prevents interference in high-feed machining
 - Ensures stable clamping
 - Through-coolant system
 - Superb chip evacuation
 - Low cutting heat ensures long tool life

Features of chip breaker

Insert	Cutting-edge	Uses	Features
MA		Aluminum machining	Optimal cutting-edge for aluminum machining and buffed surface ensure high machinability
ML		Titanium & Inconel machining	Excellent results in titanium machining thanks to a high hardness cutting-edge and the chip breaker reducing the cutting load
MF		Light machining	Chip breaker for low cutting resistance enables fine finishing.
MM		General machining	Optimal for general machining
None C/B		Super hard material machining	Optimal for high hardness die steel and heat resistant alloy

Recommended cutting condition

* Recommended chip breaker: ● First ○ Second

Workpiece	Hardness	Grades	Cutting conditions				Chip breaker						
			vc (m/min)	fz (mm/t)	ap (mm)	ae (mm)	MA	ML	MF	MM	None C/B 1 2		
P	Low carbon steel	HB80~180	PC5400	100~250	0.12~0.70	0.3~6.0	0.7D~0.1D	-	-	●	○	-	-
	High carbon steel	HB180~280	PC5400	100~220	0.12~0.70	0.3~6.0	0.7D~0.1D	-	-	●	○	-	-
	Low alloy steel	Under H _r C27	PC3700	180~290	0.20~0.60	0.3~6.0	0.7D~0.1D	-	-	-	●	○	-
			PC5400/PC5300	100~200	0.20~0.60	0.3~6.0	0.7D~0.1D	-	-	-	●	○	-
	Low pre-hardened steel	H _r C20~50	PC3700	130~250	0.30~0.50	~ 0.5	0.7D~0.1D	-	-	-	-	●	○
			PC2510/PC5300	50~150	0.30~0.50	~ 0.5	0.7D~0.1D	-	-	-	-	●	○
	High alloy steel	Under H _r C27	PC3700	130~250	0.30~0.50	~ 0.5	0.7D~0.1D	-	-	-	●	○	-
PC5300			100~220	0.30~0.50	~ 0.5	0.7D~0.1D	-	-	-	●	○	-	
High pre-hardened steel	H _r C20~48	PC2510/PC5300	50~150	0.30~0.50	~ 0.5	0.7D~0.1D	-	-	-	-	●	○	
M	Stainless steel	Under HB270	PC5300/PC5400	100~150	0.20~0.60	0.3~6.0	0.7D~0.1D	-	-	○	●	-	-
K	Gray cast iron, Ductile cast iron	Under 350MPa	PC5300	120~210	0.20~0.60	0.3~6.0	0.7D~0.1D	-	-	○	●	-	-
N	Aluminum	-	H01	300~800	0.30~0.60	0.3~6.0	0.7D~0.1D	●	-	-	-	-	-
S	Heat resistant alloy	Fe	H _r C20~30	PC5300/PC5400	35~60	0.30~0.50	~ 0.5	0.7D~0.1D	-	●	○	-	-
		Ni or Co	H _r C40~45	PC5300/PC5400	30~50	0.30~0.50	~ 0.5	0.7D~0.1D	-	●	○	-	-
	Titanium	H _r C35~45	PC5300/PC5400	40~70	0.30~0.50	~ 1.5	0.7D~0.1D	-	●	○	-	-	
H	High hardened materials	Over H _r C50	PC2505/PC2510	30~50	0.30~0.50	~ 0.5	0.7D~0.1D	-	-	-	-	●	○



➤ Feed per tooth according to ap (fz, mm/t)

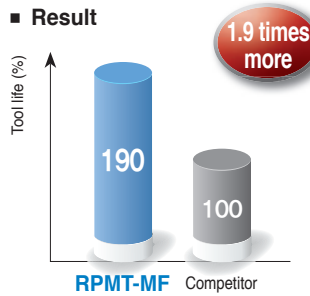
(mm)

Insert	Insert size (d)	Feed per tooth according to ap							
		ap = 1	ap = 2	ap = 3	ap = 4	ap = 5	ap = 6	ap = 8	ap = 10
RPMT08	8	0.30	0.22	0.18	0.15	-	-	-	-
RPMT10	10	0.40	0.28	0.25	0.20	0.12	-	-	-
RPMT12	12	0.60	0.45	0.35	0.30	0.25	0.20	-	-
RPMT16	16	0.65	0.45	0.40	0.32	0.30	0.28	0.23	-
RPMT20	20	0.70	0.50	0.42	0.35	0.32	0.29	0.25	0.22

➤ Performance evaluation

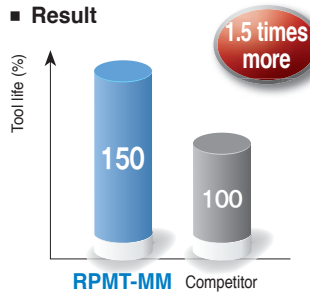
Alloy steel (SM490A Heat treatment, HRC 38~40)

- Cutting conditions**
 - vc (m/min) = 250
 - fz (mm/tooth) = 0.6
 - ap (mm) = 1
 - wet
- Tools**
 - Insert RPMT1204M0E-MF (PC5300)
 - Holder FMRS4032HRP-3L25



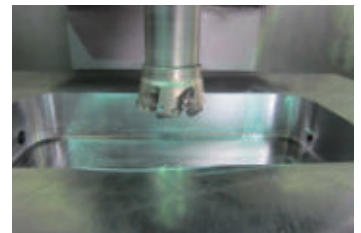
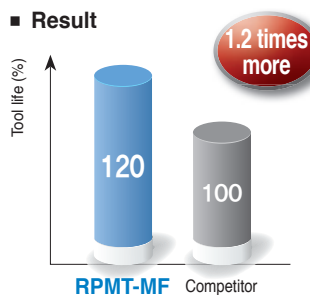
Low pre-hardened steel (KP4M Heat treatment, HRC 30~45)

- Cutting conditions**
 - vc (m/min) = 178
 - fz (mm/tooth) = 0.72
 - ap (mm) = 1.5
 - dry
- Tools**
 - Insert RPMT1606M0S-MM (PC5300)
 - Holder FMRCM5063HRP-4



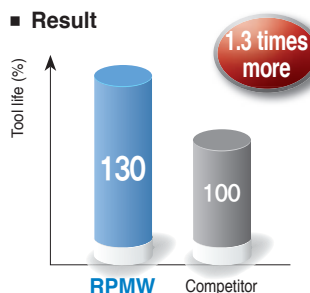
Low pre-hardened steel (KP1, HRC 28~33)

- Cutting conditions**
 - vc (m/min) = 178
 - fz (mm/tooth) = 0.74
 - ap (mm) = 0.8
 - dry
- Tools**
 - Insert RPMT1204M0E-MF (PC5300)
 - Holder FMRCM4063HRP-6



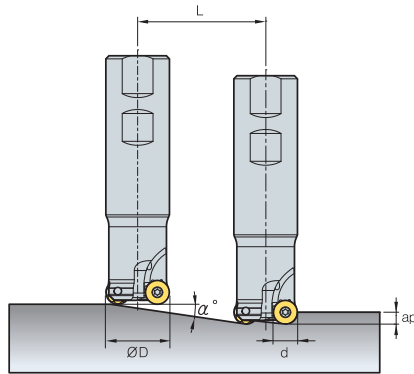
High pre-hardened steel (STD61, HRC 50~52)

- Cutting conditions**
 - vc (m/min) = 50
 - fz (mm/tooth) = 0.15
 - ap (mm) = 4.0
 - dry
- Tools**
 - Insert RPMW1204M0S1 (PC5300)
 - Holder FMRS4032HRP-3L25



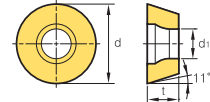
FMR P-positive

Maximum angle table for ramping machining



$$L_{min} = \frac{ap}{\tan \alpha^\circ} \text{ (mm)}$$

* L (mm): Cutting length
 α°: Max. ramping angle
 ap: Depth of cut



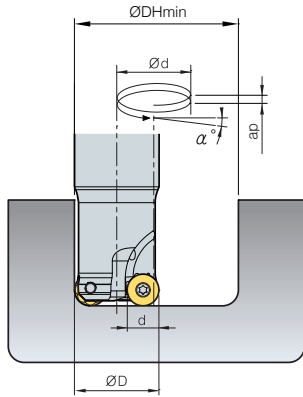
(mm)

Section	Insert size (d)	Tool dia. (ØD)	Ramping angle α° (max)	Cutting length L (mm) by ap									
				ap = 1	ap = 2	ap = 2.5	ap = 3	ap = 3.5	ap = 4	ap = 5	ap = 6	ap = 8	ap = 10
FMR2500	8	17	4.7	12	24	30	36	42	48	-	-	-	-
	8	18	4.1	14	28	34	41	48	55	-	-	-	-
	8	20	15.4	4	7	9	11	13	14	-	-	-	-
	8	21	13.9	4	8	10	12	14	16	-	-	-	-
	8	25	9.8	6	12	14	17	20	23	-	-	-	-
	8	26	9.2	6	12	16	19	22	25	-	-	-	-
FMR3000	10	25	13.8	4	8	10	12	14	16	20	-	-	-
	10	26	12.6	4	9	11	13	16	18	22	-	-	-
	10	32	8.4	7	14	17	20	24	27	34	-	-	-
	10	33	8.0	7	14	18	21	25	29	36	-	-	-
	10	40	5.8	10	20	25	30	34	39	49	-	-	-
	10	50	4.2	14	27	34	41	48	55	68	-	-	-
	10	63	3.1	19	37	47	56	65	75	93	-	-	-
	10	66	2.9	20	40	50	60	69	79	99	-	-	-
FMR4000	12	25	4.5	13	25	32	38	44	51	63	76	-	-
	12	26	4.1	14	28	35	42	49	56	70	84	-	-
	12	32	14.7	4	8	10	11	13	15	19	23	-	-
	12	33	13.8	4	8	10	12	14	16	20	24	-	-
	12	40	9.6	6	12	15	18	21	24	30	36	-	-
	12	50	6.7	9	17	21	26	30	34	43	51	-	-
	12	63	4.8	12	24	30	36	42	48	60	72	-	-
	12	66	4.5	13	26	32	38	45	51	64	77	-	-
	12	80	3.5	17	33	41	50	58	66	83	99	-	-
	12	100	2.6	22	44	55	65	76	87	109	131	-	-
FMR5000	16	40	17.8	3	6	8	9	11	12	16	19	25	-
	16	50	11.3	5	10	13	15	18	20	25	30	40	-
	16	63	7.6	7	15	19	22	26	30	37	45	60	-
	16	66	7.1	8	16	20	24	28	32	40	48	64	-
	16	80	5.3	11	21	27	32	37	43	53	64	85	-
	16	100	4.0	14	29	36	43	51	58	72	87	116	-
	16	125	3.0	19	38	48	58	67	77	96	115	154	-
	16	160	2.2	26	52	65	78	90	103	129	155	207	-
FMR6000	20	50	17.8	3	6	8	9	11	12	16	19	25	31
	20	63	11.1	5	10	13	15	18	20	25	30	41	51
	20	80	7.4	8	15	19	23	27	31	38	46	61	77
	20	100	5.3	11	21	27	32	37	43	53	64	85	107
	20	125	4.0	14	29	36	43	51	58	72	87	116	145
	20	160	2.9	20	40	49	59	69	79	99	119	158	198
	20	200	2.2	26	52	65	78	90	103	129	155	207	258
	20	250	1.7	33	67	84	100	117	134	167	200	267	334

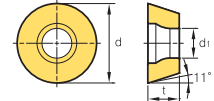
* Insert size (d): Please refer page E16 applicable insert drawing.

FMR P-positive

Minimum hole diameter table for helical machining (ØDHmin)



- $\varnothing D$ = Tool dia. (mm)
- $\varnothing d$ (Tool path, mm) = $\varnothing DH_{min}$, Max - $\varnothing D$
- $\varnothing DH_{min}$ (Minimum hole diameter) = $\varnothing D \times 2$ - Insert size (d)
- $\varnothing DH_{max}$ (Maximum hole diameter) = $\varnothing D \times 2$
- Ramping angle by ap (α°) = $\tan^{-1}\left(\frac{ap}{\pi \times \varnothing d}\right)$
- Helical angle adjusted by ap cannot exceed maximum angle
- ap = Depth of cut



(mm)

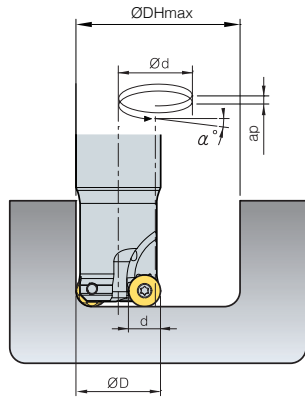
Section	Insert size (d)	Tool dia. (ØD)	Ramping angle α° (max)	ØDHmin	Ød	Ramping angle (α°) by ap									
						ap = 1	ap = 2	ap = 2.5	ap = 3	ap = 3.5	ap = 4	ap = 5	ap = 6	ap = 8	ap = 10
FMR2500	8	17	4.7	26	9	2.03	4.06	-	-	-	-	-	-	-	-
	8	18	4.1	28	10	1.83	3.65	-	-	-	-	-	-	-	-
	8	20	15.4	32	12	1.52	3.04	3.81	4.57	5.34	6.11	-	-	-	-
	8	21	13.9	34	13	1.40	2.81	3.51	4.22	4.92	5.63	-	-	-	-
	8	25	9.8	42	17	1.07	2.15	2.69	3.22	3.76	4.30	-	-	-	-
	8	26	9.2	44	18	1.01	2.03	2.54	3.04	3.55	4.06	-	-	-	-
FMR3000	10	25	13.8	40	15	1.22	2.43	3.04	3.65	4.27	4.88	-	-	-	-
	10	26	12.6	42	16	1.14	2.28	2.85	3.43	4.00	4.57	-	-	-	-
	10	32	8.4	54	22	0.83	1.66	2.07	2.49	2.91	3.32	-	-	-	-
	10	33	8.0	56	23	0.79	1.59	1.98	2.38	2.78	3.18	-	-	-	-
	10	40	5.8	70	30	0.61	1.22	1.52	1.83	2.13	2.43	-	-	-	-
	10	50	4.2	90	40	0.46	0.91	1.14	1.37	1.60	1.83	-	-	-	-
	10	63	3.1	116	53	0.34	0.69	0.86	1.03	1.21	1.38	-	-	-	-
	10	66	2.9	122	56	0.33	0.65	0.81	0.98	1.14	1.30	-	-	-	-
FMR4000	12	25	4.5	38	13	1.40	2.81	3.51	-	-	-	-	-	-	-
	12	26	4.1	40	14	1.30	2.61	3.26	-	-	-	-	-	-	-
	12	32	14.7	52	20	0.91	1.83	2.28	2.74	3.20	3.65	4.57	5.49	-	-
	12	33	13.8	54	21	0.87	1.74	2.17	2.61	3.04	3.48	4.35	5.23	-	-
	12	40	9.6	68	28	0.65	1.30	1.63	1.96	2.28	2.61	3.26	3.92	-	-
	12	50	6.7	88	38	0.48	0.96	1.20	1.44	1.68	1.92	2.40	2.88	-	-
	12	63	4.8	114	51	0.36	0.72	0.89	1.07	1.25	1.43	1.79	2.15	-	-
	12	66	4.5	120	54	0.34	0.68	0.84	1.01	1.18	1.35	1.69	2.03	-	-
	12	80	3.5	148	68	0.27	0.54	0.67	0.81	0.94	1.07	1.34	1.61	-	-
	12	100	2.6	188	88	0.21	0.41	0.52	0.62	0.73	0.83	1.04	1.24	-	-
FMR5000	16	40	17.8	64	24	0.76	1.52	1.90	2.28	2.66	3.04	3.81	4.57	6.11	-
	16	50	11.3	84	34	0.54	1.07	1.34	1.61	1.88	2.15	2.69	3.22	4.30	-
	16	63	7.6	110	47	0.39	0.78	0.97	1.16	1.36	1.55	1.94	2.33	3.11	-
	16	66	7.1	116	50	0.36	0.73	0.91	1.09	1.28	1.46	1.83	2.19	2.92	-
	16	80	5.3	144	64	0.29	0.57	0.71	0.86	1.00	1.14	1.43	1.71	2.28	-
	16	100	4.0	184	84	0.22	0.43	0.54	0.65	0.76	0.87	1.09	1.30	1.74	-
	16	125	3.0	234	109	0.17	0.33	0.42	0.50	0.59	0.67	0.84	1.00	1.34	-
	16	160	2.2	304	144	0.13	0.25	0.32	0.38	0.44	0.51	0.63	0.76	1.01	-
FMR6000	20	50	17.8	80	30	0.61	1.22	1.52	1.83	2.13	2.43	3.04	3.65	4.88	6.11
	20	63	11.1	106	43	0.42	0.85	1.06	1.27	1.49	1.70	2.12	2.55	3.40	4.25
	20	80	7.4	140	60	0.30	0.61	0.76	0.91	1.06	1.22	1.52	1.83	2.43	3.04
	20	100	5.3	180	80	0.23	0.46	0.57	0.68	0.80	0.91	1.14	1.37	1.83	2.28
	20	125	4.0	230	105	0.17	0.35	0.43	0.52	0.61	0.70	0.87	1.04	1.39	1.74
	20	160	2.9	300	140	0.13	0.26	0.33	0.39	0.46	0.52	0.65	0.78	1.04	1.30
	20	200	2.2	380	180	0.10	0.20	0.25	0.30	0.35	0.41	0.51	0.61	0.81	1.01
	20	250	1.7	480	230	0.08	0.16	0.20	0.24	0.28	0.32	0.40	0.48	0.63	0.79

* Insert size (d): Please refer page E16 applicable insert drawing.

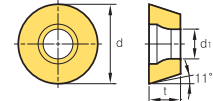


FMR P-positive

Maximum hole diameter table for helical machining (ØDHmax)



- ØD = Tool dia. (mm)
- Ød (Tool path, mm) = ØDHmin, Max - ØD
- ØDHmin (Minimum hole diameter) = ØD × 2 - Insert size (d)
- ØDHmax (Maximum hole diameter) = ØD × 2 - 2
- Ramping angle by ap (α°) = $\tan^{-1} \left(\frac{ap}{\pi \times \text{Ød}} \right)$
- Helical angle adjusted by ap cannot exceed maximum angle
- ap = Depth of cut



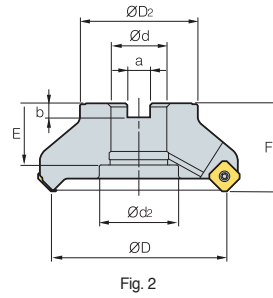
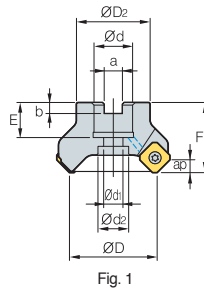
(mm)

Section	Insert size (d)	Tool dia. (ØD)	Ramping angle α° (max)	ØDHmax	Ød	Ramping angle (α°) by ap									
						ap = 1	ap = 2	ap = 2.5	ap = 3	ap = 3.5	ap = 4	ap = 5	ap = 6	ap = 8	ap = 10
FMR2500	8	17	4.7	32	15	1.22	2.43	3.04	3.65	-	-	-	-	-	-
	8	18	4.1	34	16	1.14	2.28	2.85	3.43	-	-	-	-	-	-
	8	20	15.4	38	18	1.01	2.03	2.54	3.04	3.55	4.06	-	-	-	-
	8	21	13.9	40	19	0.96	1.92	2.40	2.88	3.37	3.85	-	-	-	-
	8	25	9.8	48	23	0.79	1.59	1.98	2.38	2.78	3.18	-	-	-	-
	8	26	9.2	50	24	0.76	1.52	1.90	2.28	2.66	3.04	-	-	-	-
FMR3000	10	25	13.8	48	23	0.79	1.59	1.98	2.38	2.78	3.18	-	-	-	-
	10	26	12.6	50	24	0.76	1.52	1.90	2.28	2.66	3.04	-	-	-	-
	10	32	8.4	62	30	0.61	1.22	1.52	1.83	2.13	2.43	-	-	-	-
	10	33	8.0	64	31	0.59	1.18	1.47	1.77	2.06	2.36	-	-	-	-
	10	40	5.8	78	38	0.48	0.96	1.20	1.44	1.68	1.92	-	-	-	-
	10	50	4.2	98	48	0.38	0.76	0.95	1.14	1.33	1.52	-	-	-	-
	10	63	3.1	124	61	0.30	0.60	0.75	0.90	1.05	1.20	-	-	-	-
FMR4000	12	25	4.5	48	23	0.79	1.59	1.98	2.38	2.78	3.18	-	-	-	-
	12	26	4.1	50	24	0.76	1.52	1.90	2.28	2.66	3.04	-	-	-	-
	12	32	14.7	62	30	0.61	1.22	1.52	1.83	2.13	2.43	3.04	3.65	-	-
	12	33	13.8	64	31	0.59	1.18	1.47	1.77	2.06	2.36	2.95	3.54	-	-
	12	40	9.6	78	38	0.48	0.96	1.20	1.44	1.68	1.92	2.40	2.88	-	-
	12	50	6.7	98	48	0.38	0.76	0.95	1.14	1.33	1.52	1.90	2.28	-	-
	12	63	4.8	124	61	0.30	0.60	0.75	0.90	1.05	1.20	1.50	1.80	-	-
	12	66	4.5	130	64	0.29	0.57	0.71	0.86	1.00	1.14	1.43	1.71	-	-
	12	80	3.5	158	78	0.23	0.47	0.58	0.70	0.82	0.94	1.17	1.40	-	-
FMR5000	16	40	17.8	78	38	0.48	0.96	1.20	1.44	1.68	1.92	2.40	2.88	3.85	-
	16	50	11.3	98	48	0.38	0.76	0.95	1.14	1.33	1.52	1.90	2.28	3.04	-
	16	63	7.6	124	61	0.30	0.60	0.75	0.90	1.05	1.20	1.50	1.80	2.39	-
	16	66	7.1	130	64	0.29	0.57	0.71	0.86	1.00	1.14	1.43	1.71	2.28	-
	16	80	5.3	158	78	0.23	0.47	0.58	0.70	0.82	0.94	1.17	1.40	1.87	-
	16	100	4.0	198	98	0.19	0.37	0.47	0.56	0.65	0.74	0.93	1.12	1.49	-
	16	125	3.0	248	123	0.15	0.30	0.37	0.45	0.52	0.59	0.74	0.89	1.19	-
	16	160	2.2	318	158	0.12	0.23	0.29	0.35	0.40	0.46	0.58	0.69	0.92	-
FMR6000	20	50	17.8	98	48	0.38	0.76	0.95	1.14	1.33	1.52	1.90	2.28	3.04	3.81
	20	63	11.1	124	61	0.30	0.60	0.75	0.90	1.05	1.20	1.50	1.80	2.39	2.99
	20	80	7.4	158	78	0.23	0.47	0.58	0.70	0.82	0.94	1.17	1.40	1.87	2.34
	20	100	5.3	198	98	0.19	0.37	0.47	0.56	0.65	0.74	0.93	1.12	1.49	1.86
	20	125	4.0	248	123	0.15	0.30	0.37	0.45	0.52	0.59	0.74	0.89	1.19	1.48
	20	160	2.9	318	158	0.12	0.23	0.29	0.35	0.40	0.46	0.58	0.69	0.92	1.16
	20	200	2.2	398	198	0.09	0.18	0.23	0.28	0.32	0.37	0.46	0.55	0.74	0.92
20	250	1.7	498	248	0.07	0.15	0.18	0.22	0.26	0.29	0.37	0.44	0.59	0.74	

* Insert size (d): Please refer page E16 applicable insert drawing.



FMAC(M)3000



Designation			ØD	ØD ₂	Ød	a	b	E	F	Ød ₁	Ød ₂	ap		Fig.
FMACM	3050HR	4	50	42	22	10.4	6.3	20	40	11	17.5	4.0	0.4	1
	3050HR-H	6	50	42	22	10.4	6.3	20	40	11	17.5	4.0	0.4	1
	3063HR	5	63	49	22	10.4	6.3	20	40	11	17.5	4.0	0.5	1
	3063HR-H	8	63	49	22	10.4	6.3	20	40	11	17.5	4.0	0.6	1
FMAC (FMACM)	3080HR	6	80	57	25.4 (27)	9.5 (12.4)	6 (7)	25 (23)	50	14	20	4.0	1.1	1
	3080HR-H	10	80	57	25.4 (27)	9.5 (12.4)	6 (7)	25 (23)	50	14	20	4.0	1.2	1
	3100HR	7	100	67	31.75 (32)	12.7 (14.4)	8 (8)	35 (25.5)	50	(18)	45 (26)	4.0	1.7	2 (1)
	3100HR-H	12	100	67	31.75 (32)	12.7 (14.4)	8 (8)	35 (25.5)	50	(18)	45 (26)	4.0	1.7	2 (1)
	3125HR	8	125	87	38.1 (40)	15.9 (16.4)	10 (9)	42 (29)	63	(22)	55 (32)	4.0	3.3 (3.5)	2 (1)
	3125HR-H	14	125	87	38.1 (40)	15.9 (16.4)	10 (9)	42 (29)	63	(22)	55 (32)	4.0	3.3 (3.5)	2 (1)

(mm)

Available inserts

() Metric size



Designation	Cermet		Coated												Uncoated				page	
	CN2500	CN30	NC5330	NCM325	NCM335	NCM335	NCM545	PC2505	PC2010	PC3700	PC6510	PC9530	PC9540	PC5300	PC5400	ST30A	G10	H01		H05
SEET	0903AGFN-MA																			
	0903AGSN-MF										●	●		●	●			●	●	
	0903AGSN-MM				●						●	●		●	●					
SEXT	0903AGSN-MF										●	●		●	●					
	0903AGSN-MM									●	●			●	●					
	0903AGSN-MR																			
SEEW	0903AGTN																			

Available arbors

Designation	Ød	NC arbors
FMACM	3050HR-□	BT□□-FMC22-□□
	3063HR-□	
FMAC (FMACM)	3080HR-□	BT□□-FMA25.4-□□
		BT□□-FMC27-□□
	3100HR-□	BT□□-FMA31.75-□□
		BT□□-FMC32-□□
	3125HR-□	BT□□-FMA38.1-□□
	40	BT□□-FMB/FMC40-□□

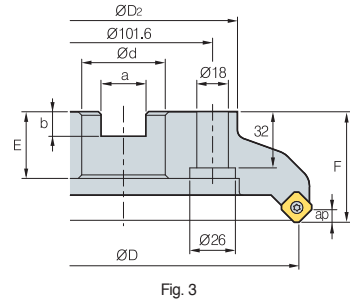
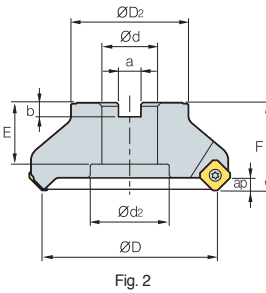
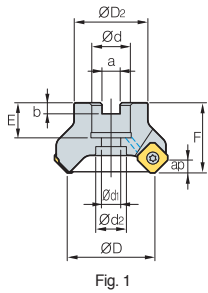
Parts

Specification		
Ø50~Ø125	FTKA0307	TW09S

Available inserts E21, E22 Available arbors and bolt E426~E428



FMAC(M)4000



AA
45°

• AR: 21°
• RR: -17°~-12°

Designation		⊙	ØD	ØD ₂	Ød	a	b	E	F	Ød ₁	Ød ₂	ap	kg	Fig.
FMACM	4050HR	3	50	42	22	10.4	6.3	20	40	11	18	6.5	0.4	1
	4063HR	4	63	49	22	10.4	6.3	20	40	11	18	6.5	0.6	1
	4063HR-M	5	63	49	22	10.4	6.3	20	40	11	18	6.5	0.6	1
	4063HR-H	6	63	49	22	10.4	6.3	20	40	11	18	6.5	0.6	1
FMAC (FMACM)	4080HR	5	80	57	25.4 (27)	9.5 (12.4)	6 (7)	25 (23)	50	14	20	6.5	1.1	1
	4080HR-M	6	80	57	25.4 (27)	9.5 (12.4)	6 (7)	25 (23)	50	14	20	6.5	1.1	1
	4080HR-H	8	80	57	25.4 (27)	9.5 (12.4)	6 (7)	25 (23)	50	14	20	6.5	1.1	1
	4100HR	5	100	67	31.75 (32)	12.7 (14.4)	8 (8)	33 (25)	63 (50)	18	26	6.5	2 (1.6)	1
	4100HR-M	7	100	67	31.75 (32)	12.7 (14.4)	8 (8)	33 (25)	63 (50)	18	26	6.5	2 (1.6)	1
	4100HR-H	10	100	67	31.75 (32)	12.7 (14.4)	8 (8)	33 (25)	63 (50)	18	26	6.5	2 (1.6)	1
	4125HR	6	125	87	38.1 (40)	15.9 (16.4)	10 (9)	35 (29)	63	22	32	6.5	3.1	1
	4125HR-M	8	125	87	38.1 (40)	15.9 (16.4)	10 (9)	35 (29)	63	22	32	6.5	3.1	1
	4125HR-H	12	125	87	38.1 (40)	15.9 (16.4)	10 (9)	35 (29)	63	22	32	6.5	3.1	1
	4160R	7	160	107	50.8 (40)	19.0 (16.4)	11 (9)	38 (35)	63	-	-	6.5	4.8	2
	4160R-M	10	160	107	50.8 (40)	19.0 (16.4)	11 (9)	38 (35)	63	-	-	6.5	4.8	2
	4160R-H	16	160	107	50.8 (40)	19.0 (16.4)	11 (9)	38 (35)	63	-	-	6.5	4.8	2
	4200R	8	200	130	47.625 (60)	25.4 (25.7)	14	38 (32)	63	-	-	6.5	6.1	3
	4200R-M	12	200	130	47.625 (60)	25.4 (25.7)	14	38 (32)	63	-	-	6.5	6.1	3
4200R-H	18	200	130	47.625 (60)	25.4 (25.7)	14	38 (32)	63	-	-	6.5	6.1	3	

Available inserts

() Metric size

SEET-MF	SEET-MM	SEET-MA	SEXT-MF	SEXT-MM	SEXT-MR	SEEW	SEEW-W												
Designation	Cermet	Coated						Uncoated	page	Designation	Cermet	Coated						Uncoated	page
	CN2500 CN30	NC5330 NCM325	NCM335 NCM535	NCM545 PC3700	PC6510 PC9540	PC5300 PC5400	PD2000 PD1010	H01 H05			CN2500 CN30	NC5330 NCM325	NCM335 NCM535	NCM545 PC2505	PC2010 PC3700	PC6510 PC9540	PC5300 PC5400	H01 H05	
SEET 14M4AGFN-MA									E21	SEXT 14M4AGSN-MR									E21
14M4AGSN-MF		●		●●	●●				E22	SEEW 14M4AGTN	●								E22
14M4AGSN-MM		●		●●	●●					14M4AGFN-W									
SEXT 14M4AGSN-MF				●	●●					14M4AGSN-W							●		
14M4AGSN-MM		●		●●	●●					14M4AGTN-W					●				

Available arbors

Designation	Ød	NC arbors	Designation	Ød	NC arbors
FMACM 4050HR-□	22	BT□□-FMC22-□□	FMAC (FMACM) 4125HR-□	38.1	BT□□-FMA38.1-□□
4063HR-□		BT□□-FMA25.4-□□		40	BT□□-FMB40-□□
FMAC (FMACM) 4080HR-□	25.4	BT□□-FMC27-□□	4160R-□	50.8	BT□□-FMA50.8-□□
4100HR-□	27	BT□□-FMA31.75-□□		40	BT□□-FMB/FMC40-□□
	31.75	BT□□-FMC32-□□	4200R-□	47.625	BT□□-FMA47.625-□□
	32			60	BT□□-FMB60-□□

Parts

Specification					
Ø50-Ø200	FTGA03512	SS42SAF	SHXN0509F	TW15S	HW35L

Available inserts E21, E22

Available arbors and bolt E426~E428

FMAC(M)3000-A

Aluminum body

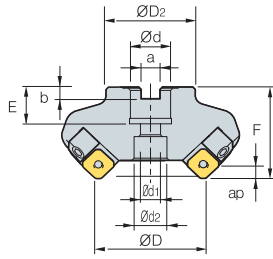


Fig. 1

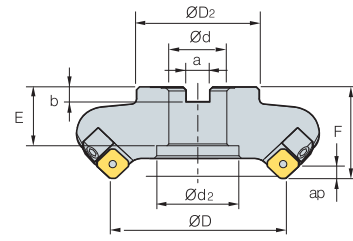


Fig. 2



AA
45°
• AR: 21°
• RR: -16°~-12°

(mm)

Designation		ØD	ØD ₂	Ød	a	b	E	F	Ød ₁	Ød ₂	ap		Fig.
FMACM 3063R-A	3	63	49	22	10.4	6.3	20	40	11	18	4	0.5	1
FMAC 3080R-A	4	80	57	25.4 (27)	9.5 (12.4)	6 (7)	25	50	13.5	20	4	0.6	1
(FMACM) 3100R-A	5	100	67	31.75 (32)	12.7 (14.4)	8 (8)	32	50	-	45	4	0.8	2
3100R-25.4-A	5	100	67	25.4	9.5	6	25	50	-	38	4	0.9	2
3125R-A	6	125	87	38.1 (40)	15.9 (16.4)	10 (9)	38	63	-	56	4	1.6	2
3125R-25.4-A	6	125	70	25.4	9.5	6	25	63	-	38	4	1.7	2

() Metric size

Available inserts



Designation	Cermet		Coated												Uncoated				page	
	CN2500	CN30	NC5330	NCM325	NCM335	NCM535	NCM545	PC2505	PC2010	PC3700	PC6510	PC9530	PC9540	PC5300	PC5400	ST30A	G10	H01		H05
SEET 0903AGFN-MA																				
SEET 0903AGSN-MF											●	●								
SEET 0903AGSN-MM				●										●	●					
SEXT 0903AGSN-MF											●			●	●					
SEXT 0903AGSN-MM										●	●			●	●					
SEXT 0903AGSN-MR														●	●					
SEEW 0903AGTN																				

Available arbors

Designation	Ød	NC arbors
FMACM 3063R-□	22	BT□□-FMC22-□□
FMAC 3080R-□	25.4	BT□□-FMA25.4-□□
	27	BT□□-FMC27-□□
3100R-□	31.75	BT□□-FMA31.75-□□
	32	BT□□-FMC32-□□
3125R-□	38.1	BT□□-FMA38.1-□□
	40	BT□□-FMB40-□□

Parts

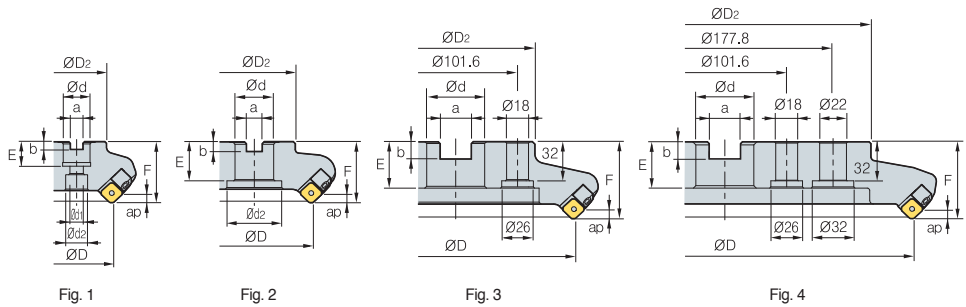
Specification					
Ø63~Ø125	FTKA0307	TW09S	HW30L	LFMA3R-A	DHA0620

Available inserts E21, E22 Available arbors and bolt E426-E428



FMAC(M)4000-A

Aluminum body



Designation		ØD	ØD2	Ød	a	b	E	F	Ød1	Ød2	ap		Fig.
FMACM 4063R-A	3	63	49	22	10.4	6.3	20	50	11	18	6.5	0.6	1
FMAC 4080R-A	4	80	67	25.4 (27)	9.5 (12.4)	6 (7)	25 (22)	50	13.5	20	6.5	0.8	1
(FMACM) 4100R-A	5	100	67	31.75 (32)	12.7 (14.4)	8 (8)	32	50	-	45	6.5	1.1	2
4100R-25.4-A	5	100	67	25.4	9.5	6	25	50	-	38	6.5	1.2	2
4125R-A	6	125	87	38.1 (40)	15.9 (16.4)	10 (9)	38 (35)	63	-	56	6.5	1.7	2
4125R-25.4-A	6	125	70	25.4	9.5	6	25	63	-	38	6.5	1.8	2
4160R-A	7	160	107	50.8 (40)	19.0 (16.4)	11 (9)	38 (35)	63	-	75	6.5	2.5	2
4200R-A	8	200	130	47.625 (60)	25.4 (25.7)	14 (14)	38 (32)	63	-	-	6.5	3.2	3
4250R-A	10	250	180	47.625 (60)	25.4 (25.7)	14 (14)	38	63	-	-	6.5	4.1	3
4315R-A	12	315	240	47.625 (60)	25.4 (25.7)	14 (14)	38	63	-	-	6.5	6.7	4

Note) Through coolant type between Ø50~Ø125 () Metric size

Available inserts

		SEET-MF	SEET-MM	SEET-MA	SEXT-MF	SEXT-MM	SEXT-MR	SEEW	SEEW-W										
Designation	Cement										Coated					page			
	CN2500	CN30	NC5330	NCM325	NCM335	NCM335	NCM335	NCM545	PC3700	PC8510	PC9530	PC9540	PC5300	PC5400	PD2000		PD1010	H01	H05
SEET 14M4AGFN-MA																			
14M4AGSN-MF																			
14M4AGSN-MM																			
SEXT 14M4AGSN-MF																			
14M4AGSN-MM																			
Designation	Cement										Coated					page			
	CN2500	CN30	NC5330	NCM325	NCM335	NCM335	NCM335	NCM545	PC2505	PC2010	PC3700	PC6510	PC9530	PC9540	PC5300		PC5400	H01	H05
SEXT 14M4AGSN-MR																			
SEEW 14M4AGTN																			
14M4AGFN-W																			
14M4AGSN-W																			
14M4AGTN-W																			

Available arbors

Designation	Ød	NC arbors
FMACM 4063R-□	22	BT□□-FMC22-□□
FMAC (FMACM) 4080R-□	25.4	BT□□-FMA25.4-□□
	27	BT□□-FMC27-□□
4100HR-□	31.75	BT□□-FMA31.75-□□
4125R-□	32	BT□□-FMC32-□□
	38.1	BT□□-FMA38.1-□□

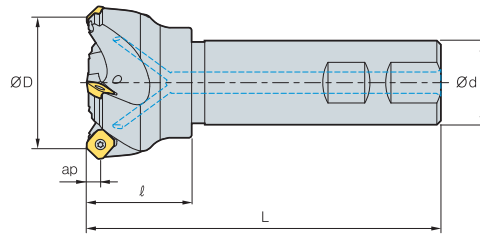
Designation	Ød	NC arbors
FMAC (FMACM) 4125R-□	40	BT□□-FMB40-□□
4160R-□	50.8	BT□□-FMA50.8-□□
	40	BT□□-FMB/FMC40-□□
4200R-□	47.625	BT□□-FMA47.625-□□
4250R-□	60	BT□□-FMB60-□□
4315R-□	60	BT□□-FMB60-□□

Parts

Specification					
Ø63~Ø315	FTGA03510	TW15S	HW40L	LFMA4R-A	DHA0830

Available inserts E21, E22 Available arbors and bolt E426~E428

FMAS3000



AA
45°

• AR: 23°
• RR: -17°~13°

(mm)

Designation		ØD	Ød	ℓ	L	ap	
FMAS							
3025HR	2	25	25	35	115	4	0.4
3032HR	3	32	25	40	125	4	0.5
3032HR-S32	3	32	32	40	130	4	0.8
3040HR	3	40	32	40	130	4	0.9
3040HR-S40	3	40	40	40	140	4	1.3
3040HR-S42	3	40	42	40	140	4	1.4
3050HR	4	50	32	40	135	4	1
3050HR-S40	4	50	40	40	140	4	1.3
3050HR-S42	4	50	42	40	140	4	1.5
3063HR	5	63	32	45	135	4	1.2
3063HR-S40	5	63	40	45	145	4	1.6
3063HR-S42	5	63	42	45	145	4	1.7

Available inserts



Designation	Cermet		Coated										Uncoated				page			
	CN2500	CN30	NC5330	NCM325	NCM335	NCM535	NCM545	PC2505	PC2010	PC3700	PC6510	PC9530	PC9540	PC5300	PC5400	ST30A		G10	H01	H05
SEET																				
0903AGFN-MA																				
0903AGSN-MF											●	●		●	●			●	●	
0903AGSN-MM				●							●			●	●					
SEXT																				
0903AGSN-MF											●			●	●					
0903AGSN-MM									●	●				●	●					
0903AGSN-MR																				
SEEW																				
0903AGTN																				

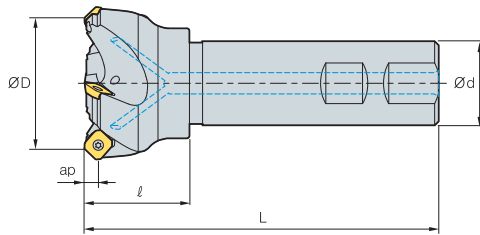
Parts

Specification		
Ø25~Ø63	FTKA0307	TW09S

Available inserts E21, E22



FMAS4000



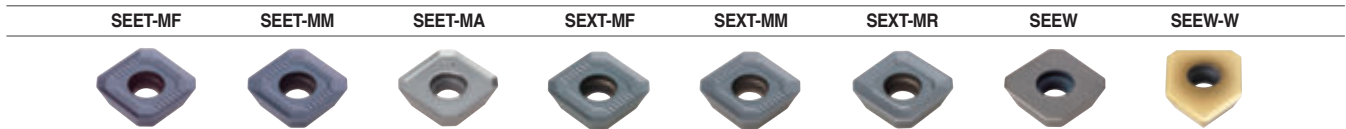
AA
45°

• AR: 23°
• RR: -17°~-13°

(mm)

Designation		ØD	Ød	l	L	ap	
FMAS	4050HR	3	50	32	45	135	1
	4050HR-S40	3	50	40	45	135	1.3
	4050HR-S42	3	50	42	45	135	1.45
	4063HR	4	63	32	45	135	1.2
	4063HR-S40	4	63	40	45	135	1.5
	4063HR-S42	4	63	42	45	135	1.6

Available inserts



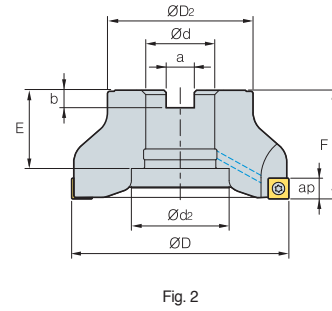
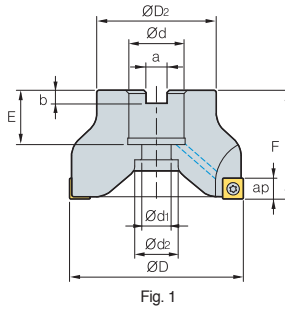
Designation	Cermet		Coated										Uncoated			page				
	CN2500	CN80	NC5330	NCM325	NCM335	NCM535	NCM545	PC2505	PC3700	PC6510	PC9530	PC9540	PC5300	PC5400	PD2000		PD1010	ST30A	H01	H05
SEET	14M4AGFN-MA														●	●		●	●	E21 E22
	14M4AGSN-MF					●				●	●		●	●						
	14M4AGSN-MM					●			●	●	●		●	●						
SEXT	14M4AGSN-MF									●			●	●						
	14M4AGSN-MM				●				●	●	●		●	●						
	14M4AGSN-MR										●		●							
SEEW	14M4AGTN		●																	
	14M4AGFN-W																			
	14M4AGSN-W												●							
	14M4AGTN-W									●										

Parts

Specification					
Ø50~Ø63	FTGA03512	SS42SAF	SHXN0509F	TW15S	HW35L

Available inserts E21, E22

FMPC(M)3000



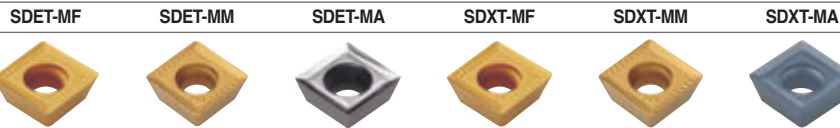
• AR: 10°
• RR: -9°~8°

(mm)

Designation		$\varnothing D$	$\varnothing D_2$	$\varnothing d$	a	b	E	F	$\varnothing d_1$	$\varnothing d_2$	ap		Fig.	
FMPCM	3050HS	5	50	40	22	10.4	6.3	20	40	11	18	7	0.3	1
	3063HS	6	63	40	22	10.4	6.3	20	40	11	18	7	0.5	1
FMPC (FMPCM)	3080HS	7	80	55	25.4 (27)	9.5 (12.4)	6 (7)	25 (22)	50	14	20	7	1.0	1
	3100HS	8	100	67	31.75 (32)	12.7 (14.4)	8 (8)	36 (26)	50	18	45 (26)	7	1.5	2 (1)

() Metric size

Available inserts



Designation	Cermet		Coated											Uncoated				page							
	CN2500	CN30	NC5330	NCM325	NCM335	NCM535	NCM545	PC2010	PC3700	PC6510	PC9530	PC9540	PC5300	PC5400	PD2000	ST30A	G10		H01	H05					
SDET	09M402R-MA																								
	09M405R-MF																								
	09M405R-MM																								
SDXT	09M405R-MF																								
	09M405L-MF																								
	09M405R-MM																								
	09M405L-MM																								
	09M405R-MA																								

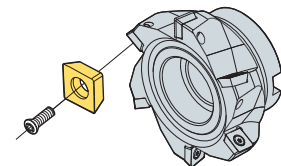
Available arbors

Designation	$\varnothing d$	NC arbors
FMPCM	3050HS	BT□□-FMC22-□□
	3063HS	
FMPC (FMPCM)	3080HS	BT□□-FMA25.4-□□
		BT□□-FMC27-□□
	3100HS	BT□□-FMA31.75-□□
		BT□□-FMC32-□□

Parts

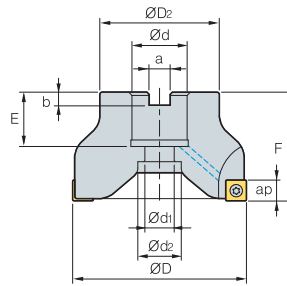
Specification		
$\varnothing 50 \sim \varnothing 100$	Screw FTGA03508	Wrench TW15S

Assembling



Available inserts E19, E20 Available arbors and bolt E426~E428

FMPC(M)4000



Designation		⊗	ØD	ØD ₂	Ød	a	b	E	F	Ød ₁	Ød ₂	ap	kg
FMPCM	4063HS	5	63	49	22	10.4	6.3	20 (20)	50 (50)	11	18	11	0.4
FMPC	4080HS	6	80	57	25.4 (27)	9.5 (12.4)	6 (7)	25 (23)	50 (50)	14	20	11	0.9
(FMPCM)	4100HS	7	100	67	31.75 (32)	12.7 (14.4)	8 (8)	33 (25)	63 (50)	18	26	11	1.9 (1.5)
	4125HS	8	125	87	38.1 (40)	15.9 (16.4)	10 (9)	35 (29)	63	22	32	11	3.1

(mm)

()Metric size

Available inserts

		SDET-MF	SDET-MM	SDET-MA	SDXT-MF	SDXT-MM	SDXT-MA																
Designation		Cermet		Coated								Uncoated				page							
		CN2500	CN30	NC5330	NCM325	NCM335	NCM535	NCM545	PC2010	PC3700	PC6510	PC9530	PC9540	PC5300	PC5400		PD1010	ST30A	G10	H01	H05		
SDET	130504R-MA																						
	130508R-MF																						
	130508R-MM																						
SDXT	130508R-MF																						
	130508R-MM																						
	130508R-MA																						

E19

E20

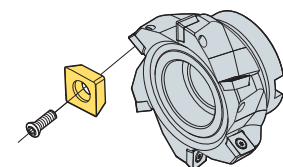
Available arbors

Designation	Ød	NC arbors
FMPCM 4063HS	22	BT□□-FMC22-□□
FMPC 4080HS	25.4	BT□□-FMA25.4-□□
(FMPCM) 4100HS	27	BT□□-FMC27-□□
	31.75	BT□□-FMA31.75-□□
	32	BT□□-FMC32-□□
	38.1	BT□□-FMA38.1-□□
4125HS	40	BT□□-FMB/FMC40-□□

Parts

Specification		
Ø63-Ø125	FTNC04511	TW20S

Assembling



Available inserts E19,E20 Available arbors and bolt E426~E428

FMPC(M)3000-A

Aluminum body

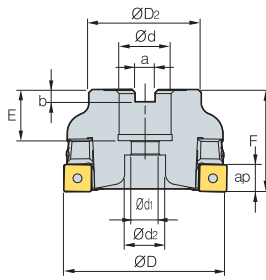
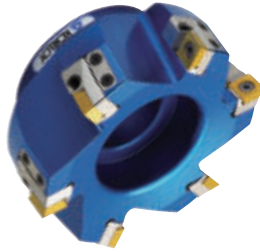


Fig. 1

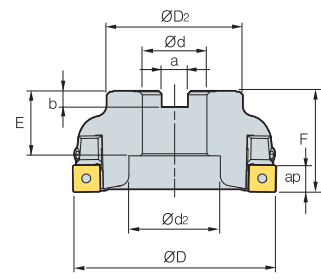


Fig. 2



AA
90°

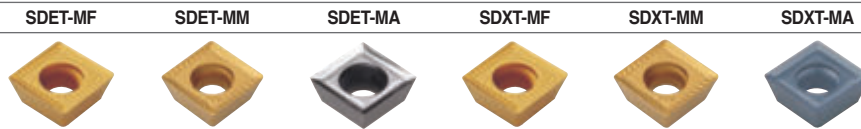
• AR: 10°
• RR: -9°~-7.3°

(mm)

Designation	ØD	ØD ₂	Ød	a	b	E	F	Ød ₁	Ød ₂	ap	kg	Fig.
FMPCM 3063S-A	63	40	22	10.4	6.3	20	40	11.0	18	7	0.2	1
FMPC 3080S-A	80	55	25.4 (27)	9.5 (12.4)	6 (7)	25 (22)	50	13.5	20	7	0.4	1
(FMPCM) 3100S-A	100	67	31.75 (32)	12.7 (14.4)	8 (8)	32	50	-	45	7	0.6	2
3100S-25.4-A	100	67	25.4	9.5	6	25	50	-	38	7	0.7	2

()Metric size

Available inserts



Designation	Cermet		Coated										Uncoated				page		
	CN2500	CN30	NC5330	NCM325	NCM335	NCM335	NCM545	PC2010	PC3700	PC6510	PC9530	PC9540	PC5300	PC5400	PD2000	ST30A		G10	H01
SDET 09M402R-MA															●			●	●
09M405R-MF																			
09M405R-MM																			
SDXT 09M405R-MF				●				●	●	●			●	●					
09M405L-MF																			
09M405R-MM				●	●			●	●	●			●	●					
09M405L-MM																			
09M405R-MA																		●	●

Available arbors

Designation	Ød	NC arbors
FMPCM 3063S-□	22	BT□□-FMC22-□□
FMPC 3080S-□	25.4	BT□□-FMA25.4-□□
	27	BT□□-FMC27-□□
3100S-□	31.75	BT□□-FMA31.75-□□
	32	BT□□-FMC32-□□
3100S-25.4-□	25.4	BT□□-FMA25.4-□□

Parts

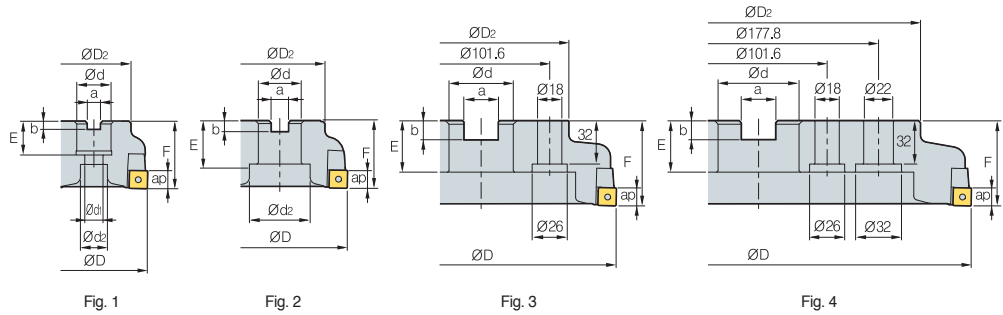
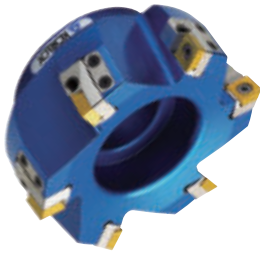
Specification	Screw	Insert wrench	Locator wrench	Locator	Locator screw	Chip cover	Chip cover screw
Ø63	FTGA03508	TW15S	HW30L	LFMP3R-A	DHA0624	CFMP3R14R1-A	PXMA0306
Ø80~Ø100	FTGA03508	TW15S	HW30L	LFMP3R-A	DHA0624	CFMP3R-A	PXMA0306

Available inserts E19, E20 Available arbors and bolt E426~E428



FMPC(M)4000-A

Aluminum body



AA
90°

• AR: 10°
• RR: -9°~7.3°

(mm)

Designation		ØD	ØD ₂	Ød	a	b	E	F	Ød ₁	Ød ₂	ap		Fig.
FMPCM 4063S-A	3	63	49	22	10.4	6.3	20	50	11	18	11	0.6	1
FMPC 4080S-A	4	80	67	25.4 (27)	9.5 (12.4)	6 (7)	25 (22)	50	13.5	20	11	0.8	1
(FMPCM) 4100S-A	5	100	67	31.75 (32)	12.7 (14.4)	8(8)	32	50	-	45	11	1.1	2
4100S-25.4-A	5	100	67	25.4	9.5	6	25	50	-	38	11	1.2	2
4125S-A	6	125	87	38.1 (40)	15.9 (16.4)	10 (9)	38 (35)	63	-	56	11	1.7	2
4125S-25.4-A	6	125	70	25.4	9.5	6	25	63	-	38	11	1.8	2
4160S-A	8	160	107	50.8 (40)	19.0 (16.4)	11 (9)	38 (35)	63	-	75	11	2.5	2
4200S-A	10	200	130	47.625 (60)	25.4 (25.7)	14 (14)	38 (32)	63	-	-	11	3.2	3
4250S-A	12	250	180	47.625 (60)	25.4 (25.7)	14 (14)	38	63	-	-	11	4.1	3
4315S-A	15	315	240	47.625 (60)	25.4 (25.7)	14 (14)	38	63	-	-	11	6.7	4

() Metric size

Available inserts

		SDET-MF	SDET-MM	SDET-MA	SDXT-MF	SDXT-MM	SDXT-MA																		
Designation		Cermet		Coated								Uncoated		page											
		CN2500	CN30	NC5330	NCM325	NCM335	NCM535	NCM545	PC2010	PC3700	PC6510	PC9630	PC9540		PC5300	PC5400	PD1010	ST30A	G10	H01	H05				
SDET	130504R-MA																								
	130508R-MF																								
	130508R-MM																								E19
SDXT	130508R-MF																								E20
	130508R-MM																								
	130508R-MA																								

Available arbors

Designation	Ød	NC arbors	Designation	Ød	NC arbors
FMPCM 4063S-□	22	BT□□-FMC22-□□	FMPC 4125S-□	38.1	BT□□-FMA38.1-□□
FMPC 4080S-□	25.4	BT□□-FMA25.4-□□	(FMPCM) 4125S-□	40	BT□□-FMB40-□□
	27	BT□□-FMC27-□□	4125S-25.4-□	25.4	BT□□-FMA25.4-□□
4100S-□	31.75	BT□□-FMA31.75-□□	4160S-□	50.8	BT□□-FMA38.1-□□
	32	BT□□-FMC32-□□		40	BT□□-FMB/FMC40-□□
4100S-25.4-□	25.4	BT□□-FMA25.4-□□	4200S-□	47.625	BT□□-FMA47.625-□□
			4250S-□	60	BT□□-FMB60-□□
			4315S-□	60	BT□□-FMB60-□□

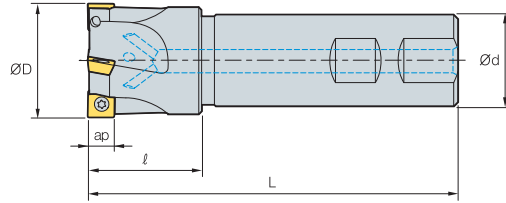
Parts

Specification							
Ø63~Ø80	FTNC04509	TW20S	HW40L	LFMP4R1-A	DHA0825	CFMP3R14R1-A	PXMA0306
Ø100~Ø315	FTNC04509	TW20S	HW40L	LFMP4R-A	DHA0830	CFMP4R-A	PXMA0306

Available inserts E19, E20

Available arbors and bolt E426~E428

FMPS3000

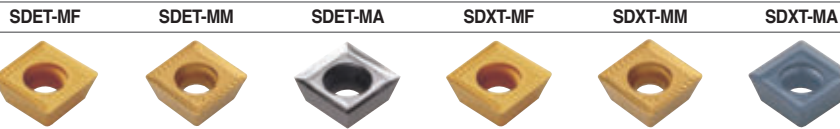


• AR: 10°
• RR: -9°~8°

(mm)

Designation		ØD	Ød	l	L	ap	
FMPS	3025HS	2	25	25	35	115	0.4
	3032HS	3	32	25	40	125	0.5
	3040HS	4	40	32	40	130	0.8
	3040HS-S40	4	40	40	45	140	1.2
	3040HS-S42	4	40	42	45	140	1.3
	3050HS	5	50	32	40	135	1
	3050HS-S40	5	50	40	40	140	1.3
	3050HS-S42	5	50	42	40	140	1.4
	3063HS	6	63	32	45	135	1.2
	3063HS-S40	6	63	40	45	145	1.6
	3063HS-S42	6	63	42	45	145	1.7

Available inserts

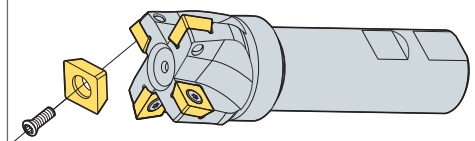


Designation	Cermet		Coated											Uncoated				page		
	CN2500	CN30	NC5330	NCM325	NCM335	NCM535	NCM545	PC2010	PC3700	PC6510	PC9530	PC9540	PC5300	PC5400	PD2000	ST30A	G10		H01	H05
SDET	09M402R-MA																			
	09M405R-MF																			
	09M405R-MM																			
SDXT	09M405R-MF																			E19
	09M405L-MF																			E20
	09M405R-MM																			
	09M405L-MM																			
	09M405R-MA																			

Parts

Specification		
Ø25~Ø63	FTGA03508	TW15S

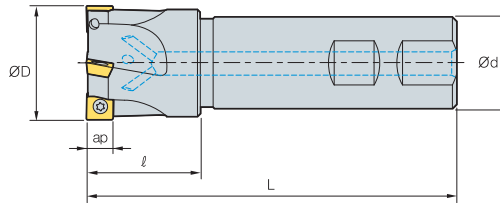
Assembling



Available inserts E19, E20

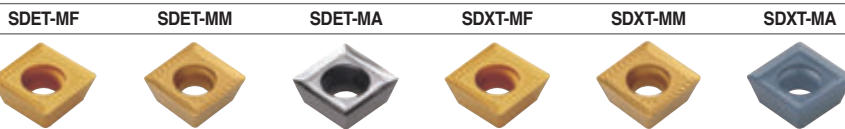


FMPS4000



Designation			ØD	Ød	ℓ	L	ap	
FMPS	4040HS	3	40	32	40	130	11	1
	4040HS-S40	3	40	40	40	140	11	1.3
	4040HS-S42	3	40	42	40	140	11	1.4
	4050HS	4	50	32	45	135	11	1.5
	4050HS-S40	4	50	40	45	145	11	1.7
	4050HS-S42	4	50	42	45	145	11	1.6
	4063HS	5	63	32	45	135	11	2.1
	4063HS-S40	5	63	40	45	145	11	2.4
4063HS-S42	5	63	42	45	145	11	2.6	

Available inserts

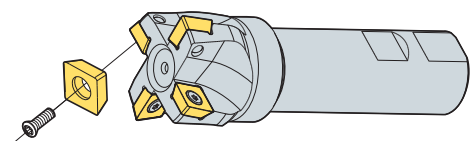


Designation	Cermet		Coated										Uncoated				page				
	CN2500	CN30	NC5330	NCM325	NCM335	NCM535	NCM545	PC2010	PC3700	PC6510	PC9530	PC9540	PC5300	PC5400	PD1010	ST30A		G10	H01	H05	
SDET	130504R-MA														●			●	●	E19	
	130508R-MF																				E20
	130508R-MM																				
SDXT	130508R-MF			●						●	●		●	●							
	130508R-MM			●	●				●	●	●		●	●							
	130508R-MA																	●	●		

Parts

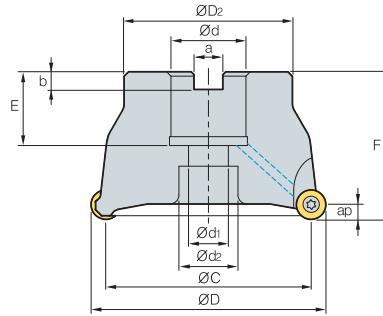
Specification		
Ø40~Ø63	FTNC04511	TW20S

Assembling



Available inserts E19, E20

FMRC(M)3000



• AR: 5°
• RR: -5°

(mm)

Designation		ØD	ØC	ØD ₂	Ød	a	b	E	F	Ød ₁	Ød ₂	ap	kg	
FMRCM	3040HRD	3	40	30	36	16	8.4	5.6	18	40	9	14	5.0	0.2
	3040HRD-H	4	40	30	36	16	8.4	5.6	18	40	9	14	5.0	0.2
	3050HRD	4	50	40	42	22	10.4	6.3	20	40	11	16.5	5.0	0.3
	3050HRD-H	5	50	40	42	22	10.4	6.3	20	40	11	16.5	5.0	0.3
	3063HRD	5	63	53	49	22	10.4	6.3	20	50	11	16.5	5.0	0.64
	3063HRD-H	6	63	53	49	22	10.4	6.3	20	50	11	16.5	5.0	0.64
FMRC (FMRCM)	3080HRD	6	80	70	57	25.4 (27)	9.5 (12.4)	6 (7.0)	25 (22)	50 (50)	14	19	5.0	1.1
	3080HRD-H	7	80	70	57	25.4 (27)	9.5 (12.4)	6 (7.0)	25 (22)	50 (50)	14	19	5.0	1.1
	3100HRD	7	100	90	67	31.75 (32)	12.7 (14.4)	8 (8.0)	32 (28)	63 (63)	18	26	5.0	2.1
	3100HRD-H	8	100	90	67	31.75 (32)	12.7 (14.4)	8 (8.0)	32 (28)	63 (63)	18	26	5.0	2.1

Note) It's general that you measure of inner diameter when the diameter of FMRC/FMRCM is Ø40~Ø63

()Metric size

Available inserts

RDKT-MF RDKT-MM RDCT-MA



Designation	Cermet		Coated										Uncoated		page		
	CN2500	CN30	NC5330	NCM325	NCM535	NCM545	PC2505	PC2010	PC3700	PC6510	PC9530	PC9540	PC5300	PC5400		ST30A	H01
RDCT 10T3M0-MA																●	E16 E17
RDKT 10T3M0-MF																	
10T3M0-MM				●					●	●	●		●				

Available arbors

Designation	Ød	NC arbors
FMRCM 3040HRD	16	BT□□-FMC16-□□
3040HRD-H		
3050HRD		
3050HRD-H		
3063HRD		
3063HRD-H		
FMRC 3080HRD	25.4	BT□□-FMA/FMB25.4-□□
(FMRCM) 3080HRD-H	27	BT□□-FMB/FMC27-□□
3100HRD	31.75	BT□□-FMA31.75-□□
3100HRD-H	32	BT□□-FMC32-□□

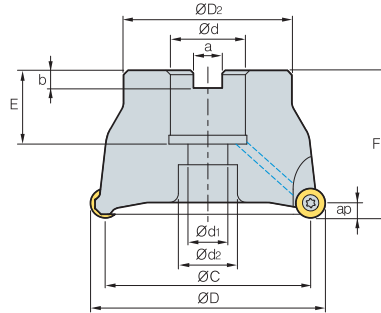
Parts

Specification	Screw	Wrench
Ø40~Ø100	FTGA03508	TW15S

Available inserts E16, E17 Available arbors and bolt E426-E428



FMRC(M)4000



• AR: 5°
• RR: -5°

(mm)

Designation		ØD	ØC	ØD ₂	Ød	a	b	E	F	Ød ₁	Ød ₂	ap		
FMRCM	4050HRD	4	50	38	42	22	10.4	6.3	20	50	11	18	6.0	0.4
	4063HRD	4	63	51	49	22	10.4	6.3	20	50	11	18	6.0	0.6
	4063HRD-M	5	63	51	49	22	10.4	6.3	20	50	11	18	6.0	0.6
FMRC (FMRCM)	4080HRD	5	80	68	57	25.4 (27)	9.5 (12.4)	6 (7.0)	25 (23)	50 (50)	14	20	6.0	1.0
	4080HRD-M	6	80	68	57	25.4 (27)	9.5 (12.4)	6 (7.0)	25 (23)	50 (50)	14	20	6.0	1.0
	4100HRD	6	100	88	67	31.75 (32)	12.7 (14.4)	8 (8.0)	33 (25)	63 (50)	18	26	6.0	1.9 (1.5)
	4100HRD-M	7	100	88	67	31.75 (32)	12.7 (14.4)	8 (8.0)	33 (25)	63 (50)	18	26	6.0	1.9 (1.5)
	4125HRD	7	125	113	87	38.1 (40)	15.9 (16.4)	10 (9.0)	35 (29)	63 (63)	22	32	6.0	3.0
4125HRD-M	8	125	113	87	38.1 (40)	15.9 (16.4)	10 (9.0)	35 (29)	63 (63)	22	32	6.0	3.0	

Note) It's general that you measure of inner diameter when the diameter of FMRC/FMRCM is Ø50~Ø63

() Metric size

Available inserts

RDKT-MF RDKT-MM RDCT-MA



Designation	Cermet		Coated										Uncoated		page			
	CN2500	CN30	NC5330	NCM325	NCM535	NCM545	PC2505	PC2010	PC3700	PC6510	PC9530	PC9540	PC5300	PC5400		ST30A	H01	
RDCT 1204M0-MA																	●	E16 E17
RDKT 1204M0-MF									●		●		●					
1204M0-MM				●					●	●	●		●					

Available arbors

Designation	Ød	NC arbors
FMRCM 4063HRD	22	BT□□-FMC22-□□
4063HRD-M		
FMRC 4080HRD	25.4	BT□□-FMA/FMB25.4-□□
(FMRCM) 4080HRD		
4080HRD-M	27	BT□□-FMB/FMC27-□□
4100HRD	31.75	BT□□-FMA31.75-□□
4100HRD-M	32	BT□□-FMC32-□□
4125HRD	38.1	BT□□-FMA/FMB38.1-□□
4125HRD-M	40	BT□□-FMB/FMC40-□□

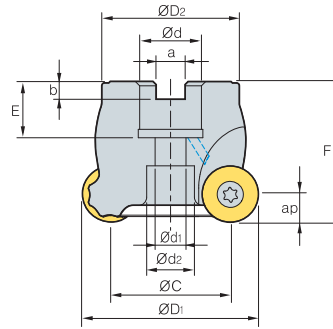
Parts

Specification		
Ø50~Ø125	FTKA0410	TW15S

Available inserts E16, E17

Available arbors and bolt E426~E428

FMRC(M)5000



• AR: 5°
• RR: -5°

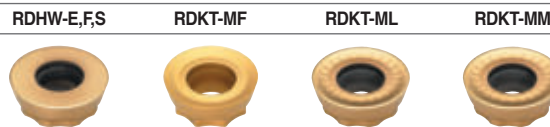
(mm)

Designation		ØD	ØC	ØD ₂	Ød	a	b	E	F	Ød ₁	Ød ₂	ap		
FMRCM	5050HRD	3	50	34	42	22	10.4	6.3	20	50	11	16.5	8.0	0.4
	5063HRD	4	63	47	49	22	10.4	6.3	20	50	11	18	8.0	0.6
	5063HRD-H	5	63	47	49	22	10.4	6.3	20	50	11	18	8.0	0.6
FMRC (FMRCM)	5080HRD	5	80	64	57	25.4 (27)	9.5 (12.4)	6 (7.0)	25 (23)	50 (50)	14	20	8.0	0.9
	5080HRD-H	6	80	64	57	25.4 (27)	9.5 (12.4)	6 (7.0)	25 (23)	50 (50)	14	20	8.0	0.9
	5100HRD	6	100	84	67	31.75 (32)	12.7 (14.4)	8 (8)	33 (25)	63 (50)	18	26	8.0	1.9 (1.4)
	5100HRD-H	7	100	84	67	31.75 (32)	12.7 (14.4)	8 (8)	33 (25)	63 (50)	18	26	8.0	1.9 (1.4)
	5125HRD	7	125	109	87	38.1 (40)	15.9 (16.4)	10 (9)	35 (29)	63 (63)	22	32	8.0	3
5125HRD-H	8	125	109	87	38.1 (40)	15.9 (16.4)	10 (9)	35 (29)	63 (63)	22	32	8.0	3	

Note) It's general that you measure of inner diameter when the diameter of FMRC/FMRCM is Ø50-Ø63

() Metric size

Available inserts



Designation	Cermet		Coated										Uncoated		page		
	CN2500	CN30	NC5330	NCM325	NCM535	NCM545	PC2505	PC2010	PC3700	PC6510	PC9530	PC9540	PC5300	PC5400		ST30A	H01
RDHW	1605MOE																E16
	1605MOF																
	1605MOS																
RDKT	1605M0-MM																E17
	1605M0-MF																
	1605M0-ML																

Available arbors

Designation	Ød	NC arbors
FMRCM	5050HRD	BT□□-FMC22-□□
	5063HRD	
	5063HRD-H	
FMRC (FMRCM)	5080HRD	BT□□-FMA/FMB25.4-□□
	5080HRD-H	BT□□-FMB/FMC27-□□
	5100HRD	BT□□-FMA31.75-□□
	5100HRD-H	BT□□-FMC32-□□
	5125HRD	BT□□-FMA/FMB38.1-□□
	5125HRD-H	BT□□-FMB/FMC40-□□

Parts

Specification		
Ø50~Ø125	FTGA0513-P	TW20-100

Available inserts E16, E17 Available arbors and bolt E426-E428



FMRC(M)6000

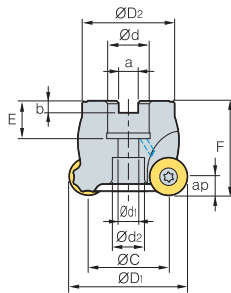


Fig. 1

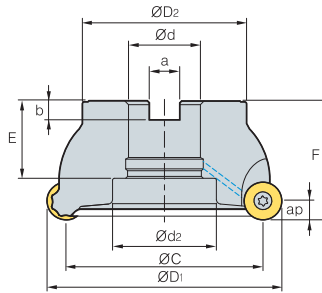


Fig. 2

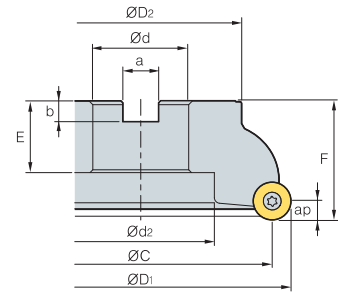


Fig. 3



• AR: 5°
• RR: -5°

(mm)

Designation	ØD	ØC	ØD2	Ød	a	b	E	F	Ød1	Ød2	ap		Fig.	
FMRCM 6063HRD	3	63	43	49	22	10.4	6.3	20	50	11	17	10.0	0.5	1
6063HRD-M	4	63	43	49	22	10.4	6.3	20	50	11	17	10.0	0.5	1
FMRC (FMRCM) 6080HRD	4	80	60	57	25.4 (27)	9.5 (12.4)	6 (7.0)	25 (22)	50	14	20	10.0	0.8	1
6080HRD-M	5	80	60	57	25.4 (27)	9.5 (12.4)	6 (7.0)	25 (22)	50	14	20	10.0	0.8	1
6100HRD	5	100	80	67	31.75 (32)	12.7 (14.4)	8 (8)	32 (28)	63	18	26	10.0	1.6	1
6100HRD-M	6	100	80	67	31.75 (32)	12.7 (14.4)	8 (8)	32 (28)	63	18	26	10.0	1.6	1
6125HRD	6	125	105	87	38.1 (40)	15.9 (16.4)	10 (9)	41 (29)	63	- (22)	55 (32)	10.0	2.7 (2.9)	2 (1)
6125HRD-M	7	125	105	87	38.1 (40)	15.9 (16.4)	10 (9)	41 (29)	63	- (22)	55 (32)	10.0	2.7 (2.9)	2 (1)
6160RD	7	160	140	107	50.8 (40)	19 (16.4)	11 (9)	38 (35)	63	-	78	10.0	4.4	3
6160RD-M	8	160	140	107	50.8 (40)	19 (16.4)	11 (9)	38 (35)	63	-	78	10.0	4.4	3

() Metric size

Available inserts

RDHW-E,F,S RDKT-MM



Designation	Cermet		Coated											Uncoated		page	
	CN2500	CN80	NC5300	NCM325	NCM535	NCM545	PC2505	PC2010	PC3700	PC6510	PC9530	PC9540	PC5300	PC5400	ST30A		H01
RDHW 2006M0E																	E16
2006M0F																	
2006M0S																	
RDKT 2006M0-MM								●									

Available arbors

Designation	Ød	NC arbors
FMRCM 6063HRD	22	BT□□-FMC22-□□
6063HRD-M		
FMRC (FMRCM) 6080HRD	25.4	BT□□-FMA/FMB25.4-□□
6080HRD-M		
6100HRD	31.75	BT□□-FMA31.75-□□
6100HRD-M		
6125HRD	38.1	BT□□-FMA/FMB38.1-□□
6125HRD-M		
6160RD	50.8	BT□□-FMA50.8-□□
6160RD-M		
6160RD-M	40	BT□□-FMB/FMC40-□□

Parts

Specification		
Ø63~Ø160	FTGA0515-P	TW20-100

Available inserts E16, E17

Available arbors and bolt E426~E428

FMRS1000/1500

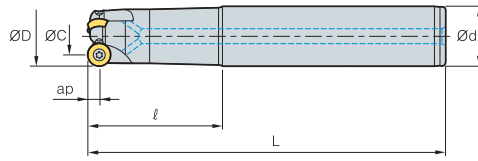


Fig. 1

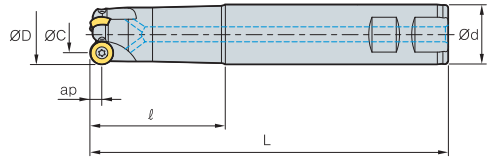


Fig. 2



• AR: 5°
• RR: -5°~1°

(mm)

Designation			ØD	ØC	Ød	ℓ	L	ap		Fig.
FMRS	1008HRD-M	1	8	5.5	10	30	80	2.5	0.2	1
	1008HRD-L	1	8	5.5	10	50	100	2.5	0.2	1
	1010HRD-M	1	10	5	12	44	100	2.5	0.2	1
	1010HRD-L	1	10	5	12	64	120	2.5	0.2	1
	1012HRD-M	2	12	7	12	44	100	2.5	0.3	1
	1012HRD-L	2	12	7	16	80	160	2.5	0.3	1
	1015HRD-M	3	15	10	16	80	160	2.5	0.3	1
	1015HRD-L	3	15	10	16	100	200	2.5	0.4	1
FMRS	1510HRD-M	1	10	6	12	44	100	3.0	0.2	1
	1510HRD-L	1	10	6	12	64	120	3.0	0.2	1
	1512HRD-M	2	12	6	12	54	110	3.0	0.3	1
	1512HRD-L	2	12	6	16	80	160	3.0	0.3	1
	1516HRD-M	3	16	10	16	60	130	3.0	0.3	1
	1516HRD-L	3	16	10	20	90	180	3.0	0.4	1
	1520HRD-M	3	20	14	20	80	150	3.0	0.4	1
	1520HRD-L	3	20	14	20	90	200	3.0	0.5	1

Available inserts

RDHW-E,FS RDKW



Type	Designation	Cermet		Coated										Uncoated		page		
		CN2500	CN30	NC5330	NCM325	NCM535	NCM545	PC2505	PC2010	PC3700	PC6510	PC9530	PC9540	PC5300	PC5400		ST30A	H01
1000 type	RDHW	0501M0E										●						E16 E17
		0501M0F																
		0501M0S																
1500 type	RDKW	0501M0E								●								
	RDHW	06T1M0E									●							
		06T1M0F																
		06T1M0S																
	RDKW	06T1M0E								●								

Parts

Specification		
Ø8~Ø15 (1000 type)	FTNA0203	TW06P
Ø10~Ø20 (1500 type)	FTNA02205	TW06P

Available inserts E16, E17



FMRS2000/2500

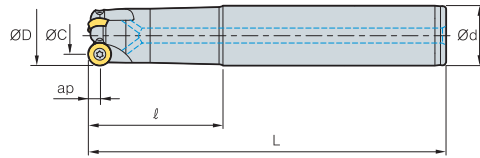


Fig. 1

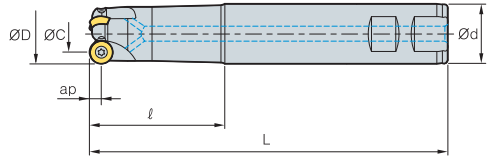


Fig. 2



• AR: 5°
• RR: -5°~1°

(mm)

Designation		ØD	ØC	Ød	ℓ	L	ap		Fig.	
FMRS	2015HRD-S	2	15	8	16	55	115	3.5	0.3	2
	2015HRD-M	2	15	8	20	80	150	3.5	0.4	1
	2015HRD-L	2	15	8	20	90	200	3.5	0.5	1
	2020HRD-S	3	20	14	20	65	125	3.5	0.3	2
	2020HRD-M	3	20	14	20	80	150	3.5	0.4	1
	2020HRD-L	3	20	14	25	90	200	3.5	0.5	1
FMRS	2516HRD-S	2	16	8	16	65	125	4.0	0.3	2
	2516HRD-M	2	16	8	16	80	150	4.0	0.4	1
	2516HRD-L	2	16	8	20	90	200	4.0	0.5	1
	2520HRD-S	2	20	12	20	65	125	4.0	0.4	2
	2520HRD-M	2	20	12	20	80	150	4.0	0.5	1
	2520HRD-L	2	20	12	25	90	200	4.0	0.6	1
	2525HRD-S	3	25	17	25	55	125	4.0	0.5	2
	2525HRD-M	3	25	17	25	90	200	4.0	0.6	1
	2525HRD-L	3	25	17	32	110	250	4.0	0.7	1

Available inserts

RDHW-E,F,S RDKW



Type	Designation	Cermet		Coated										Uncoated		page			
		CN2500	CN30	NC5330	NCM325	NCM535	NCM545	PC2505	PC2010	PC3700	PC6510	PC9530	PC9540	PC5300	PC5400		ST30A	H01	
2000 type	RDHW	0702M0E																	E16
		0702M0F																	
		0702M0S																	
2500 type	RDKW	0702M0E																	E17
	RDHW	0803M0E																	
		0803M0F																	
		0803M0S																	
	RDKW	0803M0E																	

Parts

Specification		
Ø15-Ø20 (2000 type)	FTNA02555	TW07S
Ø16-Ø25 (2500 type)	FTNA0305	TW09S
	FTNA0306 (Ø20 over)	

Available inserts E16, E17

FMRS3000

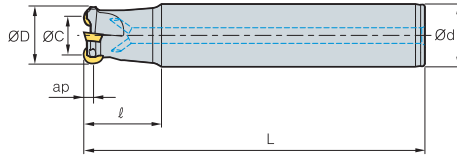


Fig. 1

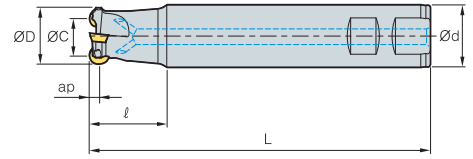


Fig. 2



• AR: 5°
• RR: -8°~-5°

(mm)

Designation		ØD	ØC	Ød	ℓ	L	ap		Fig.	
FMRS	3021HRD-M	1	21	11	20	40	150	5	0.4	1
	3021HRD-M2	2	21	11	20	40	150	5	0.4	1
	3021HRD-L	1	21	11	20	50	200	5	0.6	1
	3021HRD-L2	2	21	11	20	50	200	5	0.6	1
	3025HRD-S	2	25	15	25	35	115	5	0.5	2
	3025HRD-M	2	25	15	25	70	200	5	0.7	1
	3025HRD-L	2	25	15	25	100	250	5	1	1
	3026HRD-M	2	26	16	25	70	200	5	0.65	1
	3026HRD-L	2	26	16	25	100	250	5	0.7	1
	3032HRD-S	3	32	22	32	40	125	5	1	2
	3032HRD-M	3	32	22	32	70	200	5	1.3	1
	3032HRD-L	3	32	22	32	150	300	5	1.6	1
	3040HRD-S	4	40	30	32	40	125	5	1.3	2
	3040HRD-M	4	40	30	32	70	200	5	1.5	1
3040HRD-L	4	40	30	32	150	300	5	1.8	1	

Available inserts

RDKT-MF RDKT-MM RDCT-MA



Designation	Cermet		Coated										Uncoated		page		
	CN2500	CN30	NC5330	NCM325	NCM535	NCM545	PC2505	PC2010	PC3700	PC6510	PC9530	PC9540	PC5300	PC5400		ST30A	H01
RDCT 10T3M0-MA																	
RDKT 10T3M0-MF																	
10T3M0-MM				●					●	●	●		●				

Parts

Specification		
Ø21 Ø25-Ø40	FTGA03507 FTGA03508	TW15S

Available inserts E16, E17



FMRS4000

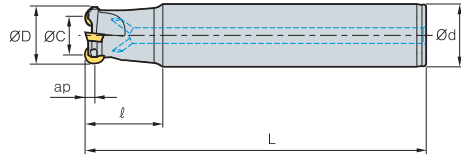


Fig. 1

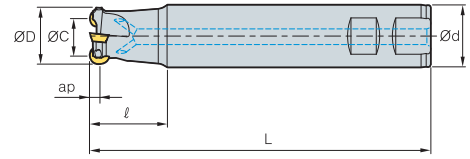


Fig. 2



• AR: 5°
• RR: -8°~5°

(mm)

Designation		ØD	ØC	Ød	ℓ	L	ap		Fig.
FMRS									
4032HRD-S	2	32	20	32	40	125	6	0.8	2
4032HRD-M	2	32	20	32	70	200	6	1.1	1
4032HRD-L	2	32	20	32	150	300	6	1.6	1
4033HRD-S	2	33	21	32	40	125	6	0.9	2
4033HRD-M	2	33	21	32	70	200	6	1.1	1
4033HRD-L	2	33	21	32	150	300	6	1.7	1
4040HRD-S	3	40	28	32	40	125	6	1	2
4040HRD-M	3	40	28	32	70	200	6	1.6	1
4040HRD-L	3	40	28	32	150	300	6	1.8	1
4040HRD-S40	3	40	28	40	40	125	6	1.3	2
4040HRD-M40	3	40	28	40	70	200	6	2	1
4040HRD-L40	3	40	28	40	150	300	6	2.4	1
4040HRD-S42	3	40	28	42	40	125	6	1.6	2
4040HRD-M42	3	40	28	42	70	200	6	2.4	1
4040HRD-L42	3	40	28	42	150	300	6	2.8	1
4050HRD-S	4	50	38	42	50	125	6	1.5	2
4050HRD-M	4	50	38	42	50	250	6	2.1	1
4050HRD-L	4	50	38	42	50	300	6	2.7	1
4050HRD-S40	4	50	38	40	50	150	6	2	2
4050HRD-M40	4	50	38	40	50	250	6	2.6	1
4050HRD-L40	4	50	38	40	50	300	6	3.2	1

Available inserts

RDKT-MF RDKT-MM RDCT-MA



Designation	Cermet		Coated										Uncoated		page		
	CN2500	CN30	NC5330	NCM325	NCM535	NCM545	PC2505	PC2010	PC3700	PC6510	PC9530	PC9540	PC5300	PC5400		ST30A	H01
RDCT 1204M0-MA																●	E16 E17
RDKT 1204M0-MF								●		●			●				
RDKT 1204M0-MM				●				●	●	●			●				

Parts

Specification		
Ø32~Ø50	FTKA0410	TW15S

Available inserts E16, E17

FMRS5000

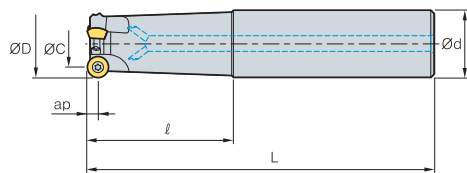


Fig. 1

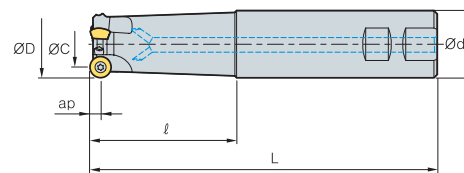


Fig. 2



• AR: 5°
• RR: -8°~5°

(mm)

Designation		ØD	ØC	Ød	ℓ	L	ap		Fig.
FMRS 5040HRD-S	2	40	24	32	40	125	8	1.4	2
5040HRD-M	2	40	24	32	70	200	8	1.8	1
5040HRD-L	2	40	24	32	150	300	8	2.0	1
5040HRD-S40	2	40	24	40	40	125	8	1.6	2
5040HRD-M40	2	40	24	40	70	200	8	2.0	1
5040HRD-L40	2	40	24	40	150	300	8	2.4	1
5040HRD-S42	2	40	24	42	40	125	8	2.0	2
5040HRD-M42	2	40	24	42	70	200	8	2.4	1
5040HRD-L42	2	40	24	42	150	300	8	2.8	1
5050HRD-S40	3	50	34	40	50	150	8	2.0	2
5050HRD-M40	3	50	34	40	50	250	8	2.4	1
5050HRD-L40	3	50	34	40	50	300	8	2.6	1
5050HRD-S	3	50	34	42	50	150	8	1.5	2
5050HRD-M	3	50	34	42	50	250	8	1.8	1
5050HRD-L	3	50	34	42	50	300	8	2.0	1
5063HRD-S40	4	63	47	40	50	150	8	1.7	2
5063HRD-M40	4	63	47	40	50	250	8	2.0	1
5063HRD-L40	4	63	47	40	50	300	8	2.3	1
5063HRD-S	4	63	47	42	50	150	8	1.6	2
5063HRD-M	4	63	47	42	50	250	8	1.8	1
5063HRD-L	4	63	47	42	50	300	8	2.0	1

Available inserts

RDHW-E,F,S RDKT-MF RDKT-ML RDKT-MM



Designation	Cermet		Coated											Uncoated		page	
	CN2500	CN30	NC5330	NCM325	NCM635	NCM545	PC2505	PC2010	PC3700	PC6510	PC9530	PC9540	PC5300	PC5400	ST30A		H01
RDHW 1605M0E																	E16
1605M0F																	
1605M0S																	
RDKT 1605M0-MF								●									E17
1605M0-MM																	
1605M0-ML																	

Parts

Specification		
Ø40~Ø63	FTGA0513-P	TW20-100

Available inserts E16, E17



FMRS6000

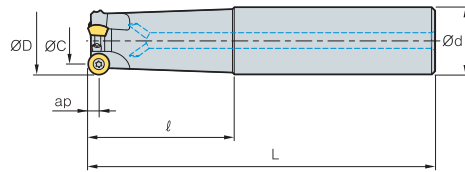


Fig. 1

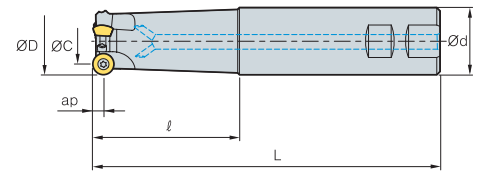


Fig. 2



• AR: 5°
• RR: -8°~5°

(mm)

Designation		ØD	ØC	Ød	l	L	ap		Fig.
FMRS	6050HRD-S40	3	50	31	40	50	150	1.3	2
	6050HRD-S42	3	50	31	42	50	150	1.4	2
	6050HRD-M40	3	50	31	40	50	250	2.2	1
	6050HRD-M42	3	50	31	42	50	250	2.4	1
	6050HRD-L40	3	50	31	40	50	300	2.7	1
	6050HRD-L42	3	50	31	42	50	300	3.0	1
	6063HRD-S40	4	63	44	40	50	150	1.5	2
	6063HRD-S42	4	63	44	42	50	150	1.6	2
	6063HRD-M40	4	63	44	40	50	250	2.5	1
	6063HRD-M42	4	63	44	42	50	250	2.7	1
	6063HRD-L40	4	63	44	40	50	300	3.0	1
	6063HRD-L42	4	63	44	42	50	300	3.2	1

Available inserts

RDHW-E,F,S RDKT-MM



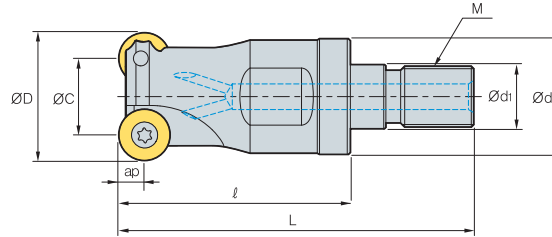
Designation	Cermet		Coated										Uncoated		page		
	CN2500	CN30	NC5330	NCM325	NCM535	NCM545	PC2505	PC2010	PC3700	PC6510	PC9530	PC9540	PC5300	PC5400		ST30A	H01
RDHW 2006M0E																	E16 E17
2006M0F																	
2006M0S																	
RDKT 2006M0-MM								●									

Parts

Specification		
Ø50~Ø63	FTGA0515-P	TW20-100

Available inserts E16, E17

FMRM1000/1500



• AR: 0°~5°
• RR: -5°~-1°

(mm)

Designation		ØD	ØC	Ød	Ød1	ℓ	L	M	ap		
FMRM	1008HRD-M06	1	8	5.5	9.5	6.5	25	40	M06	2.5	0.02
	1010HRD-M06	2	10	5	9.5	6.5	25	40	M06	2.5	0.02
	1012HRD-M06	2	12	7	11	6.5	25	40	M06	2.5	0.02
	1015HRD-M08	3	15	10	14.5	8.5	30	47	M08	2.5	0.04
FMRM	1510HRD-M06	1	10	7	9.5	6.5	25	40	M06	3.0	0.02
	1512HRD-M06	2	12	6	11	6.5	25	40	M06	3.0	0.02
	1516HRD-M08	3	16	10	14.5	8.5	30	47	M08	3.0	0.02
	1520HRD-M10	3	20	14	18	10.5	35	56	M10	3.0	0.07

Available inserts

RDHW-E,F,S RDKW



Type	Designation	Cermet		Coated										Uncoated		page			
		CN2500	CN30	NC5330	NCM325	NCM635	NCM545	PC2505	PC2010	PC3700	PC6510	PC9530	PC9540	PC5300	PC5400		ST30A	H01	
1000 type	RDHW	0501M0E																	
		0501M0F																	
		0501M0S																	
1500 type	RDKW	0501M0E																	E16
	RDHW	06T1M0E																	E17
		06T1M0F																	
	RDKW	06T1M0E																	

Available adaptor

Designation	Available adaptor
FMRM 1008HRD-M06	MAT-M06
1010HRD-M06	
1012HRD-M06	
1015HRD-M08	MAT-M08
1510HRD-M06	MAT-M06
1512HRD-M06	
1515HRD-M08	MAT-M08
1520HRD-M10	MAT-M10

Designation : FMRM1008HRD-M06
Modular head threading measure size (M06)

||

Adaptor spec.: MAT-M06-020-S10S
Adaptor threading measure (M06)

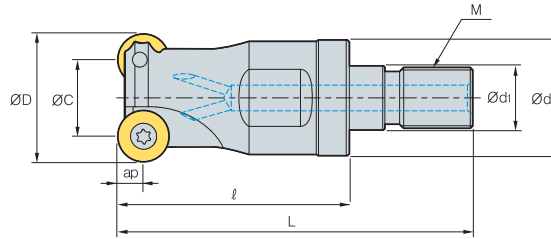
Parts

Specification		
Ø8~Ø15 (1000 type)	FTNA0203	TW06P
Ø10~Ø20 (1500 type)	FTNA02205	TW06P

Available inserts E16, E17 Available adaptor E401~E402



FMRM2000/2500



• AR: 0°~5°
• RR: -5°~1°

(mm)

Designation		ØD	ØC	Ød	Ød1	l	L	M	ap		
FMRM	2015HRD-M08	2	15	8	14.5	8.5	30	47	M08	3.5	0.04
	2020HRD-M10	3	20	13	18	10.5	35	56	M10	3.5	0.07
FMRM	2516HRD-M08	2	16	8	14.5	8.5	30	47	M08	4.0	0.04
	2520HRD-M10	2	20	12	18	10.5	35	56	M10	4.0	0.07
	2525HRD-M12	3	25	17	22.5	12.5	45	69	M12	4.0	0.13

Available inserts

RDHW-E,F,S RDKW



Type	Designation	Cermet		Coated										Uncoated		page		
		CN2500	CN30	NC5330	NCM325	NCM535	NCM545	PC2505	PC2010	PC3700	PC6510	PC9530	PC9540	PC5300	PC5400		ST30A	H01
2000 type	RDHW	0702M0E																E16 E17
		0702M0F																
		0702M0S																
2500 type	RDKW	0702M0E																
	RDHW	0803M0E																
		0803M0F																
		0803M0S																
	RDKW	0803M0E																

Available adaptor

Designation	Available adaptor
FMRM 2015HRD-M08	MAT-M08
FMRM 2020HRD-M10	MAT-M10
FMRM 2516HRD-M08	MAT-M08
FMRM 2520HRD-M10	MAT-M10
FMRM 2525HRD-M12	MAT-M12

Designation : FMRM2015HRD-M08
Modular head threading measure size (M08)

||

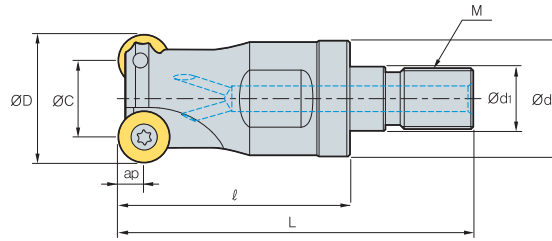
Adaptor spec.: MAT-M08-020-S16S
Adaptor threading measure (M08)

Parts

Specification		
Ø15~Ø20 (2000 type)	FTNA02555	TW07S
Ø16~Ø25 (2500 type)	FTNA0305	TW09S

Available inserts E16, E17 Available adaptor E401~E402

FMRM3000



• AR: 5°
• RR: -8°~5°

(mm)

Designation			ØD	ØC	Ød	Ød1	ℓ	L	M	ap	
FMRM	3021HRD-M10	2	21	11	18	10.5	35	56	M10	5.0	0.1
	3025HRD-M12	2	25	15	22.5	12.5	45	69	M12	5.0	0.15
	3032HRD-M16	3	32	22	29	17	50	77	M16	5.0	0.2
	3042HRD-M16	4	42	32	29	17	50	77	M16	5.0	0.24

Available inserts

RDHW-E,F,S RDCT-MA RDKT-MF RDKT-ML RDKT-MM



Designation	Cermet		Coated										Uncoated		page			
	CN2500	CN80	NC5330	NCM325	NCM535	NCM545	PC2505	PC2010	PC3700	PC6510	PC9530	PC9540	PC5300	PC5400		ST30A	H01	
RDCT 10T3M0-MA																	●	E16 E17
RDKT 10T3M0-MF																		
RDKT 10T3M0-MM				●					●	●	●		●					

Available adaptor

Designation	Available adaptor
FMRM 3021HRD-M10	MAT-M10
3025HRD-M12	MAT-M12
3032HRD-M16	MAT-M16
3042HRD-M16	

Designation : FMRM3021HRD-M10
Modular head threading measure size (M10)

II

Adaptor spec.: MAT-M10-030-S20S
Adaptor threading measure (M10)

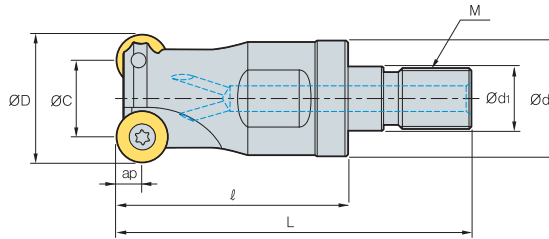
Parts

Specification		
Ø21 Ø25-Ø42	FTGA03507 FTGA03508	TW15S

Available inserts E16, E17 Available adaptor E401~E402



FMRM4000/5000



• AR: 5°
• RR: -8°~5°

(mm)

Designation		ØD	ØC	Ød	Ød ₁	ℓ	L	M	ap		
FMRM	4025HRD-M12	2	25	13	22.5	12.5	45	69	M12	6.0	0.12
	4032HRD-M16	2	32	20	29	17	50	77	M16	6.0	0.22
	4040HRD-M16	3	40	28	29	17	50	77	M16	6.0	0.23
	4042HRD-M16	4	42	28	29	17	50	77	M16	6.0	0.25
FMRM	5040HRD-M16	2	40	24	29	17	50	77	M16	8.0	0.25

Available inserts



Type	Designation	Cermet		Coated										Uncoated		page		
		CN2500	CN80	NC5330	NCM325	NCM635	NCM545	PC2505	PC2010	PC3700	PC6510	PC9530	PC9540	PC5300	PC5400		ST30A	H01
4000 type	RDCT 1204M0-MA																	
	RDKT 1204M0-MF																	
	RDKT 1204M0-MM																	
5000 type	RDHW 1605M0-E																	
	RDKT 1605M0-MF																	
	RDKT 1605M0-ML																	
	RDKT 1605M0-MM																	

Available adaptor

Designation	Available adaptor
FMRM 4025HRD-M12	MAT-M12
4032HRD-M16	MAT-M16
4040HRD-M16	
4042HRD-M16	
5040HRD-M16	MAT-M16

Designation : FMRM4025HRD-M12
Modular head threading measure size (M12)

||

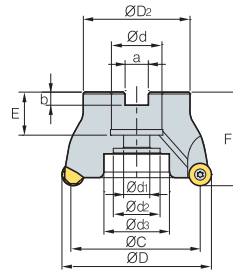
Adaptor spec.: MAT-M12-030-S25S
Adaptor threading measure (M12)

Parts

Specification		
Ø25~Ø42 (4000 type)	FTKA0410	TW15S
Ø40 (5000 type)	FTGA0513-P	TW20-100

Available inserts E16, E17 Available adaptor E401~E402

FMRCM3000 new



• AR: 5°
• RR: -4°~ 0°

(mm)

Designation	ØD	ØC	ØD ₂	Ød	Ød ₁	Ød ₂	d ₃	a	b	E	F	ap			
FMRCM	3040HRP-5	5	40	30	38	16	9	14	-	8.4	5.6	19	40	5	0.22
	3050HRP-6	6	50	40	45	22	11	18	-	10.4	6.3	20	40	5	0.35
	3052HRP-6	6	52	42	45	22	11	18	-	10.4	6.3	20	40	5	0.37
	3063HRP-6	6	63	53	50	22	11	18	-	10.4	6.3	20	40	5	0.55
	3063HRP-7	7	63	53	50	22	11	18	-	10.4	6.3	20	40	5	0.56
	3066HRP-7	7	66	56	50	22	11	18	-	10.4	6.3	20	40	5	0.60

Available inserts



Designation	Cermet		Coated										Uncoated		page		
	CN2500	CN30	NC5330	NCM325	NCM535	NCM545	PC2505	PC2510	PC3700	PC6510	PC9530	PC9540	PC5300	PC5400		ST30A	H01
RPCT 10T3M0-MA																	
RPET 10T3M0E-ML													●	●		●	
RPMT 10T3M0E-MF													●	●			
10T3M0S-MM							●	●	●				●	●			
RPMW 10T3M0E1							●	●					●	●			

Available arbors

Designation	Ød	Available arbors
FMRCM 3040HRP-5	16	BT□□-FMC16-□□
3050HRP-6	22	BT□□-FMC22-□□
3052HRP-6		
3063HRP-6		
3063HRP-7		
3066HRP-7		

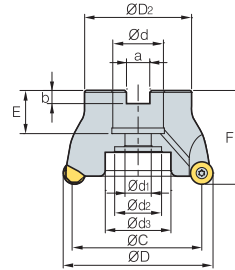
Parts

Specification		
Ø40~Ø66	FTGA03508	TW15S

Available inserts E17, E18 Available arbors and bolt E426~E428



FMRC(M)4000 new



• AR: 5°
• RR: -2°~0°

(mm)

Designation	ØD	ØC	ØD ₂	Ød	Ød ₁	Ød ₂	Ød ₃	a	b	E	F	ap			
FMRCM	4050HRP-4	4	50	38	45	22	11	18	-	10.4	6.3	20	40	6	0.26
	4050HRP-5	5	50	38	45	22	11	18	-	10.4	6.3	20	40	6	0.28
	4052HRP-5	5	52	40	45	22	11	18	-	10.4	6.3	20	40	6	0.30
	4063HRP-5	5	63	51	50	22	11	18	-	10.4	6.3	20	40	6	0.44
	4063HRP-6	6	63	51	50	22	11	18	-	10.4	6.3	20	40	6	0.48
	4066HRP-6	6	66	54	50	22	11	18	-	10.4	6.3	20	40	6	0.50
FMRC (FMRCM)	4080HRP-6	6	80	68	57	25.4 (27)	14	25	35	9.5 (12.4)	6 (7)	24 (23)	50	6	0.92
	4080HRP-7	7	80	68	57	25.4 (27)	14	25	35	9.5 (12.4)	6 (7)	24 (23)	50	6	0.90
	4100HRP-7	7	100	88	67	31.75 (32)	18	26	42	12.7 (14.4)	8 (8)	32 (25)	63 (53)	6	1.46

() Metric size

Available inserts



Designation	Cermet		Coated											Uncoated		page		
	CN2500	CN30	NC5330	NCM325	NCM535	NCM545	PC2505	PC2510	PC3700	PC6510	PC9530	PC9540	PC5300	PC5400	ST30A		H01	
RPCT	1204M0-MA																	
RPET	1204M0E-ML																	
RPMT	1204M0E-MF																	
	1204M0S-MM																	
RPMW	1204M0S1																	
	1204M0S2																	

Available arbors

Designation	Ød	Available arbors
FMRCM	4050HRP-4	BT□□-FMC22-□□
	4050HRP-5	
	4052HRP-5	
	4063HRP-5	
	4063HRP-6	
	4066HRP-6	
FMRC (FMRCM)	4080HRP-6	BT□□-FMA25.4-□□
		BT□□-FMC27-□□
	4080HRP-7	BT□□-FMA25.4-□□
		BT□□-FMC27-□□
	4100HRP-7	BT□□-FMA31.75-□□
	BT□□-FMC32-□□	

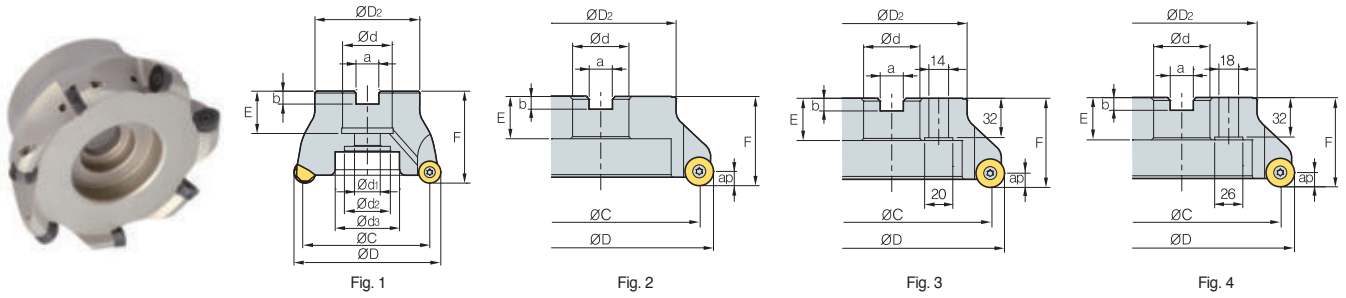
Parts

Specification		
Ø50~Ø100	FTKA0410	TW15S

Available inserts E17, E18

Available arbors and bolt E426~E428

FMRC(M)5000 new



Designation	ØD	ØC	ØD2	Ød	Ød1	Ød2	Ød3	a	b	E	F	ap	$\frac{kg}{m^3}$	Fig.		
FMRCM	5063HRP-4	4	63	47	50	22	11	18	-	10.4	6.3	20	40	8	0.43	1
	5063HRP-5	5	63	47	50	22	11	18	-	10.4	6.3	20	40	8	0.44	1
	5066HRP-5	5	66	50	50	22	11	18	-	10.4	6.3	20	40	8	0.48	1
FMRC (FMRCM)	5080HRP-5	5	80	64	57	25.4 (27)	14	25	35	9.5 (12.4)	6 (7)	24 (23)	50	8	0.77	1
	5080HRP-6	6	80	64	57	25.4 (27)	14	25	35	9.5 (12.4)	6 (7)	24 (23)	50	8	0.82	1
	5100HRP-6	6	100	84	67	31.75 (32)	18	26	42	12.7 (14.4)	8 (8)	32 (25)	63 (55)	8	1.42	1
	5125HRP-7	7	125	109	87	38.1 (40)	22	32	52	15.9 (16.4)	10 (9)	35 (29)	68 (63)	8	2.78	1
	5125HRP-8	8	125	109	87	38.1 (40)	22	32	52	15.9 (16.4)	10 (9)	35 (29)	68 (63)	8	2.79	1
5160RP-8	8	160	144	107	50.8 (40)	-	-	100	19 (16.4)	11 (9)	38 (32)	63	8	4.01	2(3)	

() Metric size

Available inserts

Designation	RPCT-MA		RPET-ML			RPMT-MF			RPMT-MM			RPMW		page		
	CN2500	CN30	NC6330	NCM825	NCM635	NCM645	PC2505	PC2510	PC3700	PC6510	PC9530	PC9540	PC5300		PC5400	ST30A
RPCT 1606M0-MA																
RPET 1606M0E-ML																
RPMT 1606M0E-MF																
1606M0S-MM																
RPMW 1606M0S1																

Available arbors

Designation	Ød	Available arbors
FMRCM	5063HRP-4	BT□□-FMC22-□□
	5063HRP-5	
	5066HRP-5	
FMRC (FMRCM)	5080HRP-5	BT□□-FMA25.4-□□ BT□□-FMC27-□□
	5080HRP-6	BT□□-FMA25.4-□□ BT□□-FMC27-□□
5100HRP-6	31.75	BT□□-FMA31.75-□□ BT□□-FMC32-□□
5125HRP-7	38.1	BT□□-FMA38.1-□□ BT□□-FMC40-□□
5125HRP-8	38.1	BT□□-FMA38.1-□□ BT□□-FMC40-□□
	40	BT□□-FMA40-□□ BT□□-FMC40-□□
5160RP-8	50.8	BT□□-FMA50.8-□□ BT□□-FMC40-□□
	40	BT□□-FMC40-□□

Parts

Specification	Screw	Wrench
Ø63~Ø160	FTGA0512-P	TW20-100

Available inserts E17, E18 Available arbors and bolt E426~E428



FMRC(M)6000 new

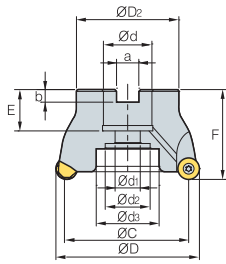


Fig. 1

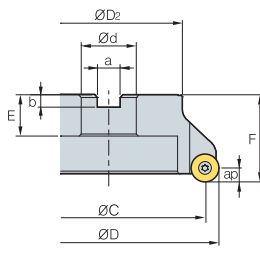


Fig. 2

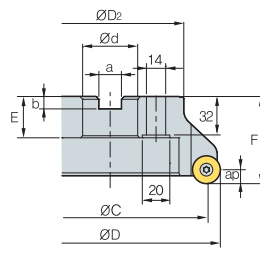


Fig. 3

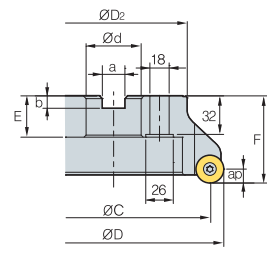


Fig. 4



• AR: 5°
• RR: 0°

(mm)

Designation	ØD	ØC	ØD ₂	Ød	Ød ₁	Ød ₂	Ød ₃	a	b	E	F	ap	kg	Fig.	
FMRCM 6063HRP-4	4	63	43	50	22	11	18	-	10.4	6.3	20	40	10	0.37	1
FMRC 6080HRP-5	5	80	60	57	25.4 (27)	14	25	35	9.5 (12.4)	6 (7)	24 (23)	50	10	0.87	1
(FMRCM) 6100HRP-5	5	100	80	67	31.75 (32)	18	26	42	12.7 (14.4)	8 (8)	32 (25)	63 (55)	10	1.31	1
6100HRP-6	6	100	80	67	31.75 (32)	18	26	42	12.7 (14.4)	8 (8)	32 (25)	63 (55)	10	1.40	1
6125HRP-5	5	125	105	87	38.1 (40)	22	32	52	15.9 (16.4)	10 (9)	35 (29)	68 (63)	10	2.77	1
6125HRP-7	7	125	105	87	38.1 (40)	22	32	52	15.9 (16.4)	10 (9)	35 (29)	68 (63)	10	2.89	1
6160RP-6	6	160	140	107	50.8 (40)	-	-	100	19 (16.4)	11 (9)	38 (32)	63	10	3.58	2 (3)
6160RP-8	8	160	140	107	50.8 (40)	-	-	100	19 (16.4)	11 (9)	38 (32)	63	10	3.53	2 (3)
6200RP-8	8	200	180	130	47.625 (60)	-	-	132	25.4 (25.7)	14 (14)	38	63	10	5.15	4
6250RP-9	9	250	230	180	47.625 (60)	-	-	180	25.4 (25.7)	14 (14)	38	63	10	9.72	4

() Metric size

Available inserts



Designation	Cermet		Coated										Uncoated		page		
	CN2500	CN30	NC5330	NCM325	NCM635	NCM645	PC2505	PC2510	PC3700	PC6510	PC9530	PC9540	PC5300	PC5400		ST300A	H01
RPCT 2007M0-MA																	
RPET 2007M0E-ML													●	●			E17
RPMT 2007M0E-MF													●	●			E18
2007M0S-MM							●	●	●				●	●			
RPMW 2007M0S1							●	●					●	●			

Available arbors

Designation	Ød	NC arbors
FMRCM 6063HRP-4	22	BT□□-FMC22-□□
FMRC 6080HRP-5	25.4	BT□□-FMA25.4-□□
	27	BT□□-FMC27-□□
6100HRP-5	31.75	BT□□-FMA31.75-□□
	32	BT□□-FMC32-□□
6100HRP-6	31.75	BT□□-FMA31.75-□□
	32	BT□□-FMC32-□□
6125HRP-5	38.1	BT□□-FMA38.1-□□
	40	BT□□-FMC40-□□

Designation	Ød	NC arbors
FMRC 6125HRP-7	38.1	BT□□-FMA38.1-□□
	40	BT□□-FMC40-□□
6160RP-6	50.8	BT□□-FMA50.8-□□
	40	BT□□-FMC40-□□
6160RP-8	50.8	BT□□-FMA50.8-□□
	40	BT□□-FMC40-□□
6200RP-8	47.625	BT□□-FMA47.625-□□
	60	BT□□-FMC60-□□
6250RP-9	47.625	BT□□-FMA47.625-□□
	60	BT□□-FMC60-□□

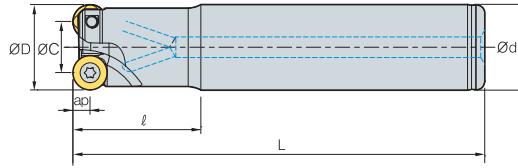
Parts

Specification		
Ø63~Ø250	FTKA0615-P	TW25-100

Available inserts E17, E18

Available arbors and bolt E426~E428

FMRS2500 new



• AR: -4°
• RR: -4°~1°

(mm)

Designation			ØD	ØC	Ød	l	L	ap	
FMRS	2517HRP-2S16	2	17	9	16	35	90	4	0.11
	2517HRP-2M16	2	17	9	16	35	150	4	0.20
	2517HRP-2L16	2	17	9	16	35	200	4	0.27
	2518HRP-2M16	2	18	10	16	35	150	4	0.20
	2518HRP-2L16	2	18	10	16	35	200	4	0.28
	2520HRP-3S20	3	20	12	20	35	130	4	0.27
	2520HRP-3M20	3	20	12	20	100	180	4	0.36
	2520HRP-3L20	3	20	12	20	130	250	4	0.50
	2521HRP-3S20	3	21	13	20	35	130	4	0.28
	2521HRP-3M20	3	21	13	20	35	180	4	0.40
	2521HRP-3L20	3	21	13	20	35	250	4	0.55
	2525HRP-4S25	4	25	17	25	35	150	4	0.48
	2525HRP-4M25	4	25	17	25	60	180	4	0.60
	2525HRP-4L25	4	25	17	25	130	250	4	0.81
	2526HRP-4S25	4	26	18	25	35	150	4	0.48
2526HRP-4L25	4	26	18	25	130	250	4	0.85	

Available inserts



Designation	Cermet		Coated										Uncoated		page		
	CN2500	CN30	NC5330	NCM325	NCM635	NCM545	PC2505	PC2510	PC3700	PC6510	PC9530	PC9540	PC5300	PC5400		ST30A	H01
RPET 0803M0E-ML													●	●			E17 E18
RPMT 0803M0E-MF													●	●			
0803M0S-MM							●	●					●	●			
RPMW 0803M0E1							●	●					●	●			

Parts

Specification		
Ø17 Ø18~Ø26	FTNA0305 FTNA0306	TW09S

Available inserts E17, E18



FMRS3000 new

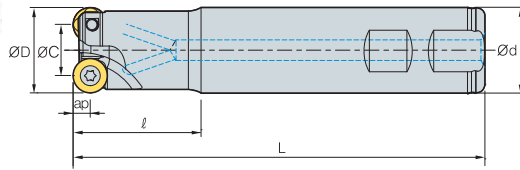


Fig. 1

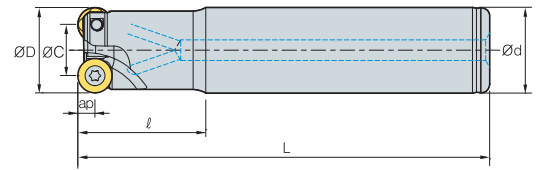


Fig. 2



• AR: -4°
• RR: -1°

(mm)

Designation		ØD	ØC	Ød	ℓ	L	ap		Fig.
FMRS 3025HRP-2M20	2	25	15	20	40	170	5	0.40	2
3025HRP-2S25	2	25	15	25	40	120	5	0.39	1
3025HRP-2M25	2	25	15	25	60	160	5	0.52	2
3025HRP-2L25	2	25	15	25	130	250	5	0.80	2
3026HRP-2L25	2	26	16	25	30	200	5	0.69	2
3032HRP-3S32	3	32	22	32	40	125	5	0.68	1
3032HRP-3L32	3	32	22	32	60	200	5	1.08	2
3032HRP-4S32	4	32	22	32	40	125	5	0.66	1
3032HRP-4L25	4	32	22	25	60	200	5	0.74	2
3033HRP-4S32	4	33	23	32	40	125	5	0.67	1
3033HRP-4M32	4	33	23	32	60	180	5	1.00	2
3033HRP-4L32	4	33	23	32	180	300	5	1.64	2

Available inserts



Designation	Cermet		Coated										Uncoated		page		
	CN2500	CN30	NC5330	NCM325	NCM535	NCM545	PC2505	PC2510	PC3700	PC6510	PC9530	PC9540	PC5300	PC5400		ST30A	H01
RPCT 10T3M0-MA																	
RPET 10T3M0E-ML													●	●		●	
RPMT 10T3M0E-MF													●	●			
10T3M0S-MM							●	●	●				●	●			
RPMW 10T3M0E1							●	●					●	●			

Parts

Specification		
Ø25~Ø26	FTGA03507	TW15S
Ø32~Ø33	FTGA03508	

Available inserts E17, E18

FMRS4000 new

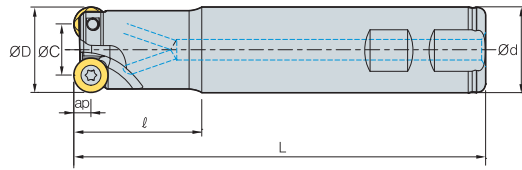


Fig. 1

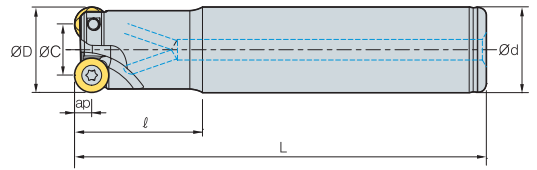


Fig. 2



• AR: -4°
• RR: -2°~ 0°

(mm)

Designation		ØD	ØC	Ød	l	L	ap		Fig.
FMRS 4025HRP-2S25	2	25	13	25	60	160	6	0.46	1
4026HRP-2L25	2	26	14	25	60	200	6	0.48	2
4032HRP-2L25	2	32	20	25	40	190	6	0.68	2
4032HRP-2S32	2	32	20	32	50	125	6	0.64	1
4032HRP-2L32	2	32	20	32	50	250	6	1.40	2
4032HRP-3S32	3	32	20	32	50	125	6	0.64	1
4032HRP-3M32	3	32	20	32	60	160	6	0.85	2
4033HRP-3M32	3	33	21	32	60	200	6	1.01	2
4033HRP-3L32	3	33	21	32	60	300	6	1.67	2
4040HRP-3S32	3	40	28	32	35	105	6	0.60	1
4040HRP-3M32	3	40	28	32	50	160	6	0.96	2
4040HRP-4S32	4	40	28	32	35	105	6	0.60	1
4040HRP-4M32	4	40	28	32	35	150	6	0.87	2
4040HRP-4L32	4	40	28	32	35	250	6	1.46	2
4050HRP-4M32	4	50	38	32	50	150	6	1.10	2
4050HRP-4M40	4	50	38	40	50	150	6	1.44	2
4050HRP-4M42	4	50	38	42	50	150	6	1.55	2

Available inserts

RPCT-MA RPET-ML RPMT-MF RPMT-MM RPMW



Designation	Cermet		Coated								Uncoated		page				
	CN2500	CN30	NC5330	NCM325	NCM635	NCM645	PC2505	PC2510	PC3700	PC6510	PC9530	PC9540		PC5300	PC5400	ST30A	H01
RPCT 1204M0-MA																	
RPET 1204M0E-ML													●	●			
RPMT 1204M0E-MF												●	●	●			E17
1204M0S-MM							●	●	●			●	●	●			E18
RPMW 1204M0S1							●	●	●				●	●			
1204M0S2													●	●			

Parts

Specification		
Ø25-Ø26	FTKA0408	TW15S
Ø32-Ø50	FTKA0410	TW15S



FMRS5000/6000 **new**

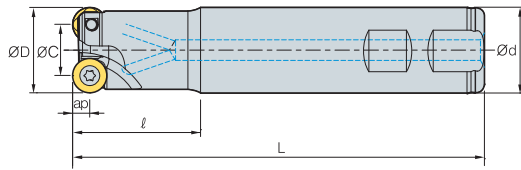


Fig. 1

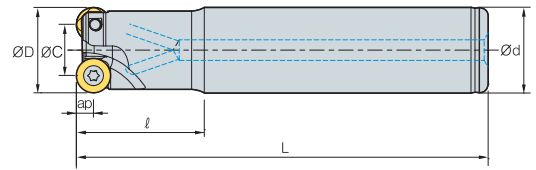


Fig. 2



• AR: -4°
• RR: 0°

(mm)

Designation		ØD	ØC	Ød	l	L	ap		Fig.	
FMRS	5040HRP-2M32	2	40	24	32	50	160	8	0.92	2
	5040HRP-2L32	2	40	24	32	50	250	8	1.45	2
	5050HRP-3M40	3	50	34	40	50	160	8	1.48	2
	5050HRP-3L40	3	50	34	40	50	300	8	2.86	2
FMRS	6050HRP-3S32	3	50	30	32	50	160	10	1.06	1
	6050HRP-3M32	3	50	30	32	50	200	10	1.30	2
	6050HRP-3S40	3	50	30	40	50	125	10	1.45	1
	6050HRP-3M40	3	50	30	40	50	200	10	1.85	2

Available inserts



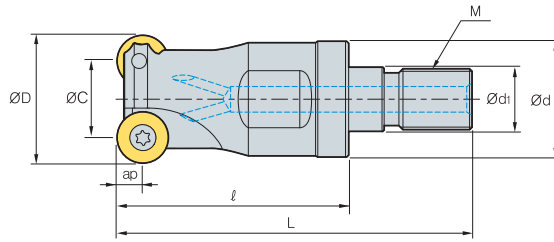
Type	Designation	Cermet		Coated										Uncoated		page		
		CN2500	CN30	NC5330	NCM325	NCM635	NCM545	PC2505	PC2510	PC3700	PC6510	PC9530	PC9540	PC5300	PC5400		ST30A	H01
5000 type	RPCT 1606M0-MA																●	E17
	RPET 1606M0E-ML													●	●			
	RPMT 1606M0E-MF													●	●			
	RPMT 1606M0S-MM							●	●	●				●	●			
RPMW 1606M0S1							●	●					●	●				
6000 type	RPCT 2007M0-MA																●	E18
	RPET 2007M0E-ML													●	●			
	RPMT 2007M0E-MF													●	●			
	RPMT 2007M0S-MM							●	●	●				●	●			
RPMW 2007M0S1							●	●					●	●				

Parts

Specification		
Ø40~Ø50 (5000 type)	FTGA0511-P	TW20-100
Ø50 (6000 type)	FTKA0615-P	TW25-100

Available inserts E17, E18

FMRM2500 new



• AR: -4°
• RR: -4°~ 0°

(mm)

Designation		ØD	ØC	Ød	Ød ₁	l	L	M	ap	
FMRM 2517HRP-M08	2	17	9	14.5	8.5	25	42	M08	4	0.03
2521HRP-M10	3	21	13	18	10.5	30	51	M10	4	0.06
2526HRP-M12	4	26	18	23	12.5	35	59	M12	4	0.11
2533HRP-M16	4	33	25	29	17	40	67	M16	4	0.22
2540HRP-M16	5	40	32	29	17	40	67	M16	4	0.26

Available inserts

		RPCT-MA	RPET-ML	RPMT-MF	RPMT-MM	RPMW											
Designation		Cermet		Coated						Uncoated		page					
		CN2500	CN30	NC5330	NCM325	NCM535	NCM545	PC2505	PC2510	PC3700	PC6510		PC9530	PC9540	PC5300	PC5400	ST30A
RPET	0803M0E-ML												●	●			E17 E18
RPMT	0803M0E-MF												●	●			
	0803M0S-MM												●	●			
RPMW	0803M0E1												●	●			

Available adaptor

Designation	Available adaptor
FMRM 2517HRP-M08	MAT-M08
2521HRP-M10	MAT-M10
2526HRP-M12	MAT-M12
2533HRP-M16	MAT-M16
2540HRP-M16	

Designation : FMRM2517HRP-M08
Modular head threading measure size (M08)

II

Adaptor spec.: MAT-M08-020-S16S
Adaptor threading measure (M08)

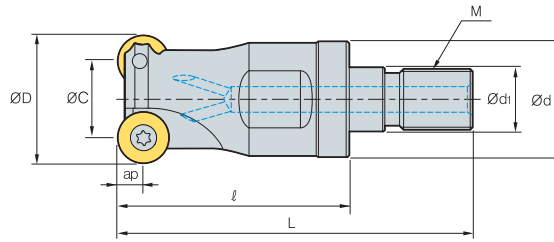
Parts

Specification		
Ø17 Ø21~Ø40	FTNA0305 FTNA0306	TW09S

Available inserts E17, E18 Available adaptor E401~E402



FMRM3000 new



• AR: -4°
• RR: -1°~0°

(mm)

Designation		ØD	ØC	Ød	Ød ₁	ℓ	L	M	ap	
FMRM 3026HRP-M12	2	26	16	23	12.5	35	59	M12	5	0.10
3033HRP-M16	3	33	23	29	17	40	67	M16	5	0.20
3035HRP-M16	3	35	25	29	17	40	67	M16	5	0.22
3040HRP-M16	3	40	30	29	17	40	67	M16	5	0.25
3042HRP-M16	3	42	32	29	17	40	67	M16	5	0.27

Available inserts



Designation	Cermet		Coated										Uncoated		page		
	CN2500	CN30	NC5330	NCM325	NCM535	NCM545	PC2505	PC2510	PC3700	PC6510	PC9530	PC9540	PC5300	PC5400		ST30A	H01
RPCT 10T3M0-MA																	
RPET 10T3M0E-ML													●	●			
RPMT 10T3M0E-MF													●	●			E17
10T3M0S-MM							●	●	●				●	●			E18
RPMW 10T3M0E1							●	●					●	●			

Available adaptor

Designation	Available adaptor
FMRM 3026HRP-M12	MAT-M12
3033HRP-M16	
3035HRP-M16	
3040HRP-M16	MAT-M16
3042HRP-M16	

Designation : FMRM3026HRP-M12
Modular head threading measure size (M12)

II

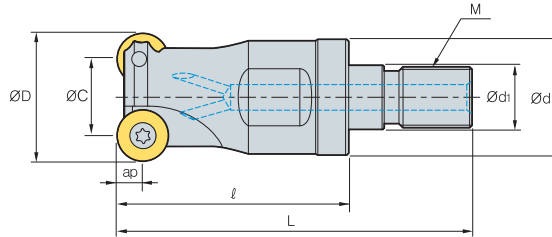
Adaptor spec.: MAT-M12-030-S25S
Adaptor threading measure (M12)

Parts

Specification		
Ø26	FTGA03507	TW15S
Ø33~Ø42	FTGA03508	

Available inserts E17, E18 Available adaptor E401~E402

FMRM4000 new



• AR: -4°
• RR: 0°

(mm)

Designation		ØD	ØC	Ød	Ød1	l	L	M	ap	
FMRM 4026HRP-M12	2	26	14	23	12.5	35	59	M12	6	0.10
4033HRP-M16	3	33	21	29	17	40	67	M16	6	0.21
4035HRP-M16	3	35	23	29	17	40	67	M16	6	0.21
4040HRP-M16	4	40	28	29	17	40	67	M16	6	0.24
4042HRP-M16	4	42	30	29	17	40	67	M16	6	0.25

Available inserts



Designation	Cermet		Coated								Uncoated		page				
	CN2500	CN30	NC5330	NCM325	NCM535	NCM545	PC2505	PC2510	PC3700	PC6510	PC9530	PC9540		PC5300	PC5400	ST30A	H01
RPCT 1204M0-MA																	
RPET 1204M0E-ML													●	●			
RPMT 1204M0E-MF												●	●	●			E17
1204M0S-MM												●	●	●			E18
RPMW 1204M0S1													●	●			
1204M0S2													●	●			

Available adaptor

Designation	Available adaptor
FMRM 4026HRP-M12	MAT-M12
4033HRP-M16	MAT-M16
4035HRP-M16	
4040HRP-M16	
4042HRP-M16	

Designation : FMRM4026HRP-M12
Modular head threading measure size (M12)

II

Adaptor spec.: MAT-M12-030-S25S
Adaptor threading measure (M12)

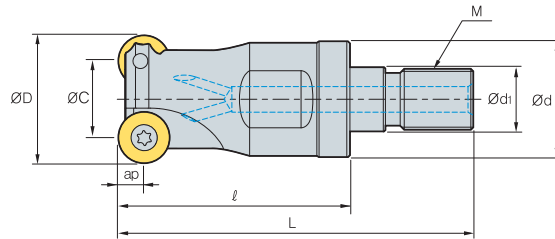
Parts

Specification		
Ø26 Ø33-Ø42	FTKA0408 FTKA0410	TW15S

Available inserts E17, E18 Available adaptor E401~E402



FMRM5000 new



• AR: -4°
• RR: 0°

(mm)

Designation		ØD	ØC	Ød	Ød ₁	ℓ	L	M	ap	
FMRM 5040HRP-M16	2	40	24	29	17	40	67	M16	8	0.21
5042HRP-M16	2	42	26	29	17	40	67	M16	8	0.23

Available inserts



Designation	Cermet		Coated										Uncoated		page		
	CN2500	CN30	NC5330	NCM325	NCM535	NCM545	PC2505	PC2510	PC3700	PC6510	PC9530	PC9540	PC5300	PC5400		ST30A	H01
RPCT 1606M0-MA																	
RPET 1606M0E-ML														●	●		
RPMT 1606M0E-MF														●	●		
1606M0S-MM							●	●	●				●	●			
RPMW 1606M0S1							●	●					●	●			

Available adaptor

Designation	Available adaptor
FMRM 5040HRP-M16	MAT-M16
5042HRP-M16	

Designation : FMRM5040HRP-M16
Modular head threading measure size (M16)

II

Adaptor spec.: MAT-M16-035-S32S
Adaptor threading measure (M16)

Parts

Specification			
Ø40~Ø42	FTGA0511-P	-	TW20-100

Available inserts E17, E18 Available adaptor E401~E402

E Technical Information for Triple Mill

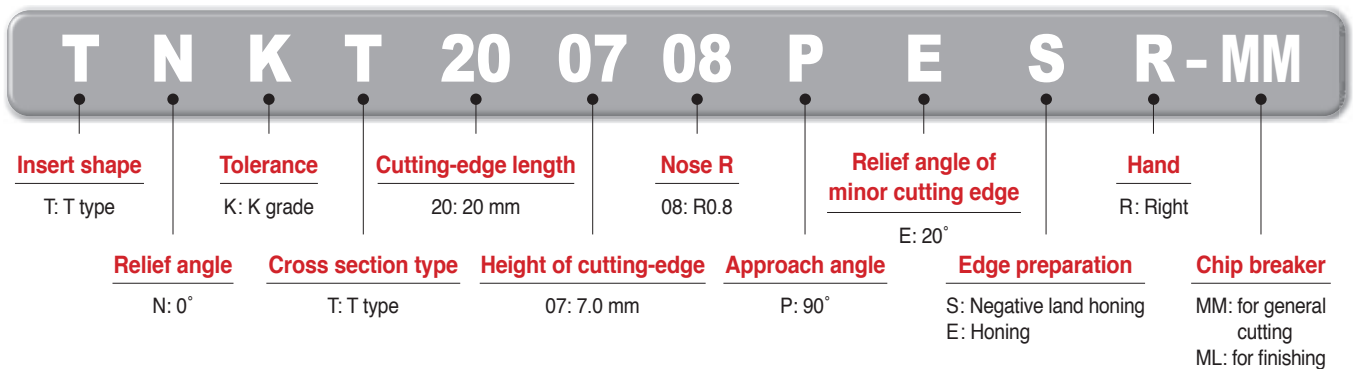
High depth of cut milling tool with 3 corners for perpendicularity

Triple Mill

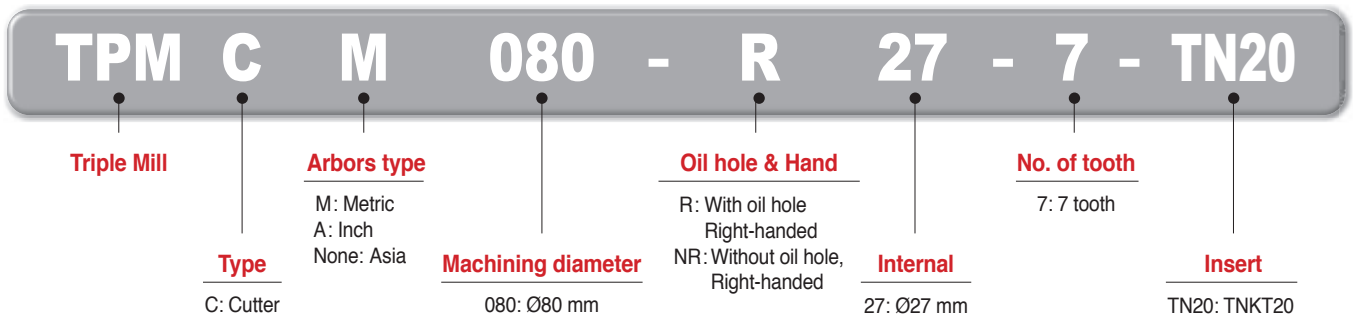
- Economical milling tool with 3 corners with positive cutting edge for high depth of cut machining
- Stable machinability in high feed machining due to enhanced chip evacuation and thicker insert
- High precision machining from less cutting load due to high helix and sharp cutting edge

Code system

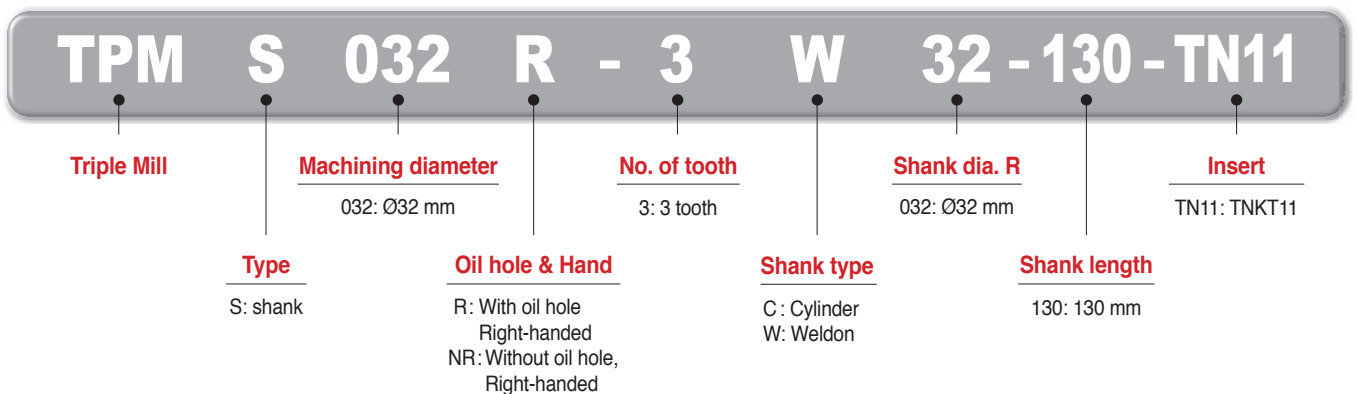
• Insert



• Cutter

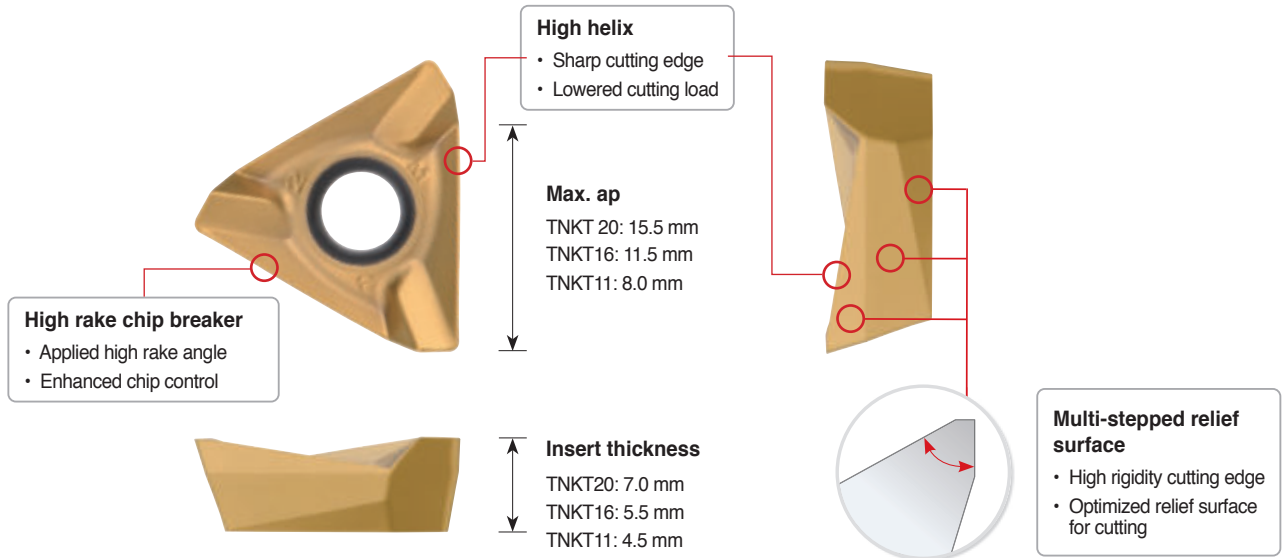


• Shank

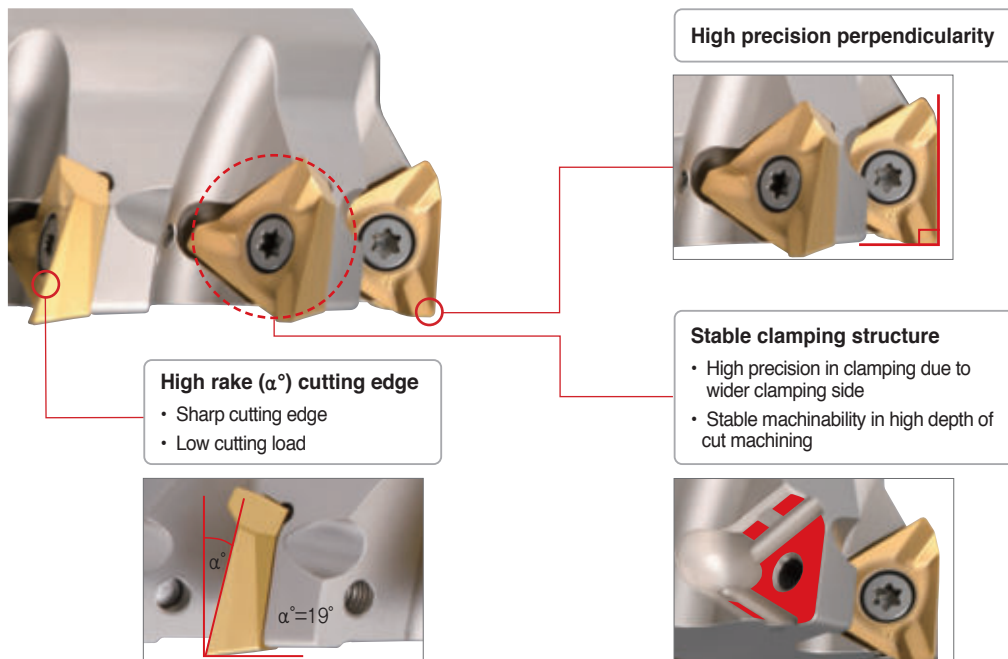


➤ Insert features

- Economical insert with 3 corners due to high depth of cut cutting edge
- Lowered cutting load and enhanced chip evacuation by sharp chip breaker and high helix cutting edge
- Stable machinability even in high cutting conditions from high rigidity design



➤ Cutter features



E Technical Information for Triple Mill

Recommended grade and chip breaker

(● : 1st Recommendation)

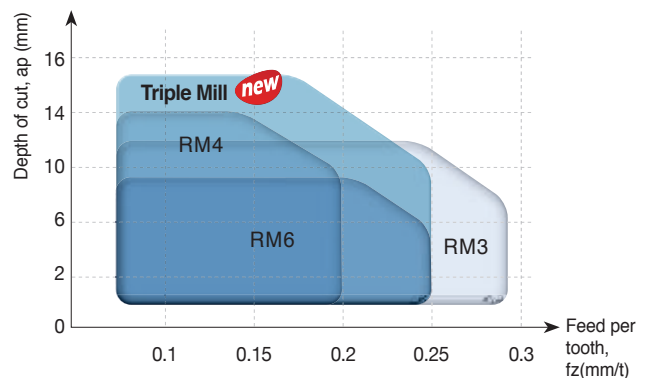
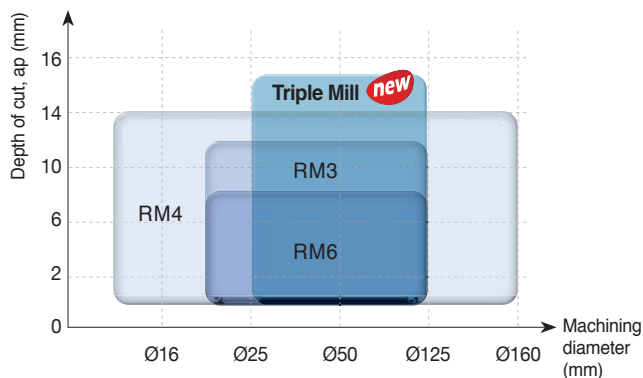
C/B	Cutting edge	P				M		K		S	
		Low carbon steel/ Mild steel		High carbon steel/ Alloy steel		Stainless steel		Cast iron		HRSA	
		C/B	Grade	C/B	Grade	C/B	Grade	C/B	Grade	C/B	Grade
ML		-	● PC3700 ○ PC5300 ○ PC5400	-	● PC3700 ○ PC5300 ○ PC5400	●	● PC5300 ○ PC5400 ○ PC9540	-	● PC6510 ○ PC5300 ○ PC5400	-	○ PC5300 ○ PC5400
MM		●	● PC3700 ○ PC5300 ○ PC5400	●	● PC3700 ○ PC5300 ○ PC5400	-	● PC5300 ○ PC5400 ○ PC9540	●	● PC6510 ○ PC5300 ○ PC5400	-	○ PC5300 ○ PC5400

Recommended cutting condition

Workpiece	Grade	Cutting speed vc(m/min)	TNKT11		TNKT16		TNKT20	
			fz (mm/t)	Max. ap (mm)	fz (mm/t)	Max. ap (mm)	fz (mm/t)	Max. ap (mm)
P Steel	PC3700	160-270	0.25-0.1	8.0	0.25-0.1	11.5	0.25-0.1	15.5
	PC5300	140-240	0.25-0.1	8.0	0.25-0.1	11.5	0.25-0.1	15.5
M Stainless steel	PC5300	90-150	0.2 - 0.05	8.0	0.2-0.05	11.5	0.2-0.05	15.5
	PC5400	70-120	0.2 - 0.05	8.0	0.2-0.05	11.5	0.2-0.05	15.5
	PC9540	70-120	0.2-0.05	8.0	0.2-0.05	11.5	0.2-0.05	15.5
K Cast iron	PC6510	150-250	0.3-0.1	8.0	0.3-0.10	11.5	0.3-0.1	15.5
S HRSA	PC5300	20-50	0.15-0.05	8.0	0.15-0.05	11.5	0.15-0.05	15.5

※ The above data refer to general cutting conditions and can be adjustable to the speed of 350 m/min and the feed per tooth of 0.3 mm/t depending on user environment.

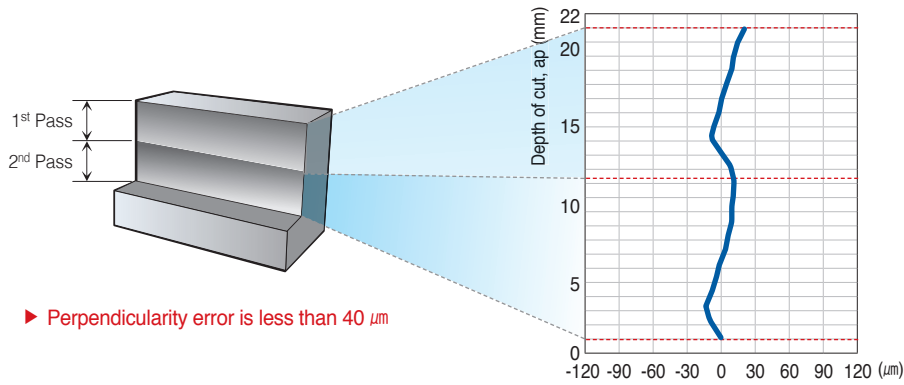
Application range



Performance evaluation

Perpendicularity

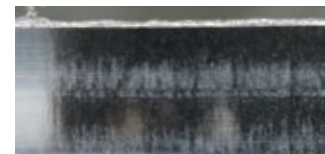
- Workpiece** Alloy steel (SCM440, HB200), 300(L) x 200(W) x 100(H)
- Cutting conditions** vc (m/min) = 200, fz (mm/t) = 0.2, ap (mm) = 12 mm x 2Passes (Total 24 mm), ae (mm) = 5, dry
- Tools** **Insert** TNKT200708PESR-MM (PC5300) **Holder** TPMCM080R-27-7-TN20



[Graph of measured perpendicularities]



Triple Mill

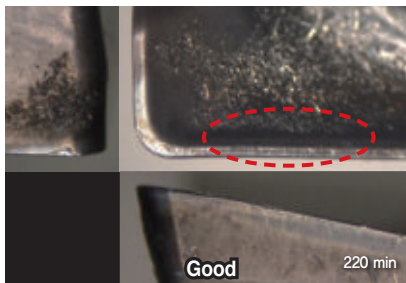


Competitor

[Comparison picture of flank surface finish]

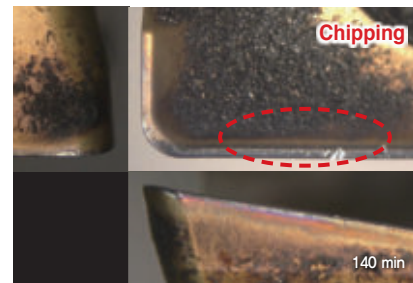
Wear resistance

- Workpiece** Alloy steel (SCM440, HB200), 300(L) x 200(W) x 100(H)
- Cutting conditions** vc (m/min) = 200, fz (mm/t) = 0.2, ap (mm) = 7, ae (mm) = 10, dry
- Tools** **Insert** TNKT160608PESR-MM (PC5300) **Holder** TPMCM063R-22-6-TN16



Triple Mill

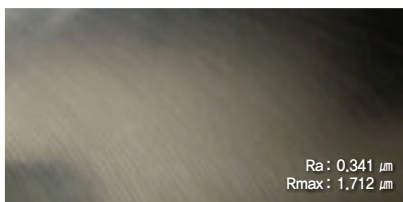
57% longer tool life



Competitor

Surface finish

- Workpiece** Alloy steel (SCM440, HB200), 300(L) x 200(W) x 100(H)
- Cutting conditions** vc (m/min) = 200, fz (mm/t) = 0.2, ap (mm) = 7, ae (mm) = 10, dry
- Tools** **Insert** TNKT160608PESR-MM (PC5300) **Holder** TPMCM063R-22-6-TN16



Triple Mill

Enhanced surface finish



Competitor

TPMCM-TN16 new

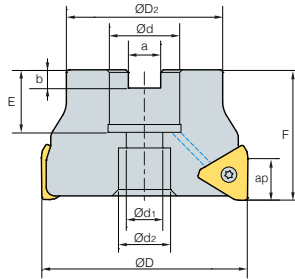


Fig. 1

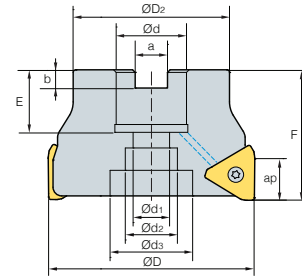


Fig. 2



AA
90°

• AR: 10°
• RR: -11°~-13.5°

(mm)

Designation		ØD	ØD2	Ød	Ød1	Ød2	Ød3	a	b	E	F	ap		Fig.	Available insert	
TPMCM	050R-22-4-TN16	4	50	42	22	11	18	-	10.4	6.3	21	40	11.5	0.26	1	TNKT16
	050R-22-5-TN16	5	50	42	22	11	18	-	10.4	6.3	21	40	11.5	0.26	1	
	063R-22-4-TN16	4	63	50	22	11	18	-	10.4	6.3	21	40	11.5	0.50	1	
	063R-22-6-TN16	6	63	50	22	11	18	-	10.4	6.3	21	40	11.5	0.48	1	
	080R-27-6-TN16	6	80	60	27	14	20	-	12.4	7	24	50	11.5	0.99	1	
	080R-27-8-TN16	8	80	60	27	14	20	-	12.4	7	24	50	11.5	0.99	1	
	100R-32-8-TN16	8	100	70	32	18	28	45	14.4	8	28	63	11.5	1.85	2	
	100R-32-10-TN16	10	100	70	32	18	28	45	14.4	8	28	63	11.5	1.83	2	
	125R-40-12-TN16	12	125	90	40	22	32	54	16.4	9	30	63	11.5	3.12	2	
125R-40-14-TN16	14	125	90	40	22	32	54	16.4	9	30	63	11.5	3.10	2		

Available inserts

TNKT-ML

TNKT-MM



Designation	Cermet		Coated										page			
	CN2500	CN30	NC5330	NCM325	NCM535	NCM545	PC2505	PC2010	PC2015	PC3700	PC6510	PC9530		PC9540	PC5300	PC5400
TNKT 160608PEER-ML										●				●		E28
160608PESR-MM										●	●			●		

Available arbors

Designation	Ød	NC arbors
TPMCM 050R-22-□-TN□□	22	BT□□-FMC22-□□
063R-22-□-TN□□		
080R-27-□-TN□□	27	BT□□-FMC27-□□
100R-32-□-TN□□	32	BT□□-FMC32-□□
125R-40-□-TN□□	40	BT□□-FMC40-□□

Parts

Specification		
Ø50~Ø125	FTKA0410	TW15S

Available inserts E28 Available arbors and bolt E426~E428



TPMCM-TN20 new

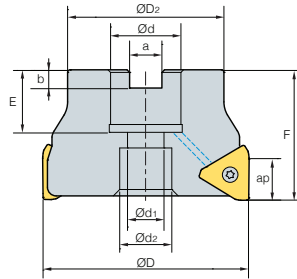


Fig. 1

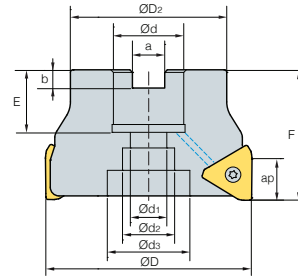


Fig. 2



AA **90°**
 • AR: 10°
 • RR: -10.5°~14°

Designation															(mm)	
		ØD	ØD ₂	Ød	Ød ₁	Ød ₂	Ød ₃	a	b	E	F	ap		Fig.	Available insert	
TPMCM	063R-22-5-TN20	5	63	50	22	11	18	-	10.4	6.3	21	50	15.5	0.57	1	TNKT20
	063R-22-6-TN20	6	63	50	22	11	18	-	10.4	6.3	21	50	15.5	0.58	1	
	080R-27-5-TN20	5	80	60	27	14	20	-	12.4	7	24	50	15.5	0.92	1	
	080R-27-7-TN20	7	80	60	27	14	20	-	12.4	7	24	50	15.5	0.86	1	
	100R-32-7-TN20	7	100	70	32	18	28	45	14.4	8	28	63	15.5	1.79	2	
	100R-32-9-TN20	9	100	70	32	18	28	45	14.4	8	28	63	15.5	1.68	2	
	125R-40-8-TN20	8	125	90	40	22	32	52	16.4	9	30	63	15.5	3.08	2	
	125R-40-11-TN20	11	125	90	40	22	32	52	16.4	9	30	63	15.5	2.99	2	

Available inserts

TNKT-ML TNKT-MM



Designation	Cermet		Coated											page		
	CN2500	CN30	NC5330	NCM325	NCM635	NCM645	PC2505	PC2010	PC2015	PC3700	PC6510	PC9530	PC9540		PC5300	PC5400
TNKT 200708PEER-ML										●			●	●		E28
200708PESR-MM										●	●			●		

Available arbors

Designation	Ød	NC arbors
TPMCM 063R-22-□-TN□□	22	BT□□-FMC22-□□
080R-27-□-TN□□	27	BT□□-FMC27-□□
100R-32-□-TN□□	32	BT□□-FMC32-□□
125R-40-□-TN□□	40	BT□□-FMC40-□□

Parts

Specification		
Ø63-Ø125	FTGA0511-P	TW20-100

Available inserts **E28** Available arbors and bolt **E426-E428**

TPMS-TN11 new

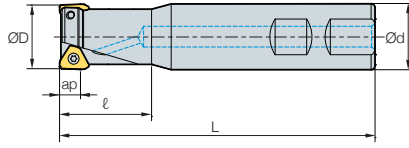


Fig. 1

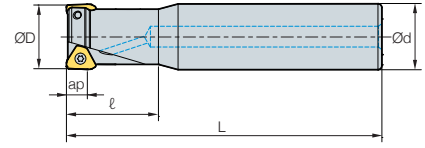


Fig. 2



AA
90°
• AR: 8°~10°
• RR: -14°~-15°

(mm)

Designation		ØD	Ød	ℓ	L	ap		Fig.	Available insert
TPMS	025R-2W25-120-TN11	2	25	25	35	120	8	0.37	1
	025R-2C25-200-TN11	2	25	25	35	200	8	0.65	2
	025R-3W25-120-TN11	3	25	25	35	120	8	0.36	1
	025R-3C25-200-TN11	3	25	25	35	200	8	0.64	2
	032R-2W32-130-TN11	2	32	32	40	130	8	0.71	1
	032R-2C32-200-TN11	2	32	32	40	200	8	1.12	2
	032R-3W32-130-TN11	3	32	32	40	130	8	0.70	1
	032R-3C32-200-TN11	3	32	32	40	200	8	1.14	2
	032R-4W32-130-TN11	4	32	32	40	130	8	0.70	1
	032R-4C32-200-TN11	4	32	32	40	200	8	1.11	2
	040R-4W40-130-TN11	4	40	40	40	130	8	1.12	1
	040R-5W40-130-TN11	5	40	40	40	130	8	1.11	1

TNKT11

Available inserts

TNKT-ML

TNKT-MM



Designation	Cermet		Coated											page		
	CN2500	CN30	NC5330	NCM325	NCM535	NCM545	PC2505	PC2010	PC2015	PC3700	PC6510	PC9530	PC9540		PC5300	PC5400
TNKT	110508PEER-ML									●			●	●		E28
	110508PESR-MM								●	●			●			

Parts

Specification		
Ø25~Ø40	FTKA0307	TW09S

Available inserts E28 Available arbors and bolt E426-E428



TPMS-TN16 new

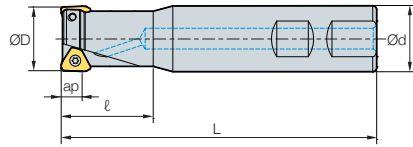


Fig. 1

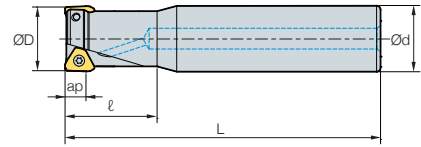


Fig. 2



										(mm)
Designation		ØD	Ød	ℓ	L	ap		Fig.	Available insert	
TPMS	032R-2W32-130-TN16	2	32	32	40	130	11.5	0.68	1	TNKT16
	032R-2C32-200-TN16	2	32	32	40	200	11.5	1.10	2	
	040R-3W40-130-TN16	3	40	40	40	130	11.5	1.09	1	
	040R-3C40-200-TN16	3	40	40	40	200	11.5	1.75	2	
	040R-4W40-130-TN16	4	40	40	40	130	11.5	1.08	1	

Available inserts

TNKT-ML TNKT-MM



Designation	Cermet		Coated										page			
	CN2500	CN30	NC5330	NCM325	NCM535	NCM545	PC2505	PC2010	PC2015	PC3700	PC6510	PC9530		PC9540	PC5300	PC5400
TNKT 160608PEER-ML										●				●		E28
160608PESR-MM									●	●				●		

Parts

Specification		
Ø32~Ø40	FTKA0410	TW15S

Available inserts **E28** Available arbors and bolt **E426~E428**

E Technical Information for HFMD

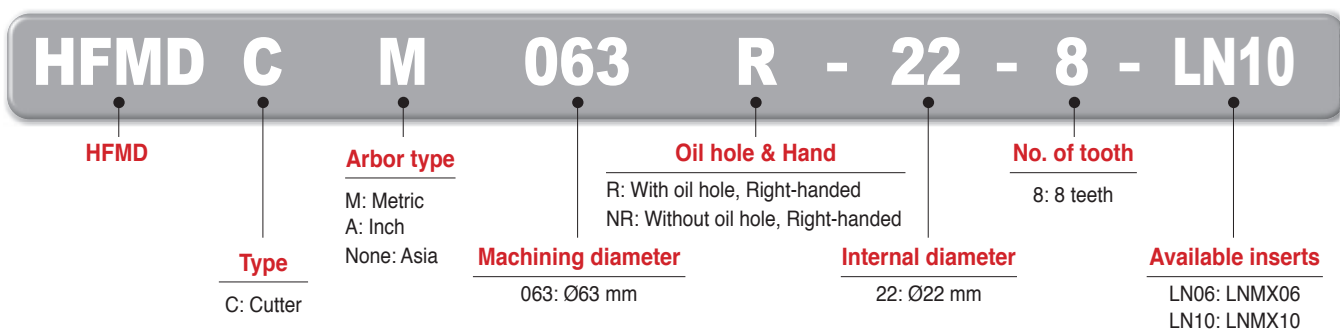
High Feed Milling Tool with 4 Corners for Small Diameter

HFMD new

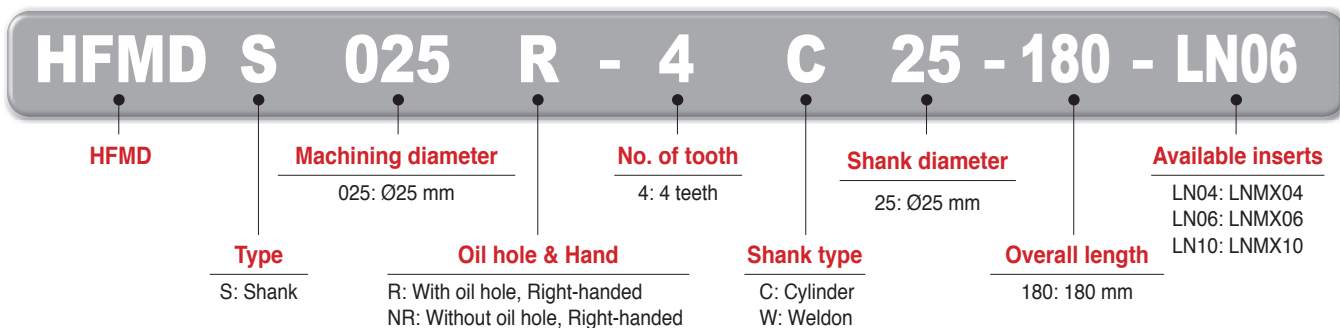
- Economical 4-corner double sided insert
- Increased productivity due to thinner and elongated shape of the insert which makes fine pitch available
- Insert designed for low cutting resistance with high rake angle and helix angle which reduces cutting load
- Inhibiting chipping and breakage due to concave clamping system and stronger screw

Code system

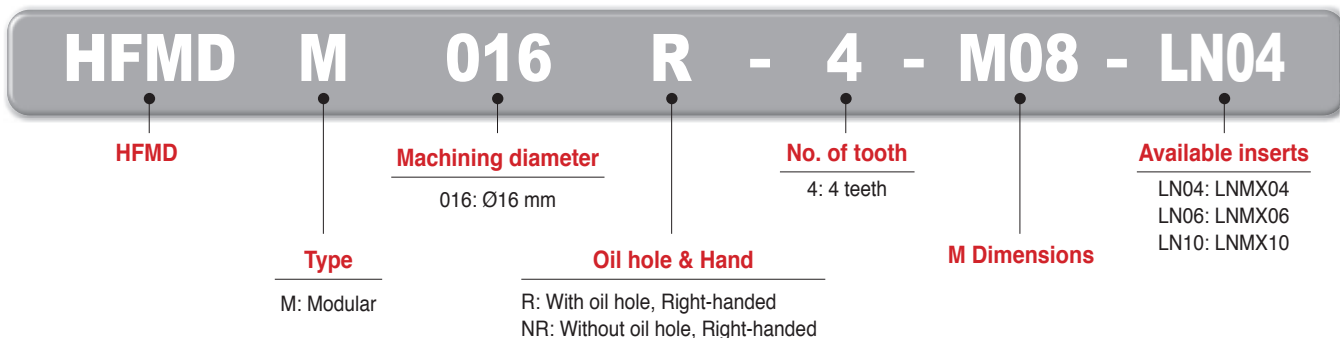
• Cutter



• Shank



• Modular



Features

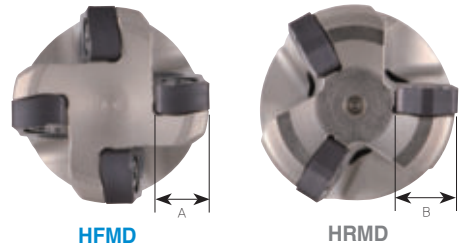
Economical 4-corner insert

- Can use 4 corners with 1 insert by utilizing front/back face; High feed due to finer pitch



Highly efficient insert due to fine pitch

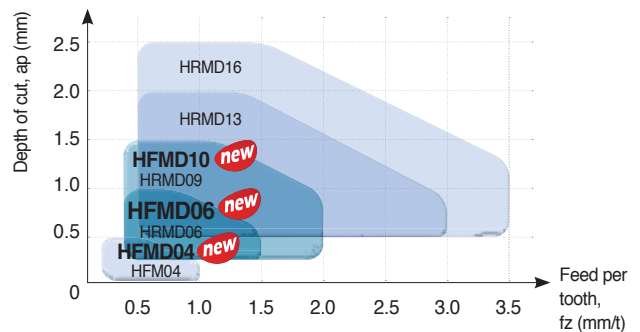
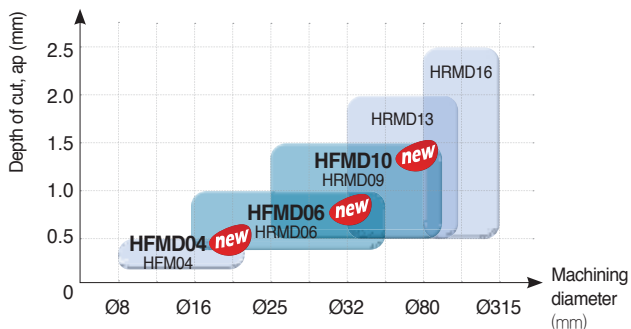
- Able to use fine pitch at the same machining diameter with typical types of milling cutters due to smaller inscribed circle ($A < B$)



Features of chip breaker

Insert	Cutting-edge	Uses	Features
ML		For heat resistant alloy and titanium	Ensures superior machining quality by applying a low cutting resistance chip breaker and high-strength cutting edge design suitable for machining heat resistant alloy
MF		For light cutting	Suitable for light cutting with a low cutting resistance chip breaker design
MM		For multi-purpose	Available for most cutting area with its exclusive design suitable for general high feed machining

Application area



Recommended cutting condition

※ Recommended chip breaker: ● 1st ○ 2nd



ISO	Workpiece			Grade	vc (m/min)	LNMx04		LNMx06		LNMx10		ae	Available chip breaker			
	Workpiece materials	KS	HB (H _R C)			fz (mm/t)	ap (mm)	fz (mm/t)	ap (mm)	fz (mm/t)	ap (mm)		ML	MF	MM	
P	Mild steel	SM20C	120 - 180	PC5400 (PC5300)	100-240	1.2-0.3	0.2-0.5	1.2-0.3	0.2-1.0	1.4-0.3	0.3-1.5	0.7D-0.1D	○	●		
	Carbon steel	SM45C	200	PC5400 (PC5300)	100-240	1.2-0.3	0.2-0.5	1.2-0.3	0.2-1.0	1.4-0.3	0.3-1.5	0.7D-0.1D	○	●		
	Alloy steel	SCM440	270 (28)	PC3700 (PC5300)	100-220	1.2-0.3	0.2-0.5	1.2-0.3	0.2-1.0	1.4-0.3	0.3-1.5	0.7D-0.1D		●	○	
	Pre-hardened steel	KP4M	300 (32)	PC3700 (PC5300)	100-200	1.0-0.3	0.2-0.4	1.0-0.3	0.2-0.8	1.2-0.3	0.3-1.2	0.7D-0.1D		○	●	
		NIMAX	370 (40)	PC3700 (PC5300)	100-200	1.0-0.3	0.2-0.4	1.0-0.3	0.2-0.8	1.2-0.3	0.3-1.2	0.7D-0.1D		○	●	
		CENA1	370 (40)	PC3700 (PC5300)	100-200	1.0-0.3	0.2-0.4	1.0-0.3	0.2-0.8	1.2-0.3	0.3-1.2	0.7D-0.1D		○	●	
		NAK80	400 (43)	PC5300 (PC3700)	100-200	1.0-0.3	0.2-0.4	1.0-0.3	0.2-0.8	1.2-0.3	0.3-1.2	0.7D-0.1D		○	●	
STAVAX	510 (52)	PC3700 (PC2510)	80-160	0.7-0.3	0.2-0.4	0.7-0.3	0.2-0.8	0.9-0.3	0.3-1.2	0.7D-0.1D		○	●			
Alloy tool steel	STD11 STD61	- (40-50)	PC2510 (PC5300)	80-130	0.7-0.3	0.2-0.3	0.65-0.3	0.2-0.6	0.8-0.3	0.3-0.9	0.7D-0.1D		○	●		
M	Stainless steel	STS316	Under 270	PC9540 (PC5400)	90-180	0.8-0.3	0.2-0.5	0.8-0.3	0.2-0.8	1.0-0.3	0.3-1.2	0.7D-0.1D	●	○		
K	Grey cast iron, Ductile cast iron	GCD450	Tensile Strength Over 450Mpa	PC5300 (PC5400)	130-220	0.9-0.3	0.2-0.5	0.9-0.3	0.2-1.0	1.2-0.3	0.3-1.5	0.7D-0.1D		●	○	
S	HRSA	Fe series	Incoroy901	- (25-35)	PC9540 (PC5300)	30-100	0.7-0.3	0.2-0.3	0.6-0.3	0.2-0.6	0.7-0.3	0.3-0.9	0.7D-0.4D	●	○	
		Ni or Co series	Inconel718	- (35-45)	PC9540 (PC5300)	30-45	0.7-0.3	0.2-0.3	0.7-0.3	0.2-0.6	0.8-0.3	0.3-0.9	0.7D-0.4D	○	●	
	Titanium	Ti-6AL-4V	- (40-45)	PC9540 (PC5300)	30-50	0.8-0.3	0.2-0.3	1.0-0.3	0.2-0.6	1.2-0.3	0.3-0.9	0.7D-0.1D	●	○		

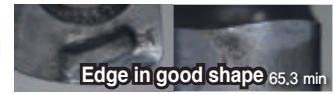
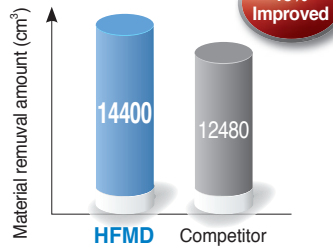


Performance evaluation

Carbon steel (SM45C, HB200)

- **Workpiece** Steel rectangular tube (300 × 200 × 100)
- **Cutting conditions** vc (m/min) = 200, fz (mm/t) = 1.2, ap (mm) = 0.8, ae (mm) = 20, dry
- **Tools** **Insert** LNMX060310R-MF (PC5300)
Holder HFMD S032R-5C32-200-LN06

Test result



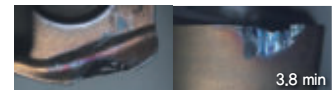
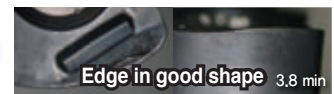
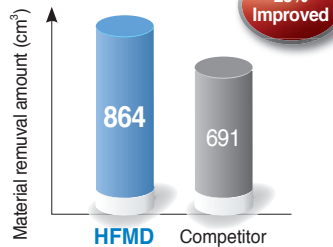
Competitor

- Material removal rate Q (cm³/min): 191.0
- Cutting time (min): 75.4

Pre-hardened steel (KP4M, HRC30)

- **Workpiece** Steel rectangular tube (300 × 200 × 100)
- **Cutting conditions** vc (m/min) = 160, fz (mm/t) = 1.2, ap (mm) = 1.2, ae (mm) = 20, dry
- **Tools** **Insert** LNMX100412R-MF (PC5300)
Holder HFMD S032R-4C32-200-LN10

Test result



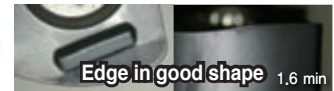
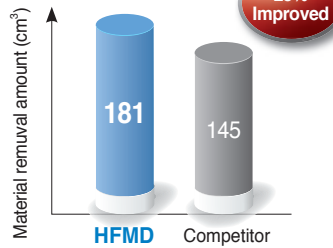
Competitor

- Material removal rate Q (cm³/min): 183.3
- Cutting time (min): 4.7

Alloy tool steel (STD11, HRC40-45)

- **Workpiece** Steel rectangular tube (300 × 200 × 100)
- **Cutting conditions** vc (m/min) = 160, fz (mm/t) = 1.2, ap (mm) = 0.9, ae (mm) = 20, dry
- **Tools** **Insert** LNMX100412R-MF (PC2510)
Holder HFMD S032R-4C32-200-LN10

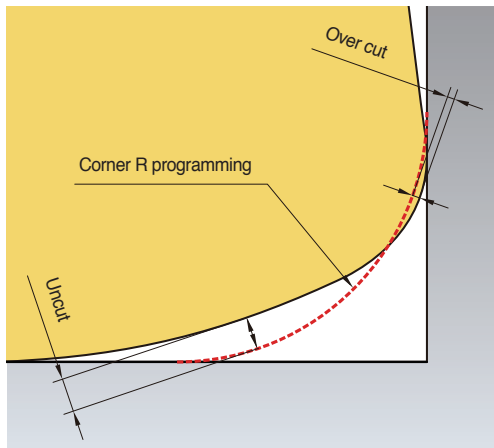
Test result



Competitor

- Material removal rate Q (cm³/min): 91.7
- Cutting time (min): 2.0

Corner R programming

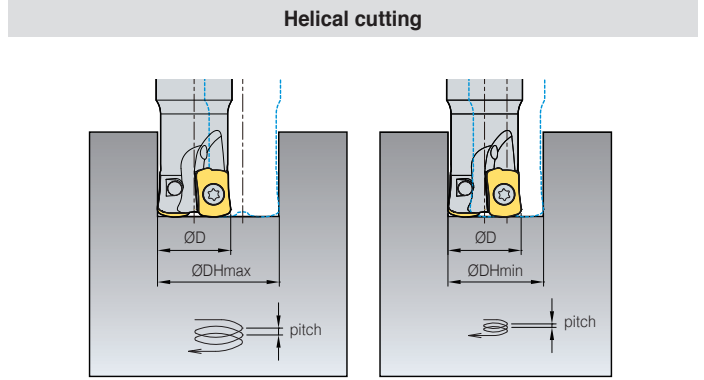
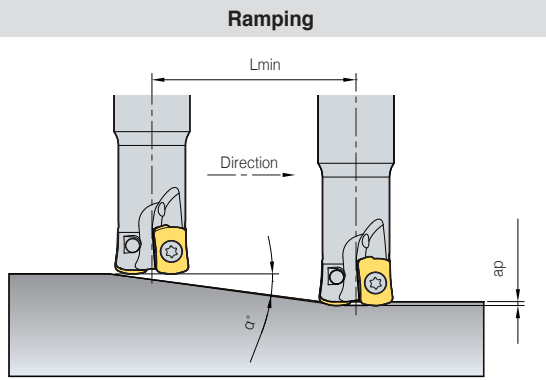


----- Corner R programming

Insert	Corner R programming	Cutting conditions		Over Cut	Uncut
		Nose R	Max. ap		
LNMX040205R-ML LNMX040205R-MM	R0.8	0.5	0.5	0	0.27
	R0.9(Standard)			0	0.24
	R1.0			0.01	0.22
LNMX060310R-ML LNMX060310R-MF LNMX060310R-MM	R1.5	1.0	1.0	0	0.41
	R1.6(Standard)			0	0.41
	R2.0			0.06	0.38
LNMX100412R-ML LNMX100412R-MF LNMX100412R-MM	R2.0	1.2	1.5	0	0.84
	R2.5(Standard)			0	0.60
	R3.0			0.06	0.51

- During usage of CNC program, over cut & uncut would be occurred on the corner processing site if entering the correct program corner R value for each insert
- To prevent overcut, you will need to complete a CNC program considering the above overcut

Ramping and helical cutting



(mm)

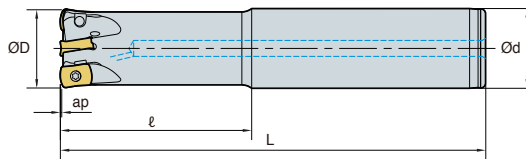
Designation	Tool dia. ØD	Depth of cut ap	Ramping		Blind hole helical cutting				Thru hole helical cutting		
			Max ramping angle α (°)	Lmin	Max diameter ØDHmax	Max pitch	Min diameter ØDHmin	Max pitch	Min diameter ØDHmin	Max pitch	
LNMx04	8	0.4	0.5	45	12	0.2	10	0.2	9	0.2	
	10		0.6	37	16	0.3	14	0.3	13	0.3	
	11		0.8	37	18	0.3	15	0.3	15	0.3	
	12		1.0	28	20	0.4	17	0.4	17	0.4	
	13		1.0	27	22	0.4	19	0.4	19	0.4	
	16	0.5	1.0	28	28	0.5	25	0.5	25	0.5	
	17		1.0	29	30	0.5	27	0.5	27	0.5	
	20		0.9	33	36	0.5	33	0.5	33	0.5	
	21		0.7	44	38	0.5	35	0.5	35	0.5	
	25		0.7	43	46	0.5	43	0.5	43	0.5	
	32		0.5	57	60	0.5	57	0.5	57	0.5	
LNMx06	33	1.0	0.4	74	62	0.5	59	0.5	59	0.5	
	35		0.4	79	66	0.5	63	0.5	63	0.5	
	16		0.7	3.0	13	30	0.7	22	0.7	21	0.7
	17			2.3	25	32	1.0	24	1.0	22	1.0
	18		1.0	2.1	27	34	1.0	26	1.0	24	1.0
	19			1.9	30	36	1.0	28	1.0	26	1.0
	20			1.5	37	38	1.0	30	1.0	28	1.0
	21			1.5	39	40	1.0	32	1.0	30	1.0
	25			1.4	40	48	1.0	40	1.0	38	1.0
	26			1.4	42	50	1.0	42	1.0	40	1.0
	30			1.1	51	58	1.0	50	1.0	48	1.0
	32			1.0	55	62	1.0	54	1.0	52	1.0
	33			1.0	57	64	1.0	56	1.0	54	1.0
	35			0.9	61	68	1.0	60	1.0	58	1.0
40	0.8	71		78	1.0	70	1.0	68	1.0		
42	0.8	76		82	1.0	74	1.0	72	1.0		
LNMx10	50	1.5	0.6	92	98	1.0	90	1.0	88	1.0	
	52		0.6	96	102	1.0	94	1.0	92	1.0	
	63		0.5	119	124	1.0	116	1.0	114	1.0	
	66		0.5	126	130	1.0	122	1.0	120	1.0	
	25		1.5	2.9	30	42	1.5	35	1.5	32	1.5
	26			2.7	32	44	1.5	37	1.5	34	1.5
	30			2.2	39	52	1.5	45	1.5	42	1.5
	32			2.0	43	56	1.5	49	1.5	46	1.5
	33			1.9	45	58	1.5	51	1.5	48	1.5
	35			1.8	49	62	1.5	55	1.5	52	1.5
	40			1.5	58	72	1.5	65	1.5	62	1.5
	42			1.4	62	76	1.5	69	1.5	66	1.5
	50			1.1	77	92	1.5	85	1.5	82	1.5
52	1.1	81		96	1.5	89	1.5	86	1.5		
63	0.8	101		118	1.5	111	1.5	108	1.5		
66	0.8	107		124	1.5	117	1.5	114	1.5		
80	0.6	133	152	1.5	145	1.5	142	1.5			
100	0.5	171	192	1.5	185	1.5	182	1.5			

- When ramping and helical milling, table feed, vf (mm/min) should be lower than 70% of the recommended cutting conditions.
- When helical milling, Max. pitch, DHmax should be lower than max. depth of cut, ap.
- When ramping, the depth of cut should be lower than max. depth of cut, ap.

- $L_{min} = ap / \tan(\alpha)$ (mm)
- Lmin: Min. length of ramping
- ap: Depth of cut
- α : Max. rake angle in ramping



HFMDs-LN04 new



Designation		ØD	Ød	l	L	ap	
HFMDS 008NR-1C08-080-LN04	1	8	8	20	80	0.4	0.03
008NR-1C10-100-LN04	1	8	10	20	100	0.4	0.05
010NR-2C08-080-LN04	2	10	8	20	80	0.4	0.03
010NR-2C10-100-LN04	2	10	10	20	100	0.4	0.06
010NR-2C10-150-LN04	2	10	10	40	150	0.4	0.08
011NR-2C10-100-LN04	2	11	10	20	100	0.5	0.06
011NR-2C10-150-LN04	2	11	10	20	150	0.5	0.09
008R-1C08-080-LN04	1	8	8	20	80	0.5	0.02
008R-1C10-100-LN04	1	8	10	20	100	0.5	0.05
010R-2C08-080-LN04	2	10	8	20	80	0.4	0.03
010R-2C10-080-LN04	2	10	10	35	80	0.4	0.05
010R-2C10-100-LN04	2	10	10	20	100	0.4	0.05
010R-2C10-150-LN04	2	10	10	40	150	0.4	0.07
011R-2C10-100-LN04	2	11	10	20	100	0.5	0.05
011R-2C10-150-LN04	2	11	10	20	150	0.5	0.08
012R-3C12-100-LN04	3	12	12	50	100	0.5	0.07
012R-3C12-105-LN04	3	12	12	20	105	0.5	0.07
012R-3C12-150-LN04	3	12	12	40	150	0.5	0.11

Available inserts

LNMX-ML LNMX-MM



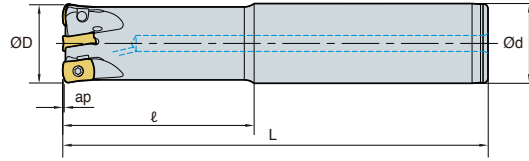
Designation	Cermet		Coated										Uncoated		page			
	CN2500	CN30	NC5330	NCM325	NCM335	NCM535	NCM545	PC2505	PC2510	PC3700	PC6510	PC9530	PC9540	PC5300		PC5400	ST30A	H01
LNMX 040205R-ML														●	●			E12
040205R-MM								●	●					●	●			

Parts

Specification		
Ø8~Ø12	FTKA01844-A	TW06S-A

Available inserts E12

HFMDs-LN04 new



• AR: -8°
• RR: -14°~13°

(mm)

Designation		ØD	Ød	ℓ	L	ap	
HFMDS 013R-3C12-100-LN04	3	13	12	20	100	0.5	0.08
013R-3C12-120-LN04	3	13	12	20	120	0.5	0.09
013R-3C12-150-LN04	3	13	12	20	150	0.5	0.12
016R-4C16-100-LN04	4	16	16	50	100	0.5	0.13
016R-4C16-120-LN04	4	16	16	70	120	0.5	0.20
016R-4C16-150-LN04	4	16	16	80	150	0.5	0.20
016R-4C16-200-LN04	4	16	16	120	200	0.5	0.26
017R-4C16-100-LN04	4	17	16	20	100	0.5	0.14
017R-4C16-150-LN04	4	17	16	20	150	0.5	0.20
017R-4C16-200-LN04	4	17	16	20	200	0.5	0.29
020R-5C20-100-LN04	5	20	20	20	100	0.5	0.22
020R-5C20-150-LN04	5	20	20	40	150	0.5	0.30
020R-5C20-200-LN04	5	20	20	80	200	0.5	0.40
021R-5C20-100-LN04	5	21	20	20	100	0.5	0.22
021R-5C20-150-LN04	5	21	20	20	150	0.5	0.30
021R-5C20-200-LN04	5	21	20	20	200	0.5	0.46

Available inserts

LNMX-ML LNMX-MM



Designation	Cermet		Coated										Uncoated		page			
	CN2500	CN30	NC5330	NCM325	NCM335	NCM535	NCM545	PC2505	PC2510	PC3700	PC6510	PC9530	PC9540	PC5300		PC5400	ST30A	H01
LNMX 040205R-ML														●	●			E12
040205R-MM								●	●					●	●			

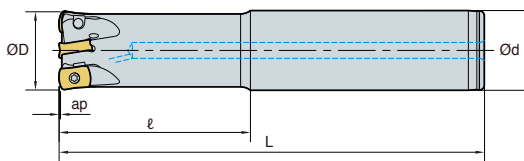
Parts

Specification		
Ø13~Ø21	FTKA01844-A	TW06S-A

Available inserts E12



HFMD S-LN06 new



(mm)

Designation		ØD	Ød	l	L	ap	
HFMD S 016R-2C16-100-LN06	2	16	16	30	100	0.7	0.13
016R-2C16-150-LN06	2	16	16	50	150	0.7	0.19
017R-2C16-100-LN06	2	17	16	30	100	1.0	0.13
017R-2C16-150-LN06	2	17	16	40	150	1.0	0.20
017R-2C16-200-LN06	2	17	16	40	200	1.0	0.27
018R-2C16-100-LN06	2	18	16	40	100	1.0	0.14
018R-2C16-160-LN06	2	18	16	40	160	1.0	0.18
018R-2C16-200-LN06	2	18	16	40	200	1.0	0.28
019R-2C16-100-LN06	2	19	16	40	100	1.0	0.15
019R-2C16-160-LN06	2	19	16	40	160	1.0	0.19
019R-2C16-200-LN06	2	19	16	40	200	1.0	0.29
020R-3C20-100-LN06	3	20	20	40	100	1.0	0.20
020R-3C20-130-LN06	3	20	20	50	130	1.0	0.26
020R-3C20-160-LN06	3	20	20	80	160	1.0	0.31
020R-3C20-200-LN06	3	20	20	120	200	1.0	0.40
021R-3C20-100-LN06	3	21	20	30	100	1.0	0.21
021R-3C20-130-LN06	3	21	20	40	130	1.0	0.27
021R-3C20-160-LN06	3	21	20	40	160	1.0	0.34
021R-3C20-200-LN06	3	21	20	40	200	1.0	0.42

Available inserts

LNMX-ML LNMX-MF LNMX-MM



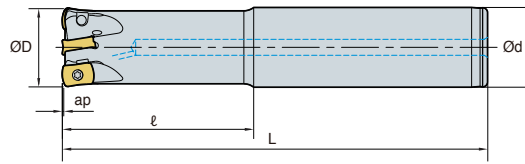
Designation	Cermet		Coated										Uncoated		page			
	CN2500	CN30	NC5330	NCM325	NCM335	NCM535	NCM545	PC2505	PC2510	PC3700	PC6510	PC9530	PC9540	PC5300		PC5400	ST30A	H01
LNMX 060310R-ML									●	●				●	●			E12
060310R-MF								●	●					●	●			
060310R-MM								●	●					●	●			

Parts

Specification		
Ø16~Ø21	FTNA0306	TW09S

Available inserts E12

HFMD S-LN06 new



• AR: -9°
• RR: -12°~10°

(mm)

Designation		ØD	Ød	ℓ	L	ap	
HFMD S 025R-4C25-100-LN06	4	25	25	40	100	1.0	0.33
025R-4C25-140-LN06	4	25	25	60	140	1.0	0.46
025R-4C25-180-LN06	4	25	25	100	180	1.0	0.58
025R-4C25-250-LN06	4	25	25	150	250	1.0	0.67
026R-4C25-100-LN06	4	26	25	30	100	1.0	0.34
026R-4C25-140-LN06	4	26	25	40	140	1.0	0.48
026R-4C25-180-LN06	4	26	25	40	180	1.0	0.63
026R-4C25-250-LN06	4	26	25	40	250	1.0	0.72
032R-5C32-150-LN06	5	32	32	70	150	1.0	0.82
032R-5C32-200-LN06	5	32	32	120	200	1.0	1.08
032R-5C32-250-LN06	5	32	32	150	250	1.0	1.20
033R-5C32-150-LN06	5	33	32	40	150	1.0	0.82
033R-5C32-200-LN06	5	33	32	40	200	1.0	1.08
033R-5C32-250-LN06	5	33	32	40	250	1.0	1.20
035R-5C32-150-LN06	5	35	32	40	150	1.0	0.87
035R-5C32-200-LN06	5	35	32	40	200	1.0	1.13
035R-5C32-250-LN06	5	35	32	40	250	1.0	1.25
040R-6C32-150-LN06	6	40	32	40	150	1.0	0.97
040R-6C32-200-LN06	6	40	32	40	200	1.0	1.28
040R-6C32-250-LN06	6	40	32	40	250	1.0	1.38

Available inserts

LNX-ML LNX-MF LNX-MM



Designation	Cermet		Coated												Uncoated		page	
	CN2500	CN30	NC5330	NCM325	NCM335	NCM535	NCM545	PC2505	PC2510	PC3700	PC6510	PC9530	PC9540	PC5300	PC5400	ST30A		H01
LNX 060310R-ML															●	●		
060310R-MF								●	●						●	●		
060310R-MM								●	●						●	●		

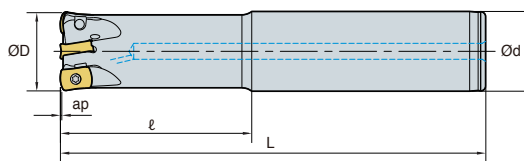
Parts

Specification		
Ø25-Ø40	FTNA0306	TW09S

Available inserts E12



HFMD S-LN10 new



• AR: -9°
• RR: -16°~13°

(mm)

Designation		ØD	Ød	l	L	ap	
HFMD S 025R-2C25-150-LN10	2	25	25	70	150	1.5	0.46
025R-2C25-200-LN10	2	25	25	100	200	1.5	0.60
025R-3C25-150-LN10	3	25	25	70	150	1.5	0.45
025R-3C25-200-LN10	3	25	25	100	200	1.5	0.60
026R-3C25-150-LN10	3	26	25	40	150	1.5	0.49
026R-3C25-200-LN10	3	26	25	40	200	1.5	0.68
030R-3C32-150-LN10	3	30	32	70	150	1.5	0.71
030R-3C32-200-LN10	3	30	32	100	200	1.5	0.94
032R-4C32-150-LN10	4	32	32	70	150	1.5	0.75
032R-4C32-200-LN10	4	32	32	100	200	1.5	1.00
032R-4C32-250-LN10	4	32	32	150	250	1.5	1.20
033R-4C32-150-LN10	4	33	32	40	150	1.5	0.80
033R-4C32-200-LN10	4	33	32	40	200	1.5	1.00
033R-4C32-250-LN10	4	33	32	40	250	1.5	1.40
035R-4C32-150-LN10	4	35	32	40	150	1.5	0.85
035R-4C32-200-LN10	4	35	32	40	200	1.5	1.10
035R-4C32-250-LN10	4	35	32	40	250	1.5	1.44
040R-4C32-150-LN10	4	40	32	40	150	1.5	0.89
040R-4C32-200-LN10	4	40	32	40	200	1.5	1.20
040R-4C32-250-LN10	4	40	32	40	250	1.5	1.48
040R-5C32-150-LN10	5	40	32	40	150	1.5	0.89
040R-5C32-200-LN10	5	40	32	40	200	1.5	1.19
040R-5C32-250-LN10	5	40	32	40	250	1.5	1.48
042R-5C32-150-LN10	5	42	32	40	150	1.5	0.92
042R-5C32-200-LN10	5	42	32	40	200	1.5	1.23
042R-5C32-250-LN10	5	42	32	40	250	1.5	1.51

Available inserts

LNMX-ML LNMX-MF LNMX-MM



Designation	Cermet		Coated										Uncoated		page			
	CN2500	CN30	NC5330	NCM325	NCM335	NCM535	NCM545	PC2505	PC2510	PC3700	PC6510	PC9530	PC9540	PC5300		PC5400	ST30A	H01
LNMX 100412R-ML													●	●	●			E12
100412R-MF								●	●				●	●	●			
100412R-MM								●	●				●	●				

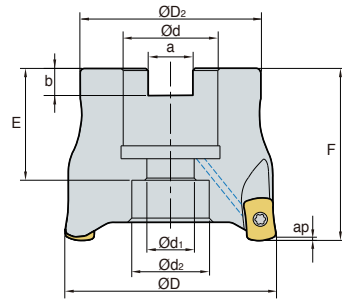
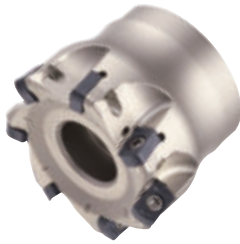
Parts

Specification		
Ø25~Ø42	FTNA0408	TW15S

Available inserts E12



HFMDCM-LN06 new



• AR: -9°
• RR: -12°~-10°

(mm)

Designation		ØD	ØD ₂	Ød	Ød ₁	Ød ₂	a	b	E	F	ap	
HFMDCM 032R-16-5-LN06	5	32	30	16	9	13.5	8.4	5.6	19	40	1.0	0.12
040R-16-6-LN06	6	40	34	16	9	14	8.4	5.6	19	40	1.0	0.21
050R-22-6-LN06	6	50	42	22	11	18	10.4	6.3	21	40	1.0	0.32
050R-22-7-LN06	7	50	42	22	11	18	10.4	6.3	21	40	1.0	0.32
050R-22-8-LN06	8	50	42	22	11	18	10.4	6.3	21	40	1.0	0.32
052R-22-7-LN06	7	52	42	22	11	18	10.4	6.3	21	40	1.0	0.34
052R-22-8-LN06	8	52	42	22	11	18	10.4	6.3	21	40	1.0	0.34
063R-22-8-LN06	8	63	49	22	11	18	10.4	6.3	21	40	1.0	0.53
063R-22-9-LN06	9	63	49	22	11	18	10.4	6.3	21	40	1.0	0.53
066R-22-8-LN06	8	66	49	22	11	18	10.4	6.3	21	40	1.0	0.57
066R-22-9-LN06	9	66	49	22	11	18	10.4	6.3	21	40	1.0	0.57

Available inserts

LNMX-ML LNMX-MF LNMX-MM



Designation	Cermet		Coated										Uncoated		page			
	CN2500	CN30	NC5330	NCM325	NCM335	NCM535	NCM545	PC2505	PC2510	PC3700	PC6510	PC9530	PC9540	PC5300		PC5400	ST30A	H01
LNMX 060310R-ML																		E12
060310R-MF								●	●					●	●			
060310R-MM								●	●					●	●			

Available arbors

Designation	Ød	Available arbors
HFMDCM 032R-16-□-LN06	Ø32	BT□□-FMC16-□□
040R-16-□-LN06	Ø40	
050R-22-□-LN06	Ø50	

Designation	Ød	Available arbors
HFMDCM 052R-22-□-LN06	Ø52	BT□□-FMC22-□□
063R-22-□-LN06	Ø63	
066R-22-□-LN06	Ø66	

Parts

Specification		
Ø32~Ø66	FTNA0306	TW09S

Available inserts E12 Available arbors and bolt E426-E428



HFMDC(M)-LN10 new

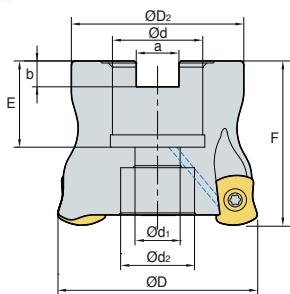


Fig. 1

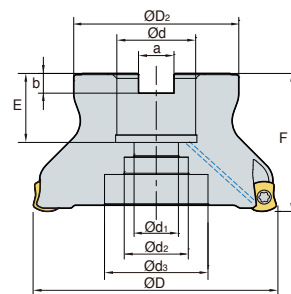


Fig. 2



• AR: -9°
• RR: -16°~13°

(mm)

Designation	ØD	ØD2	Ød	Ød1	Ød2	Ød3	a	b	E	F	ap	kg	Fig.	
HFMDCM 040R-16-4-LN10	4	40	38	16	9	14	-	8.4	5.6	19	40	1.5	0.19	1
040R-16-5-LN10	5	40	38	16	9	14	-	8.4	5.6	19	40	1.5	0.19	1
042R-16-4-LN10	4	42	38	16	9	14	-	8.4	5.6	19	40	1.5	0.20	1
042R-16-5-LN10	5	42	38	16	9	14	-	8.4	5.6	19	40	1.5	0.20	1
050R-22-6-LN10	6	50	42	22	11	18	-	10.4	6.3	21	40	1.5	0.26	1
050R-22-7-LN10	7	50	42	22	11	18	-	10.4	6.3	21	40	1.5	0.26	1
052R-22-6-LN10	6	52	42	22	11	18	-	10.4	6.3	21	40	1.5	0.27	1
052R-22-7-LN10	7	52	42	22	11	18	-	10.4	6.3	21	40	1.5	0.27	1
063R-22-7-LN10	7	63	49	22	11	18	-	10.4	6.3	21	40	1.5	0.47	1
063R-22-8-LN10	8	63	49	22	11	18	-	10.4	6.3	21	40	1.5	0.47	1
066R-22-7-LN10	7	66	49	22	11	18	-	10.4	6.3	21	40	1.5	0.49	1
066R-22-8-LN10	8	66	49	22	11	18	-	10.4	6.3	21	40	1.5	0.50	1
080R-27-9-LN10	9	80	60	27	14	25	35	12.4	7.0	24	50	1.5	0.84	2
080R-27-10-LN10	10	80	60	27	14	25	35	12.4	7.0	24	50	1.5	0.84	2
100R-32-10-LN10	10	100	67	32	18	26	42	14.4	8.0	28	56	1.5	1.48	2
100R-32-11-LN10	11	100	67	32	18	26	42	14.4	8.0	28	56	1.5	1.48	2
100R-32-12-LN10	12	100	67	32	18	26	42	14.4	8.0	28	56	1.5	1.48	2
HFMDC 080R-25.4-9-LN10	9	80	60	25.4	14	25	35	9.5	6	25	50	1.5	0.84	2
080R-25.4-10-LN10	10	80	60	25.4	14	25	35	9.5	6	25	50	1.5	0.84	2
100R-31.75-10-LN10	10	100	67	31.75	18	26	42	12.7	8	32	56	1.5	1.48	2
100R-31.75-11-LN10	11	100	67	31.75	18	26	42	12.7	8	32	56	1.5	1.48	2
100R-31.75-12-LN10	12	100	67	31.75	18	26	42	12.7	8	32	56	1.5	1.48	2

Available inserts

LNMX-ML LNMX-MF LNMX-MM



Designation	Cermet		Coated										Uncoated		page			
	CN2500	CN80	NC5330	NCM325	NCM335	NCM535	NCM545	PC2505	PC2510	PC3700	PC6510	PC9530	PC9540	PC5300		PC5400	ST30A	H01
LNMX 100412R-ML													●	●	●			E12
100412R-MF									●	●			●	●	●			
100412R-MM									●	●			●	●				

Available arbors

Designation	Ød	Available arbors
HFMDCM 040R-16-□-LN10	Ø40	BT□□-FMC16-□□
042R-16-□-LN10	Ø42	
050R-22-□-LN10	Ø50	BT□□-FMC22-□□
052R-22-□-LN10	Ø52	
063R-22-□-LN10	Ø63	

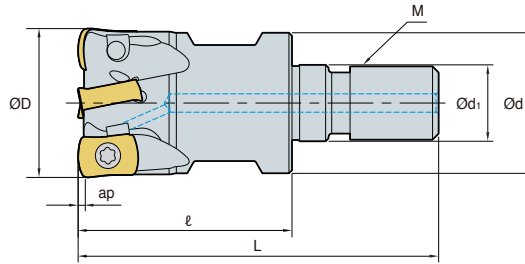
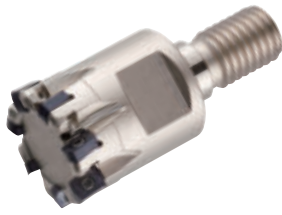
Designation	Ød	Available arbors
HFMDCM 066R-22-□-LN10	Ø66	BT□□-FMC22-□□
080R-27-□-LN10	Ø80	BT□□-FMC27-□□
100R-32-□-LN10	Ø100	BT□□-FMC32-□□
HFMDC 080R-25.4-□-LN10	Ø80	BT□□-FMA25.4-□□
100R-31.75-□-LN10	Ø100	BT□□-FMA31.75-□□

Parts

Specification	Screw	Wrench
Ø40~Ø100	FTNA0408	TW15S

Available inserts E12 Available arbors and bolt E426~E428

HFMDM-LN04 new



• AR: -8°
• RR: -16°~-10°

(mm)

Designation		ØD	Ød	Ød1	ℓ	L	M	ap	
HFMDM 010R-2-M06-LN04	2	10	9.5	6.5	22	37	M6	0.4	0.01
011R-2-M06-LN04	2	11	11	6.5	22	37	M6	0.5	0.01
012R-3-M06-LN04	3	12	11	6.5	22	37	M6	0.5	0.01
013R-3-M06-LN04	3	13	11	6.5	22	37	M6	0.5	0.02
016R-4-M08-LN04	4	16	14.5	8.5	22	39	M8	0.5	0.03
017R-4-M08-LN04	4	17	14.5	8.5	22	39	M8	0.5	0.03
020R-5-M10-LN04	5	20	18	10.5	30	51	M10	0.5	0.06
025R-7-M12-LN04	7	25	23	12.5	30	54	M12	0.5	0.1
032R-8-M16-LN04	8	32	29	17	35	62	M16	0.5	0.2
033R-8-M16-LN04	8	33	29	17	35	62	M16	0.5	0.2
035R-9-M16-LN04	9	35	29	17	35	62	M16	0.5	0.21

Available inserts

LNMX-ML LNMX-MM



Designation	Cermet		Coated										Uncoated		page			
	CN2500	CN30	NC5330	NCM325	NCM335	NCM535	NCM545	PC2505	PC2510	PC3700	PC6510	PC9530	PC9540	PC5300		PC5400	ST30A	H01
LNMX 040205R-ML														●	●			E12
040205R-MM								●	●					●	●			

Available adaptor

Designation	Available adaptor
HFMDM 010R-2-M06-LN04	MAT-M06
011R-2-M06-LN04	
012R-3-M06-LN04	
013R-3-M06-LN04	
016R-4-M08-LN04	MAT-M08
017R-4-M08-LN04	

Designation	Available adaptor
HFMDM 020R-5-M10-LN04	MAT-M10
025R-7-M12-LN04	MAT-M12
032R-8-M16-LN04	MAT-M16
033R-8-M16-LN04	
035R-8-M16-LN04	

Designation : HFMDM016R-4-M08-LN04
Modular head threading measure size (M08)

||

Adaptor spec.: MAT-M08-040-S16T
Adaptor threading measure (M08)

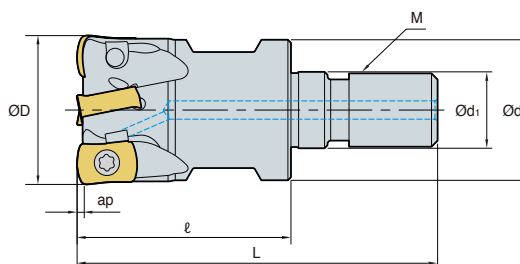
Parts

Specification		
Ø10~Ø35	FTKA01844-A	TW06S-A

Available inserts E12 Available adaptor E401-E402



HFMDM-LN06 new



• AR: -9°
• RR: -15°~10°

(mm)

Designation		ØD	Ød	Ød1	ℓ	L	M	ap	
HFMDM 016R-2-M08-LN06	2	16	14.5	8.5	25	42	M08	0.7	0.03
017R-2-M08-LN06	2	17	14.5	8.5	25	42	M08	1.0	0.03
018R-2-M08-LN06	2	18	14.5	8.5	25	42	M08	1.0	0.04
019R-2-M08-LN06	2	19	14.5	8.5	25	42	M08	1.0	0.05
020R-3-M10-LN06	3	20	18	10.5	30	51	M10	1.0	0.06
021R-3-M10-LN06	3	21	18	10.5	30	51	M10	1.0	0.07
025R-4-M12-LN06	4	25	23	12.5	35	59	M12	1.0	0.10
026R-4-M12-LN06	4	26	23	12.5	35	59	M12	1.0	0.10
032R-5-M16-LN06	5	32	29	17	40	67	M16	1.0	0.20
033R-5-M16-LN06	5	33	29	17	40	67	M16	1.0	0.20
035R-5-M16-LN06	5	35	29	17	40	67	M16	1.0	0.21
040R-6-M16-LN06	6	40	29	17	40	67	M16	1.0	0.24
042R-6-M16-LN06	6	42	29	17	40	67	M16	1.0	0.25

Available inserts

LNX-ML LNX-MF LNX-MM



Designation	Cermet		Coated										Uncoated		page			
	CN2500	CN80	NC5330	NCM325	NCM335	NCM635	NCM545	PC2505	PC2510	PC3700	PC6510	PC9530	PC9540	PC5300		PC5400	ST30A	H01
LNX 060310R-ML														●	●			E12
060310R-MF									●	●				●	●			
060310R-MM									●	●				●	●			

Available adaptor

Designation	Available adaptor
HFMDM 016R-□-M08-LN06	MAT-M08
017R-□-M08-LN06	
018R-□-M08-LN06	
019R-□-M08-LN06	
020R-□-M10-LN06	MAT-M10
021R-□-M10-LN06	
025R-□-M12-LN06	MAT-M12

Designation	Available adaptor
HFMDM 026R-□-M12-LN06	MAT-M12
030R-□-M16-LN06	MAT-M16
032R-□-M16-LN06	
033R-□-M16-LN06	
040R-□-M16-LN06	
042R-□-M16-LN06	

Designation : HFMDM025R-□-M12-LN06
Modular head threading measure size (M12)

||

Adaptor spec.: MAT-M12-050-S25T
Adaptor threading measure (M06)

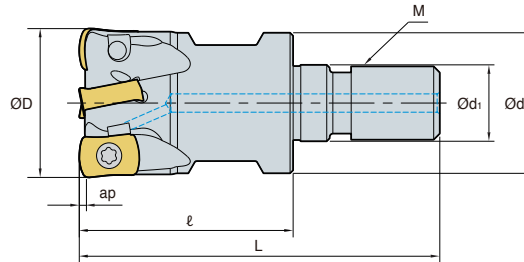
Parts

Specification		
Ø16~Ø42	FTNA0306	TW09S

Available inserts E12 Available adaptor E401~E402



HFMDM-LN10 new



• AR: -9°
• RR: -16°~-13°

(mm)

Designation		ØD	Ød	Ød1	ℓ	L	M	ap	
HFMDM 025R-2-M12-LN10	2	25	23	12.5	35	59	M12	1.5	0.10
025R-3-M12-LN10	3	25	23	12.5	35	59	M12	1.5	0.10
026R-3-M12-LN10	3	26	23	12.5	35	59	M12	1.5	0.10
030R-4-M16-LN10	4	30	29	17.0	40	67	M16	1.5	0.17
032R-3-M16-LN10	3	32	29	17.0	40	67	M16	1.5	0.19
032R-4-M16-LN10	4	32	29	17.0	40	67	M16	1.5	0.19
033R-4-M16-LN10	4	33	29	17.0	40	67	M16	1.5	0.19
035R-3-M16-LN10	3	35	29	17.0	40	67	M16	1.5	0.20
035R-4-M16-LN10	4	35	29	17.0	40	67	M16	1.5	0.20
040R-4-M16-LN10	4	40	29	17.0	40	67	M16	1.5	0.22
040R-5-M16-LN10	5	40	29	17.0	40	67	M16	1.5	0.22
042R-4-M16-LN10	4	42	29	17.0	40	67	M16	1.5	0.25
042R-5-M16-LN10	5	42	29	17.0	40	67	M16	1.5	0.25

Available inserts

LNMX-ML LNMX-MF LNMX-MM



Designation	Cermet		Coated										Uncoated		page			
	CN2500	CN30	NC5330	NCM325	NCM335	NCM335	NCM645	PC2505	PC2510	PC3700	PC6510	PC9530	PC9540	PC5300		PC5400	ST30A	H01
LNMX 100412R-ML																		E12
100412R-MF								●	●				●	●	●			
100412R-MM								●	●				●	●				

Available adaptor

Designation	Available adaptor
HFMDM 025R-□-M12-LN10	MAT-M12
026R-□-M12-LN10	
030R-□-M16-LN10	MAT-M16
032R-□-M16-LN10	

Designation	Available adaptor
HFMDM 033R-□-M16-LN10	MAT-M16
035R-□-M16-LN10	
040R-□-M16-LN10	
042R-□-M16-LN10	
042R-□-M16-LN10	

Designation : HFMDM035R-□-M16-LN10
Modular head threading measure size (M16)

||

Adaptor spec.: MAT-M16-035-S32S
Adaptor threading measure (M16)

Parts

Specification		
Ø25~Ø42	FTNA0408	TW15S

Available inserts E12 Available adaptor E401-E402



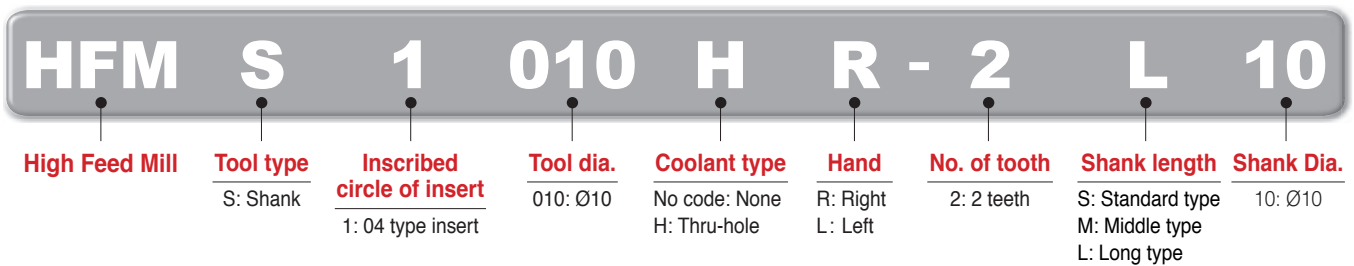
Stable machining, high efficiency milling tools for small diameter machining

HFM *new*

- Increase productivity through improved insert shape and size, high feed per tooth, and many cutting-edges, for small diameter machining
- Stable tool life through the combination of the reinforced toughness on corner and suitable grades of high hardness in the area of high speed and high hardness

🔗 Code system

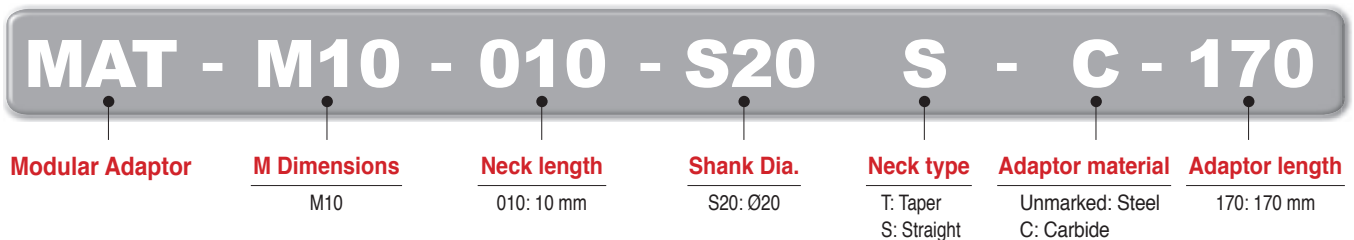
• Shank



• Modular



• Modular adaptor

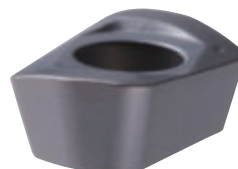


🔗 Features

- Apply helix cutting-edge on insert, low cutting load and reinforce toughness on corner
- Increased rigidity with double relief angle (11, 13), prevent interference with high feed
- To apply the negative axial rake angle when set up the holder, increased chipping resistance
- Tool life is increased with suitable C/B and grade for every material





- **Holder setup**
 - To set up the negative axial rake angle, increased chipping resistance
- **No. of tooth**
 - Increased tool life with increased flutes
 - HRM(D) Ø20 (2 flutes) → HFM Ø20 (5 flutes)



- **Relief angle**
 - 11, 13 double relief angle increase rigidity and prevent interference
- **Major cutting-edge**
 - Improved sharpness of principle edge
 - Improved toughness of corner edge

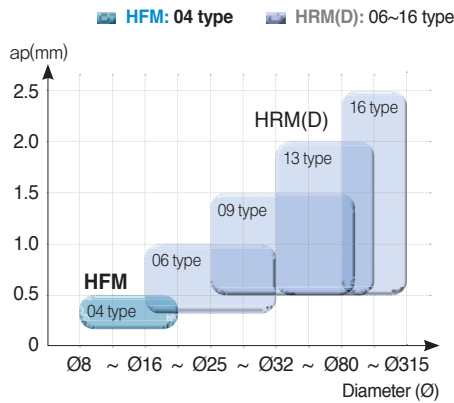
E Technical Information for HFM

Features of chip breaker

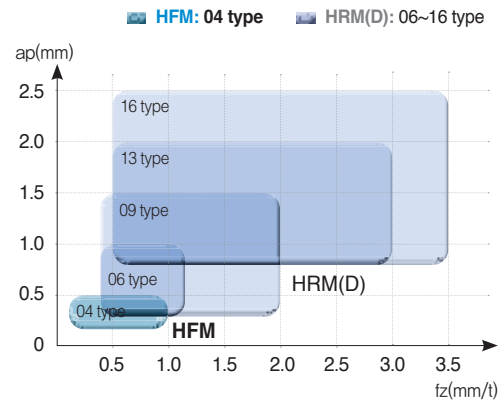
Insert	Cutting-edge	Uses	Features
MF		Light cutting Titanium & Inconel machining	Low cutting resistance C/B, suitable for light cutting
None C/B		Super hard material machining	High toughness shape, suitable for hard die steel cutting

Application area

Application area (ap & Diameter)



Application area (ap & fz)



Recommended cutting condition

※ Recommended chip breaker: ● 1st ○ 2nd



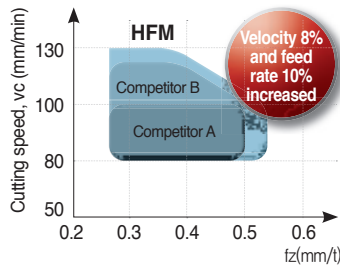
Workpiece	Workpiece			HB (HRC)	Grades	Cutting conditions				Chip breaker		
	KOR (KS)	USA (AISI)	GER (DIN)			vc (m/min)	fz (mm/t)	ap (mm)	ae	MF	None C/B	
P	Mild steel	SM20C	1020	C22	120~180	PC5400 (PC5300)	100~220	0.5~1.0	~0.5	0.7D~0.1D	●	-
	Carbon steel	SM45C	1045	C45	200	PC5400 (PC5300)	100~200	0.5~1.0	~0.5	0.7D~0.1D	●	-
	Alloy steel	SCM440	4140	41CrMo4	270(28)	PC5300	100~200	0.5~1.0	~0.5	0.7D~0.1D	●	-
	Pre-hardened steel	KP4M	P20 (Improved)	1.2738 (Improved)	300(32)	PC5300 (PC2510)	new 100~180	0.5~0.9	~0.4	0.7D~0.1D	●	○
		NIMAX	P21 (Improved)	-	370(40)	PC5300 (PC2510)	new 100~180	0.5~0.9	~0.4	0.7D~0.1D	●	○
		CENA1	P21 (Improved)	-	370(40)	PC5300 (PC2510)	new 100~180	0.5~0.9	~0.4	0.7D~0.1D	●	○
		NAK80	P21 (Improved)	-	400(43)	PC5300	100~160 100~180	0.5~0.7 0.5~0.9	~0.4	0.7D~0.1D	○ -	- ●
	STAVAX	420	X30Cr13	510(52)	PC2510 (PC5300)	new 80~150	0.3~0.6	~0.4	0.7D~0.1D	●	-	
	Alloy tool steel	STD11 STD61	D2 H13	X155CrVMo12-1 X40CrMoV5-1	- (40~50)	PC2510 (PC2505)	new 80~130	0.3~0.55	~0.3	0.7D~0.1D	-	●
STD11 (Cold forging)		D2	X155CrVMo12-1	630(60)	PC2505	new 30~75	0.3~0.5	~0.2	0.7D~0.1D	-	●	
M	Stainless steel	STS316	316	X5CrNiMo17-12-2	Under 270	PC5400 (PC5300)	70~150	0.5~0.7	~0.5	0.7D~0.1D	●	-
K	Gray cast iron, Ductile cast iron	GCD450	65-45-12	GGG40.3	Tensile Strength Over 450Mpa	PC5300	130~220	0.6~0.8	~0.5	0.7D~0.1D	●	-
S	HRSA Fe series Ni or Co series	Incoloy901	N09901	- (WS 2.4662)	- (25~35)	PC5300 (PC5400)	30~100	0.3~0.5	~0.3	0.4D~0.7D	●	○
		Inconel718	N07718	NiCr19FeNbMo (WS 2.4668)	- (35~45)	PC5300 (PC5400)	20~50	0.3~0.6	~0.3	0.4D~0.7D	●	○
	Titanium	Ti-6Al-4V	R56400	TiAl6V4	- (40~45)	PC5300	30~50	0.4~1.0	~0.3	0.7D~0.1D	●	-



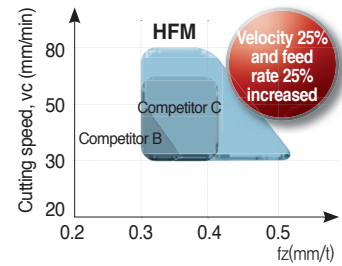
Performance evaluation

High speed machining

- **Workpiece**
STD11 (HRC40~45)
- **Insert**
LPM(E)W0402□□R
- **Recommended grade**
PC2505 (1st), PC2510 (2nd)

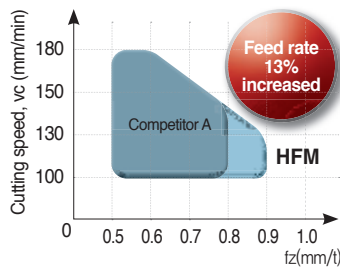


- **Workpiece**
STD11 (Over HRC60)
- **Insert**
LPM(E)W0402□□R
- **Recommended grade**
PC2505 (1st), PC2510 (2nd)

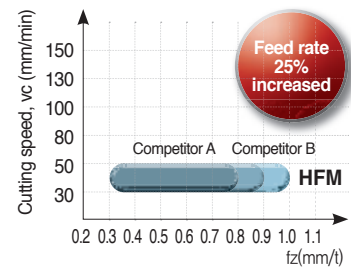


High feed machining

- **Workpiece**
KP4M (HRC32),
NAK80 (HRC43)
- **Insert**
LPMT0402□□R-MF
- **Recommended grade**
PC5300 (1st), PC2510 (2nd)



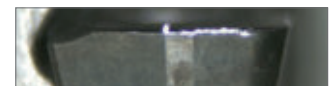
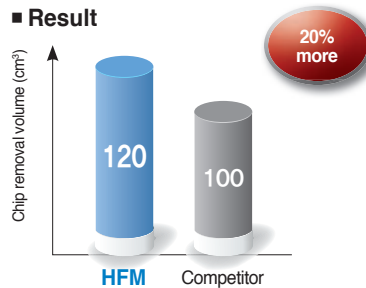
- **Workpiece**
Ti-6Al-4V (HRC40~45)
- **Insert**
LPMT0402□□R-MF
- **Recommended grade**
PC5300 (1st), PC5400 (2nd)



Machining example

Alloy tool steel [X155CrVMo12-1 (DIN)/D2 (AISI)/STD11 (KS), HRC40~45]

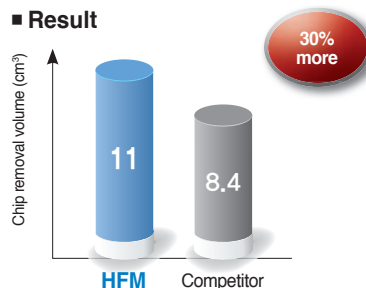
- **Workpiece** Mold
- **Cutting conditions** vc (m/min) = 80, fz (mm/t) = 0.5
 ap (mm) = 0.3, ae (mm) = 10
dry
- **Tools** **Insert** LPMW040210R (PC2510)
Holder HFMS1016HR-4S16



- Chip removal rate Q (cm³/min): 4.8
- Cutting time (min): 25

Alloy tool steel [X155CrVMo12-1 (DIN)/D2 (AISI)/STD11 (KS), HRC60]

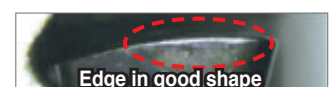
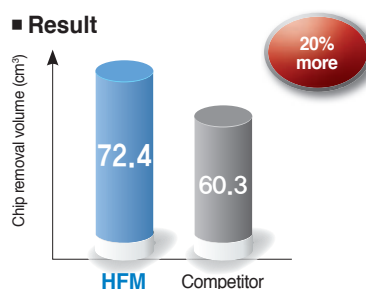
- **Workpiece** Mold
- **Cutting conditions** vc (m/min) = 75, fz (mm/t) = 0.4
 ap (mm) = 0.15, ae (mm) = 5
dry
- **Tools** **Insert** LPMW040210R (PC2505)
Holder HFMS1010HR-2S10



- Chip removal rate Q (cm³/min): 1.4
- Cutting time (min): 7.85

HRSA [TiAl6V4 (DIN)/R56400 (AISI)/Ti-6Al-4V (KS), HRC48]

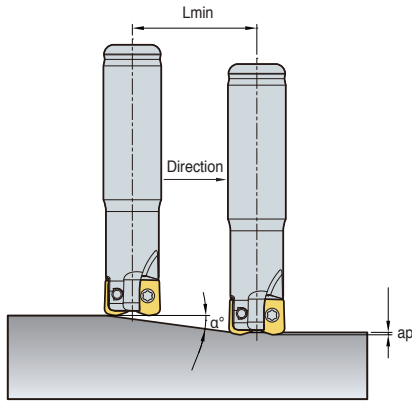
- **Workpiece** Aviation parts
- **Cutting conditions** vc (m/min) = 50, fz (mm/t) = 1.2
 ap (mm) = 0.3, ae (mm) = 10
wet
- **Tools** **Insert** LPMT040210R-MF (PC5300)
Holder HFMS1016HR-4S16



- Chip removal rate Q (cm³/min): 7.2
- Cutting time (min): 10.05

Ramping and helical cutting

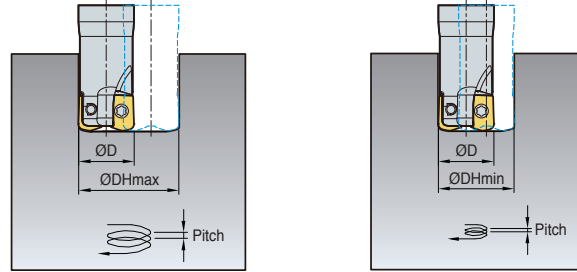
Ramping



$$L_{min} = \frac{ap}{\tan \alpha} \text{ (mm)}$$

※ Lmin: Min. inclination cutting length
 α°: Max. ramping angle
 ap: Depth of cut

Helical cutting



- ØD = Tool dia. (mm)
- Ød = Tool path (mm) = ØDHmin, Max - ØD
- ØDHmin (Min diameter, mm) = ØD × 2 - 5.4
- ØDHmax (Max diameter, mm) = ØD × 2 - 2

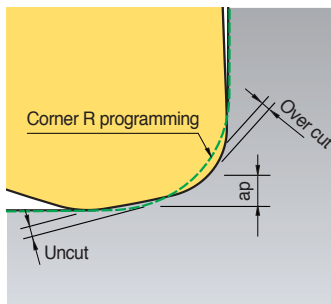
(mm)

Designation	Tool dia. ØD	Depth of cut ap	Ramping		Helical cutting		
			Max ramping angle α (°)	Lmin	Max diameter ØDHMax	Min diameter ØDHMin	Max pitch dmax
HFMS1010HR	10	0.4~0.5	3.5	7	18	15	0.4
HFMS1011HR	11	0.4~0.5	3.1	8	20	17	0.4
HFMS1012HR	12	0.4~0.5	2.7	9	22	19	0.4
HFMS1013HR	13	0.4~0.5	2.4	10	24	21	0.4
HFMS1014HR	14	0.4~0.5	2.2	11	26	23	0.4
HFMS1015HR	15	0.4~0.5	2.0	12	28	25	0.4
HFMS1016HR	16	0.4~0.5	1.8	13	30	27	0.4
HFMS1017HR	17	0.4~0.5	1.7	14	32	29	0.4
HFMS1018HR	18	0.4~0.5	1.6	15	34	31	0.4
HFMS1019HR	19	0.4~0.5	1.5	16	36	33	0.4
HFMS1020HR	20	0.4~0.5	1.4	17	38	35	0.4
HFMS1021HR	21	0.4~0.5	1.3	18	40	37	0.4
HFMM1025HR	25	0.4~0.5	1.1	22	48	45	0.4
HFMM1026HR	26	0.4~0.5	1.0	23	50	47	0.4
HFMM1030HR	30	0.4~0.5	0.9	27	58	55	0.4
HFMM1032HR	32	0.4~0.5	0.8	29	62	59	0.4
HFMM1033HR	33	0.4~0.5	0.8	30	64	61	0.4

- Adjust feed to under 70% of recommended cutting condition when ramping & helical cutting
- In helical ramping, max. cutting depth per 1 helical revolution of cutter should not exceed max. cutting depth as per insert size
- In ramping, max. cutting depth per 1 ramping process of cutter should not exceed max. depth of cut as per used insert size

Corner R programming

(mm)

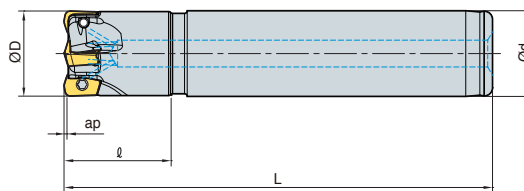


Insert	Corner R programming	Cutting conditions		Over Cut	Uncut
		Nose R	Max. ap		
LPMT040210R-MF	R1.0 (Standard)	1.0	0.4	0	0.17
LPMW040210R	R1.5			0.10	0.08
LPEW040210R	R2.0			0.31	0
LPMT040220R-MF	R1.0	2.0	0.5	0	0.41
LPMW040220R	R1.5			0	0.2
LPEW040220R	R2.0 (Standard)			0	0

- When using CNC program, overcut & uncut occurs on the corner processing site if entering the correct program corner R value for each insert
- To prevent overcut, you will need to complete a CNC program considering the above overcut



HFMS1000 new



AA
13°
• AR: -4°
• RR: -14°~-7°

(mm)

Designation		ØD	Ød	l	L	ap	
HFMS 1008HR-1S10	1	8	10	20	80	0.4~0.5	0.03
1008HR-1M10	1	8	10	25	100	0.4~0.5	0.03
1008HR-1L10	1	8	10	35	120	0.4~0.5	0.03
1010HR-2S08	2	10	8	20	80	0.4~0.5	0.03
1010HR-2M08	2	10	8	25	100	0.4~0.5	0.04
1010HR-2L08	2	10	8	35	120	0.4~0.5	0.04
1010HR-2S10	2	10	10	20	80	0.4~0.5	0.04
1010HR-2M10	2	10	10	25	105	0.4~0.5	0.05
1010HR-2L10	2	10	10	35	120	0.4~0.5	0.06
1011HR-2S10	2	11	10	20	80	0.4~0.5	0.04
1011HR-2M10	2	11	10	25	105	0.4~0.5	0.06
1011HR-2L10	2	11	10	35	120	0.4~0.5	0.07
1012HR-3S10	3	12	10	20	80	0.4~0.5	0.05
1012HR-3M10	3	12	10	25	105	0.4~0.5	0.06
1012HR-3L10	3	12	10	35	120	0.4~0.5	0.07
1012HR-3S12	3	12	12	20	80	0.4~0.5	0.06
1012HR-3M12	3	12	12	25	105	0.4~0.5	0.08
1012HR-3L12	3	12	12	35	120	0.4~0.5	0.09
1013HR-3S12	3	13	12	20	80	0.4~0.5	0.06
1013HR-3M12	3	13	12	25	105	0.4~0.5	0.09
1013HR-3L12	3	13	12	40	120	0.4~0.5	0.10
1014HR-3S12	3	14	12	20	80	0.4~0.5	0.07
1014HR-3M12	3	14	12	25	105	0.4~0.5	0.09
1014HR-3L12	3	14	12	40	120	0.4~0.5	0.10

Available inserts



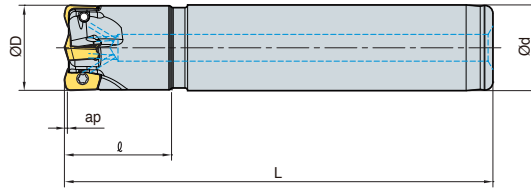
Designation	Cermet		Coated										Uncoated			page			
	CN2500	CN30	NC5330	NCM325	NCM335	NCM535	NCM545	PC2505	PC2510	PC3700	PC6510	PC9530	PC9540	PC5300	PC5400		ST30A	G10	H01
LPMT 040210R-MF								●						●	●				E12
040220R-MF								●	●					●	●				
LPMW 040210R								●	●					●	●				E13
040220R								●	●					●	●				
LPEW 040210R								●	●					●	●				
040220R								●	●					●	●				

Parts

Specification		
Ø8~Ø10	FTKA01840	TW06S-A
Ø11~Ø14	FTKA01842	

Available inserts E12, E13

HFMS1000 new



AA
13°
• AR: -4°
• RR: -6°~3°

(mm)

Designation		ØD	Ød	ℓ	L	ap	
HFMS 1015HR-4S12	4	15	12	20	80	0.4~0.5	0.07
1015HR-4M12	4	15	12	25	105	0.4~0.5	0.09
1015HR-4L12	4	15	12	40	120	0.4~0.5	0.11
1016HR-4S16	4	16	16	20	80	0.4~0.5	0.11
1016HR-4M16	4	16	16	25	105	0.4~0.5	0.14
1016HR-4L16	4	16	16	40	120	0.4~0.5	0.16
1017HR-4S16	4	17	16	20	80	0.4~0.5	0.11
1017HR-4M16	4	17	16	25	105	0.4~0.5	0.15
1017HR-4L16	4	17	16	40	120	0.4~0.5	0.17
1018HR-4S16	4	18	16	20	80	0.4~0.5	0.11
1018HR-4M16	4	18	16	25	105	0.4~0.5	0.15
1018HR-4L16	4	18	16	40	120	0.4~0.5	0.17
1019HR-4S16	4	19	16	20	80	0.4~0.5	0.12
1019HR-4M16	4	19	16	25	105	0.4~0.5	0.16
1019HR-4L16	4	19	16	40	120	0.4~0.5	0.18
1020HR-4S20	4	20	20	20	80	0.4~0.5	0.17
1020HR-4M20	4	20	20	25	105	0.4~0.5	0.22
1020HR-4L20	4	20	20	40	120	0.4~0.5	0.26
1020HR-5S20	5	20	20	20	80	0.4~0.5	0.17
1020HR-5M20	5	20	20	25	105	0.4~0.5	0.23
1020HR-5L20	5	20	20	40	120	0.4~0.5	0.27
1021HR-5S20	5	21	20	20	80	0.4~0.5	0.17
1021HR-5M20	5	21	20	25	105	0.4~0.5	0.23
1021HR-5L20	5	21	20	40	120	0.4~0.5	0.27

Available inserts



Designation	Cermet		Coated										Uncoated			page		
	CN2500	CN30	NC5330	NCM325	NCM335	NCM535	NCM545	PC2505	PC2510	PC3700	PC6510	PC9530	PC9540	PC5300	PC5400		ST30A	G10
LPMT 040210R-MF								●	●					●	●			
040220R-MF								●	●					●	●			
LPMW 040210R								●	●					●	●			
040220R								●	●					●	●			
LPEW 040210R								●	●					●	●			
040220R								●	●					●	●			

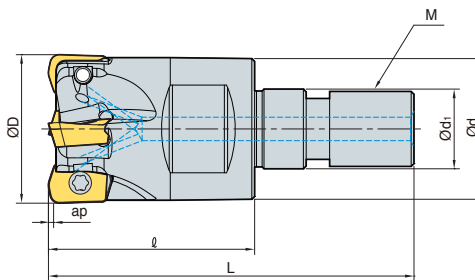
Parts

Specification		
Ø15~Ø21	FTKA01842	TW06S-A

Available inserts E12, E13



HFMM new



• AR: -4°
• RR: -14°~-3°

(mm)

Designation										
Designation		ØD	Ød	Ød ₁	l	L	M	ap		
HFMM 1008HR-M06	1	8	9.5	6.5	17	32	M06	0.4~0.5	0.01	
1010HR-M06	2	10	9.5	6.5	17	32	M06	0.4~0.5	0.01	
1011HR-M06	2	11	9.5	6.5	17	32	M06	0.4~0.5	0.01	
1012HR-M06	3	12	11	6.5	19	34	M6B	0.4~0.5	0.01	
1013HR-M06	3	13	11	6.5	19	34	M6B	0.4~0.5	0.01	
1016HR-M08	4	16	14.5	8.5	22	39	M08	0.4~0.5	0.03	
1017HR-M08	4	17	14.5	8.5	22	39	M08	0.4~0.5	0.03	
1020HR-M10	5	20	18	10.5	25	46	M10	0.4~0.5	0.06	
1021HR-M10	5	21	18	10.5	25	46	M10	0.4~0.5	0.06	
1025HR-M12	6	25	23	12.5	27	51	M12	0.4~0.5	0.11	
1026HR-M12	6	26	23	12.5	27	51	M12	0.4~0.5	0.11	
1030HR-M16	7	30	29	17	30	60	M16	0.4~0.5	0.17	
1032HR-M16	8	32	29	17	30	60	M16	0.4~0.5	0.18	
1033HR-M16	8	33	29	17	30	60	M16	0.4~0.5	0.18	

Available inserts



Designation	Cermet		Coated										Uncoated			page		
	CN2500	CN30	NC5330	NCM325	NCM335	NCM535	NCM545	PC2505	PC2510	PC3700	PC6510	PC9530	PC9540	PC5300	PC5400		ST30A	G10
LPMT 040210R-MF								●	●					●	●			
040220R-MF								●	●					●	●			
LPMW 040210R								●	●					●	●			
040220R								●	●					●	●			
LPEW 040210R								●	●					●	●			
040220R								●	●					●	●			

Available adaptor

Designation	Available adaptor	Designation	Available adaptor
HFMM 1008HR-M06	MAT-M06	HFMM 1020HR-M10	MAT-M10
1010HR-M06		1021HR-M10	
1011HR-M06		MAT-M12	
1012HR-M06			1025HR-M12
1013HR-M06			1026HR-M12
1016HR-M08	MAT-M08	1030HR-M16	MAT-M16
1017HR-M08		1032HR-M16	
		1033HR-M16	

Designation : HFMM1008HR-M06
Modular head threading measure size (M06)

II

Adaptor spec.: MAT-M06-020-S10S
Adaptor threading measure (M06)

Parts

Specification		
Ø8~Ø10	FTKA01840	TW06S-A
Ø11~Ø33	FTKA01842	

Available inserts E12, E13

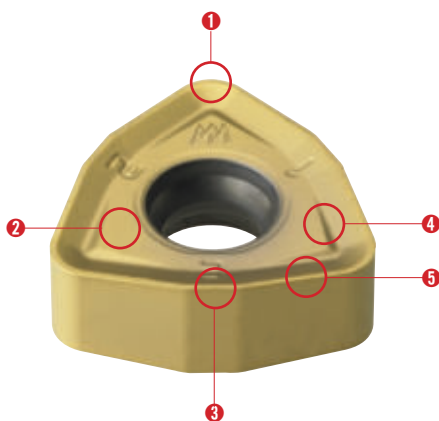
Available adaptor E401~E402

HRMD is more economical due to the use of 6 cutting-edges compared to HRM tool with a 3-edge positive insert

HRMDouble

- HRMD is more economical due to the use of 6 cutting-edges compared to HRM tool with a 3-edge positive insert
- High-rake angle cutting-edge and chip breaker reduces cutting load
- Negative geometry has been designed for rigidity of cutting-edge and double-sided function
- Screw on system and stable support achieves strong clamping force
- Unique insert design for high feed and multifunctional machining
- HRMD insert with symmetrical cutting-edge is applicable for both R and L type machining

Features of insert



1 Nose-R

- Security of rigid edge in ramping pocket machining
- Round edge suitable for high feed rates insert geometry
- Possible to use R/L type machining

2 Clamping surface

- Design for stable clamping
- Prevention of friction by chip

3 Minor cutting-edge

- Improvement of surface roughness in high feed machining
- Special design for decreasing thrust force
- Symmetrical insert design for R/L type tool

4 Chip breaker

- Reduction of cutting load due to High-rake angle
- Improvement of chip flow and evacuation in various applications
- Prevention of damage on clamping face of insert

5 Major cutting-edge

- Symmetrical design insert for R/L type tool
- Superior cutting performance due to high rake angle cutting-edge
- Low cutting resistance in high feed
- Special design for decreasing thrust force

Features of cutter



Inner coolant system

- Improvement of chip control and evacuation
- Longer tool life due to reduced cutting temperature

3-surface constrained system

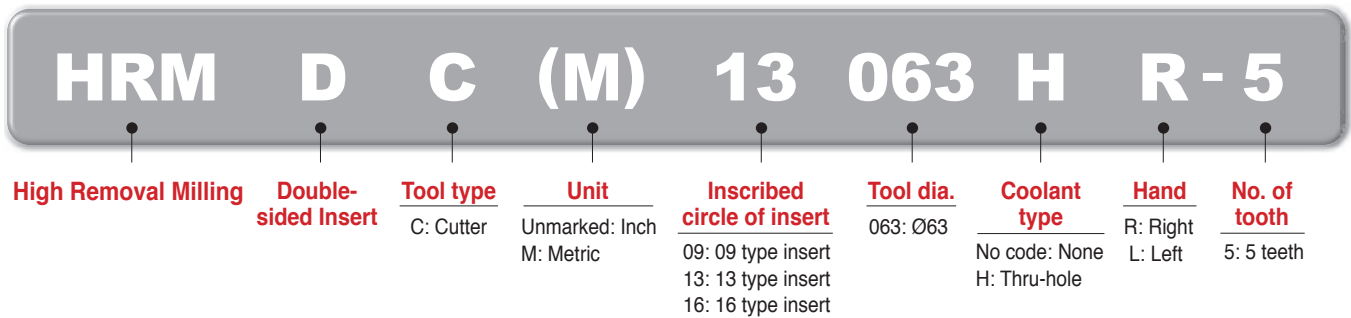
- Strong clamping system
- Stable clamping system against different cutting resistances in various machining applications

Simple screw on system

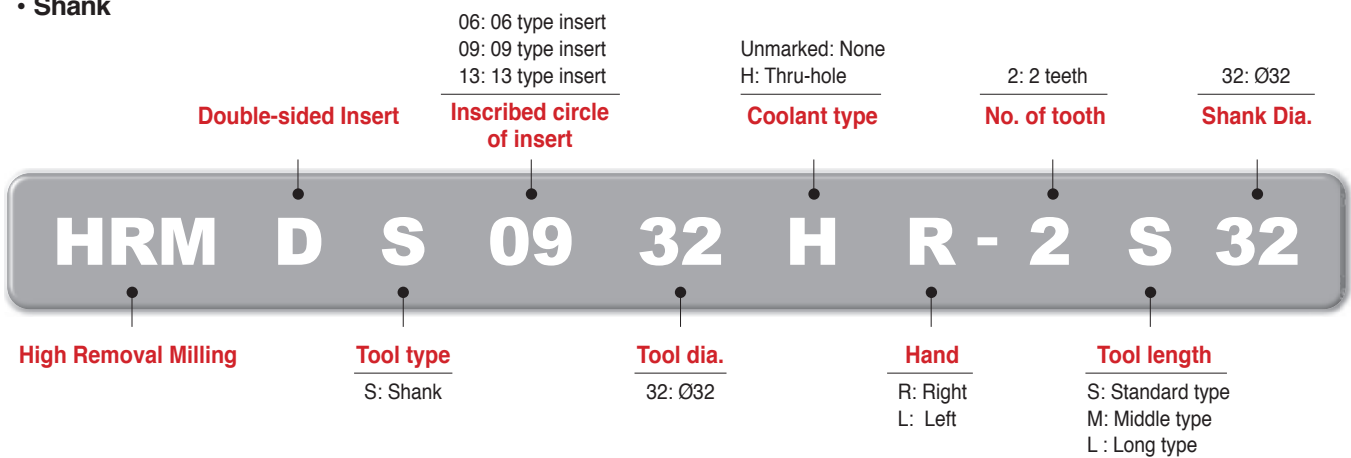
- Strong clamping of screw on system
- Convenient clamping system
- Wide chip pocket for better chip evacuation

Code system

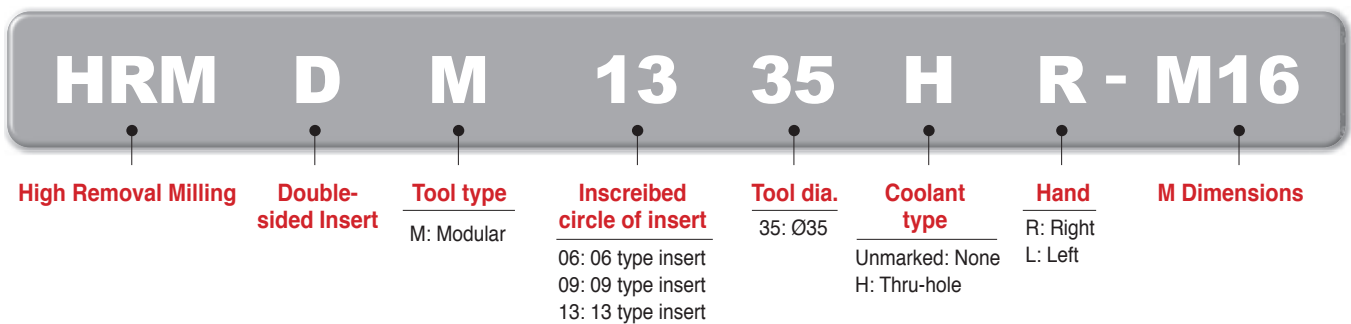
• Cutter



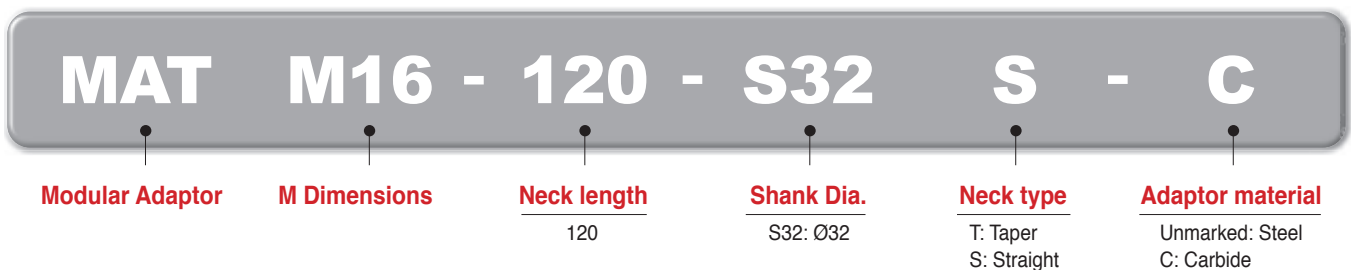
• Shank



• Modular head



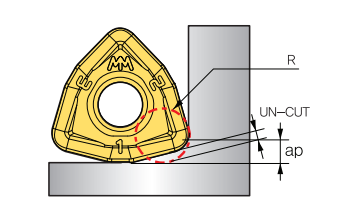
• Modular adaptor



Corner R programming

Designation	Cutting condition		Approx. R (mm)	
	Max.ap (mm)	Max.fz (mm/t)	Input. R	Uncut
WNMX060312ZNN-□□	1.0	1.2	1.8	0.4
WNMX09T316ZNN-□□	1.5	2.0	2.5	0.6
WNMX130520ZNN-□□	2.0	3.0	3.0	0.8
WNMX160720ZNN-□□	2.5	3.5	3.5	1.2

Information for uncut part by using "Input.R" for CAM program

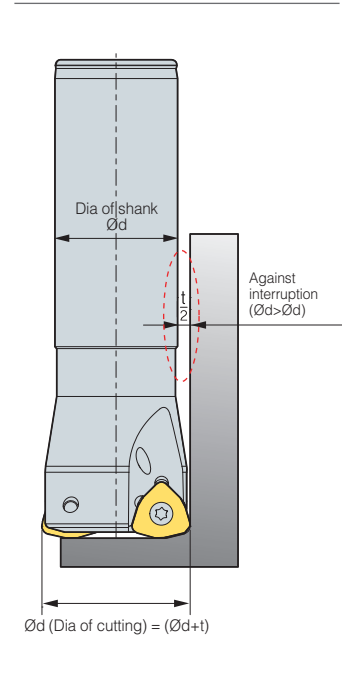


Uncut part can be changed by poor machine condition or weak clamp of workpiece, etc

Interference prevent system

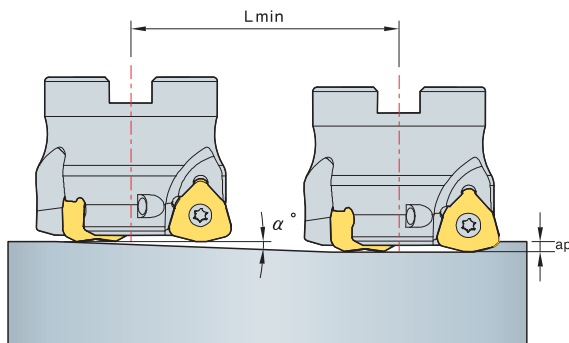
Designation	ØD (mm)	Ød (mm)	t (mm)
HRMDS0617HR-2□16	17	16	1
HRMDS0618HR-2□16	18	16	2
HRMDS0621HR-2□20	21	20	1
HRMDS0626HR-3□25	26	25	1
HRMDS0633HR-4□32	33	32	1
HRMDS0926HR-2□25	26	25	1
HRMDS0933HR-3□32	33	32	1
HRMDS0935HR-4□32	35	32	3
HRMDS0940HR-4□32	40	32	8
HRMDS0950HR-5□32	50	32	18
HRMDS0950HR-5□40	50	40	10
HRMDS0950HR-5□42	50	42	8
HRMDS1333HR-3□32	33	32	1
HRMDS1335HR-4□32	35	32	3
HRMDS1340HR-4□30	40	30	8
HRMDS1350HR-4□32	50	32	18
HRMDS1350HR-4□40	50	40	10
HRMDS1350HR-4□42	50	42	8
HRMDS1363HR-5□32	63	32	31
HRMDS1363HR-5□40	63	40	23
HRMDS1363HR-5□42	63	42	21

The side clearance prevents to interference between tool and workpiece even in deep hole machining

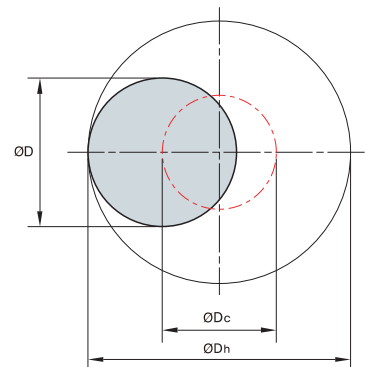


Ramping & helical cutting technical data

Ramping



Helical cutting



$$L_{min} = \frac{ap}{\tan \alpha^\circ} \text{ (mm)}$$

$$\varnothing D_c = \varnothing D_h - \varnothing D$$

$\varnothing D_c$ = Tool pass of tool center

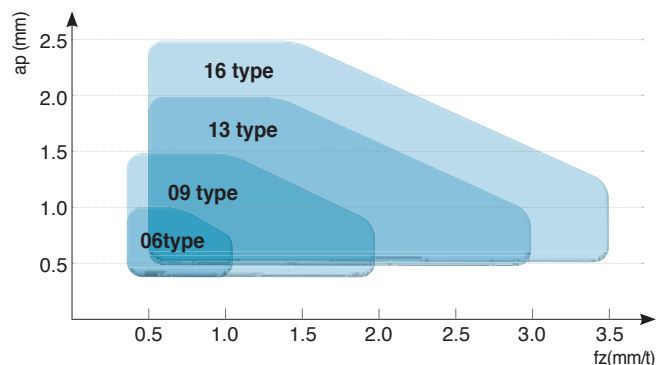
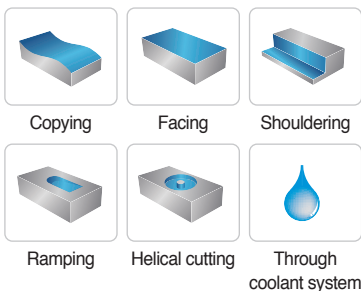
$\varnothing D_h$ = Desirable hole diameter on workpiece

$\varnothing D$ = Tool dia.

- Adjust feed to under 70% of Recommended cutting condition when ramping & helical cutting
- In helical ramping, max. cutting depth per 1 helical revolution of cutter should not exceed max. cutting depth as per insert size
- in ramping, max. cutting depth for 1 ramping process should not exceed max. depth of cut as per used insert size

Designation	Tool dia. $\varnothing D$ (mm)	Efficient cutting diameter $\varnothing D_e$ (mm)	Ramping			Helical ramping	
			Max. ap (mm)	Max. angle α°	Cutting Length L_{min} (mm)	Dh Min. Cutting diameter (mm)	Dh Max. Cutting diameter (mm)
HRMDS0616HR	16	9.5	1	4.8	11	23.8	29.6
HRMDS0617HR	17	10.5	1	4.1	13	25.8	31.6
HRMDS0618HR	18	11.5	1	3.5	16	27.8	33.6
HRMDS0620HR	20	13.5	1	2.5	22	31.8	37.6
HRMDS0621HR	21	14.5	1	2.2	26	33.8	39.6
HRMDS0625HR	25	18.5	1	1.3	44	41.8	47.6
HRMDS0626HR	26	19.5	1	1.2	47	43.8	49.6
HRMDS0632HR	32	25.5	1	0.6	95	55.8	61.6
HRMDS0633HR	33	26.5	1	0.5	114	57.8	63.6
HRMDS0925HR	25	15.4	1.5	5.4	15.8	37.6	46.8
HRMDS0926HR	26	16.4	1.5	5.0	17.0	39.6	48.8
HRMDS0930HR	30	20.4	1.5	3.9	22.0	47.6	56.8
HRMDS0932HR	32	22.3	1.5	3.5	24.5	51.6	60.8
HRMDS0933HR	33	23.3	1.5	3.3	25.8	53.6	62.8
HRMDS0935HR	35	25.4	1.5	3.0	28.3	57.6	66.8
HRMDS0940HR	40	30.2	1.5	2.5	34.5	67.6	76.8
HRMDS0950HR	50	40.2	1.5	1.8	47.0	87.6	96.8
HRMDS1332HR	32	19.3	2	5.7	20.0	47	60
HRMDS1333HR	33	20.3	2	5.4	21.3	49	62
HRMDS1335HR	35	22.3	2	4.8	24.0	53	66
HRMDS1340HR	40	27.2	2	3.7	30.7	63	76
HRMDS1350HR	50	37	2	2.6	44.0	83	96
HRMDS1363HR	63	50	2	1.9	61.3	109	122
HRMDCM09040HR	40	30.2	1.5	2.5	34.5	67.6	76.8
HRMDCM09050HR	50	40.2	1.5	1.8	47.0	87.6	96.8
HRMDCM09063HR	63	53.1	1.5	1.4	63.3	113.6	122.8
HRMDC(M)09080HR	80	70.1	1.5	1.0	84.5	147.6	156.8
HRMDC(M)09100HR	100	90	1.5	0.8	109.5	187.6	196.8
HRMDCM13050HR	50	37	2	2.6	44.0	83	96
HRMDCM13063HR	63	50	2	1.9	61.3	109	122
HRMDC(M)13080HR	80	66.9	2	1.4	84.0	143	156
HRMDC(M)13100HR	100	86.9	2	1.0	110.7	183	196
HRMDC(M)13125HR	125	111.9	2	0.8	144.0	233	246
HRMDC(M)16080HR	80	63.3	2.5	1.4	102	138	156
HRMDC(M)16100HR	100	83.3	2.5	1	143	178	196
HRMDC(M)16125HR	125	108.3	2.5	0.7	204	228	246
HRMDC(M)16160R	160	143.3	2.5	0.5	286	298	316
HRMDC(M)16200R	200	183.3	2.5	0.3	477	378	396
HRMDC(M)16250R	250	233.3	2.5	0.2	716	478	496
HRMDC(M)16315R	315	298.3	2.5	0.1	1432	608	626

Uses



Recommended cutting condition

ISO	Workpiece	Material	Grades	Cutting speed, vc (m/min)	
P	Carbon steel	Low carbon steel	SUM22, C = 0.1~25	PC5300 280 PC5400 245	
		General carbon steel	C = 0.30~55	PC5300 255 PC5400 220	
		High carbon steel	C = 0.55~80	PC5300 240 PC5400 205	
	Low alloy steel (Alloy constituent < 5%)	-	SCM415(H), SCM420, SCM440	PC5300 195 PC5400 170	
		Hardened		PC5300 115 PC5400 100	
		High alloy steel (Alloy constituent > 5%)	Annealed	SKD61	PC5300 150 PC5400 130
	Hardened		SKH51, SKH55	PC5300 120 PC5400 105	
	M	Stainless steel	Ferritic / Martensitic	SUS410, SUS420, SUS430	PC5300 160 PC5400 135
			Austenitic	SUS303, SUS304, SUS316	PC5300 130 PC5400 110
			Duplex (Austenitic / Ferritic)	F51	PC5300 100 PC5400 85
Gray cast iron		Low tensile	GC200, GC250	PC5300 170 PC5400 150	
		High tensile	GC300, GC350	PC5300 150 PC5400 130	
K	Ductile cast iron	Ferritic	GCD400, GCD500	PC5300 170 PC5400 150	
		Pearlitic	GCD600, GCD700	PC5300 150 PC5400 130	
				PC5300 60 PC5400 50	
S	Fe Base	-	Incoloy	PC5300 55 PC5400 45	
	Ni Base	-	Inconel, Nimonic, Hastelloy	PC5300 25 PC5400 20	
	Co Base	-	Stellite	PC5300 130 PC5400 105	
	Titanium alloys	-	Pure Ti	PC5300 65 PC5400 55	
			Alloy(TiAl6V4)		

Machining example



SM45C (HRC22)

■ Cutting conditions vc = 283 m/min (1,803⁻¹)
 fz = 1.4 mm/tooth
 vf = 10,097 mm/min
 ap = 0.8 mm
 ae = 35 mm
 Coolant: Dry, Machining: Copying
 Machine: Horizontal MCT
 Overhang of tool: 250 mm

■ Tools Insert WNMX130520ZNN-MM (PC3500)
 Holder HRMDCM13050HR-4

40% Increased productivity
80% Reduced tool cost

→ In comparing HRMD with our competitor using the same cutting conditions, the cutting speed of HRMD was higher with the same depth of cut (apxae), the cycle time was reduced by 40% and the tool life was increased to over 60%. HRMD is economically more efficient due to the use of 6 cutting-edges compared to EDNW type with positive insert



STS304

■ Cutting conditions vc = 130 m/min (414⁻¹)
 fz = 1.2 mm/tooth
 vf = 2,981 mm/min
 ap = 1.0 mm, ae = 80 mm
 Coolant: Wet, Machining:
 Facing and Slotting
 Machine: Vertical MCT
 Overhang of tool: 250 mm

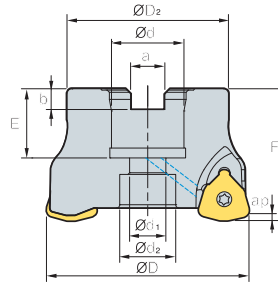
■ Tools Insert WNMX130520ZNN-MM (PC3545)
 Holder HRMDCM13100HR-6

80% Increased productivity
25% Reduced tool cost

→ In comparing HRMD with our competitor using the same cutting conditions, the cutting speed of HRMD was higher with the same depth of cut (apxae), the cycle time was reduced by 80% and the tool life was same, but HRMD is economically more efficient due to the use of 6 cutting-edges compared to SDKN type with positive insert



HRMDC(M)09



(mm)

Designation	⚙️	ØD	ØD2	Ød	Ød1	Ød2	a	b	E	F	ap	kg	Bolt	
HRMDCM	09040HR-3	3	40	34	16	9	14	8.4	5.6	19	40	1.5	0.2	SB0825
	09040HR-4	4	40	34	16	9	14	8.4	5.6	19	40	1.5	0.2	
	09050HR-4	4	50	42	22	11	18	10.4	6.3	21	40	1.5	0.3	SB1025
	09050HR-5	5	50	42	22	11	18	10.4	6.3	21	40	1.5	0.3	
	09063HR-5	5	63	49	22	11	18	10.4	6.3	21	40	1.5	0.5	SB1025
	09063HR-6	6	63	49	22	11	18	10.4	6.3	21	40	1.5	0.5	
	09080HR-6	6	80	57	27	14	20	12.4	7	23	50	1.5	1.1	SB1230
	09080HR-7	7	80	57	27	14	20	12.4	7	23	50	1.5	1.1	
09100HR-7	7	100	67	32	18	26	14.4	8	25	50	1.5	1.7	SB1630	
09100HR-8	8	100	67	32	18	26	14.4	8	25	50	1.5	1.7		
HRMDC	09080HR-6	6	80	57	25.4	14	20	9.5	6	24	50	1.5	1.1	SB1230
	09080HR-7	7	80	57	25.4	14	20	9.5	6	24	50	1.5	1.1	
	09080HR-31.75-6	6	80	67	31.75	18	26	12.7	8	32	63	1.5	1.5	SB1630
	09080HR-31.75-7	7	80	67	31.75	18	26	12.7	8	32	63	1.5	1.5	
	09100HR-7	7	100	67	31.75	18	26	12.7	8	32	63	1.5	2.1	SB1630
	09100HR-8	8	100	67	31.75	18	26	12.7	8	32	63	1.5	2.1	

Available inserts

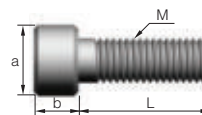


Designation	Cermet		Coated								Uncoated			page				
	CN2500	CN80	NC5330	NCM325	NCM535	NCM545	PC2505	PC2510	PC3700	PC6510	PC9530	PC9540	PC5300		PC5400	ST30A	G10	H01
WNMX	09T316ZNN-MF								●				●	●				E30
	09T316ZNN-ML												●	●				
	09T316ZNN-MM							●	●	●		●	●					

Available arbors

Designation	NC arbors	
HRMDCM	09040HR-□	BT□□-FMC16-□□ SK□□-FMC16-□□
	09050HR-□	BT□□-FMC22-□□
	09063HR-□	SK□□-FMC22-□□
	09080HR-□	BT□□-FMC27-□□ SK□□-FMC27-□□
	09100HR-□	BT□□-FMC32-□□ SK□□-FMC32-□□
	HRMDC	09080HR-□
09080HR-31.75-□		BT□□-FMA31.75-□□
09100HR-□		SK□□-FMA31.75-□□

Bolt



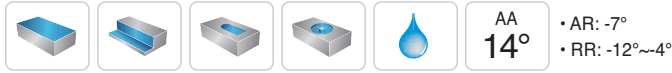
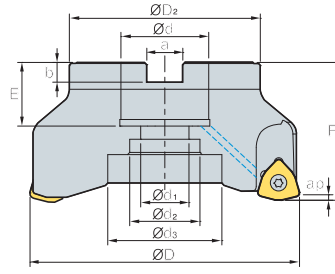
Designation	Dimensions (mm)				
	M	a	b	L	pitch
SB0825	M08	13	8	25	1.25
SB1025	M10	16	10	25	1.5
SB1230	M12	18	12	30	1.75
SB1630	M16	24	16	30	2.0

Parts

Specification	Screw	Wrench
Ø40-Ø100	FTKA0307	TW09S

Available inserts E30 Available arbors and bolt E426~E428

HRMDC(M)13



(mm)

Designation	⊙	ØD	ØD ₂	Ød	Ød ₁	Ød ₂	Ød ₃	a	b	E	F	ap	kg	Bolt	
HRMDCM	13050HR-3	3	50	42	22	11	17	-	10.4	6.3	21	40	2	0.3	SB1025
	13050HR-4	4	50	42	22	11	17	-	10.4	6.3	21	40	2	0.3	
	13063HR-4	4	63	49	22	11	18	-	10.4	6.3	21	40	2	0.5	SB1025
	13063HR-5	5	63	49	22	11	18	-	10.4	6.3	21	40	2	0.5	
	13080HR-5	5	80	57	27	14	20	-	12.4	7	23	50	2	1	SB1230
	13080HR-6	6	80	57	27	14	20	-	12.4	7	23	50	2	1	
	13100HR-6	6	100	67	32	18	26	-	14.4	8	25	50	2	1.6	SB1630
	13100HR-7	7	100	67	32	18	26	-	14.4	8	25	50	2	1.6	
13125HR-7	7	125	87	40	22	32	52	16.4	9	29	63	2	3.2	SB2040 MBA-M20	
13125HR-8	8	125	87	40	22	32	52	16.4	9	29	63	2	3.2		
HRMDC	13080HR-5	5	80	57	25.4	14	20	-	9.5	6	24	50	2	1	SB1230
	13080HR-6	6	80	57	25.4	14	20	-	9.5	6	24	50	2	1	
	13080HR-31.75-5	5	80	67	31.75	18	26	-	12.7	8	32	63	2	1.4	SB1630
	13080HR-31.75-6	6	80	67	31.75	18	26	-	12.7	8	32	63	2	1.4	
	13100HR-6	6	100	67	31.75	18	26	-	12.7	8	32	63	2	2.1	SB1630
	13100HR-7	7	100	67	31.75	18	26	-	12.7	8	32	63	2	2.1	
	13125HR-7	7	125	87	38.1	22	32	52	15.9	10	35	63	2	3.3	SB2040 MBA-M20
	13125HR-8	8	125	87	38.1	22	32	52	15.9	10	35	63	2	3.3	

Available inserts

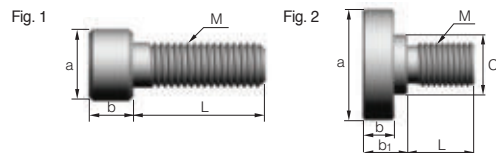


Designation	Cermet		Coated										Uncoated			page		
	CN2500	CN30	NC5330	NCM325	NCM535	NCM545	PC2505	PC2510	PC3700	PC8510	PC9530	PC9540	PC5300	PC5400	ST30A		G10	H01
WNMX 130520ZNN-MF													●	●				E30
130520ZNN-ML													●	●				
130520ZNN-MM													●	●				

Available arbors

Designation	NC arbors	
HRMDCM	13050HR-□	BT□□-FMC22-□□
		SK□□-FMC22-□□
	13063HR-□	BT□□-FMC22-□□
	13080HR-□	SK□□-FMC27-□□
		BT□□-FMC32-□□
13100HR-□	SK□□-FMC32-□□	
		BT□□-FMC40-□□
13125HR-□	SK□□-FMC40-□□	
HRMDC	13080HR-□	BT□□-FMA25.4-□□
	13080HR-31.75-□	SK□□-FMA25.4-□□
		BT□□-FMA31.75-□□
	13100HR-□	SK□□-FMA31.75-□□
		BT□□-FMA38.1-□□
13125HR-□	SK□□-FMA38.1-□□	

Bolt



Designation	Dimensions (mm)							Fig.
	M	a	b	b ₁	C	L	pitch	
SB1025	M10	16	10	-	-	25	1.5	1
SB1230	M12	18	12	-	-	30	1.75	1
SB1630	M16	24	16	-	-	30	2.0	1
SB2040	M20	30	20	-	-	40	2.5	1
MBA-M20	M20	50	14	20	27	30	2.5	2

Parts

Specification	Screw	Wrench
Ø50~Ø125	FTKA0412B	TW15S

Available inserts E30 Available arbors and bolt E426~E428



HRMDC(M)16 new

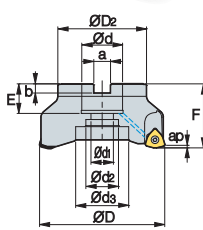


Fig. 1

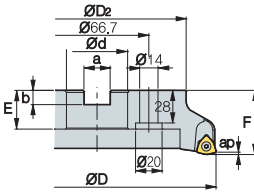


Fig. 2

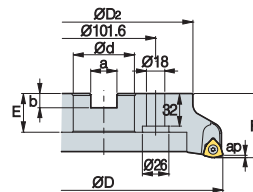


Fig. 3

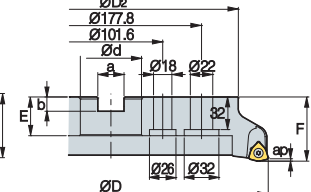


Fig. 4

AA **14°**
 • AR: -7°
 • RR: -12°~4°

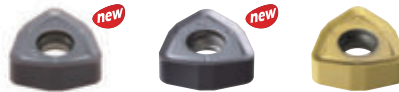
(mm)

Designation	ØD	ØD2	Ød	Ød1	Ød2	Ød3	a	b	E	F	ap	kg	Bolt	Fig.		
HRMDC (HRMDCM)	16080HR-4	4	80	65	25.4 (27)	14	20	-	9.5 (12.4)	6 (7)	25 (23)	50	2.5	0.99	SB1230	1
	16080HR-5	5	80	65	25.4 (27)	14	20	-	9.5 (12.4)	6 (7)	25 (23)	50	2.5	0.91		
	16100HR-5	5	100	85	31.75 (32)	18	26	-	12.7 (14.4)	8	33 (25)	63 (50)	2.5	1.68	SB1630	1
	16100HR-6	6	100	85	31.75 (32)	18	26	-	12.7 (14.4)	8	33 (25)	63 (50)	2.5	1.64		
	16125HR-6	6	125	100	38.1 (40)	22	32	52	15.9 (16.4)	10 (9)	36 (29)	63	2.5	3.23	SB2040	1
	16125HR-7	7	125	100	38.1 (40)	22	32	52	15.9 (16.4)	10 (9)	36 (29)	63	2.5	3.24		
	16160R-7	7	160	107	50.8 (40)	-	90	-	19 (16.4)	11 (9)	38 (32)	63	2.5	3.73	MBA-M24	2
	16160R-8	8	160	107	50.8 (40)	-	90	-	19 (16.4)	11 (9)	38 (32)	63	2.5	3.77		
	16200R-8	8	200	145	47.625 (60)	-	132	-	25.4 (25.7)	14	38	63	2.5	6.48	-	3
	16200R-10	10	200	145	47.625 (60)	-	132	-	25.4 (25.7)	14	38	63	2.5	6.61	-	3
	16250R-10	10	250	190	47.625 (60)	-	190	-	25.4 (25.7)	14	38	63	2.5	11.01	-	3
	16250R-12	12	250	190	47.625 (60)	-	190	-	25.4 (25.7)	14	38	63	2.5	11.04	-	3
	16315R-12	12	315	250	47.625 (60)	-	238	-	25.4 (25.7)	14	38	63	2.5	18.34	-	4
	16315R-14	14	315	250	47.625 (60)	-	238	-	25.4 (25.7)	14	38	63	2.5	18.35	-	4

() Metric size

Available inserts

WNMX-MF WNMX-ML WNMX-MM

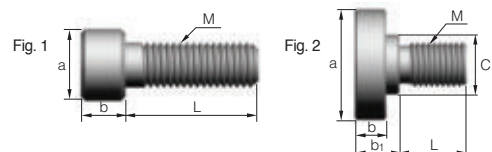


Designation	Cermet		Coated										Uncoated			page		
	CN2500	CN30	NC5330	NCM325	NCM535	NCM545	PC2505	PC2510	PC3700	PC6510	PC9530	PC9540	PC5300	PC5400	ST30A		G10	H01
WNMX 160720ZNN-MF																		E30
160720ZNN-ML													●	●				
160720ZNN-MM								●					●	●				

Available arbors

Designation	HRMDC	HRMDCM
HRMDC (HRMDCM) 16080HR-4	BT□□-FMA25.4-□□	BT□□-FMC27-□□
16080HR-5		
16100HR-5	BT□□-FMA31.75-□□	BT□□-FMC32-□□
16100HR-6		
16125HR-6	BT□□-FMA38.1-□□	BT□□-FMB40-□□
16125HR-7		
16160R-7	BT□□-FMA50.8-□□	BT□□-FMC40-□□
16160R-8		
16200R-8		
16200R-10		
16250R-10	BT□□-FMA47.625-□□	BT□□-FMB60-□□
16250R-12		
16315R-12		
16315R-14		

Bolt



Designation	Dimensions (mm)							Fig.
	M	a	b	b1	C	L	pitch	
SB1025	M10	16	10	-	-	25	1.5	1
SB1230	M12	18	12	-	-	30	1.75	1
SB1630	M16	24	16	-	-	30	2.0	1
SB2040	M20	30	20	-	-	40	2.5	1
MBA-M20	M20	50	14	20	27	30	2.5	2
MBA-M24	M24	65	14	24	37	36	3.0	2

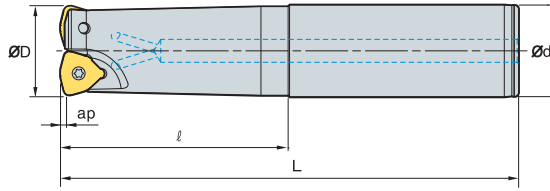
Parts

Specification	Screw	Wrench
Ø80~Ø315	FTGA0513-P	TW20-100

Available inserts E30 Available arbors and bolt E426~E428



HRMDS06 new



AA
14°

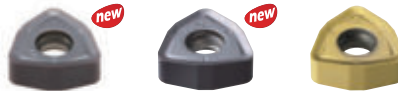
• AR: -7°
• RR: -17°~25°

(mm)

Designation	Inserts	ØD	Ød	l	L	ap	kg
HRMDS	0616HR-2S16	2	16	16	30	110	0.15
	0616HR-2M16	2	16	16	70	150	0.20
	0616HR-2L16	2	16	16	100	200	0.26
	0617HR-2S16	2	17	16	20	110	0.15
	0617HR-2M16	2	17	16	20	150	0.21
	0617HR-2L16	2	17	16	20	200	0.28
	0618HR-2S16	2	18	16	20	110	0.15
	0618HR-2M16	2	18	16	20	150	0.21
	0618HR-2L16	2	18	16	20	200	0.28
	0620HR-2S20	2	20	20	50	130	0.28
	0620HR-2M20	2	20	20	100	180	0.38
	0620HR-2L20	2	20	20	130	250	0.53
	0621HR-2S20	2	21	20	20	130	0.29
	0621HR-2M20	2	21	20	20	180	0.40
	0621HR-2L20	2	21	20	20	250	0.57
	0625HR-3S25	3	25	25	60	140	0.44
	0625HR-3M25	3	25	25	80	180	0.57
	0625HR-3L25	3	25	25	120	250	0.80
	0626HR-3S25	3	26	25	30	140	0.46
	0626HR-3M25	3	26	25	30	180	0.60
	0626HR-3L25	3	26	25	30	250	0.84
	0632HR-4S32	4	32	32	70	150	0.82
	0632HR-4M32	4	32	32	100	200	1.10
	0632HR-4L32	4	32	32	180	300	1.66
	0633HR-4S32	4	33	32	40	200	1.14
	0633HR-4M32	4	33	32	40	250	1.43
	0633HR-4L32	4	33	32	40	300	1.73

Available inserts

WNMX-MF WNMX-ML WNMX-MM



Designation	Cermet		Coated										Uncoated			page		
	CN2500	CN30	NC5330	NCM325	NCM535	NCM545	PC2505	PC2510	PC3700	PC8510	PC9530	PC9540	PC5300	PC5400	ST30A		G10	H01
WNMX 060312ZNN-MF													●	●				E30
060312ZNN-ML													●	●				
060312ZNN-MM							●	●	●				●	●				

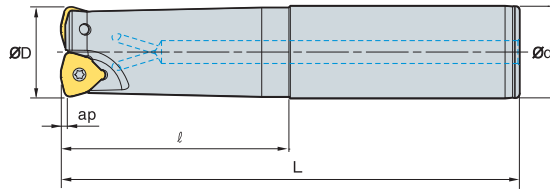
Parts

Specification	Screw	Wrench
Ø16~Ø33	ETNA02506	TW07S

Available inserts E30



HRMDS09



AA
14°
• AR: -7°
• RR: -17°~25°

(mm)

Designation		ØD	Ød	l	L	ap	
HRMDS 0925HR-2S25	2	25	25	60	140	1.5	0.5
0925HR-2M25	2	25	25	120	200	1.5	0.6
0925HR-2L25	2	25	25	180	300	1.5	1
0926HR-2S25	2	26	25	60	140	1.5	0.5
0926HR-2M25	2	26	25	60	200	1.5	0.7
0926HR-2L25	2	26	25	60	300	1.5	1
0930HR-3S32	3	30	32	70	150	1.5	0.8
0930HR-3M32	3	30	32	120	200	1.5	1
0930HR-3L32	3	30	32	180	300	1.5	1.5
0932HR-3S32	3	32	32	70	150	1.5	0.8
0932HR-3M32	3	32	32	120	200	1.5	1.1
0932HR-3L32	3	32	32	180	300	1.5	1.7
0933HR-3S32	3	33	32	70	150	1.5	0.8
0933HR-3M32	3	33	32	70	200	1.5	1.1
0933HR-3L32	3	33	32	70	300	1.5	1.7
0935HR-4S32	4	35	32	50	150	1.5	0.9
0935HR-4M32	4	35	32	50	200	1.5	1.1
0935HR-4L32	4	35	32	50	300	1.5	1.7
0940HR-4S32	4	40	32	50	150	1.5	0.9
0940HR-4M32	4	40	32	50	250	1.5	1.5
0940HR-4L32	4	40	32	50	300	1.5	1.8
0940HR-4S40	4	40	40	60	150	1.5	1.3

Available inserts

WNMX-MF WNMX-ML WNMX-MM



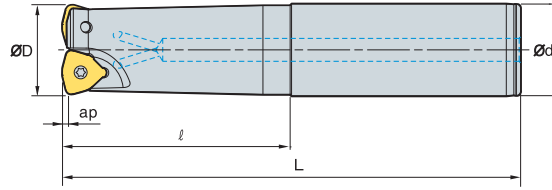
Designation	Cermet		Coated										Uncoated			page		
	CN2500	CN30	NC5330	NCM325	NCM635	NCM645	PC2505	PC2510	PC3700	PC6510	PC9530	PC9540	PC5300	PC5400	ST30A		G10	H01
WNMX 09T316ZNN-MF																		
09T316ZNN-ML								●					●	●				
09T316ZNN-MM							●	●	●		●		●	●				

Parts

Specification		
Ø25~Ø40	FTKA0307	TW09S

Available inserts E30

HRMDS09



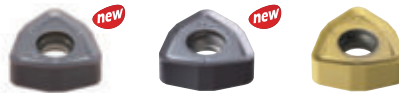
AA
14°
• AR: -7°
• RR: -17°~25°

(mm)

Designation		ØD	Ød	l	L	ap	
HRMDS 0940HR-4M40	4	40	40	130	250	1.5	2.2
0940HR-4L40	4	40	40	180	300	1.5	2.7
0940HR-4S42	4	40	42	60	150	1.5	1.4
0940HR-4M42	4	40	42	130	250	1.5	2.3
0940HR-4L42	4	40	42	180	300	1.5	2.8
0950HR-4S32	4	50	32	40	150	1.5	1.1
0950HR-4M32	4	50	32	40	250	1.5	1.6
0950HR-4L32	4	50	32	40	300	1.5	2
0950HR-4S40	4	50	40	40	150	1.5	1.4
0950HR-4M40	4	50	40	40	250	1.5	2.4
0950HR-4L40	4	50	40	40	300	1.5	2.9
0950HR-4S42	4	50	42	40	150	1.5	1.6
0950HR-4M42	4	50	42	40	250	1.5	2.6
0950HR-4L42	4	50	42	40	300	1.5	3.1
0950HR-5S32	5	50	32	40	150	1.5	1.1
0950HR-5M32	5	50	32	40	250	1.5	1.6
0950HR-5L32	5	50	32	40	300	1.5	2
0950HR-5S40	5	50	40	40	150	1.5	1.4
0950HR-5M40	5	50	40	40	250	1.5	2.4
0950HR-5L40	5	50	40	40	300	1.5	2.9
0950HR-5S42	5	50	42	40	150	1.5	1.6
0950HR-5M42	5	50	42	40	250	1.5	2.6
0950HR-5L42	5	50	42	40	300	1.5	3.1

Available inserts

WNMX-MF WNMX-ML WNMX-MM



Designation	Cermet		Coated								Uncoated			page				
	CN2500	CN30	NC5330	NCM325	NCM535	NCM545	PC2505	PC2510	PC3700	PC6510	PC9530	PC9540	PC5300		PC5400	ST30A	G10	H01
WNMX 09T316ZNN-MF									●				●	●				E30
09T316ZNN-ML													●	●				
09T316ZNN-MM							●	●	●		●		●	●				

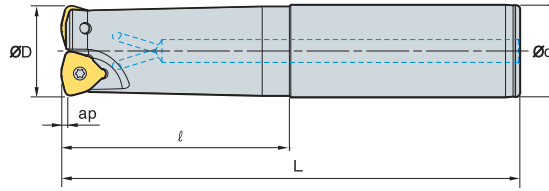
Parts

Specification		
Ø40~Ø50	FTKA0307	TW09S

Available inserts E30



HRMDS13



AA
14°

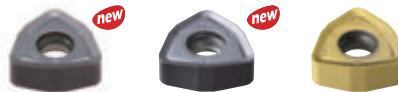
• AR: -7°
• RR: -14°~16°

(mm)

Designation		ØD	Ød	l	L	ap	
HRMDS 1332HR-2S32	2	32	32	70	150	2	0.8
1332HR-2M32	2	32	32	120	200	2	1
1332HR-2L32	2	32	32	180	300	2	1.6
1333HR-2S32	2	33	32	70	150	2	0.8
1333HR-2M32	2	33	32	70	200	2	1.1
1333HR-2L32	2	33	32	70	300	2	1.7
1335HR-2S32	2	35	32	50	150	2	0.8
1335HR-2M32	2	35	32	50	200	2	1.1
1335HR-2L32	2	35	32	50	300	2	1.7
1340HR-3S32	3	40	32	50	150	2	0.8
1340HR-3M32	3	40	32	50	250	2	1.4
1340HR-3L32	3	40	32	50	300	2	1.7
1340HR-3S40	3	40	40	60	150	2	1.2
1340HR-3M40	3	40	40	130	250	2	2.1
1340HR-3L40	3	40	40	180	300	2	2.6
1340HR-3S42	3	40	42	60	150	2	1.4
1340HR-3M42	3	40	42	130	250	2	2.3
1340HR-3L42	3	40	42	180	300	2	2.7
1350HR-3S32	3	50	32	50	150	2	1.1
1350HR-3M32	3	50	32	50	250	2	1.7
1350HR-3L32	3	50	32	50	300	2	2
1350HR-3S40	3	50	40	50	150	2	1.5
1350HR-3M40	3	50	40	50	250	2	2.4
1350HR-3L40	3	50	40	50	300	2	2.9
1350HR-3S42	3	50	42	50	150	2	1.6
1350HR-3M42	3	50	42	50	250	2	2.6
1350HR-3L42	3	50	42	50	300	2	3.1

Available inserts

WNMX-MF WNMX-ML WNMX-MM



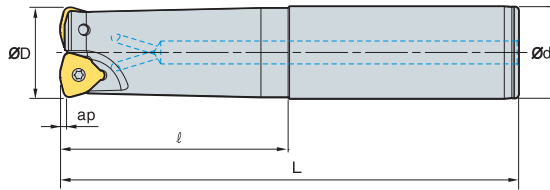
Designation	Cermet		Coated										Uncoated			page		
	CN2500	CN30	NC5330	NCM325	NCM535	NCM545	PC2505	PC2510	PC3700	PC6510	PC9530	PC9540	PC5300	PC5400	ST30A		G10	H01
WNMX 130520ZNN-MF													●	●				E30
130520ZNN-ML													●	●				
130520ZNN-MM							●	●	●		●	●	●	●				

Parts

Specification		
Ø32~Ø50	FTKA0412B	TW15S

Available inserts E30

HRMDS13



AA
14°

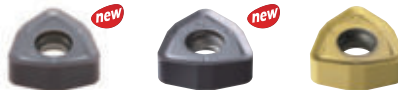
- AR: -7°
- RR: -14°~16°

(mm)

Designation		ØD	Ød	l	L	ap	
HRMDS 1350HR-4S32	4	50	32	50	150	2	1.1
1350HR-4M32	4	50	32	50	250	2	1.7
1350HR-4L32	4	50	32	50	300	2	2
1350HR-4S40	4	50	40	50	150	2	1.5
1350HR-4M40	4	50	40	50	250	2	2.4
1350HR-4L40	4	50	40	50	300	2	2.9
1350HR-4S42	4	50	42	50	150	2	1.6
1350HR-4M42	4	50	42	50	250	2	2.6
1350HR-4L42	4	50	42	50	300	2	3.1
1363HR-4S32	4	63	32	50	150	2	1.4
1363HR-4M32	4	63	32	50	250	2	2.1
1363HR-4L32	4	63	32	50	300	2	2.4
1363HR-4S40	4	63	40	50	150	2	1.8
1363HR-4M40	4	63	40	50	250	2	2.8
1363HR-4L40	4	63	40	50	300	2	3.2
1363HR-4S42	4	63	42	50	150	2	1.9
1363HR-4M42	4	63	42	50	250	2	3
1363HR-4L42	4	63	42	50	300	2	3.5
1363HR-5S32	5	63	32	50	150	2	1.5
1363HR-5M32	5	63	32	50	250	2	2
1363HR-5L32	5	63	32	50	300	2	2.3
1363HR-5S40	5	63	40	50	150	2	1.8
1363HR-5M40	5	63	40	50	250	2	2.8
1363HR-5L40	5	63	40	50	300	2	3.2
1363HR-5S42	5	63	42	50	150	2	1.9
1363HR-5M42	5	63	42	50	250	2	3
1363HR-5L42	5	63	42	50	300	2	3.5

Available inserts

WNMX-MF WNMX-ML WNMX-MM



Designation	Cermet		Coated										Uncoated			page		
	CN2500	CN30	NC5330	NCM325	NCM335	NCM345	PC2505	PC2510	PC3700	PC6510	PC9530	PC9540	PC5300	PC5400	ST30A		G10	H01
WNMX 130520ZNN-MF													●	●				E30
130520ZNN-ML													●	●				
130520ZNN-MM							●	●	●		●	●	●	●				

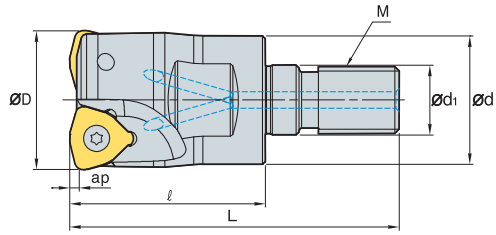
Parts

Specification		
Ø50~Ø63	FTKA0412B	TW15S

Available inserts E30



HRMDM06 new



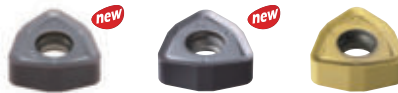
AA
14°
• AR: -7°
• RR: -18°~25°

(mm)

Designation		ØD	Ød	Ød1	ℓ	L	M	ap	
HRMDM	0616HR-M08	2	16	14.5	8.5	25	M08	1.0	0.03
	0617HR-M08	2	17	14.5	8.5	25	M08	1.0	0.03
	0618HR-M08	2	18	14.5	8.5	25	M08	1.0	0.03
	0620HR-M10	2	20	18	10.5	30	M10	1.0	0.06
	0621HR-M10	2	21	18	10.5	30	M10	1.0	0.07
	0625HR-M12	3	25	23	12.5	35	M12	1.0	0.10
	0626HR-M12	3	26	23	12.5	35	M12	1.0	0.11
	0632HR-M16	4	32	29	17	40	M16	1.0	0.21
	0633HR-M16	4	33	29	17	40	M16	1.0	0.22

Available inserts

WNMX-MF WNMX-ML WNMX-MM



Designation	Cermet		Coated										Uncoated			page		
	CN2500	CN30	NC5330	NCM325	NCM535	NCM545	PC2505	PC2510	PC3700	PC6510	PC9530	PC9540	PC5300	PC5400	ST30A		G10	H01
WNMX 060312ZNN-MF																		E30
060312ZNN-ML																		
060312ZNN-MM							●	●	●		●	●	●	●				

Available adaptor

Designation	Available adaptor
HRMDM 0616HR-M08	MAT- M08
0617HR-M08	
0618HR-M08	
0620HR-M10	MAT- M10
0621HR-M10	

Designation	Available adaptor
HRMDM 0625HR-M12	MAT- M12
0626HR-M12	
0632HR-M16	MAT- M16
0633HR-M16	

Designation : HRMDM0625HR-M12
Modular head threading measure size (M12)

II

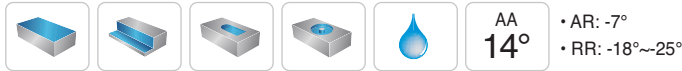
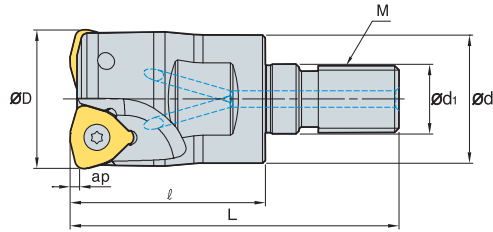
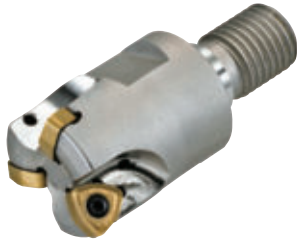
Adaptor spec.: MAT-M12-030-S25S
Adaptor threading measure (M12)

Parts

Specification		
Ø16~Ø33	ETNA02506	TW07S

Available inserts E30 Available adaptor E401~E402

HRMDM09



(mm)

Designation		ØD	Ød	Ød1	l	L	M	ap	
HRMDM	0925HR-M12	2	25	23	12.5	35	59	M12	0.10
	0926HR-M12	2	26	23	12.5	35	59	M12	0.11
	0930HR-M16	3	30	29	17	40	67	M16	0.19
	0932HR-M16	3	32	29	17	40	67	M16	0.20
	0933HR-M16	3	33	29	17	40	67	M16	0.21
	0935HR-M16	4	35	29	17	40	67	M16	0.22
	0940HR-M16	4	40	29	17	40	67	M16	0.25

Available inserts



Designation	Cermet		Coated										Uncoated			page		
	CN2500	CN30	NC5330	NCM325	NCM535	NCM545	PC2505	PC2510	PC3700	PC6510	PC9530	PC9540	PC5300	PC5400	ST30A		G10	H01
WNMX	09T316ZNN-MF																	E30
	09T316ZNN-ML							●					●	●				
	09T316ZNN-MM						●	●		●			●	●				

Available adaptor

Designation	Available adaptor	
HRMDM	0925HR-M12	MAT- M12
	0926HR-M12	
	0930HR-M16	
	0932HR-M16	
	0933HR-M16	MAT- M16
	0935HR-M16	
	0940HR-M16	

Designation : HRMDM0932HR-M16
 Modular head threading measure size (M16)

II

Adaptor spec.: MAT-M16-035-S32S
 Adaptor threading measure (M16)

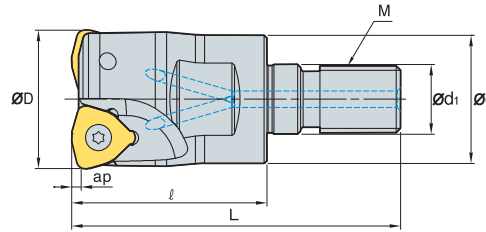
Parts

Specification		
Ø25~Ø40	FTKA0307	TW09S

Available inserts E30 Available adaptor E401~E402



HRMDM13



AA
14°

• AR: -7°
• RR: -18°~-25°

(mm)

Designation	⊙	ØD	Ød	ød1	ℓ	L	M	ap	kg	
HRMDM	1332HR-M16	2	32	29	17	40	67	M16	2	0.20
	1333HR-M16	2	33	29	17	40	67	M16	2	0.20
	1335HR-M16	2	35	29	17	40	67	M16	2	0.22
	1340HR-M16	3	40	29	17	45	72	M16	2	0.26

Available inserts



Designation	Cermet		Coated										Uncoated			page		
	CN2500	CN30	NC5330	NCM325	NCM635	NCM645	PC2505	PC2510	PC3700	PC6510	PC9530	PC9540	PC6300	PC5400	ST30A		G10	H01
WNMX	130520ZNN-MF												●	●				E30
	130520ZNN-ML												●	●				
	130520ZNN-MM						●	●	●		●	●	●	●				

Available adaptor

Designation	Available adaptor
HRMDM	MAT-M16
1332HR-M16	
1333HR-M16	
1335HR-M16	
1340HR-M16	

Designation : HRMDM1332HR-M16
Modular head threading measure size (M16)

II

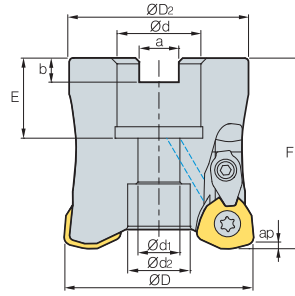
Adaptor spec.: MAT-M16-120-S32T
Adaptor threading measure (M16)

Parts

Specification		
Ø32~Ø40	FTKA0412B	TW15S

Available inserts E30 Available adaptor E401~E402

HRMC(M)13



(mm)

Designation	ØD	ØD ₂	Ød	Ød ₁	Ød ₂	a	b	E	F	ap	kg	Bolt	
HRMC 13050HR-3	3	50	47	22.225 (22)	11	16.4	8.0 (10.4)	5 (6.3)	20 (21)	50	2.0	0.4	SB1035
(HRMCM) 13050HR-4	4	50	47	22.225 (22)	11	16.4	8.0 (10.4)	5 (6.3)	20 (21)	50	2.0	0.4	SB1035
13063HR-4	4	63	60	22.225 (22)	11	17	8.0 (10.4)	5 (6.3)	20 (21)	50	2.0	0.7	SB1035
13080HR-5	5	80	76	31.75 (27)	18 (13)	26 (20)	12.7 (12.4)	8 (7)	32 (23)	70	2.0	1.6	SB16(12)45

()Metric size

Available inserts

WDKT-MH

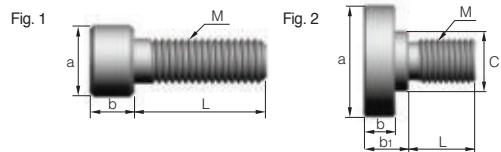


Designation	Cermet		Coated								Uncoated			page				
	CN2500	CN30	NC5330	NCM325	NCM535	NCM545	PC2505	PC2510	PC3700	PC6510	PC9530	PC9540	PC5300		PC5400	ST30A	G10	H01
WDKT 130520ZDSR-MH							●	●	●	●	●		●	●				E29

Available arbors

Designation	HRMDC	HRMDCM
HRMC 13050HR-3		
(HRMCM) 13050HR-4	BT□□-FMA22.225-□□	BT□□-FMC22-□□
13063HR-4		SK□□-FMC22-□□
13080HR-5	BT□□-FMA31.75-□□	BT□□-FMC27-□□
	SK□□-FMA31.75-□□	SK□□-FMC27-□□

Bolt



Designation	Dimensions (mm)							Fig.
	M	a	b	b ₁	C	L	pitch	
SB1035	M10	16	10	-	-	35	1.5	1
SB1245	M12	18	12	-	-	45	1.75	1
SB1645	M16	24	16	-	-	45	2.0	1
SB2040	M20	30	20	-	-	40	2.5	1
MBA-M20	M20	50	14	20	27	30	2.5	2
MBA-M24	M24	65	14	24	37	36	3.0	2

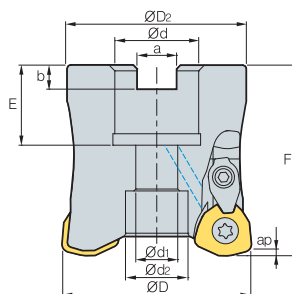
Parts

Specification	Screw	Clamp	Clamp screw	C-ring	Wrench
Ø50-Ø80	FTGA0513-P	CHH4.5R1	CTX04513H	CR03	TW20-100

Available inserts E29 Available arbors and bolt E426-E428



HRMC(M)15



(mm)

Designation		ØD	ØD	Ød	Ød1	Ød2	a	b	E	F	ap		Bolt	
HRMC	15063HR-3	3	63	60	22.225 (22)	11	17	8.0 (10.4)	5 (6.3)	20 (21)	50	2.5	0.7	SB1035
(HRMCM)	15080HR-4	4	80	76	31.75 (27)	18 (13)	26 (20)	12.7 (12.4)	8 (7)	32 (23)	70	2.5	1.7	SB16(12)45
	15100HR-5	5	100	96	31.75 (32)	18	26	12.7 (14.4)	8 (8)	32 (26)	70	2.5	2.8	SB1645
	15100HR-6	6	100	96	31.75 (32)	18	26	12.7 (14.4)	8 (8)	32 (26)	70	2.5	3.2	SB1645
	15125HR-6	6	125	98	38.1 (40)	22	32	15.9 (16.4)	10 (9)	35 (29)	63	2.5	3.3	SB2040
	15160R-7	7	160	100	50.8 (40)	-	72	19.0 (16.4)	11 (9)	38 (35)	63	2.5	4.3	MBA-M24(M20)

() Metric size

Available inserts

WDKT-MH

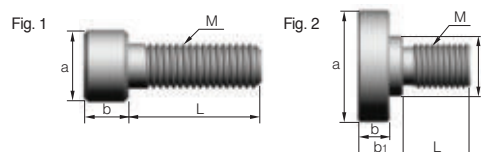


Designation	Cermet		Coated										Uncoated			page		
	CN2500	CN30	NC5330	NCM325	NCM535	NCM545	PC2505	PC2510	PC3700	PC6510	PC9530	PC9540	PC5300	PC5400	ST30A		G10	H01
WDKT 150625ZDSR-MH									●	●	●		●	●				E29

Available arbors

Designation	HRMDC	HRMDCM
HRMC		
(HRMCM)		
15063HR-3	BT□□-FMA22.225-□□	BT□□-FMC22-□□ SK□□-FMC22-□□
15080HR-4	BT□□-FMA31.75-□□ SK□□-FMA31.75-□□	BT□□-FMC27-□□ SK□□-FMC27-□□
15100HR-5		BT□□-FMC32-□□ SK□□-FMC32-□□
15100HR-6		
15125HR-6	BT□□-FMA38.1-□□ SK□□-FMA38.1-□□	BT□□-FMB40-□□ BT□□-FMC40-□□
15160R-7	BT□□-FMA50.8-□□	SK□□-FMC40-□□

Bolt



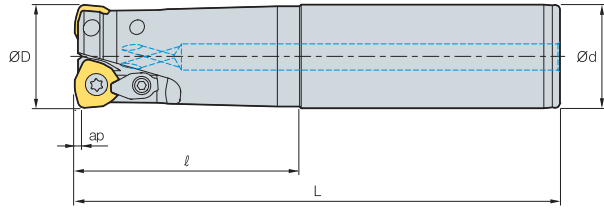
Designation	Dimensions (mm)							Fig.
	M	a	b	b ₁	C	L	pitch	
SB1035	M10	16	10	-	-	35	1.5	1
SB1245	M12	18	12	-	-	45	1.75	1
SB1645	M16	24	16	-	-	45	2.0	1
SB2040	M20	30	20	-	-	40	2.5	1
MBA-M20	M20	50	14	20	27	30	2.5	2
MBA-M24	M24	65	14	24	37	36	3.0	2

Parts

Specification					
Ø63-Ø160	FTGA0513-P	CHH5.5R1	CTX0515	CR04	TW20-100

Available inserts E29 Available arbors and bolt E426-E428

HRMS08/10



AA **15°** • AR: 7°
 • RR: -11°~5°

(mm)

Designation		ØD	Ød	ℓ	L	ap	
HRMS	0820HR-2S20	2	20	20	50	130	0.3
	0820HR-2M20	2	20	20	100	180	0.4
	0820HR-2L20	2	20	20	130	250	0.5
	0821HR-2S20	2	21	20	50	130	0.3
	0821HR-2M20	2	21	20	50	180	0.4
	0821HR-2L20	2	21	20	50	250	0.5
HRMS	1025HR-2S25	2	25	25	60	140	0.4
	1025HR-2M25	2	25	25	120	200	0.6
	1025HR-2L25	2	25	25	180	300	0.9
	1026HR-2S25	2	26	25	60	140	0.4
	1026HR-2M25	2	26	25	60	200	0.6
	1026HR-2L25	2	26	25	60	300	1.0
	1030HR-2S32	2	30	32	70	150	0.8
	1030HR-2M32	2	30	32	120	200	1.0
1030HR-2L32	2	30	32	180	300	1.5	

Available inserts

WDKT-MH



Type	Designation	Cermet		Coated										Uncoated			page		
		CN2500	CN80	NC5380	NCM325	NCM535	NCM545	PC2505	PC2510	PC3700	PC6510	PC9530	PC9540	PC5300	PC5400	ST30A		G10	H01
08 type	WDKT 080316ZDSR-MH							●	●	●	●	●	●	●	●				E29
10 type	WDKT 10T320ZDSR-MH							●	●	●	●	●	●	●	●				

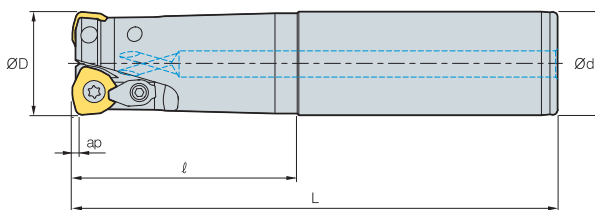
Parts

Specification					
Ø20~Ø21 (08 type)	FTNA0306	-	-	-	TW09P
Ø25~Ø30 (10 type)	FTKA0408	CHH3.5R1	CTX03510	CR03	TW15S

Available inserts E29



HRMS13



(mm)

Designation		ØD	Ød	l	L	ap	
HRMS	1332HR-2S32	2	32	32	70	150	0.8
	1332HR-2M32	2	32	32	120	200	1.0
	1332HR-2L32	2	32	32	180	300	1.6
	1333HR-2S32	2	33	32	70	150	0.8
	1333HR-2M32	2	33	32	70	200	1.1
	1333HR-2L32	2	33	32	70	300	1.7
	1335HR-2S32	2	35	32	50	150	0.8
	1335HR-2M32	2	35	32	50	200	1.1
	1335HR-2L32	2	35	32	50	300	1.7
	1340HR-3S32	3	40	32	50	150	0.8
	1340HR-3M32	3	40	32	50	250	1.4
	1340HR-3L32	3	40	32	50	300	1.7
	1340HR-3S40	3	40	40	60	150	1.2
	1340HR-3M40	3	40	40	130	250	2.1
	1340HR-3L40	3	40	40	180	300	2.6
	1340HR-3S42	3	40	42	60	150	1.4
	1340HR-3M42	3	40	42	130	250	2.3
	1340HR-3L42	3	40	42	180	300	2.7

Available inserts

WDKT-MH



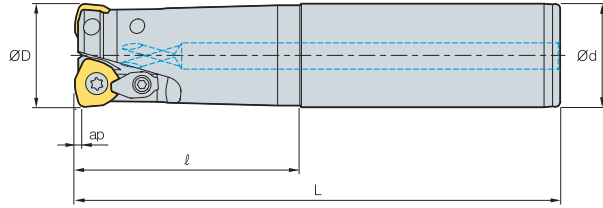
Designation	Cermet		Coated										Uncoated			page		
	CN2500	CN30	NC5330	NCM325	NCM535	NCM545	PC2505	PC2510	PC3700	PC6510	PC9530	PC9540	PC5300	PC5400	ST30A		G10	H01
WDKT 130520ZDSR-MH							●	●		●	●		●	●				E29

Parts

Specification					
Ø32,33,35	FTGA0510-P	CHH4.5R1	CTX04513H	CR03	TW20
Ø40	FTGA0512-P	CHH4.5R1	CTX04513H	CR03	TW20

Available inserts E29

HRMS15



AA
15°
• AR: 7°
• RR: -8°~6°

(mm)

Designation		ØD	Ød	l	L	ap	
HRMS	1550HR-3S32	3	50	32	50	150	1.0
	1550HR-3M32	3	50	32	50	250	1.6
	1550HR-3L32	3	50	32	50	300	1.9
	1550HR-3S40	3	50	40	50	150	1.4
	1550HR-3M40	3	50	40	50	250	2.3
	1550HR-3L40	3	50	40	50	300	2.8
	1550HR-3S42	3	50	42	50	150	1.5
	1550HR-3M42	3	50	42	50	250	2.5
	1550HR-3L42	3	50	42	50	300	3.0
	1563HR-4S32	4	63	32	50	150	1.3
	1563HR-4M32	4	63	32	50	250	1.9
	1563HR-4L32	4	63	32	50	300	2.2
	1563HR-4S40	4	63	40	50	150	1.7
	1563HR-4M40	4	63	40	50	250	2.6
	1563HR-4L40	4	63	40	50	300	3.1
	1563HR-4S42	4	63	42	50	150	1.8
	1563HR-4M42	4	63	42	50	250	2.8
	1563HR-4L42	4	63	42	50	300	3.3

Available inserts

WDKT-MH



Designation	Cermet		Coated										Uncoated			page		
	CN2500	CN30	NC5330	NCM325	NCM635	NCM645	PC2505	PC2510	PC3700	PC6510	PC9530	PC9540	PC5300	PC5400	ST30A		G10	H01
WDKT 150625ZDSR-MH								●	●	●			●	●				E29

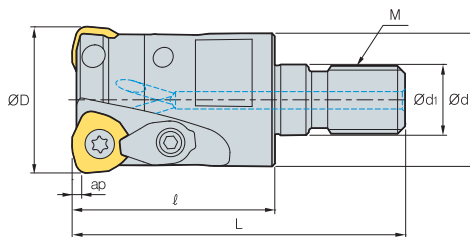
Parts

Specification					
Ø50-Ø63	FTGA0513-P	CHH5.5R1	CTX0515	CR04	TW20

Available inserts E29



HRMM08



AA
15°
• AR: 7°
• RR: -11°~5°

(mm)

Designation		ØD	Ød	Ød1	ℓ	L	M	ap		
HRMM	0820HR-M10	2	20	18	10.5	30	51	M10	1	0.06
	0821HR-M10	2	21	18	10.5	30	51	M10	1	0.06
	0825HR-M12	3	25	23	12.5	35	59	M12	1	0.11
	0826HR-M12	3	26	23	12.5	35	59	M12	1	0.11
	0828HR-M12	3	28	23	12.5	35	59	M12	1	0.12
	0832HR-M16	4	32	29	17	40	67	M16	1	0.21
	0833HR-M16	4	33	29	17	40	67	M16	1	0.21
	0835HR-M16	4	35	29	17	40	67	M16	1	0.23
	0840HR-M16	5	40	29	17	40	67	M16	1	0.25

Available inserts

WDKT-MH



Designation	Cermet		Coated										Uncoated			page		
	CN2500	CN30	NC5330	NCM325	NCM535	NCM545	PC2505	PC2510	PC3700	PC6510	PC9530	PC9540	PC5300	PC5400	ST30A		G10	H01
WDKT 080316ZDSR-MH							●	●	●	●	●		●	●				E29

Available adaptor

Designation	Available adaptor	
HRMM	0820HR-M10	MAT-M10
	0821HR-M10	
	0825HR-M12	
	0826HR-M12	MAT-M12
	0828HR-M12	
	0832HR-M16	
	0833HR-M16	MAT-M16
	0835HR-M16	
	0840HR-M16	

Designation : HRMM0820HR-M10
Modular head threading measure size (M10)

||

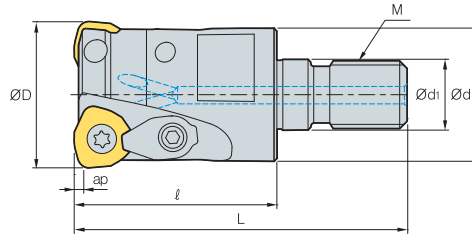
Adaptor spec.: MAT-M10-030-S20S
Adaptor threading measure (M10)

Parts

Specification						
Ø20~Ø40	FTNA0306	-	-	-	-	-

Available inserts E29 Available adaptor E401~E402

HRMM10/13



AA 15°

- AR: 7°
- RR: -11°~5°

Designation			ØD	Ød	Ød1	ℓ	L	M	ap	
HRMM	1025HR-M12	2	25	23	12.5	35	59	M12	1.5	0.1
	1026HR-M12	2	26	23	12.5	35	59	M12	1.5	0.1
	1030HR-M16	2	30	29	17	40	67	M16	1.5	0.2
	1032HR-M16	3	32	29	17	45	72	M16	1.5	0.26
	1035HR-M16	3	35	29	17	45	72	M16	1.5	0.23
	1040HR-M16	4	40	29	17	45	72	M16	1.5	0.27
HRMM	1332HR-M16	2	32	29	17	40	67	M16	2	0.17
	1333HR-M16	2	33	29	17	40	67	M16	2	0.17
	1335HR-M16	2	35	29	17	40	67	M16	2	0.19
	1340HR-M16	3	40	29	17	45	72	M16	2	0.24

Available inserts

WDKT-MH



Type	Designation	Cermet		Coated										Uncoated			page		
		CN2500	CN30	NC5330	NCM325	NCM535	NCM545	PC2505	PC2510	PC3700	PC6510	PC9530	PC9540	PC5300	PC5400	ST30A		G10	H01
10 type	WDKT 10T320ZDSR-MH								●	●	●	●		●	●				E29
13 type	WDKT 130520ZDSR-MH							●	●	●	●	●		●	●				

Available adaptor

Designation	Available adaptor
HRMM 1025HR-M12	MAT-M12
1026HR-M12	
1030HR-M16	MAT-M16
1032HR-M16	
1035HR-M16	
1040HR-M16	
1332HR-M16	MAT-M16
1333HR-M16	
1335HR-M16	
1340HR-M16	

Designation : HRMM1030HR-M16
Modular head threading measure size (M16)

||

Adaptor spec.: MAT-M16-035-S32S
Adaptor threading measure (M10)

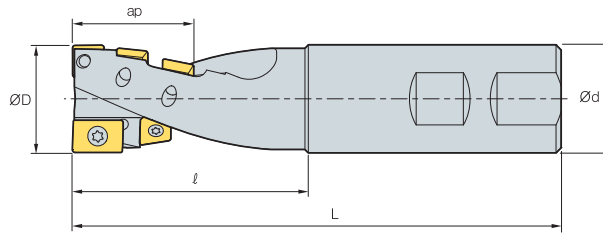
Parts

Specification						
Ø25~Ø40 (10 type)	FTKA0408	CHH3.5R1	CTX03510	CR03	TW15S	-
Ø32, 33, 35 (13 type)	FTGA0510-P	CHH4.5R1	CTX04513H	CR03	-	TW20
Ø40 (13 type)	FTGA0512-P	CHH5.5R1	CTX04513H	CR03	-	TW20

Available inserts E29 Available adaptor E401~E402



THE

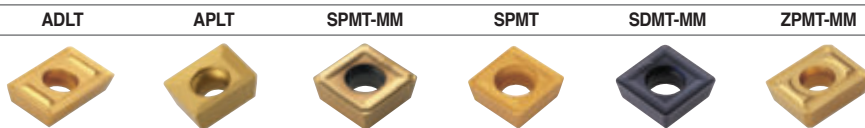


AA
90°
• AR: 5°, 10°
• RR: -5°

(mm)

Designation	ØD	Ød	ℓ	L	ap	No. of flute	kg	Available inserts		
								Lower cutting-edge	External cutting-edge	
THE	25R	25	25	55	120	25	2	0.4	APLT070304R 1z	SPMT060304 4z
	32R	32	32	70	145	40	2	0.5	ADLT150308R 1z	SDMT090308-MM 5z
	40R	40	42	88	175	54	2	1.3	ZPMT1504PPSR-MM 1z	SPMT120408-MM 5z
	50R	50	42	85	175	54	4	1.4	ZPMT1504PPSR-MM 2z	SPMT120408-MM 10z

Available inserts



Designation	Cermet		Coated										Uncoated			page			
	CN2500	CN30	NCM325	NCM335	NC5330	NCM535	NCM545	PC2505	PC2510	PC3700	PC6510	PC9530	PC9540	PC5300	PC5400		ST30A	G10	H01
SPMT 060304			●																
SDMT 090308-MM										●				●					E04
SPMT 120408-MM										●				●					E05
APLT 070304R														●					E20
ADLT 150308R			●											●					E27
ZPMT 1504PPSR-MM										●				●					E33

Recommended cutting condition

• Grooving

Workpiece	Cutting Condition		Grades
	vc (m/min)	fz (mm/t)	
P	90~140	0.05~0.2	PC5300
M	50~90	0.05~0.2	PC5300
K	70~120	0.05~0.25	PC5300

• Side cutting

Workpiece	Cutting Condition		Grades
	vc (m/min)	fz (mm/t)	
P	150~240	0.05~0.2	PC5300
M	90~150	0.05~0.2	PC5300
K	120~200	0.10~0.25	PC5300

Parts

Specification	Screw	Wrench	Wrench
Ø25	ETNA02506	TW07P	-
Ø32	ETNA0408	-	TW15S
Ø40	ETNA0511	-	TW20S
Ø50	ETNA0511	-	TW20S

Available inserts E04, E05, E20, E27, E33

E Technical Information for TP2P

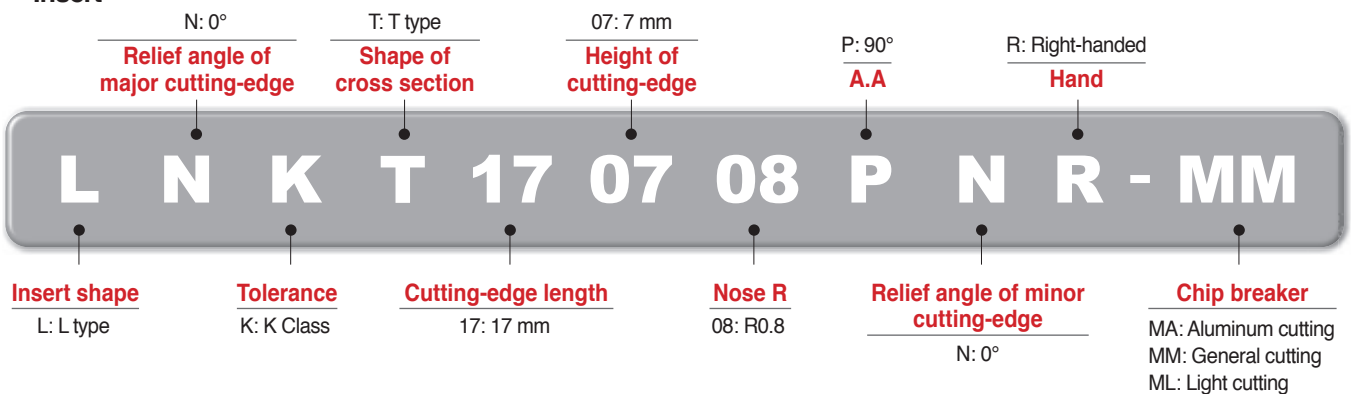
This milling tool series with its tangential clamping system increases stable machining and productivity, while improving perpendicularity

Tangen-Pro TP2P new

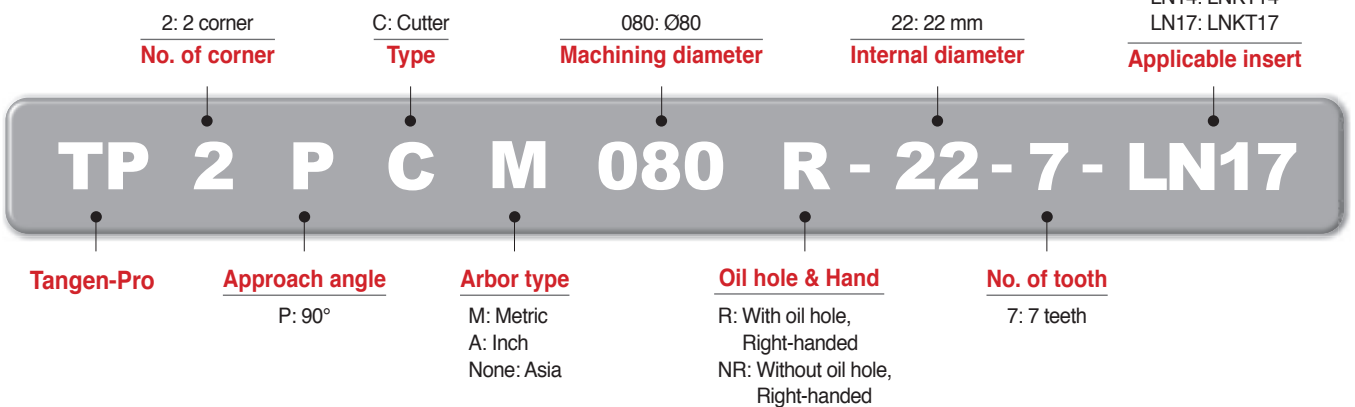
- Clamping stability gained through tangential clamping system and wedge-shaped inserts
- Excellent surface finish nearly perfect perpendicularity, and highly even flank surface compared to competitors' designs
- Improved productivity due to High-rake angles and sharp cutting-edges which lead to lower cutting resistance
→ Ideally suited for high speed and high feed machining

🔗 Code system

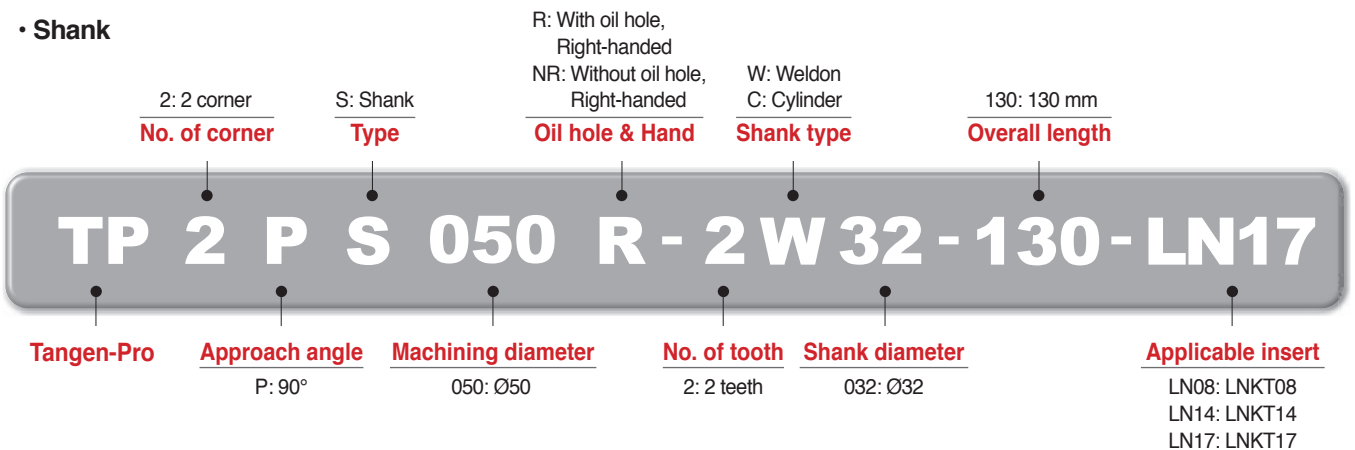
• Insert



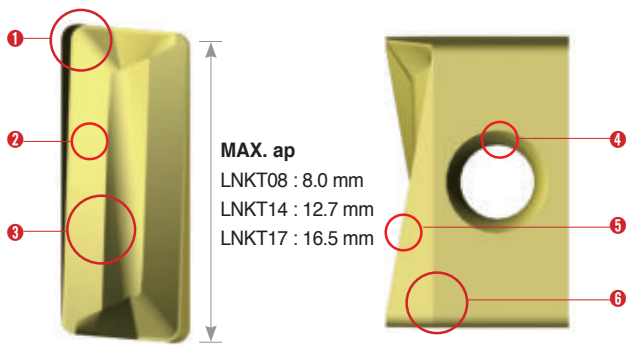
• Cutter



• Shank



Features of insert



1 Wedge type clamping area

- Clamping in wedge form on seats
→ Creates strong clamping force

2 High-rake angle chip breaker

- High-rake angle applied
- Produces smooth chip flow
→ Extended insert life

3 Convex projection

- Improved chip evacuation
- Enhances rigidity

4 Side hole (tangential type)

- Higher clamping stability

5 High-rake angle cutting-edges

- Improves cutting performance while reducing cutting load

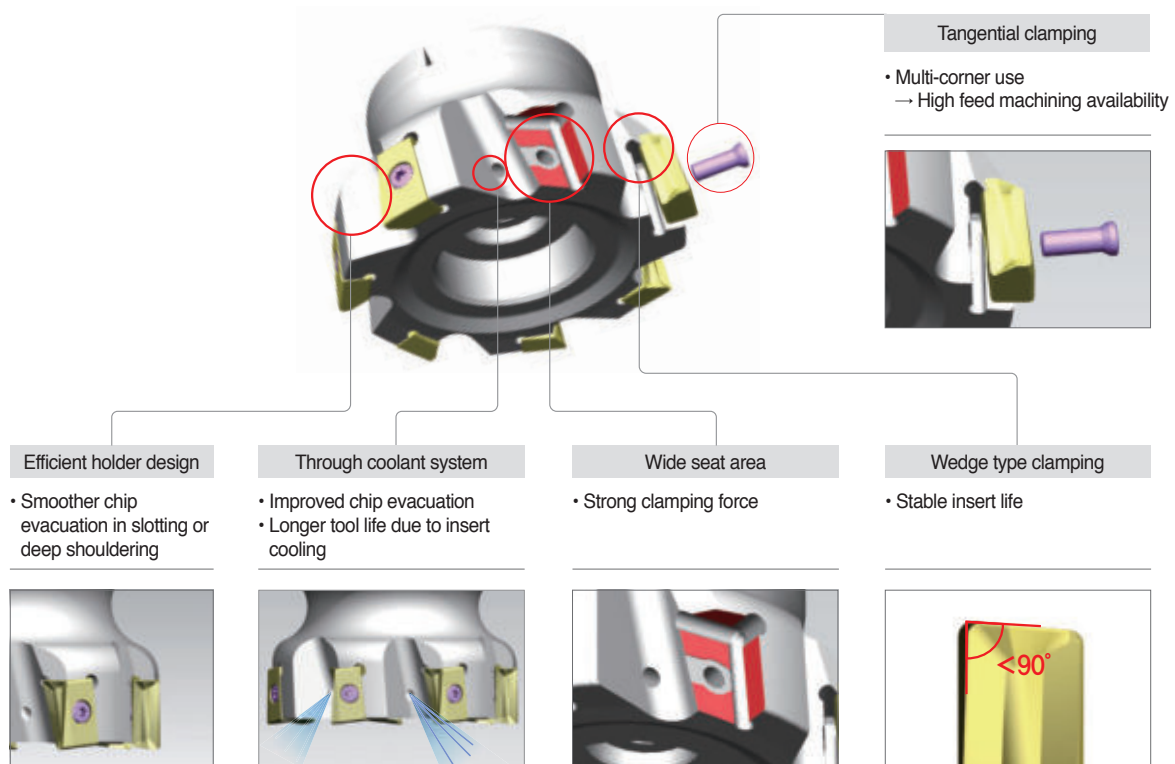
6 2-level flank relief surface

- 1st reverse positive relief surface enhances rigidity
- 2nd negative relief surface enables stable clamping
→ Improved chipping resistance and surface finish

Features of cutter

- Tangential clamping system, wedge-shaped inserts and wide seat area
→ Higher clamping stability
→ Lower vibrations and cutting resistance during machining

- Optimized H/D design with curved surface for smooth chip flow
→ Excellent chip evacuation in ramping or deep shouldering

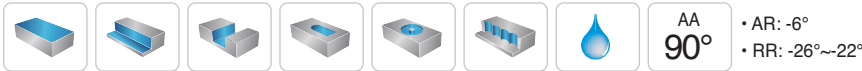
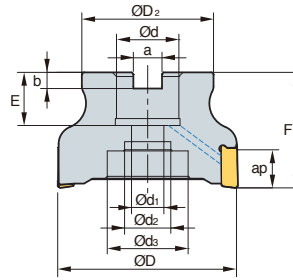


Application guideline for grade

Workpiece		P		K	N
		Carbon steel	Alloy steel	Cast iron	Aluminum
Grades	High speed cutting	PC5300	PC5300	PC6510	H01
	General cutting	PC5400	PC5300	PC6510	H01
	Interrupted cutting	PC5400	PC5400	PC5300	H01



TP2PC(M)-LN08 new



Designation		ØD	ØD ₂	Ød	Ød ₁	Ød ₂	Ød ₃	a	b	E	F	ap		
TP2PCM	040R-16-6-LN08	6	40	35	16	9	14	-	8.4	5.6	16	40	8.0	0.19
	040R-16-7-LN08	7	40	35	16	9	14	-	8.4	5.6	16	40	8.0	0.19
	050R-22-7-LN08	7	50	41	22	11	18	-	10.4	6.3	20	40	8.0	0.31
	050R-22-10-LN08	10	50	41	22	11	18	-	10.4	6.3	20	40	8.0	0.31
	063R-22-10-LN08	10	63	49	22	11	18	-	10.4	6.3	20	40	8.0	0.49
	063R-22-11-LN08	11	63	49	22	11	18	-	10.4	6.3	20	40	8.0	0.49

Available inserts



Designation	Cermet		Coated										Uncoated			page			
	CN2500	CN30	NC5330	NCM325	NCM335	NCM535	NCM545	PC2505	PC2510	PC3700	PC6510	PC9530	PC9540	PC5300	PC5400		ST30A	G10	H01
LNKT	08040PNR-MA																		E11
	080408PNR-MA																		
	080412PNR-MA																		
	080416PNR-MA																		
	080404PNR-ML																		
	080408PNR-ML																		
	080412PNR-ML																		
	080416PNR-ML																		
	080404PNR-MM																		
	080408PNR-MM																		
	080412PNR-MM																		
	080416PNR-MM																		

Available arbors

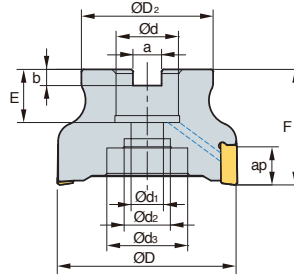
Designation	Available arbors
TP2PCM	
040R-16-6-LN08	
040R-16-7-LN08	BT□□-FMC16-□□
050R-22-7-LN08	
050R-22-10-LN08	
063R-22-10-LN08	BT□□-FMC22-□□
063R-22-11-LN08	

Parts

Specification		
Ø40~Ø63	FTKA02565S	TW07S

Available inserts E11 Available arbors and bolt E426~E428

TP2PC(M)-LN14 new



AA
90°
• AR: -6°
• RR: -22°~ -12°

(mm)

Designation	ØD	ØD2	Ød	Ød1	Ød2	Ød3	a	b	E	F	ap	kg		
TP2PCM	040R-16-4-LN14	4	40	35	16	9	14	-	8.4	5.6	19	40	12.7	0.19
	040R-16-5-LN14	5	40	35	16	9	14	-	8.4	5.6	19	40	12.7	0.19
	050R-22-5-LN14	5	50	42	22	11	18	-	10.4	6.3	20	40	12.7	0.29
	050R-22-6-LN14	6	50	42	22	11	18	-	10.4	6.3	20	40	12.7	0.29
	063R-22-6-LN14	6	63	49	22	11	18	-	10.4	6.3	20	40	12.7	0.49
	063R-22-8-LN14	8	63	49	22	11	18	-	10.4	6.3	20	40	12.7	0.49
	080R-27-7-LN14	7	80	57	27	14	20	35	12.4	7	23	50	12.7	0.94
	080R-27-10-LN14	10	80	57	27	14	20	35	12.4	7	23	50	12.7	0.94
	100R-32-8-LN14	8	100	70	32	18	28	45	14.4	8	28	63	12.7	1.73
	100R-32-13-LN14	13	100	70	32	18	28	45	14.4	8	28	63	12.7	1.73
TP2PC	125R-40-9-LN14	9	125	90	40	22	32	54	16.4	9	30	63	12.7	2.98
	125R-40-17-LN14	17	125	90	40	22	32	54	16.4	9	30	63	12.7	3.04
	080R-25.4-7-LN14	7	80	57	25.4	14	25	38	9.5	6	25	50	12.7	0.95
	080R-25.4-10-LN14	10	80	57	25.4	14	25	38	9.5	6	25	50	12.7	0.96
	100R-31.75-8-LN14	8	100	70	31.75	18	28	45	12.7	8	32	63	12.7	1.76
	100R-31.75-13-LN14	13	100	70	31.75	18	28	45	12.7	8	32	63	12.7	1.81
	125R-38.1-9-LN14	9	125	90	38.1	22	32	54	15.9	10	35	63	12.7	2.99
125R-38.1-17-LN14	17	125	90	38.1	22	32	54	15.9	10	35	63	12.7	3.07	

Available inserts

LNKT-MA LNKT-ML LNKT-MM



Designation	Cement										page	Designation	Cement										page											
	CN2500	CN30	NC5330	NCM325	NCM335	NCM535	NCM545	PC2505	PC2510	PC3700			PC6510	PC9530	PC9540	PC5300	PC5400	ST30A	H01	CN2500	CN30	NC5330		NCM325	NCM335	NCM535	NCM545	PC2505	PC2510	PC3700	PC6510	PC9530	PC9540	PC5300
LNKT 140604PNR-MA																		LNKT 140612PNR-ML																
140608PNR-MA																		140616PNR-ML																
140612PNR-MA																		140604PNR-MM																
140616PNR-MA																		140608PNR-MM																
140604PNR-ML																		140612PNR-MM																
140608PNR-ML																		140616PNR-MM																

Available arbors

Designation	Available arbors	Designation	Available arbors
TP2PCM	040R-16-4-LN14	TP2PCM	100R-32-8-LN14
	040R-16-5-LN14		100R-32-13-LN14
	050R-22-5-LN14		125R-40-9-LN14
	050R-22-6-LN14	TP2PC	125R-40-17-LN14
	063R-22-6-LN14		080R-25.4-7-LN14
	063R-22-8-LN14		080R-25.4-10-LN14
	080R-27-7-LN14		100R-31.75-8-LN14
080R-27-10-LN14	100R-31.75-13-LN14	125R-38.1-9-LN14	
	125R-38.1-17-LN14		

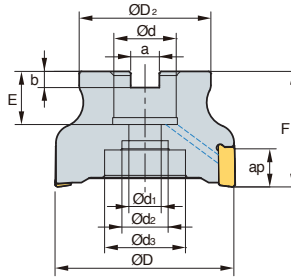
Parts

Specification	Screw	Wrench
Ø40 ~ Ø125	FTKA03510	TW15S

Available inserts E11 Available arbors and bolt E426-E428



TP2PC(M)-LN17 new



AA **90°** • AR: -6°
• RR: -21°~15°

(mm)

Designation	ØD	ØD2	Ød	Ød1	Ød2	Ød3	a	b	E	F	ap			
TP2PCM	040R-16-3-LN17	3	40	35	16	9	14	-	8.4	5.6	16	40	16.5	0.17
	040R-16-4-LN17	4	40	35	16	9	14	-	8.4	5.6	16	40	16.5	0.17
	050R-22-4-LN17	4	50	41	22	11	18	-	10.4	6.3	20	40	16.5	0.27
	050R-22-5-LN17	5	50	41	22	11	18	-	10.4	6.3	20	40	16.5	0.26
	063R-22-6-LN17	6	63	49	22	11	18	-	10.4	6.3	20	40	16.5	0.46
	063R-22-7-LN17	7	63	49	22	11	18	-	10.4	6.3	20	40	16.5	0.47
	080R-27-7-LN17	7	80	57	27	14	20	35	12.4	7	23	50	16.5	0.89
	080R-27-8-LN17	8	80	57	27	14	20	35	12.4	7	23	50	16.5	0.91
	100R-32-8-LN17	8	100	67	32	18	28	45	14.4	8	25	63	16.5	1.68
	100R-32-9-LN17	9	100	67	32	18	28	45	14.4	8	25	63	16.5	1.75
	125R-40-10-LN17	10	125	90	40	22	32	52	16.4	10	30	63	16.5	2.88
125R-40-11-LN17	11	125	90	40	22	32	52	16.4	10	30	63	16.5	2.88	
TP2PC	080R-25.4-7-LN17	7	80	57	25.4	14	20	35	9.5	6	25	50	16.5	0.92
	080R-25.4-8-LN17	8	80	57	25.4	14	20	35	9.5	6	25	50	16.5	0.93
	100R-31.75-8-LN17	8	100	67	31.75	18	28	45	12.7	8	32	63	16.5	1.73
	100R-31.75-9-LN17	9	100	67	31.75	18	28	45	12.7	8	32	63	16.5	1.73
	125R-38.1-10-LN17	10	125	90	38.1	22	32	52	15.9	9	35	63	16.5	3.06
	125R-38.1-11-LN17	11	125	90	38.1	22	32	52	15.9	9	35	63	16.5	2.91

Available inserts

LNKT-MA LNKT-ML LNKT-MM



Designation	Coated									page	Designation	Coated									page																						
	CN2500	CN30	NC5330	NCM325	NCM335	NCM335	NCM545	PC2505	PC2510			PC3700	PC6510	PC9530	PC9540	PC9530	PC9540	PC5300	PC5400	ST30A		H01																					
LNKT 170704PNR-MA 170708PNR-MA 170712PNR-MA 170716PNR-MA 170720PNR-MA 170704PNR-ML 170708PNR-ML 170712PNR-ML																					E11	LNKT 170716PNR-ML 170720PNR-ML 170704PNR-MM 170708PNR-MM 170712PNR-MM 170716PNR-MM 170720PNR-MM																					E11

Available arbors

Designation	Available arbors	Designation	Available arbors	
TP2PCM 040R-16-3-LN17 040R-16-4-LN17 050R-22-4-LN17 050R-22-5-LN17 063R-22-6-LN17 063R-22-7-LN17 080R-27-7-LN17 080R-27-8-LN17	BT□□-FMC16-□□	TP2PCM 100R-32-8-LN17 100R-32-9-LN17 125R-40-10-LN17 125R-40-11-LN17	BT□□-FMC32-□□	
	BT□□-FMC22-□□		BT□□-FMC40-□□	
	TP2PC 080R-25.4-7-LN17 080R-25.4-8-LN17 100R-31.75-8-LN17 100R-31.75-9-LN17 125R-38.1-10-LN17 125R-38.1-11-LN17		BT□□-FMC27-□□	BT□□-FMA25.4-□□
				BT□□-FMA31.75-□□
			BT□□-FMA38.1-□□	

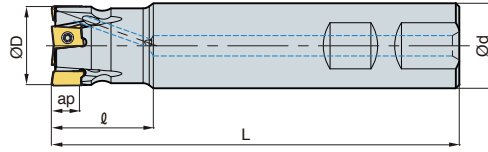
Parts

Specification		
Ø40~Ø125	FTKA0412B	TW15S

Available inserts E11 Available arbors and bolt E426~E428



TP2PS-LN08 new



AA
90°
• AR: -6°
• RR: -35°~26°

(mm)

Designation		ØD	Ød	ℓ	L	ap	
TP2PS	020R-2W20-120-LN08	2	20	20	30	120	0.25
	020R-3W20-120-LN08	3	20	20	30	120	0.25
	025R-3W25-120-LN08	3	25	25	30	120	0.39
	025R-4W25-120-LN08	4	25	25	30	120	0.39

Available inserts

LNKT-MA LNKT-ML LNKT-MM



Designation	Cermet		Coated										Uncoated			page			
	CN2500	CN30	NC5330	NCM325	NCM335	NCM535	NCM545	PC2505	PC2510	PC3700	PC6510	PC9530	PC9540	PC5300	PC5400		ST30A	G10	H01
LNKT	080404PNR-MA																		E11
	080408PNR-MA																		
	080404PNR-ML																		
	080408PNR-ML																		
	080404PNR-MM																		
	080408PNR-MM																		

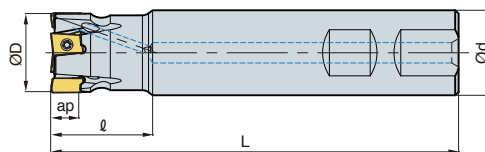
Parts

Specification		
Ø16-Ø25	FTKA02565S	TW07S

Available inserts E11



TP2PS-LN14 new



AA
90°
• AR: -6°
• RR: -21°~18°

(mm)

Designation		ØD	Ød	ℓ	L	ap	
TP2PS	025R-2W25-130-LN14	2	25	25	40	130	0.41
	032R-3W32-130-LN14	3	32	32	40	130	0.69
	040R-3W32-130-LN14	3	40	32	40	130	0.75
	040R-4W32-130-LN14	4	40	32	40	130	0.76
	050R-4W32-130-LN14	4	50	32	40	130	0.85
	050R-5W32-130-LN14	5	50	32	40	130	0.84

Available inserts

LNKT-MA LNKT-ML LNKT-MM



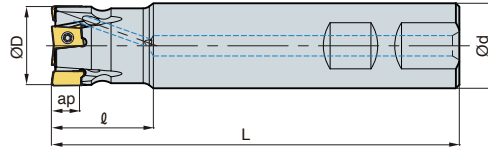
Designation	Cermet		Coated											Uncoated			page		
	CN2500	CN30	NC5330	NCM325	NCM335	NCM535	NCM545	PC2505	PC2510	PC3700	PC6510	PC9530	PC9540	PC5300	PC5400	ST30A		G10	H01
LNKT	140608PNR-MA																		E11
	140608PNR-ML																		
	140608PNR-MM																		

Parts

Specification		
Ø25 ~ Ø50	FTKA03510	TW15S

Available inserts E11

TP2PS-LN17 new



AA **90°**
 • AR: -6°
 • RR: -26°~18°

(mm)

Designation		ØD	Ød	l	L	ap		
TP2PS	032R-2W32-130-LN17	2	32	32	40	130	16.5	0.68
	032R-3W32-130-LN17	3	32	32	40	130	16.5	0.67
	040R-3W32-130-LN17	3	40	32	40	130	16.5	0.73
	040R-4W32-130-LN17	4	40	32	40	130	16.5	0.73
	050R-4W32-130-LN17	4	50	32	40	130	16.5	0.83
	050R-5W32-130-LN17	5	50	32	40	130	16.5	0.83

Available inserts



Designation	Cermet		Coated												Uncoated			page	
	CN2500	CN30	NC5330	NCM325	NCM335	NCM535	NCM545	PC2505	PC2510	PC3700	PC6510	PC9530	PC9540	PC5300	PC5400	ST30A	G10		H01
LNKT 170704PNR-MA																			E11
170708PNR-MA																			
170712PNR-MA																			
170716PNR-MA																			
170720PNR-MA																			
170704PNR-ML																			
170708PNR-ML											●			●	●				
170712PNR-ML																			
170716PNR-ML																			
170720PNR-ML																			
170704PNR-MM																			
170708PNR-MM														●	●				
170712PNR-MM																			
170716PNR-MM																			
170720PNR-MM																			

Parts

Specification		
Ø32-Ø50	FTKA0412B	TW15S

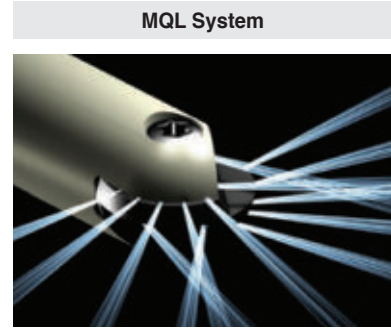
Available inserts E11



Longer tool life guaranteed thanks to the excellent cutting performance of our grades

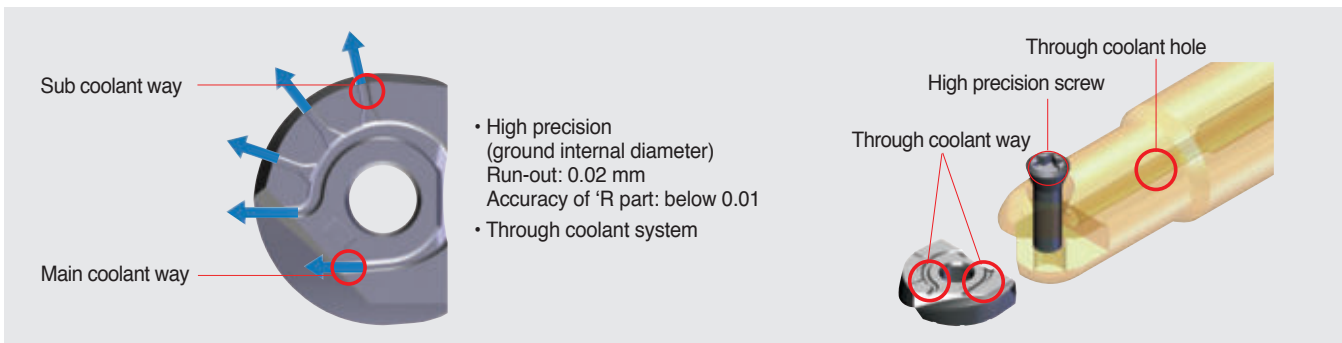
Laser Mill

- Long tool life has been achieved due to the excellent cutting performance of the insert grade
- Optimum machining of molds has been achieved with the MQL available system
- Easy clamping with simple screw on system
- Various holder line up: steel shank, carbide shank, modular type
- High accuracy indexable endmills for mold finishing



- MQL System**
- Environmental friendly system
 - Decreased coolant cost
 - Lubrication of cutting-edge
 - Improved chip control property
 - Increased tool life & improved surface quality

Clamping system



Features



- Six types of inserts are available with one holder
- Single screw for clamping of insert: Easy clamping system
- Various types of holders (Steel shank, Carbide shank, Modular type)
- MQL applicable- environmentally responsible with longer tool life & improved surface quality.

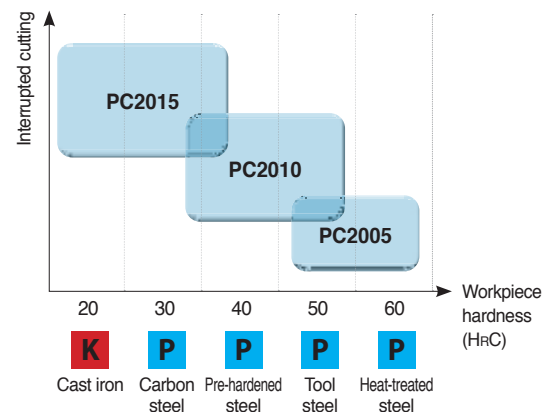
LBS, LR Order-made items

LBH-Ball	LRH-Corner radius	LFH-High feed	LCF-Chamfer	LBS-Ball type	LR-Corner R type
<ul style="list-style-type: none"> • Helical cutting-edge • Suitable for harder material with high feed 	<ul style="list-style-type: none"> • Helical cutting-edge • Variety of nose-R 	<ul style="list-style-type: none"> • Helical cutting-edge • Suitable for high feed 	<ul style="list-style-type: none"> • Straight cutting-edge • Center drilling and chamfering 	<ul style="list-style-type: none"> • Straight cutting-edge • Suitable for precise 	<ul style="list-style-type: none"> • Straight cutting-edge • Variety of nose-R

Features of Laser Mill grades

PC2005	<ul style="list-style-type: none"> • Extremely high hardness grade • The harmony between improved blade design and strong chip breaker • Optimized for machining heat-treated steel and high hardness steel
PC2010	<ul style="list-style-type: none"> • High wear resistance and excellent toughness • The harmony between excellent thermal shock resistance and strong cutting-edges. • Optimized for machining tool steel and pre-hardened steel
PC2015	<ul style="list-style-type: none"> • High welding resistance and excellent toughness • The harmony between tough grade and excellent cutting-edge design • Optimized for machining carbon steel

Application guideline per workpiece



Features of KF/KH chip breaker

- KF: Exclusive chip breaker for stable machining of carbon steel with its characteristics of high wear resistance at center part and improved blade design
- KH: Stronger insert with the combination of rake angle and relief angle that are ideal for machining high hardness workpiece

Type	Shape comparison			
Standard (For general cutting)				
	<ul style="list-style-type: none"> • Proper to general cutting • Insert shape for uniform performance 			
KH (For high hardness steel)				
	<ul style="list-style-type: none"> • Center shaper proper for machining high hardness workpiece and uniformed tool life at center part • Improved cutting-edge design by higher rake angle (α°) • Lower relief angle (β°) increases strength of cutting-edges than universal inserts. 			
KF (For carbon steel)				
	<ul style="list-style-type: none"> • Smaller chisel improves wear resistance at center for machining carbon steel. • Improved cutting-edge design by higher rake angle (α°) • Longer tool life and better cutting performance with the use of excellent blade design 			

Recommended cutting condition

Workpiece				Grades	Chip breaker	Recommended cutting conditions							
ISO	Material	HB (HRC)	vc (m/min)			fz (mm/t)	ap (mm)	ae (mm)					
K	Gray cast iron	GC250	180 (8)	PC2015	KF	130~210	0.2~0.5	0.07D	0.07D				
	Ductile cast iron	GCD600	250 (24)	PC2010									
P	Carbon steel	S20C~S50C	150	PC2005	KF	170~250	0.2~0.5	0.07D	0.07D				
	Alloy steel	SCM21~SCM5H	270 (28)	KH						130~210	0.1~0.3	0.7D	0.7D
	Pre-hardened steel	KP4M	300 (32)		PC2010 PC2015 PC210F	100~160	0.1~0.3	0.5D	0.5D				
		NIMAX	370 (40)										
		CENA1	370 (40)										
		NAK80	400 (43)										
		STAVAX	510 (52)										
High speed tool steel	SKH51~SKH59	550 (55)	PC2005 PC2010	KH	80~130	0.1~0.2	0.3D	0.3D					
Alloy tool steel	STD61 (Hot forging)	630 (60)							70~120	0.1~0.2	0.3D	0.3D	
	STD11 (Cold forging)												

Overhang	vc (m/min)	fz (mm/t)
Under 3D	100%	100%
3D~5D	70%	70%
5D~8D	60%	60%
8D~10D	50%	50%



➤ Cutting speed calculation formulas

Practical cutting speed	RPM
-------------------------	-----

$$vc_e = \frac{\pi \times D_e \times n}{1000} \text{ (m/min)}$$

$$n = \frac{vc_e \times 1000}{\pi \times D_e} \text{ (min}^{-1}\text{)}$$

Feed per tooth	Feed per minute
----------------	-----------------

$$fz = \frac{vf}{z \times n} \text{ (mm/t)}$$

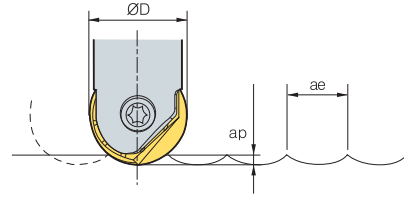
$$vf = fz \times z \times n \text{ (mm/min)}$$

Chip removal amount	Power requirement
---------------------	-------------------

$$Q = \frac{ap \times ae \times vf}{1000} \text{ (cm}^3\text{/min)}$$

$$P_{kw} = \frac{Q \times kc}{60 \times 102 \times \eta} \text{ (kW)}$$

$$P_{hp} = \frac{P_{kw}}{0.75} \text{ (hp)}$$



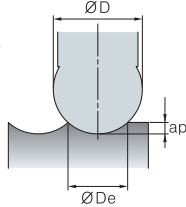
vc = Cutting speed (m/min)	Pkw = Power requirement (kW)
vc_e = Practical cutting speed (m/min)	Php = Horsepower requirement (hp)
n = Revolution per minute (min ⁻¹)	Q = Chip removal amount (cm ³ /min)
D = Cutting diameter (mm)	ap = Depth of cut (mm)
D_e = Actual diameter (mm)	ae = Width of cut (mm)
vf = Feed per minute (mm/min)	kc = Specific cutting resistance (kg/mm ²)
fz = Feed per tooth (mm/t)	η = Mechanical efficiency (%)
z = Number of tooth	

➤ Practical cutting speed calculation formulas

1. Formula of actual diameter

• Formula
: Actual diameter

$$D_e = 2 \sqrt{ap(D - ap)}$$



2. θ°Using: Calculating cutting speed at P point
(Cutting speed according to depth of cut when ramping)

• Formula
: Practical cutting speed

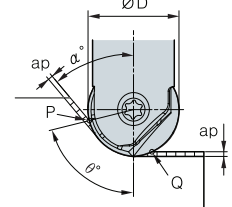
$$v_{ce} = \frac{\pi D \sin \theta \times n}{1000} \text{ (m/min)}$$

$$\theta = \cos^{-1} \left(\frac{D - 2ap}{D} \right) + (90 - \alpha^\circ)$$

3. In case of using ap: Calculating cutting speed at Q point

• Formula
: Practical cutting speed

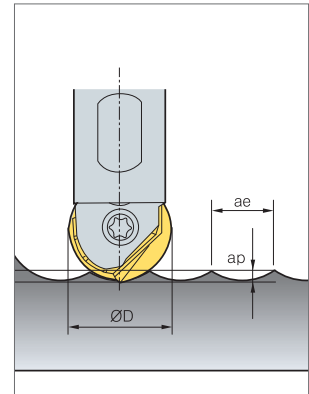
$$v_{ce} = \frac{2\pi n \sqrt{ap(D - ap)}}{1000}$$



➤ Theoretical surface roughness

		h (surface roughness) (μm)									
ae (mm)	R (mm)	0.1	0.2	0.3	0.4	0.5	0.6	0.7	0.8	0.9	1.0
5	5	0.3	1.0	2.3	4.0	6.3	9.0	12.3	16.0	20.3	25.0
6	6	0.2	0.8	1.9	3.3	5.2	7.5	10.2	13.3	16.9	20.8
8	8	0.2	0.6	1.4	2.5	3.9	5.6	7.7	10.0	12.7	15.6
10	10	0.1	0.5	1.1	2.0	3.1	4.5	6.1	8.0	10.1	12.5
12.5	12.5	0.1	0.4	0.9	1.6	2.5	3.6	4.9	6.4	8.1	10.0
15	15	0.1	0.3	0.8	1.3	2.1	3.0	4.1	5.3	6.8	8.3
16	16	0.1	0.3	0.7	1.3	2.0	2.8	3.8	5.0	6.3	7.8

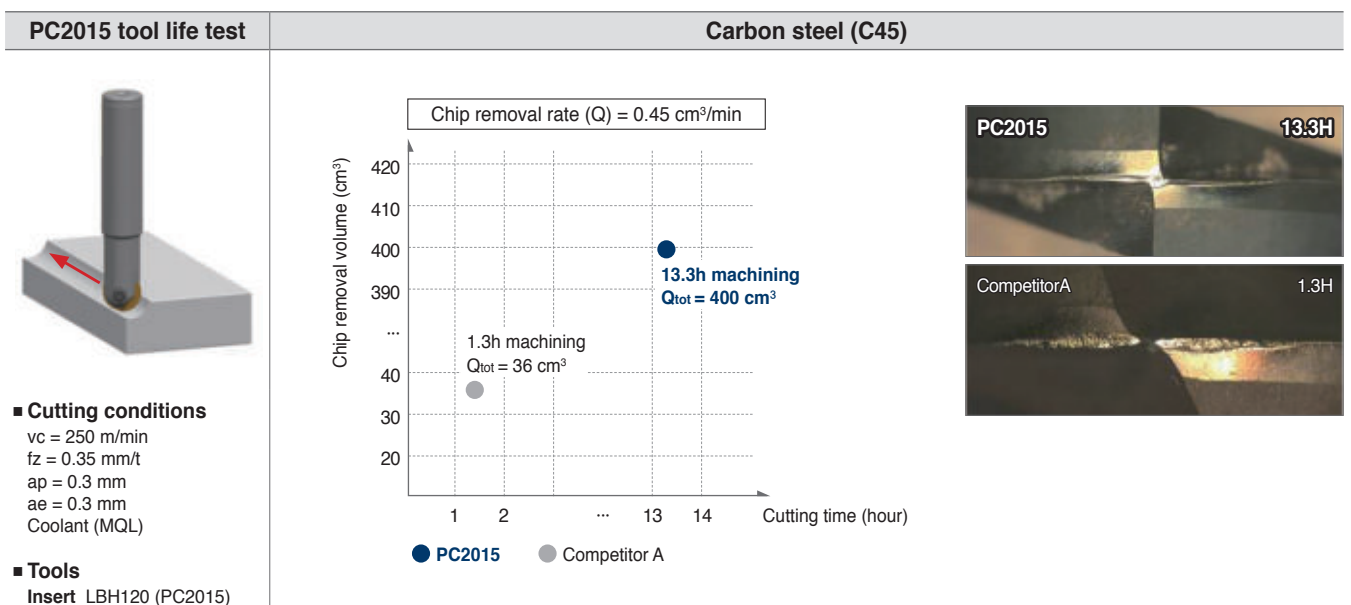
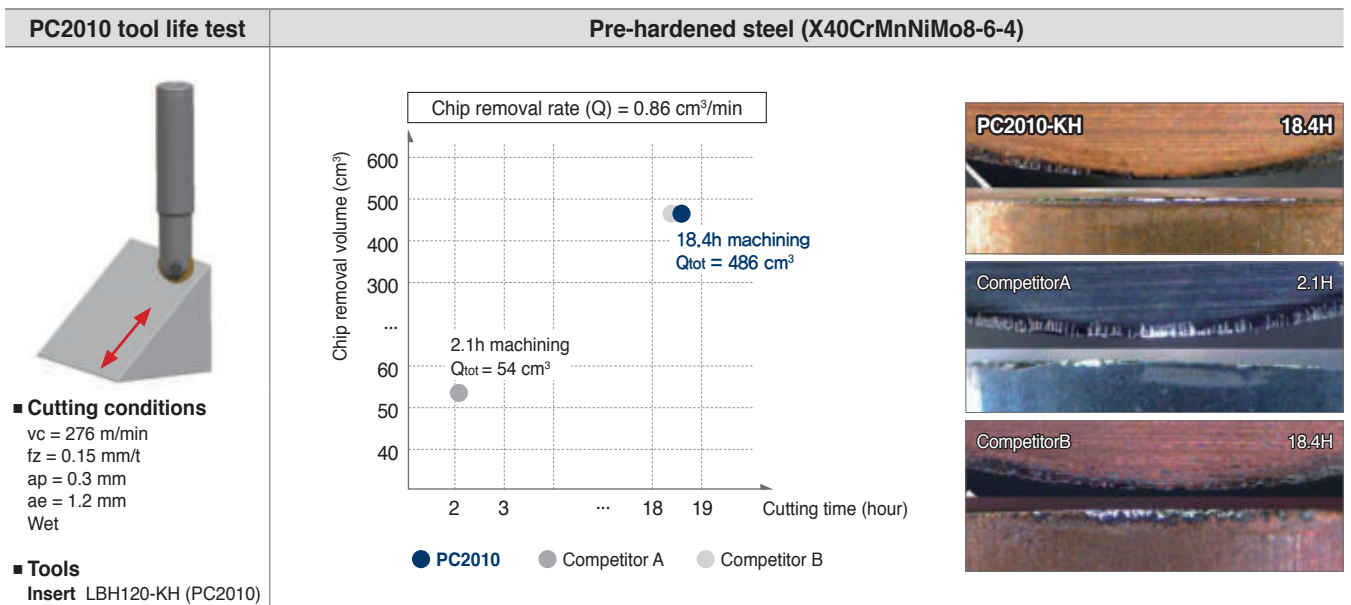
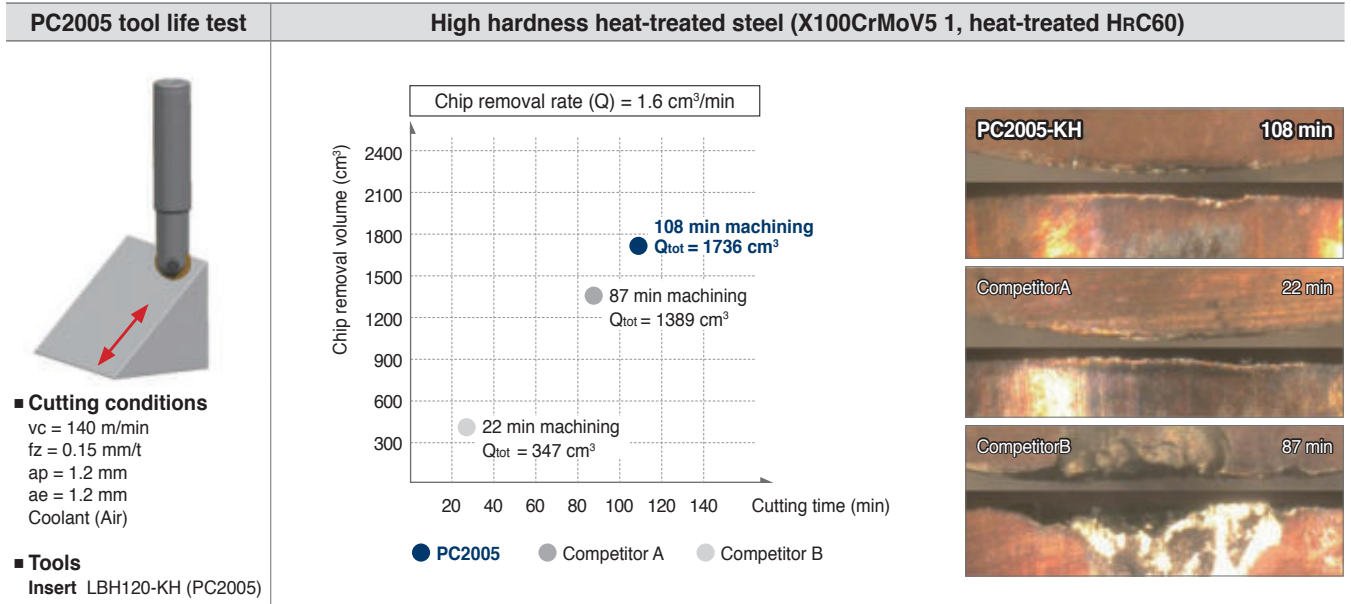
$$\text{Formula of surface roughness: } h \text{ (surface finish)} = \frac{(ae)^2}{8R} \times 1000 \text{ (}\mu\text{m)}$$



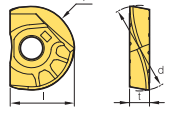
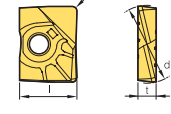
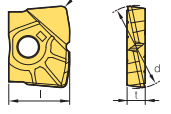
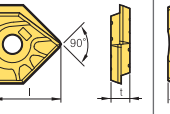
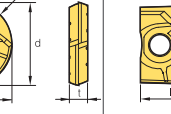
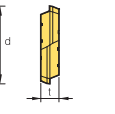
➤ Actual diameter data

ap	ØD	Ø08	Ø10	Ø12	Ø16	Ø20	Ø25	Ø30	Ø32
0.1		1.8	2.0	2.2	2.5	2.8	3.2	3.5	3.6
0.2		2.5	2.8	3.1	3.6	4.0	4.5	4.9	5.0
0.3		3.0	3.4	3.7	4.3	4.9	5.4	6.0	6.2
0.5		3.9	4.4	4.8	5.6	6.2	7.0	7.7	7.9
1.0		5.3	6.0	6.6	7.7	8.7	9.8	10.8	11.1
1.5		6.2	7.1	7.9	9.3	10.5	11.9	13.1	13.5
2.0		6.9	8.0	8.9	10.6	12.0	13.6	15.0	15.5
2.5		7.4	8.7	9.7	11.6	13.2	15.0	16.6	17.2
3.0		7.7	9.2	10.4	12.5	14.3	16.2	18.0	18.7
3.5		7.9	9.5	10.9	13.2	15.2	17.3	19.3	20.0
4.0		8.0	9.8	11.3	13.9	16.0	18.3	20.4	21.2
5.0				11.8	14.8	17.3	20.0	22.4	23.2
6.0				12.0	15.5	18.3	21.4	24.0	25.0
7.0					15.9	19.1	22.4	25.4	26.5
8.0					16.0	19.6	23.3	26.5	27.7
10.0						20.0	24.5	28.3	29.7

Performance evaluation



Available inserts

	LBH (Ball type)	LRH (Corner radius type)	LFH (High feed type)	LCF (Chamfer type)	LBS (Ball type)	LR (Corner radius type)
Holders	 R accuracy ± 0.005	 Corner R ± 0.015			 R accuracy ± 0.005	 Corner R ± 0.015
LBE080	LBH080 LBH090 LBH080-KF LBH090-KF LBH080-KH LBH090-KH				LBS080 LBS090	
LBE100 LRE100	LBH100 LBH110 LBH100-KF LBH110-KF LBH100-KH LBH110-KH	LRH100-R05 LRH100-R10 LRH110-R05 LRH100-R20	LFH100		LBS100 LBS110	LR100-R05 LR100-R20 LR100-R10 LR110-R05
LBE120 LRE120	LBH120 LBH130 LBH120-KF LBH130-KF LBH120-KH LBH130-KH	LRH120-R05 LRH120-R10 LRH130-R05 LRH120-R20	LFH120		LBS120 LBS130	LR120-R05 LR120-R20 LR120-R10 LR130-R05
LBE160 LRE160	LBH160 LBH170 LBH160-KF LBH170-KF LBH160-KH LBH170-KH	LRH160-R05 LRH160-R10 LRH170-R05 LRH160-R20 LRH160-R30	LFH160	LCF160-D90	LBS160 LBS170	LR160-R05 LR160-R30 LR160-R10 LR170-R05 LR160-R20
LBE200 LRE200	LBH200 LBH210 LBH200-KF LBH210-KF LBH200-KH LBH210-KH	LRH200-R05 LRH200-R10 LRH210-R05 LRH200-R20 LRH200-R30	LFH200	LCF200-D90	LBS200 LBS210	LR200-R05 LR200-R30 LR200-R10 LR210-R05 LR200-R20
LBE250 LRE250	LBH250 LBH260 LBH250-KF LBH260-KF LBH250-KH LBH260-KH	LRH250-R05 LRH250-R10 LRH260-R05 LRH250-R20 LRH250-R30	LFH250	LCF250-D90	LBS250 LBS260	LR250-R05 LR250-R30 LR250-R10 LR260-R05 LR250-R20
LBE300 LRE300	LBH300 LBH310 LBH300-KF LBH310-KF LBH300-KH LBH310-KH	LRH300-R10 LRH300-R20 LRH310-R05 LRH300-R30	LFH300		LBS300 LBS310	LR300-R10 LR300-R30 LR300-R20 LR310-R05
LBE320 LRE320	LBH320 LBH330 LBH320-KF LBH330-KF LBH320-KH LBH330-KH	LRH320-R10 LRH330-R10 LRH320-R20 LRH330-R20 LRH320-R30 LRH330-R30	LFH320		LBS320	LR320-R10 LR320-R30 LR320-R20

Available inserts E08~E10

* LBH for general cutting, LBH-KF for carbon steel, and LBH-KH for high hardened steel.

E Technical Information for GBE

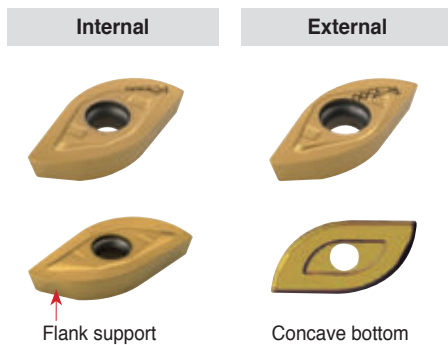
Long tool life due to high hardness grade

GBE

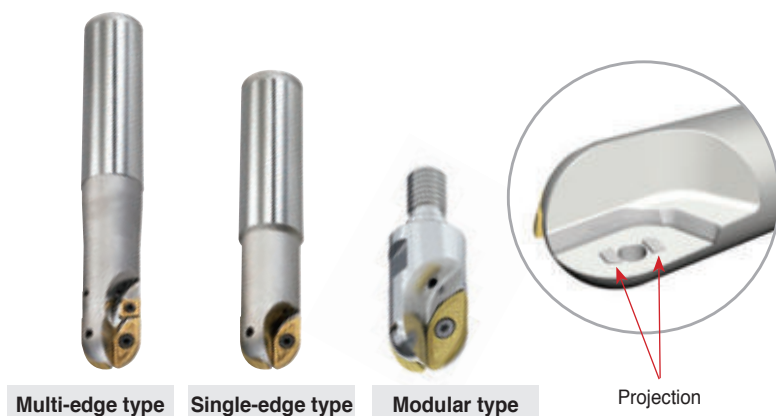
- Indexable ball nose endmill for molds in medium & roughing applications
- Long tool life with high hardness grade
- Helical high accuracy cutting-edge
- Optimized mold machining process with our internal coolant system
- Able to adjust to medium processing in middle & big roughing mold process
- Wide variety of holders in normal & long style holders

Code system

GBE	300	-	S	32
Product Name	Machining Dia.		Type	Shank Dia.
General Indexable Ball Endmill	Ø16, Ø18, Ø20, Ø22, Ø25, Ø26, Ø28, Ø30, Ø32, Ø40, Ø50		S: Standard shank L: Long shank	32: Ø32



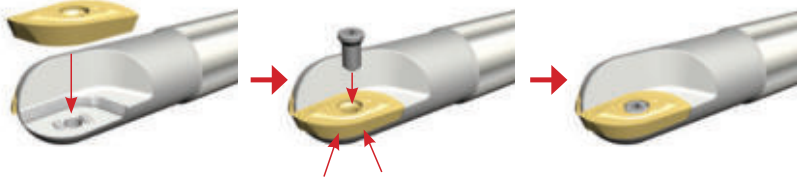
- High accuracy machining & large depth of cut applications
 - Run-out: within 0.05 mm
 - R accuracy: within 0.05 mm
- Various diameters (Ø16, Ø18, Ø20, Ø22, Ø25, Ø26, Ø28, Ø30, Ø32, Ø40, Ø50)
- Minimal cutting resistance due to Helical cutting-edge
- Anti-rotation of insert due to concave bottom & stable setting by flank support
- Long tool life & better processing due to 2 cutting inserts
- Better tool life with new grade



- Various diameters (Ø16, Ø18, Ø20, Ø22, Ø25, Ø26, Ø28, Ø30, Ø32, Ø40, Ø50)
- Improved chip treatment with internal coolant (cutting-edge portion)
- Long tool life & better processing
- Easy insert setting with projection part to prevent vibration during processing

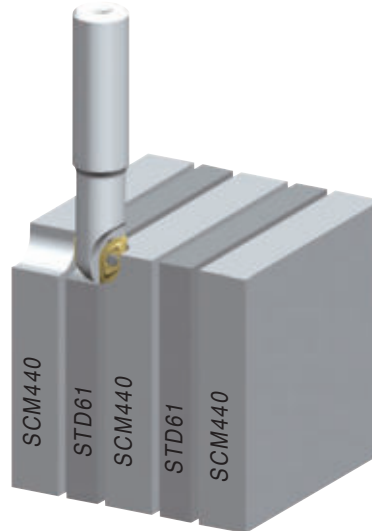
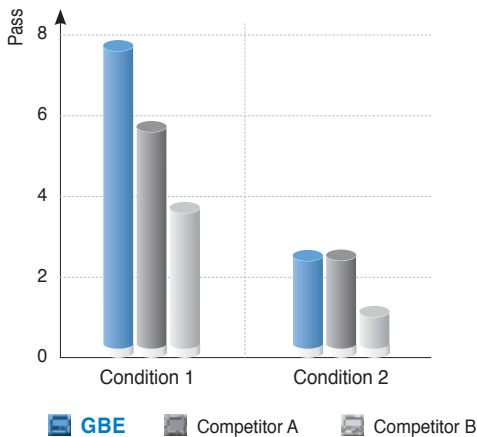


How to set insert



1. Set the insert onto the holder projection seat
2. Push the insert into the pocket as shown by red arrows and screw down with wrench

Performance evaluation



Cutting condition

Class.	Cutting speed (vc)	Feed (fz)	Depth of cut (ap)	Depth of cut (ae)	Workpiece	Etc.
Condition 1	150 m/min	0.15 mm/t	5 mm	8 mm	STD61 (HRC50) + SCM440 (HRC20)	Dry
Condition 2	100 m/min	0.1 mm/t	8 mm	8 mm		

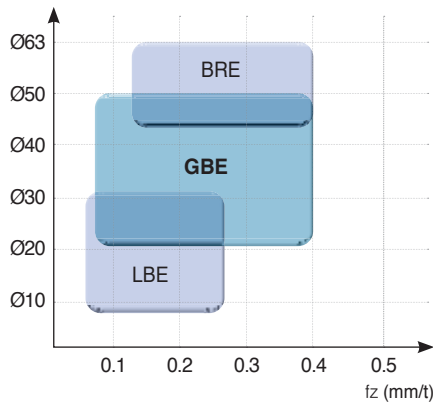
Inserts/parts

Type	Insert			Parts			
	Internal I/S	External I/S	External main I/S	Screw		Wrench	
Dia.	Internal I/S	External I/S	External main I/S	Int./Ext. type	Ext. main type	Int./Ext. type	Ext. main type
Ø16	ZPET080M-MM	ZPET080S-MM	-	FTKA02555S	-	TW08S	-
Ø18	ZPET090M-MM	ZPET090S-MM	-	FTKA0307	-	TW09S	-
Ø20	ZPET100M-MM	ZPET100S-MM	SPMT060304	FTKA0307	ETNA02506	TW09S	TW07P
Ø22	ZPET110M-MM	ZPET110S-MM	SPMT060304	FTKA0408	ETNA02506	TW15S	TW07P
Ø25	ZPET125M-MM	ZPET125S-MM	SPMT060304	FTKA0409	ETNA02506	TW15S	TW07P
Ø26	ZPET130M-MM	ZPET130S-MM	SDMT090308-MM	FTKA0409	ETNA0408	TW15S	TW15S
Ø28	ZPET140M-MM	ZPET140S-MM	SDMT090308-MM	FTGA0511-P	ETNA0408	TW20	TW15S
Ø30	ZPET150M-MM	ZPET150S-MM	SDMT090308-MM	FTGA0511-P	ETNA0408	TW20-100	TW15S
Ø32	ZPET160M-MM	ZPET160S-MM	SDMT090308-MM	FTGA0511-P	ETNA0408	TW20-100	TW15S
Ø40	ZPET200M-MM	ZPET200S-MM	SPMT120408-MM	FTGA0614	ETNA0511	TW20-100	TW20S
Ø50	ZPET250M-MM	ZPET250S-MM	SPMT120408-MM	FTGA0818	ETNA0511	TW25S	TW20S

Recommended cutting condition

Workpiece	Machining type	Hardness (HrC)	vc (m/min)	fz (mm/t)	ap (mm)	ae (mm)
Carbon, Alloy steel	Flank	Under 25	160~250	0.1~0.5	0.3~0.5D	0.2~0.3D
	Groove		120~200	0.1~0.5	0.3~0.5D	-
	Deep flank		160~250	0.1~0.5	1.0~1.5D	0.1~0.2D
Carbon, Alloy steel	Flank	Under 45	120~200	0.1~0.5	0.3~0.5D	0.2~0.3D
	Groove		120~160	0.1~0.5	0.3~0.5D	-
	Deep flank		120~200	0.1~0.5	1.0~1.5D	0.1~0.2D
Mold Alloy steel	Flank	30~40	120~200	0.1~0.3	0.3~0.5D	0.2~0.3D
	Groove		120~160	0.1~0.3	0.3~0.5D	-
	Deep flank		120~200	0.1~0.3	1.0~1.5D	0.1~0.2D
Cast iron (GC, GCD)	Flank	20~30	150~300	0.2~0.7	0.3~0.5D	0.2~0.3D
	Groove		150~300	0.2~0.7	0.3~0.5D	-
	Deep flank		150~300	0.2~0.7	1.0~1.5D	0.1~0.2D
Heat-treated steel	Flank	50~60	40~100	0.1~0.3	0.3~0.5D	0.2~0.3D
	Groove		40~100	0.1~0.3	0.3~0.5D	-
	Deep flank		40~100	0.1~0.3	1.0~1.5D	0.1~0.2D



Line-up for indexable ball endmill



Type	Application				
	Quality	Machining Efficiency	Machining Dia. Equivalence	Economical	Flank Machining with Long Edge
Laser Mill	●	○	◐	○	○
GBE	◐	●	◐	◐	●
BRE	○	●	●	●	●

●: Very Good ◐: Good ○: Normal

Test result for wear resistance

Cutting condition		Wear resistance photos				
 <p>Workpiece KP4M (HrC33), Dry</p> <p>Condition vc = 280 m/min fz = 0.25 mm/t ap = 5~10 mm ae = 5~10 mm vf = 1,486 mm/min n = 2,971 rpm</p> <p>Tool Holder GBE300-S32 Insert ZPET150M-MM (PC3700) ZPET150S-MM (PC3700)</p> <p>Cutting time : 4 Pass</p>		Top	Internal	GBE	Com.A	Com.B
			External	GBE	Com.A	Com.B
		Flank	Internal	GBE	Com.A	Com.B
			External	GBE	Com.A	Com.B
 <p>Workpiece STD11 (HrC20), Dry</p> <p>Condition vc = 250 m/min fz = 0.2 mm/t ap = 5 mm ae = 5 mm vf = 1,062 mm/min n = 2,653 rpm</p> <p>Tool Holder GBE300-S32 Insert ZPET150M-MM (PC3700) ZPET150S-MM (PC3700)</p> <p>Cutting time : 4 Pass</p>		Top	Internal	GBE	Com.A	Com.B
			External	GBE	Com.A	Com.B
		Flank	Internal	GBE	Com.A	Com.B
			External	GBE	Com.A	Com.B

Better tool life with its anti-breakage special surface treatment

BRE

- Cutting performance: Good chip control & Superior cutting performance with optimal cutting-edge line
- High rigidity body: Better tool life and special surface treatment to strengthen the holder
 - Easy to set and good durability with TCRX screw
 - Good chip control with our 3D flute design & improved external quality
- Insert: Grade available for high speed & feed applications due to its high wear and breakage resistance providing a stable cutting performance with high cutting-edge toughness and a chip breaker featuring a high rake angle

Multi-edge holder ISO View



- Good chip flow
- Good heat emission



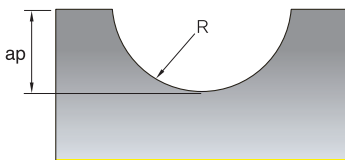
- Wider insert ensures cutting-edge strength

- Better setting force by recess



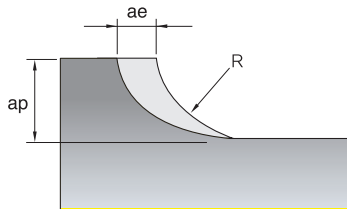
➤ BRE machining type for roughing & Recommended cutting condition

Machining type 1



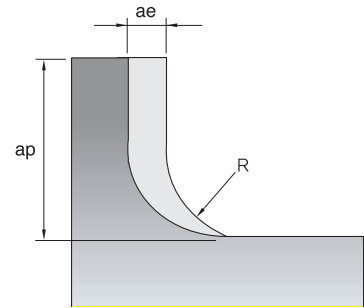
$ap = 0.3D-0.5D$

Machining type 2



$ae = 0.2D-0.3D$ $ap = 0.3D-0.5D$

Machining type 3



$ae = 0.1D-0.5D$ $ap = 1.2D-1.5D$

Workpiece	Machining type	Cutting speed (m/min)	Feed (mm/t)	Grades
Carbon/alloy steel	1	120~220	0.1~0.4	NCM325
	2	120~220	0.2~0.4	NCM325
	3	100~180	0.1~0.3	NCM325
Alloy steel	1	100~200	0.1~0.4	NCM325
	2	100~200	0.2~0.4	NCM325
	3	80~160	0.1~0.3	NCM325
Tool steel	1	80~150	0.1~0.3	NCM325
	2	80~150	0.15~0.35	NCM325
	3	60~120	0.1~0.3	NCM325
High hardness material (HrC35~45)	1	60~120	0.1~0.3	NCM325
	2	60~120	0.1~0.3	NCM325
	3	50~80	0.1~0.2	NCM325
Cast iron	1	100~180	0.2~0.5	NCM325
	2	100~180	0.2~0.5	NCM325
	3	80~160	0.15~0.4	NCM325

LBE08/10/12/16/20/25/30/32

Carbide Shank (Ball type)

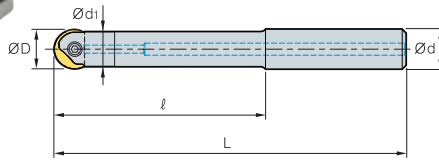


Fig. 1

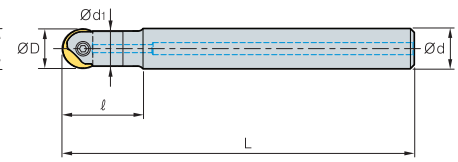


Fig. 2



(mm)

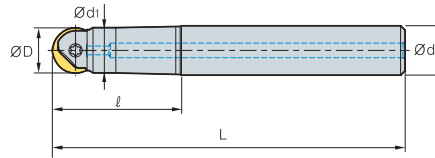
Designation	Dimensions					Parts		Available inserts (Ø)	Fig.
	ØD	Ød	Ød1	ℓ	L	Clamp screw	Wrench		
LBE 080080S-S08C	8, 9	8	7.5	80	136	ETND02506F	TWP07S	8, 9	1
	080100S-S08C	8, 9	8	7.5	100				
080020S-S08C-130	8, 9	8	7.5	20	130	ETND02506F	TWP07S	8, 9	2
080020S-S08C-150	8, 9	8	7.5	20	150				
100080S-S10C	10, 11	10	9.5	80	136	ETND0307F	TWP08S	10, 11	1
100120S-S10C	10, 11	10	9.5	120	176				
100023S-S10C-130	10, 11	10	9.5	23	130	ETND0307F	TWP08S	10, 11	2
100023S-S10C-170	10, 11	10	9.5	23	170				
120100S-S12C	12, 13	12	11.5	100	156	ETND03509	TWP10S	12, 13	1
120150S-S12C	12, 13	12	11.5	150	206				
120025S-S12C-150	12, 13	12	11.5	25	150	ETND03509	TWP10S	12, 13	2
120025S-S12C-200	12, 13	12	11.5	25	200				
160100S-S16C	16, 17	16	15.5	100	160	ETND0413	TWP15S	16, 17	1
160150S-S16C	16, 17	16	15.5	150	210				
160030S-S16C-160	16, 17	16	15.5	30	160	ETND0413	TWP15S	16, 17	2
160030S-S16C-210	16, 17	16	15.5	30	210				
200120S-S20C	20, 21	20	19.5	120	190	ETKD0516	TWP20	20, 21	1
200170S-S20C	20, 21	20	19.5	170	240				
200035S-S20C-190	20, 21	20	19.5	35	190	ETKD0516	TWP20	20, 21	2
200035S-S20C-240	20, 21	20	19.5	35	240				
250140S-S25C	25, 26	25	24.5	140	220	ETKD0620	TWP25	25, 26	1
250170S-S25C	25, 26	25	24.5	170	250				
250040S-S25C-220	25, 26	25	24.5	40	220	ETKD0620	TWP25	25, 26	2
250040S-S25C-250	25, 26	25	24.5	40	250				
300140S-S32C	30, 31	32	29.5	140	230	ETGD0825	TWP40	30, 31	1
300170S-S32C	30, 31	32	29.5	170	260				
300050S-S32C-230	30, 31	32	29.5	50	230	ETGD0825	TWP40	30, 31	2
300050S-S32C-260	30, 31	32	29.5	50	260				
320140S-S32C	32	32	31.5	140	230	ETGD0825	TWP40	32, 33	1
320170S-S32C	32	32	31.5	170	260				
320050S-S32C-230	32	32	31.5	50	230	ETGD0825	TWP40	32, 33	2
320050S-S32C-260	32	32	31.5	50	260				

Available inserts E08~E10

LBE08/10/12/16/20/25/30/32

Steel Shank (Ball type)

Taper type



(mm)

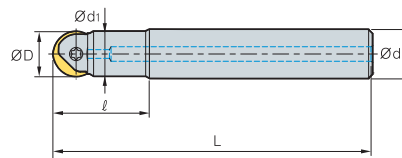
Designation	Dimensions					Parts		Available inserts (Ø)
	ØD	Ød	Ød1	ℓ	L	Clamp screw	Wrench	
LBE 080035T-S12	8, 9	12	7.5	35	91	ETND02506F	TWP07S	8, 9
080055T-S12	8, 9	12	7.5	55	111			
080075T-S12	8, 9	12	7.5	75	131			
100035T-S12	10, 11	12	9.5	35	91	ETND0307F	TWP08S	10, 11
100055T-S12	10, 11	12	9.5	55	111			
100075T-S12	10, 11	12	9.5	75	131			
120055T-S12	12, 13	12	10.4	55	111	ETND03509	TWP10S	12, 13
120085T-S16	12, 13	16	11.5	85	145			
160065T-S16	16, 17	16	14	65	125	ETND0413	TWP15S	16, 17
160100T-S20	16, 17	20	15.5	100	170			
200075T-S20	20, 21	20	17.5	75	145	ETKD0516	TWP20	20, 21
200115T-S25	20, 21	25	19.5	115	195			
250090T-S25	25, 26	25	22	90	170	ETKD0620	TWP25	25, 26
250135T-S32	25, 26	32	24.5	135	225			
300105T-S32	30, 31	32	29.5	105	195	ETGD0825	TWP40	30, 31
300160T-S32	30, 31	32	29.5	160	250			
320105T-S32	32	32	29	105	195	ETGD0825	TWP40	32, 33
320160T-S32	32	32	29	160	250			

Available inserts E08~E10

LBE12/16/20/25/30/32

Steel Shank (Ball type)

Straight type



(mm)

Designation	Dimensions					Parts		Available inserts (Ø)
	ØD	Ød	Ød1	ℓ	L	Clamp screw	Wrench	
LBE 120035S-S12	12, 13	12	11.5	35	91	ETND03509	TWP10S	12, 13
160035S-S16	16, 17	16	15.5	35	95	ETND0413	TWP15S	16, 17
200040S-S20	20, 21	20	19.5	40	110	ETKD0516	TWP20	20, 21
250045S-S25	25, 26	25	24.5	40	125	ETKD0620	TWP25	25, 26
300055S-S32	30, 31	32	29.5	55	145	ETGD0825	TWP40	30, 31
320055S-S32	32	32	31.5	55	145	ETGD0825	TWP40	32, 33

Available inserts E08~E10

LRE10/12/16/20/25/30/32

Carbide Shank (Corner R type)

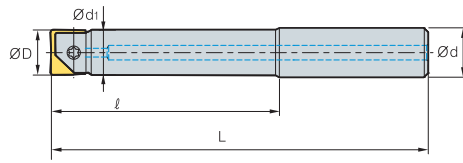


Fig. 1

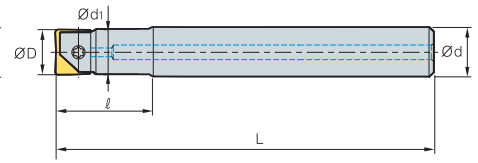


Fig. 2



(mm)

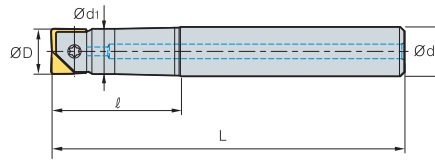
Designation	Dimensions					Parts		Available inserts (Ø)	Fig.
	ØD	Ød	Ød1	ℓ	L	Clamp screw	Wrench		
LRE 100080S-S10C	10, 11	10	9.5	80	136	ETND0307F	TWP08S	10, 11	1
	100120S-S10C	10, 11	10	9.5	120				
100023S-S10C-130	10, 11	10	9.5	23	130	ETND0307F	TWP08S	10, 11	2
100023S-S10C-170	10, 11	10	9.5	23	170				
120100S-S12C	12, 13	12	11.5	100	156	ETND03509	TWP10S	12, 13	1
120150S-S12C	12, 13	12	11.5	150	206				
120025S-S12C-150	12, 13	12	11.5	25	150	ETND03509	TWP10S	12, 13	2
120025S-S12C-200	12, 13	12	11.5	25	200				
160100S-S16C	16, 17	16	15.5	100	160	ETND0413	TWP15S	16, 17	1
160150S-S16C	16, 17	16	15.5	150	210				
160030S-S16C-160	16, 17	16	15.5	30	160	ETND0413	TWP15S	16, 17	2
160030S-S16C-210	16, 17	16	15.5	30	210				
200120S-S20C	20, 21	20	19.5	120	190	ETKD0516	TWP20	20, 21	1
200170S-S20C	20, 21	20	19.5	170	240				
200035S-S20C-190	20, 21	20	19.5	35	190	ETKD0516	TWP20	20, 21	2
200035S-S20C-240	20, 21	20	19.5	35	240				
250140S-S25C	25, 26	25	24.5	140	220	ETKD0620	TWP25	25, 26	1
250170S-S25C	25, 26	25	24.5	170	250				
250040S-S25C-220	25, 26	25	24.5	40	220	ETKD0620	TWP25	25, 26	2
250040S-S25C-250	25, 26	25	24.5	40	250				
300140S-S32C	30, 31	32	29.5	140	230	ETGD0825	TWP40	30, 31	1
300170S-S32C	30, 31	32	29.5	170	260				
300050S-S32C-230	30, 31	32	29.5	50	230	ETGD0825	TWP40	30, 31	2
300050S-S32C-260	30, 31	32	29.5	50	260				
320140S-S32C	32	32	31.5	140	230	ETGD0825	TWP40	32, 33	1
320170S-S32C	32	32	31.5	170	260				
320050S-S32C-230	32	32	31.5	50	230	ETGD0825	TWP40	32, 33	2
320050S-S32C-260	32	32	31.5	50	260				

Available inserts E08~E10

LRE10/12

Steel Shank (Corner R type)

Taper type



(mm)

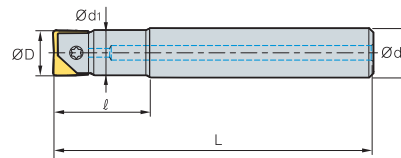
Designation	Dimensions					Parts		Available inserts (Ø)	
	ØD	Ød	Ød1	ℓ	L	Clamp screw	Wrench		
LRE	100025T-S12	10, 11	12	9.5	25	111	ETND0307F	TWP08S	10, 11
	100050T-S12	10, 11	12	9.5	50	150			
	120060T-S16	12, 13	16	11.5	60	160	ETND03509	TWP10S	12, 13

➔ Available inserts E08~E10

LRE12/16/25/30/32

Steel Shank (Corner R type)

Straight type



(mm)

Designation	Dimensions					Parts		Available inserts (Ø)	
	ØD	Ød	Ød1	ℓ	L	Clamp screw	Wrench		
LRE	120030S-S12	12, 13	12	11.5	30	111	ETND03509	TWP10S	12, 13
	160050S-S16	16, 17	16	15.5	50	131			
	160060S-S16	16, 17	16	15.5	60	160	ETND0413	TWP15S	16, 17
	200060S-S20	20, 21	20	19.5	60	145			
	200080S-S20	20, 21	20	19.5	80	180	ETKD0516	TWP20	20, 21
	250070S-S25	25, 26	25	24.5	70	145			
	250100S-S25	25, 26	25	24.5	100	225	ETKD0620	TWP25	25, 26
	300070S-S32	30, 31	32	29.5	70	160			
	300100S-S32	30, 31	32	29.5	100	225	ETGD0825	TWP40	30, 31
	320080S-S32	32	32	31.5	80	160			
320100S-S32	32	32	31.5	100	225	ETGD0825	TWP40	32, 33	

➔ Available inserts E08~E10

LBE-MHD

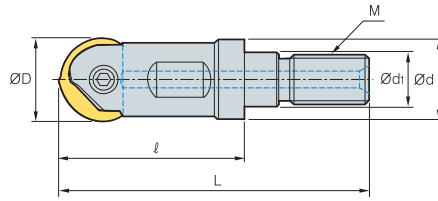


Fig. 1

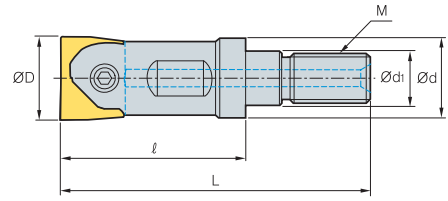


Fig. 2



(mm)

Designation	Dimensions						Parts		Available inserts (Ø)
	M	ØD	L	ℓ	Ød	Ød ₁	Clamp screw	Wrench	
LBE 100-MHD-M06	M06	10, 11	40	25	9.5	6.5	ETND0307F	TWP08S	10, 11
120-MHD-M06	M06	12, 13	40	25	11	6.5	ETND03509	TWP10S	12, 13
160-MHD-M08	M08	16, 17	47	30	14.5	8.5	ETND0413	TWP15S	16, 17
200-MHD-M10	M10	20, 21	56	35	18	10.5	ETKD0516	TWP20	20, 21
250-MHD-M12	M12	25, 26	69	45	22.5	12.5	ETKD0620	TWP25	25, 26
300-MHD-M16	M16	30, 31	77	50	28	17	ETGD0825	TWP40	30, 31
320-MHD-M16	M16	32	77	50	29	17	ETGD0825	TWP40	32, 33

Available inserts **E08~E10** Available adaptors **E401~E402**

Designation: LBE320-MHD-M16 = Adaptor spec.: MAT-M16-035-S32S
 Modular head threading measure size (M16) Adaptor threading measure (M16)

BFE



Fig. 1

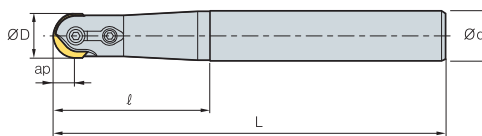


Fig. 2



Designation		ØD	Ød	ℓ	L	ap		Fig.	Available inserts
BFE	16-S	16	16	36	140	8.0	0.2	1	RC16
	16-M	16	20	65	170	8.0	0.3	2	
	16-L	16	25	65	200	8.0	0.5	2	
	20-S	20	20	45	160	10.0	0.4	1	RC20
	20-M	20	25	80	200	10.0	0.6	2	
	20-L	20	25	80	250	10.0	0.8	2	
	25-S	25	25	45	160	12.5	0.7	1	RC25
	25-M	25	32	90	210	12.5	1.1	2	
	25-L	25	32	90	300	12.5	1.7	2	
	30-S	30	32	65	175	15.0	0.9	2	RC30
	30-M	30	32	100	250	15.0	1.4	2	
	30-L	30	32	100	350	15.0	2.0	2	
32-S	32	32	56	175	16.0	0.9	1	RC32	
32-M	32	32	100	250	16.0	1.4	1		
32-L	32	32	100	350	16.0	2.0	1		

Available inserts

RC		
Designation	Coated PC210F	page
RC 16	●	E16
20	●	
25	●	
30	●	
32	●	

Recommended cutting condition

	Workpiece	Cutting condition	
		vc (m/min)	fz (mm/t)
P	General steel (SS41, SM25C) Over HB180	150 ~ 250	0.10 ~ 0.30
	Alloy steel (SM55C, SCM) Under HB300	100 ~ 200	0.10 ~ 0.20
K	Cast iron Under HB300	100 ~ 200	0.10 ~ 0.30

Parts

Specification					
	Screw	Clamp	Clamp screw	Stopper Ring	Wrench
Ø16	FTGA0513	CBH4.5R1	CTX04513	ER03	TW20
Ø20	FTGA0517	CBH4.5R2	CTX04513	ER03	TW20
Ø25	FTGA0621	CBH5R1	CTX0517	ER04	TW20
Ø30, 32	FTGA0826	CBH6R1	CTX0621	ER05	TW25

Available inserts E15

GBE (Single-edge)

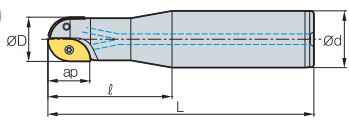


Fig. 1

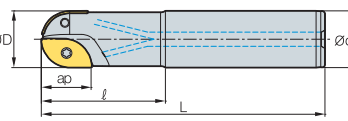


Fig. 2

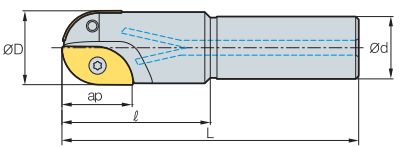


Fig. 3



(mm)

Designation	Dimensions					Available inserts		Parts		Fig.	
	ØD	Ød	ℓ	L	ap	Internal	External	Screw Int./Ext. type	Wrench Ext. main type		
GBE 160-S20	16	20	50	130	15	ZPET080M-MM	ZPET080S-MM	FTKA02555S	TW08S	1	
	160-L20	16	20	90	200	15	ZPET080M-MM	ZPET080S-MM	FTKA02555S		TW08S
	180-S20	18	20	60	130	17	ZPET090M-MM	ZPET090S-MM	FTKA0307		TW09S
	180-L20	18	20	80	200	17	ZPET090M-MM	ZPET090S-MM	FTKA0307		TW09S
	200-S25	20	25	60	140	18	ZPET100M-MM	ZPET100S-MM	FTKA0307		TW09S
	200-L25	20	25	80	250	18	ZPET100M-MM	ZPET100S-MM	FTKA0307		TW09S
	220-S25	22	25	70	140	21	ZPET110M-MM	ZPET110S-MM	FTKA0408		TW15S
	220-L25	22	25	100	250	21	ZPET110M-MM	ZPET110S-MM	FTKA0408		TW15S
	250-S32	25	32	70	150	23	ZPET125M-MM	ZPET125S-MM	FTKA0409		TW15S
	250-L32	25	32	100	300	23	ZPET125M-MM	ZPET125S-MM	FTKA0409		TW15S
	260-S32	26	32	70	150	24.5	ZPET130M-MM	ZPET130S-MM	FTKA0409		TW15S
	260-L32	26	32	100	300	24.5	ZPET130M-MM	ZPET130S-MM	FTKA0409		TW15S
	280-S32	28	32	70	150	26	ZPET140M-MM	ZPET140S-MM	FTGA0511-P		TW20
	280-L32	28	32	120	300	26	ZPET140M-MM	ZPET140S-MM	FTGA0511-P		TW20
300-S32	30	32	70	160	27	ZPET150M-MM	ZPET150S-MM	FTGA0511-P	TW20-100	2	
	300-L32	30	32	120	350	27	ZPET150M-MM	ZPET150S-MM	FTGA0511-P		TW20-100
	320-S32	32	32	70	160	28	ZPET160M-MM	ZPET160S-MM	FTGA0511-P		TW20-100
	320-L32	32	32	120	350	28	ZPET160M-MM	ZPET160S-MM	FTGA0511-P		TW20-100
400-S42	40	42	100	200	37	ZPET200M-MM	ZPET200S-MM	FTGA0614	TW20-100	3	
	400-L42	40	42	150	350	37	ZPET200M-MM	ZPET200S-MM	FTGA0614		TW20-100
500-S42	50	42	100	200	47	ZPET250M-MM	ZPET250S-MM	FTGA0818	TW25-100	3	
	500-L42	50	42	100	350	47	ZPET250M-MM	ZPET250S-MM	FTGA0818		TW25-100

Available inserts E33



GBE-M (Multi-edge)

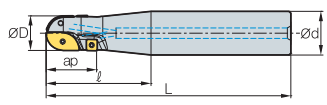


Fig. 1

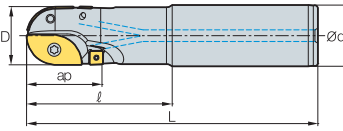


Fig. 2

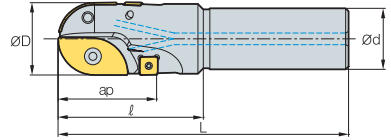


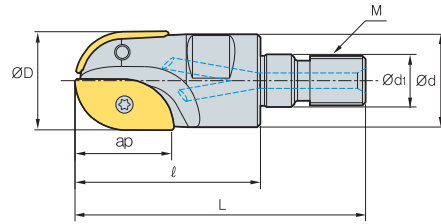
Fig. 3



Designation	Dimensions					Available inserts			Parts				Fig.	
	ØD	Ød	l	L	ap	Internal	External	Ext. main	Screw		Wrench			
									Int./Ext. type	Ext. main type	Int./Ext. type	Ext. main type		
GBE 200M-S25	20	25	70	150	28	ZPET100M-MM	ZPET100S-MM	SPMT060304	FTKA0307	ETNA02506	TW09S	TW07P	1	
200M-L25	20	25	70	250	28	ZPET100M-MM	ZPET100S-MM	SPMT060304	FTKA0307	ETNA02506	TW09S	TW07P		
220M-S25	22	25	80	150	31	ZPET110M-MM	ZPET110S-MM	SPMT060304	FTKA0408	ETNA02506	TW15S	TW07P		
220M-L25	22	25	80	250	31	ZPET110M-MM	ZPET110S-MM	SPMT060304	FTKA0408	ETNA02506	TW15S	TW07P		
250M-S32	25	32	80	180	33	ZPET125M-MM	ZPET125S-MM	SPMT060304	FTKA0409	ETNA02506	TW15S	TW07P		
250M-L32	25	32	80	300	33	ZPET125M-MM	ZPET125S-MM	SPMT060304	FTKA0409	ETNA02506	TW15S	TW07P		
260M-S32	26	32	80	180	39	ZPET130M-MM	ZPET130S-MM	SDMT090308-MM	FTGA0409	ETNA0408	TW15S	TW15S		
260M-L32	26	32	80	300	39	ZPET130M-MM	ZPET130S-MM	SDMT090308-MM	FTGA0409	ETNA0408	TW15S	TW15S		
280M-S32	28	32	80	180	41	ZPET140M-MM	ZPET140S-MM	SDMT090308-MM	FTGA0511-P	ETNA0408	TW20	TW15S		
280M-L32	28	32	80	300	41	ZPET140M-MM	ZPET140S-MM	SDMT090308-MM	FTGA0511-P	ETNA0408	TW20	TW15S		
300M-S32	30	32	100	200	41	ZPET150M-MM	ZPET150S-MM	SDMT090308-MM	FTGA0511-P	ETNA0408	TW20-100	TW15S		
300M-L32	30	32	100	350	41	ZPET150M-MM	ZPET150S-MM	SDMT090308-MM	FTGA0511-P	ETNA0408	TW20-100	TW15S		
320M-S32	32	32	100	200	42	ZPET160M-MM	ZPET160S-MM	SDMT090308-MM	FTGA0511-P	ETNA0408	TW20-100	TW15S		2
320M-L32	32	32	100	350	42	ZPET160M-MM	ZPET160S-MM	SDMT090308-MM	FTGA0511-P	ETNA0408	TW20-100	TW15S		
400M-S42	40	42	100	200	56	ZPET200M-MM	ZPET200S-MM	SPMT120408-MM	FTGA0614	ETNA0511	TW20-100	TW20S	3	
400M-L42	40	42	100	350	56	ZPET200M-MM	ZPET200S-MM	SPMT120408-MM	FTGA0614	ETNA0511	TW20-100	TW20S		
500M-S42	50	42	100	200	67	ZPET250M-MM	ZPET250S-MM	SPMT120408-MM	FTGA0818	ETNA0511	TW25-100	TW20S	3	
500M-L42	50	42	100	350	67	ZPET250M-MM	ZPET250S-MM	SPMT120408-MM	FTGA0818	ETNA0511	TW25-100	TW20S		

➔ Available inserts E20, E27, E33

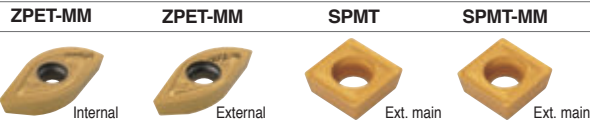
GBEM



(mm)

Designation	Dimensions							Available inserts		
	ØD	Ød	Ød ₁	ℓ	L	M	ap	Internal	External	
GBEM	160-M08	16	15	8.5	30	47	M08	15	ZPET080M-MM	ZPET080S-MM
	200-M10	20	18.6	10.5	35	56	M10	18	ZPET100M-MM	ZPET100S-MM
	250-M12	25	23.2	12.5	45	69	M12	23	ZPET125M-MM	ZPET125S-MM
	300-M16	30	27.8	17	50	77	M16	27	ZPET150M-MM	ZPET150S-MM
	320-M16	32	29.8	17	50	77	M16	28	ZPET160M-MM	ZPET160S-MM

Available inserts



Designation	Coated				page	Designation	Coated				page	
	NCM325	PC2510	PC3700	PC5300			NCM325	PC2510	PC3700	PC5300		
SPMT	060304	●			E27	ZPET	080S-MM				E33	
	120408-MM		●	●			090S-MM					
SDMT	090308-MM			●	E20	100S-MM		●	●	●		
ZPET	080M-MM				E33	110S-MM						
	090M-MM					125S-MM		●	●	●		
	100M-MM		●	●		●	130S-MM					
	110M-MM						140S-MM					
	125M-MM		●	●		●	150S-MM			●		●
	130M-MM						160S-MM		●	●		●
	140M-MM						200S-MM			●		
	150M-MM			●		●	250S-MM					
	160M-MM		●	●		●						
	200M-MM			●								
250M-MM												

Parts

Specification	Screw		Wrench	
	Int./Ext. type	Ext. main type	Int./Ext. type	Ext. main type
Ø16	FTKA02555S	-	TW08S	-
Ø18, Ø20	FTKA0307	ETNA02506	TW09S	TW07P
Ø22				
Ø25	FTKA0409	ETNA02506	TW15S	TW07P
Ø30	FTGA0511-P	ETNA0408	TW20-100	TW15S
Ø32	FTGA0511-P	ETNA0408	TW20-100	TW15S

Designation: GBEM320-M16
Modular head threading measure size (M16)

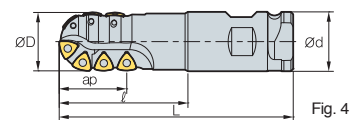
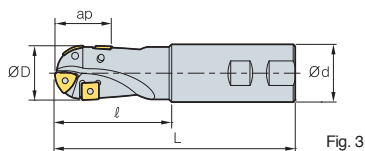
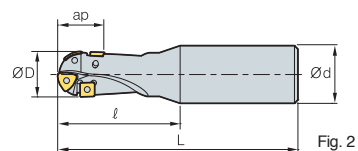
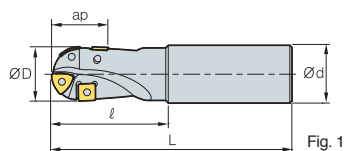
II

Adaptor spec.: MAT-M16-035-S32S
Adaptor threading measure (M16)

Available inserts E20, E27, E33 Available adaptors E401~E402



BRE



- AR: 0°~10°
- RR: -3°~0°

(mm)

Designation	Dimensions					Available inserts		Parts		Fig.		
	ØD	Ød	ℓ	L	ap	Internal	External	Screw	Wrench			
BRE 20R-S	20	20	50	125	20	ZDMT080310R-MM	SPMT060304	ETNA02506	TW07P	0.25	1	
	20R-M	20	20	75	150					0.31		
	20R-L	20	25	100	200					0.57		2
	20R-SL	20	25	65	125					0.33		
25R-S	25	25	70	150	23	ZDMT110312.5R-MM	SPMT060304	ETNA02506	TW07P	0.47	1	
	25R-M	25	25	95	175					0.56		
	25R-L	25	32	100	200					0.92		2
	25R-SL	25	25	75	135					0.41		
32R-S	32	32	85	175	31	ZDMT130416R-MM	SDMT090308-MM	ETNA0408	TW15S	0.87	1	
	32R-M	32	32	100	200					1.02		
	32R-L	32	32	150	250					1.3		3
	32R-SL	32	32	75	150					0.71		




Available inserts

SPMT ZDMT-R-MM



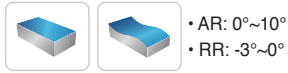
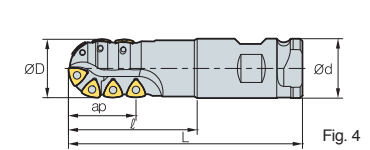
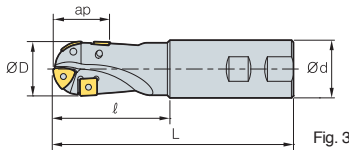
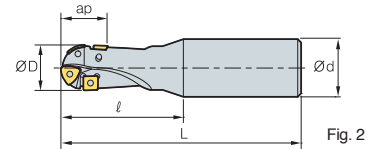
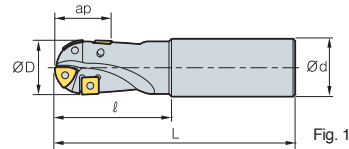
Designation	Coated					page
	NCM325	PC3700	PC5300	PC5400	PC6510	
SPMT 060304	●					E27
ZDMT 080310R-MM		●	●			E33
110312.5R-MM			●			
130416R-MM		●	●			

Parts

Specification	 Screw	 Wrench	 Wrench
Ø20~Ø25	ETNA02506	-	TW07P
Ø32	ETNA0408	TW15S	-

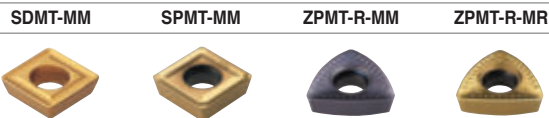
Available inserts E27, E33

BRE



Designation	Dimensions					Available inserts		Parts		kg	Fig.	
	ØD	Ød	l	L	ap	Main	Ext. main	Screw	Wrench			
BRE 40R-S	40	42	85	175	41	ZPMT160520R-MM	SPMT120408-MM SPMT120508-MMN	ETNA0511	TW20-100	1.37	1	
40R-S-40	40	40	85	175	41					1.35		
40R-M	40	42	100	200	41					1.62		
40R-M-40	40	40	100	200	41					1.6		
40R-L	40	42	150	250	41					2.1		
40R-L-40	40	40	150	250	41					2		
40R-SL	40	42	80	160	41					1.21		3
40R-SL-40	40	40	80	160	41	1.2						
50R-S	50	42	100	200	45	ZPMT160525R-MM	SPMT120408-MM SPMT120508-MMN	ETNA0511	TW20-100	2.02	1	
50R-S-40	50	40	100	200	45					1.93		
50R-L	50	42	100	300	45					3.1		
50R-L-40	50	40	100	300	45					2.92		
50R-SL	50	42	100	250	45					2.56		3
50R-SL-40	50	40	100	250	45					2.5		
63R-S	63	42	100	200	52					ZPMT160531.5R-MM		SPMT120408-MM SPMT120508-MMN
63R-S-40	63	40	100	200	52	2.4						
63R-L	63	42	100	300	52	3.5						
63R-L-40	63	40	100	300	52	3.3						
63R-SL	63	42	100	250	52	2.95	3					
63R-SL-40	63	40	100	250	52	2.9						
40XR-SC40	40	40	110	200	54	ZPMT160520R-MM		ETNA0511	TW20-100		1.43	
40XR-LC40	40	40	150	250	54					1.89		
50XR-SC50.8	50	50.8	110	200	57	ZPMT160525R-MM ZPMT160525R-MR		ETNA0511	TW20-100	2.34	4	
50XR-LC50.8	50	50.8	150	250	57					3.06		

Available inserts



Designation	Coated					page
	NCM325	PC3700	PC5300	PC5400	PC6510	
SDMT 090308-MM		●	●			E20
SPMT 120408-MM		●	●			E27
120508-MMN						
ZPMT 160520R-MM		●	●			E33
160525R-MM		●	●			
160525R-MR						
160531.5R-MM			●			

Parts

Specification	Screw	Wrench
Ø40~Ø63	ETNA0511	TW20-100

Available inserts E20, E27, E33



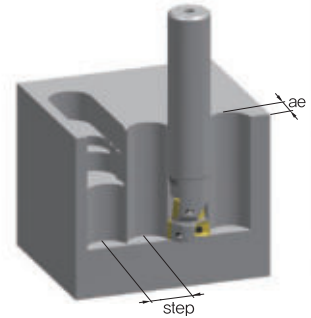
Multifunctional milling tool for mold making

HAVE

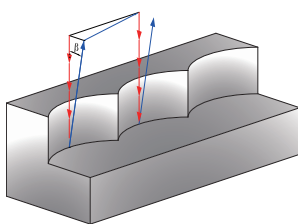
- Tools for Z-axis feed plunge machining to cut faster and more effectively in vertical machining
- Able to utilize the full diameter of the tools, thanks to the position and design of the inserts

Maximum step in vertical machining

ae	Diameter										
	16	17	20	21	25	26	32	33	35	40	50
	max step (mm)										
1	7.7	8	8.7	8.9	9.7	10	11.1	11.3	11.6	12.4	14
2	10.5	10.9	12	12.3	13.5	13.8	15.4	15.7	16.2	17.4	19.5
3	12.4	12.9	14.2	14.6	16.2	16.6	18.6	18.9	19.5	21	23.7
4	13.8	14.4	16	16.4	18.3	18.7	21.1	21.5	22.2	24	27.1
5	14.8	15.4	17.3	17.8	20	20.4	23.2	23.6	24.4	26.4	30
6	15.4	16.2	18.3	18.9	21.3	21.9	24.9	25.4	26.3	28.5	32.4
7	15.8	16.7	19	19.7	22.4	23	26.4	26.9	28	30.3	34.6
8	16	16.9	19.5	20.3	23.3	24	27.7	28.2	29.3	32	36.6
9	15.8	16.9	19.9	20.7	24	24.7	28.7	29.3	30.5	33.4	38.4
10	15.4	16.7	20	20.9	24.4	25.2	29.6	30.3	31.6	34.6	40
11	14.8	16.2	19.9	20.9	24.8	25.6	30.3	31.1	32.4	35.7	41.4
12	13.8	15.4	19.5	20.7	24.9	25.9	30.9	31.7	33.2	36.6	42.7
13	12.4	14.4	19	20.3	24.9	26	31.4	32.2	33.8	37.4	43.8
14	10.5	12.9	18.3	19.7	24.8	25.9	31.7	32.6	34.2	38.1	44.9
15	7.7	10.9	17.3	18.9	24.4	25.6	31.9	32.8	34.6	38.7	45.8
16	-	8	16	17.8	24	25.2	32	32.9	34.8	39.1	46.6
17	-	-	14.2	16.4	23.3	24.7	31.9	32.9	34.9	39.5	47.3
18	-	-	12	14.6	22.4	24	31.7	32.8	34.9	39.7	48
19	-	-	8.7	12.3	21.3	23	31.4	32.6	34.8	39.9	48.5
20	-	-	-	8.9	20	21.9	30.9	32.2	34.6	40	48.9
21	-	-	-	-	18.3	20.4	30.3	31.7	34.2	39.9	49.3
22	-	-	-	-	16.2	18.7	29.6	31.1	33.8	39.7	49.6
23	-	-	-	-	13.5	16.6	28.7	30.3	33.2	39.5	49.8
24	-	-	-	-	9.7	13.8	27.7	29.3	32.4	39.1	49.9
25	-	-	-	-	-	10	26.4	28.2	31.6	38.7	50



Programming in vertical cutting



- Vertical machining route
- Rapid feed
- β Angle between tool and workpiece ($\beta \geq 1^\circ$)

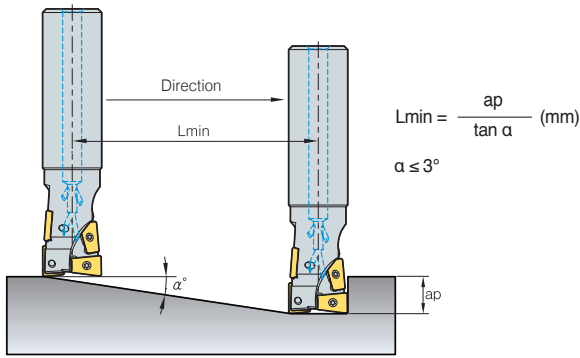
- Reduce 30% of feed till 3 mm machining
- Have the tool be away from the workpiece more than 1° (b) after finishing the machining or when moving the tool to the next step.

Cutting condition

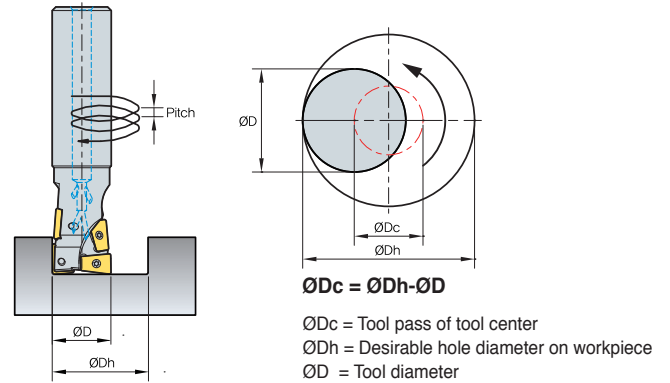
Designation	Hardness	Grades	Cutting condition vc (m/min)	Ø16, 17		Ø20, 21		Ø25, 26		Ø32, 33		Ø35		Ø40		Ø50	
				Feed	Step	Feed	Step	Feed	Step	Feed	Step	Feed	Step	Feed	Step		
P	Mild steel, Low Carbon steel (SS400)	Under 200HB	PC3700	200 (150~250)	0.03 0.20	0.04 0.30	0.05 0.30	0.05 0.30	0.06 0.30	0.06 0.30	0.07 0.30	0.07 0.30	0.07 0.30	0.07 0.30	0.07 0.30	0.07 0.30	0.07 0.30
	Carbon steel, Alloy steel (SM50C, SCM440)	Under 100HrC	PC3700	180 (120~220)	0.03 0.20	0.04 0.30	0.05 0.30	0.05 0.30	0.05 0.30	0.06 0.30	0.06 0.30	0.06 0.30	0.06 0.30	0.06 0.30	0.06 0.30	0.06 0.30	0.06 0.30
M	Stainless steel (STS)	Under 270HB	PC5300	160 (120~200)	0.03 0.15	0.04 0.25	0.05 0.25	0.05 0.25	0.05 0.25	0.06 0.25	0.06 0.25	0.06 0.25	0.06 0.25	0.06 0.25	0.06 0.25	0.06 0.25	0.06 0.25
K	Cast iron (GC, GCD)	350N/mm ²	PC5300	200 (150~250)	0.04 0.40	0.05 0.50	0.06 0.50	0.06 0.50	0.06 0.50	0.07 0.50	0.07 0.50	0.07 0.50	0.07 0.50	0.07 0.50	0.07 0.50	0.07 0.50	0.07 0.50
H	Hardened steel	40~55HrC	PC5300	80 (50~120)	0.03 0.15	0.03 0.25	0.04 0.25	0.04 0.25	0.04 0.25	0.04 0.25	0.04 0.25	0.04 0.25	0.04 0.25	0.04 0.25	0.04 0.25	0.05 0.25	0.05 0.25

* Please note - Step machining is required for aspect ratio under 0.5D or initial drilling

1. Ramping



2. Helical cutting



➤ Cutting condition for ramping and helical operation

Designation	Hardness	Grades	Cutting Speed vc (m/min)	Ø16, 17				Ø20, 21				Ø25, 26				Ø32, 33				Ø35				Ø40				Ø50			
				ØDh (mm)	ap (mm/t)	fz (mm/t)	max pitch (mm)	ØDh (mm)	ap (mm/t)	fz (mm/t)	max pitch (mm)	ØDh (mm)	ap (mm/t)	fz (mm/t)	max pitch (mm)	ØDh (mm)	ap (mm/t)	fz (mm/t)	max pitch (mm)	ØDh (mm)	ap (mm/t)	fz (mm/t)	max pitch (mm)	ØDh (mm)	ap (mm/t)	fz (mm/t)	max pitch (mm)	ØDh (mm)	ap (mm/t)	fz (mm/t)	max pitch (mm)
P Mild steel, Low Carbon steel (SS400)	≤ 200HB	PC3700	200 (150-250)	19 ~30	0.5D ~1D	0.15 ~0.12	0.35 ~1.61	23 ~28	0.5D ~1D	0.18 ~0.12	0.35 ~2.07	29 ~47	0.5D ~1D	0.2 ~0.15	0.46 ~2.53	37 ~60	0.5D ~1D	0.25 ~0.2	0.58 ~3.23	41 ~65	0.5D ~1D	0.28 ~0.2	0.69 ~3.46	47 ~75	0.5D ~1D	0.3 ~0.2	0.81 ~4.03	58 ~95	0.5D ~1D	0.35 ~0.25	0.92 ~5.18
			180 (120-220)	19 ~30	0.5D ~1D	0.15 ~0.1	0.26 ~1.23	23 ~28	0.5D ~1D	0.16 ~0.12	0.26 ~1.58	29 ~47	0.5D ~1D	0.18 ~0.12	0.35 ~1.93	37 ~60	0.5D ~1D	0.2 ~0.15	0.44 ~2.46	41 ~65	0.5D ~1D	0.22 ~0.17	0.53 ~2.63	47 ~75	0.5D ~1D	0.25 ~0.2	0.61 ~3.07	58 ~95	0.5D ~1D	0.28 ~0.25	0.70 ~3.95
M Stainless steel (STS)	≤ 270HB	PC5300	160 (120-200)	19 ~30	0.2D ~0.5D	0.13 ~0.1	0.18 ~0.84	23 ~28	0.2D ~0.5D	0.15 ~0.12	0.18 ~1.09	29 ~47	0.2D ~0.5D	0.18 ~0.12	0.24 ~1.33	37 ~60	0.2D ~0.5D	0.2 ~0.15	0.24 ~1.33	41 ~65	0.2D ~0.5D	0.22 ~0.17	0.36 ~1.81	47 ~75	0.2D ~0.5D	0.25 ~0.2	0.42 ~2.11	58 ~95	0.2D ~0.5D	0.28 ~0.25	0.48 ~2.71
			200 (150-250)	19 ~30	0.7D ~1D	0.17 ~0.12	0.43 ~2.0	23 ~28	0.7D ~1D	0.2 ~0.12	0.42 ~2.57	29 ~47	0.7D ~1D	0.2 ~0.15	0.57 ~3.14	37 ~60	0.7D ~1D	0.25 ~0.2	0.71 ~3.99	41 ~65	0.7D ~1D	0.28 ~0.2	0.86 ~4.28	47 ~75	0.7D ~1D	0.3 ~0.2	1.0 ~4.99	58 ~95	0.7D ~1D	0.35 ~0.25	1.14 ~6.42
K Cast iron (GC, GCD)	≤ 350N/mm ²	PC5300	200 (150-250)	19 ~30	0.7D ~1D	0.17 ~0.12	0.43 ~2.0	23 ~28	0.7D ~1D	0.2 ~0.12	0.42 ~2.57	29 ~47	0.7D ~1D	0.2 ~0.15	0.57 ~3.14	37 ~60	0.7D ~1D	0.25 ~0.2	0.71 ~3.99	41 ~65	0.7D ~1D	0.28 ~0.2	0.86 ~4.28	47 ~75	0.7D ~1D	0.3 ~0.2	1.0 ~4.99	58 ~95	0.7D ~1D	0.35 ~0.25	1.14 ~6.42
			80 (50-120)	19 ~30	0.2D ~0.5D	0.1 ~0.05	0.18 ~0.84	23 ~28	0.2D ~0.5D	0.12 ~0.07	0.18 ~1.09	29 ~47	0.2D ~0.5D	0.13 ~0.1	0.24 ~1.33	37 ~60	0.2D ~0.5D	0.15 ~0.12	0.30 ~1.69	41 ~65	0.2D ~0.5D	0.17 ~0.13	0.36 ~1.81	47 ~75	0.2D ~0.5D	0.18 ~0.15	0.42 ~2.11	58 ~95	0.2D ~0.5D	0.2 ~0.15	0.48 ~2.71
H Hardened steel	40-55HRC	PC5300	80 (50-120)	19 ~30	0.2D ~0.5D	0.1 ~0.05	0.18 ~0.84	23 ~28	0.2D ~0.5D	0.12 ~0.07	0.18 ~1.09	29 ~47	0.2D ~0.5D	0.13 ~0.1	0.24 ~1.33	37 ~60	0.2D ~0.5D	0.15 ~0.12	0.30 ~1.69	41 ~65	0.2D ~0.5D	0.17 ~0.13	0.36 ~1.81	47 ~75	0.2D ~0.5D	0.18 ~0.15	0.42 ~2.11	58 ~95	0.2D ~0.5D	0.2 ~0.15	0.48 ~2.71

➤ Recommended cutting condition in shouldering

Designation	Hardness	Grades	Cutting Speed vc (m/min)	Ø16, 17			Ø20, 21			Ø25, 26			Ø32, 33			Ø35			Ø40			Ø50		
				max ap (mm)	max ae (mm)	max fz (mm/t)	max ap (mm)	max ae (mm)	max fz (mm/t)	max ap (mm)	max ae (mm)	max fz (mm/t)	max ap (mm)	max ae (mm)	max fz (mm/t)	max ap (mm)	max ae (mm)	max fz (mm/t)	max ap (mm)	max ae (mm)	max fz (mm/t)	max ap (mm)	max ae (mm)	max fz (mm/t)
P Mild steel, Low Carbon steel (SS400)	≤ 200HB	PC3700	200 (150-250)	17	8	0.25	22	10	0.3	27	13	0.35	35	16	0.4	40	18	0.45	44	20	0.5	55	25	0.6
			180 (120-220)	17	8	0.2	22	10	0.25	27	13	0.3	35	16	0.35	40	18	0.4	44	20	0.4	55	25	0.5
M Stainless steel (STS)	≤ 270HB	PC5300	160 (120-200)	17	8	0.2	22	10	0.25	27	13	0.3	35	16	0.35	40	18	0.4	44	20	0.4	55	25	0.5
			200 (150-250)	17	8	0.25	22	10	0.3	27	13	0.35	35	16	0.4	40	18	0.45	44	20	0.5	55	25	0.6
K Cast iron (GC, GCD)	≤ 350N/mm ²	PC5300	200 (150-250)	17	8	0.25	22	10	0.3	27	13	0.35	35	16	0.4	40	18	0.45	44	20	0.5	55	25	0.6
			80 (50-120)	17	5	0.15	22	6	0.2	27	7	0.22	35	8	0.25	40	9	0.3	44	10	0.3	55	14	0.35

➤ Recommended cutting condition in grooving

Designation	Hardness	Grades	Cutting Speed vc (m/min)	Ø16, 17		Ø20, 21		Ø25, 26		Ø32, 33		Ø35		Ø40		Ø50	
				max ap (mm)	max fz (mm/t)	max ap (mm)	max fz (mm/t)	max ap (mm)	max fz (mm/t)	max ap (mm)	max fz (mm/t)	max ap (mm)	max fz (mm/t)	max ap (mm)	max fz (mm/t)	max ap (mm)	max fz (mm/t)
P Mild steel, Low Carbon steel (SS400)	≤ 200HB	PC3700	200 (150-250)	17	0.15	22	0.18	27	0.2	35	0.25	40	0.27	44	0.3	55	0.35
			180 (120-220)	17	0.15	22	0.15	27	0.18	35	0.2	40	0.22	44	0.25	55	0.3
M Stainless steel (STS)	≤ 270HB	PC5300	160 (120-200)	17	0.15	22	0.15	27	0.18	35	0.2	40	0.22	44	0.25	55	0.3
			200 (150-250)	17	0.15	22	0.18	27	0.2	35	0.25	40	0.27	44	0.3	55	0.35
K Cast iron (GC, GCD)	≤ 350N/mm ²	PC5300	200 (150-250)	17	0.15	22	0.18	27	0.2	35	0.25	40	0.27	44	0.3	55	0.35
			80 (50-120)	12	0.1	14	0.12	17	0.15	22	0.15	25	0.18	28	0.18	35	0.22



HAVE (Multi-edge)

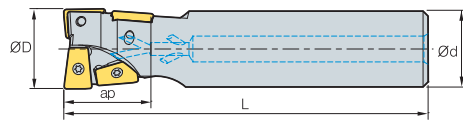


Fig. 1

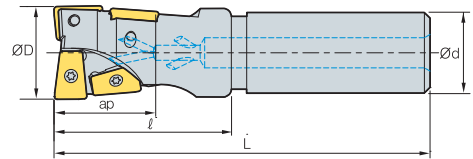


Fig. 2



• AR: 7°~12°
• RR: -12°~4°

(mm)

Designation		ØD	Ød	ℓ	L	ap	Available inserts		Fig.
HAVE 0816HR-S16M	4	16	16	30	120	17.6	XPMT0802ER-MM	0.15	1
	4	16	16	30	200	17.6		0.26	
0817HR-S16M	4	17	16	30	120	17.6		0.18	2
0817HR-L16M	4	17	16	30	200	17.6		0.27	
1020HR-S20M	4	20	20	35	130	22	XPMT1003ER-MM	0.26	1
1020HR-L20M	4	20	20	35	210	22		0.44	
1021HR-S20M	4	21	20	35	130	22		0.26	2
1021HR-L20M	4	21	20	35	210	22		0.45	
1325HR-S25M	4	25	25	45	140	27	XPMT13T3ER-MM	0.41	1
1325HR-L25M	4	25	25	45	220	27		0.71	
1326HR-S25M	4	26	25	45	140	27		0.45	2
1326HR-L25M	4	26	25	45	220	27		0.68	
1632HR-S32M	4	32	32	50	150	35.2	XPMT1604ER-MM	0.72	1
1632HR-L32M	4	32	32	50	250	35.2		1.32	
1633HR-S32M	4	33	32	50	150	35.2		0.76	2
1633HR-L32M	4	33	32	50	250	35.2		1.27	
1835HR-S32M	4	35	32	50	150	40	XPMT1805ER-MM	0.75	1
1835HR-L32M	4	35	32	50	230	40		1.23	
2040HR-S32M	4	40	32	55	160	44	XPMT2006ER-MM	0.74	2
2040HR-L32M	4	40	32	55	240	44		1.35	
2550HR-S42M	4	50	42	70	170	55	XPMT2507ER-MM	1.53	2
2550HR-L42M	4	50	42	70	250	55		2.60	

Available inserts

XPMT-MM



Designation	Cermet		Coated										Uncoated			page			
	CN2500	CN30	NC5330	NCM825	NCM335	NCM535	NCM545	PC2505	PC2510	PC3700	PC6510	PC9530	PC9540	PC5300	PC5400		ST30A	G10	H01
XPMT 0802ER-MM														●					E32
1003ER-MM									●					●					
13T3ER-MM														●					
1604ER-MM														●					
1805ER-MM														●					
2006ER-MM														●					
2507ER-MM														●					

Parts

Specification		
Ø16~Ø17	FTNA0204	TW06S
Ø20~Ø21	FTNA02205	TW09S
Ø25~Ø26	FTKA0307	TW15S
Ø32~Ø33	FTKA0408	TW20S
Ø35		
Ø40	FTGA0511-P	
Ø50	FTNA0615	

Available inserts E32

HAVE (Single-edge)

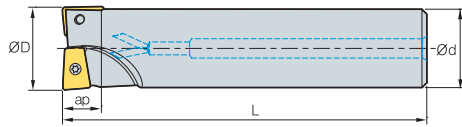


Fig. 1

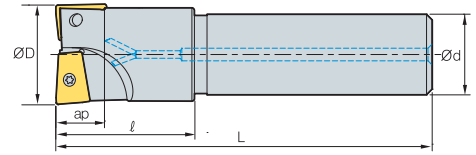


Fig. 2



AA 90°
 • AR: 7°~12°
 • RR: -12°~4°

(mm)

Designation		ØD	Ød	ℓ	L	ap	Available inserts		Fig.
HAVE									
0816HR-S16	2	16	16	30	120	7.5	XPMT0802ER-MM	0.16	1
0816HR-L16	2	16	16	30	200	7.5		0.27	
0817HR-S16	2	17	16	30	120	7.5		0.16	2
0817HR-L16	2	17	16	30	200	7.5	0.27		
1020HR-S20	2	20	20	35	130	9.5	XPMT1003ER-MM	0.28	1
1020HR-L20	2	20	20	35	210	9.5		0.46	
1021HR-S20	2	21	20	35	130	9.5		0.28	2
1021HR-L20	2	21	20	35	210	9.5	0.46		
1325HR-S25	2	25	25	45	140	12	XPMT13T3ER-MM	0.44	1
1325HR-L25	2	25	25	45	220	12		0.76	
1326HR-S25	2	26	25	45	140	12		0.47	2
1326HR-L25	2	26	25	45	220	12	0.76		
1632HR-S32	2	32	32	50	150	15.4	XPMT1604ER-MM	0.77	1
1632HR-L32	2	32	32	50	250	15.4		1.36	
1633HR-S32	2	33	32	50	150	15.4		0.81	2
1633HR-L32	2	33	32	50	250	15.4	1.41		
1835HR-S32	2	35	32	50	150	16.7	XPMT1805ER-MM	0.81	1
1835HR-L32	2	35	32	50	230	16.7		1.28	
2040HR-S32	2	40	32	55	160	19.3	XPMT2006ER-MM	0.95	2
2040HR-L32	2	40	32	55	240	19.3		1.45	
2550HR-S42	2	50	42	70	170	24	XPMT2507ER-MM	1.68	2
2550HR-L42	2	50	42	70	250	24		2.54	

Available inserts

XPMT-MM



Designation	Cermet		Coated										Uncoated			page			
	CN2500	CN30	NC6330	NCM325	NCM335	NCM535	NCM545	PC2505	PC2510	PC3700	PC6510	PC9530	PC9540	PC5300	PC5400		ST30A	G10	H01
XPMT 0802ER-MM														●					E32
1003ER-MM										●				●					
13T3ER-MM														●					
1604ER-MM														●					
1805ER-MM														●					
2006ER-MM														●					
2507ER-MM														●					

Parts

Specification		
Ø16~Ø17	FTNA0204	TW06S
Ø20~Ø21	FTNA02205	TW09S
Ø25~Ø26	FTKA0307	TW15S
Ø32~Ø33	FTKA0408	TW15S
Ø35		
Ø40	FTGA0511-P	TW20S
Ø50	FTNA0615	



Guarantee strong constrain force by 2-side constraint

BT/HSK Tooling System

Code system

• Single, Multi-edge

BT50	HAT	4	063	114	- 4	F
Arbor type	Item Name	Type	Diameter	Length (ap)	No. of flute	Front piece or total length
BT30/40/50 HSK40/50/63/100	AM HAT RM	1000 type 1500 type 2000 type 3000 type 4000 type	063: Ø63	Length: 114 HS: Coolant + Single	No. of flute: 4 No. of tooth: 4	Front Piece (Y/N) Y: F No code: No L: Long type

• Modular

BT50	MAT	M16	092
Arbor type	Item category	M Dimensions	Total length (L)
BT30/40/50 HSK40/50/63/100	MAT	M16	092: 92

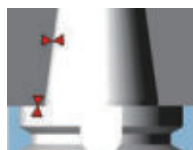
DBT system

Feature of (D)BT arbor

- Guaranteed strong force by 2-side constraint
- Guarantee strengthen cutting at high speed
- Guaranteed superior surface roughness

DBT (Constrain, increased surface roughness)

2-side constraint
(Taper, 1-side)



DBT Workpiece
Ra = 0.3µm

BT

1-side constraint
(Taper)



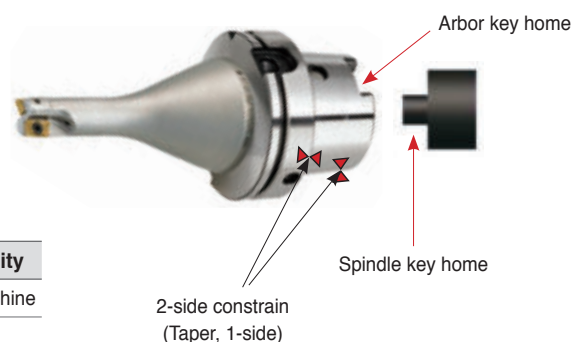
BT Workpiece
Ra = 0.5µm

HSK system

Feature of HSK arbor

- Guaranteed strong constrain force by 2-side constraint
- Guaranteed strengthened cutting at high speeds
- Guaranteed superior surface roughness
- Guaranteed repeatability at axle direction and repeated direction

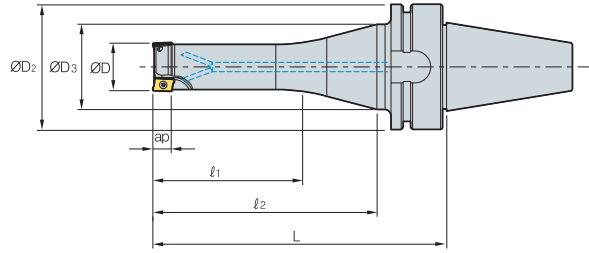
HSK A: HSK T key tolerance comparison



HSK tolerance comparison

Arbor type	Max. tolerance	Min. tolerance	Available facility
HSK-T	0.075	0.035	Multi-tasking machine
HSK-A	0.33	0.08 (General)	MCT

BT30 AM1000HS



AA
90°
• AR: 7.5°~13°
• RR: -28°~7°

(mm)

Designation		ØD	ØD2	ØD3	l1	l2	L	ap	
BT30	AM1010HS-2	2	10	46	41	35	83	112	5.6
	AM1012HS-2	2	12	46	41	35	83	112	5.6
	AM1012HS-3	3	12	46	41	35	83	112	5.6
	AM1016HS-3	3	16	46	41	35	83	112	5.6
	AM1016HS-4	4	16	46	41	35	83	112	5.6
	AM1020HS-4	4	20	46	41	45	98	127	5.6
	AM1020HS-5	5	20	46	41	45	98	127	5.6

Available inserts

APMT-MA APMT-MM



Designation	Cermet		Coated												Uncoated		page		
	CN2500	CN30	NC5330	NCM325	NCM335	NCM535	NCM545	PC2505	PC2510	PC3700	PC6510	PC9530	PC9540	PC5300	PC5400	G10		H01	
APMT 0602PDFR-MA																		●	E06
060208PDFR-MA																			
060202PDSR-MM			●							●					●	●			
0602PDSR-MM			●					●	●	●	●	●		●	●				
060208PDSR-MM			●							●				●	●				
060212R-MM			●											●	●				
060216R-MM														●	●				

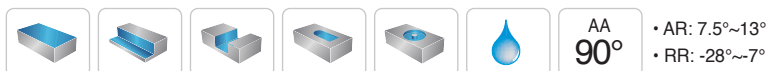
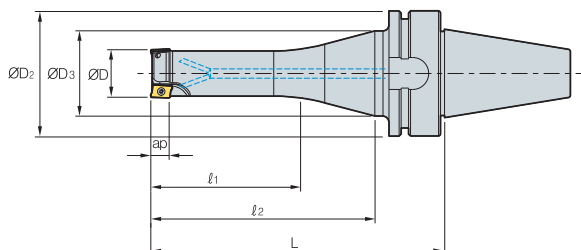
Parts

Specification			
Ø10~Ø20	FTKA01842	-	TW06S-A

Available inserts E06



BT40 AM1500HS



(mm)

Designation		ØD	ØD ₂	ØD ₃	l ₁	l ₂	L	ap	
BT40	AM15016HS-2	2	16	63	50	45	83	117	9
	AM15016HS-2L	2	16	63	50	35	118	152	9
	AM15020HS-2	2	20	63	50	60	98	132	9
	AM15020HS-3	3	20	63	50	60	98	132	9
	AM15020HS-2L	2	20	63	50	50	118	152	9
	AM15025HS-3	3	25	63	50	75	113	147	9
	AM15025HS-4	4	25	63	50	75	113	147	9
	AM15025HS-3L	3	25	63	50	65	133	167	9
	AM15032HS-4	4	32	63	50	80	113	147	9
	AM15032HS-5	5	32	63	50	80	113	147	9
	AM15032HS-4L	4	32	63	50	70	133	167	9
	AM15040HS-5	5	40	63	50	60	98	132	9
	AM15040HS-6	6	40	63	50	60	98	132	9
	AM15040HS-5L	5	40	63	50	50	118	152	9

Available inserts

APMT-MA APMT-ML APMT-MM



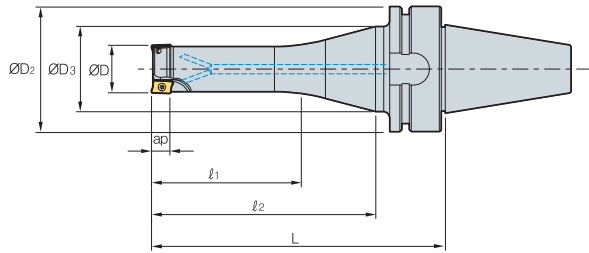
Designation	Cermet		Coated											Uncoated		page		
	CN2500	CN30	NC5330	NCM325	NCM335	NCM535	NCM545	PC2505	PC2510	PC3700	PC6510	PC9530	PC9540	PC5300	PC5400		G10	H01
APMT 0903PDFR-MA																	●	E06
090308PDFR-MA																		
0903PDER-ML														●	●			
090308PDER-ML														●	●			
0903PDSR-MM			●					●	●	●	●			●	●			
090308PDSR-MM			●							●				●	●			
090312R-MM										●				●	●			
090316R-MM			●							●				●	●			
090320R-MM										●				●	●			

Parts

Specification			
Ø16~Ø40	FTKA02565S	TW08S	-

Available inserts E06

BT40 AM2000HS



AA
90°
• AR: 7°~10°
• RR: -20°~7°

(mm)

Designation		ØD	ØD ₂	ØD ₃	l ₁	l ₂	L	ap	
BT40	AM2016HS-2	2	16	63	50	45	83	117	11
	AM2016HS-2L	2	16	63	50	35	118	152	11
	AM2020HS-2	2	20	63	50	60	98	132	11
	AM2020HS-2L	2	20	63	50	50	118	152	11
	AM2025HS-3	3	25	63	50	75	113	147	11
	AM2025HS-3L	3	25	63	50	65	133	167	11
	AM2032HS-4	4	32	63	50	80	113	147	11
	AM2032HS-4L	4	32	63	50	70	133	167	11
	AM2040HS-5	5	40	63	50	60	98	132	11
	AM2040HS-5L	5	40	63	50	50	118	152	11
	AM2050HS-6	6	50	63	50	60	98	132	11
	AM2050HS-6L	6	50	63	50	50	118	152	11

Available inserts



Designation	Cermet		Coated												Uncoated		page	
	CN2500	CN30	NC5330	NCM325	NCM335	NCM535	NCM645	PC2505	PC2510	PC3700	PC6510	PC9530	PC9540	PC5300	PC5400	G10		H01
APMT 11T3PDFR-MA																		
11T308PDFR-MA																		
11T3PDER-ML														●	●			
11T308PDER-ML														●	●			
11T3PDSR-MM			●	●		●		●	●	●	●	●	●	●	●			
11T3PDSR-MF			●						●	●				●	●			
11T308PDSR-MM			●							●		●	●	●	●			
11T312PDSR-MM			●									●		●	●			
11T316R-MM			●							●				●	●			
11T318R-MM																		
11T324R-MM			●							●				●	●			
11T3PDSR-MN2														●				
11T3PDSR-MN3														●				

* Please purchase 2 types of APMT-MN (nick type) inserts with different chip breakers. * Please use the cutters with even teeth.

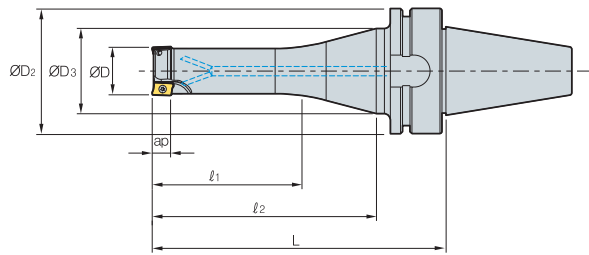
Parts

Specification		
Ø16-Ø50	FTKA02565S	TW08S

Available inserts E06



BT50 AM3000HS



Designation		ØD	ØD2	ØD3	l1	l2	L	ap	
BT50	AM3025HS-2	2	25	100	80	65	113	158	16
	AM3025HS-2L	2	25	100	80	55	123	168	16
	AM3032HS-3	3	32	100	80	70	113	158	16
	AM3032HS-3L	3	32	100	80	60	123	168	16
	AM3040HS-4	4	40	100	80	50	98	143	16
	AM3040HS-4L	4	40	100	80	40	108	153	16
	AM3050HS-5	5	50	100	80	50	98	143	16
	AM3050HS-5L	5	50	100	80	40	108	153	16

Available inserts



Designation	Cermet		Coated											Uncoated		page	
	CN2500	CN30	NC5330	NCM325	NCM335	NCM535	NCM545	PC2505	PC2510	PC3700	PC6510	PC9530	PC9540	PC5300	PC5400		G10
APMT 1604PDFR-MA																	●
160404PDFR-MA																	
1604PDER-ML														●	●		
160404PDER-ML														●	●		
1604PDSR-MM			●	●		●		●	●	●	●	●	●	●	●		
1604PDSR-MF			●						●	●				●	●		
160410PDSR-MM									●					●	●		
160416PDSR-MM			●						●					●	●		
160424R-MM			●						●					●	●		
160430R-MM									●					●	●		
160432R-MM			●						●					●	●		
1604PDSR-MN3														●			
1604PDSR-MN4														●			

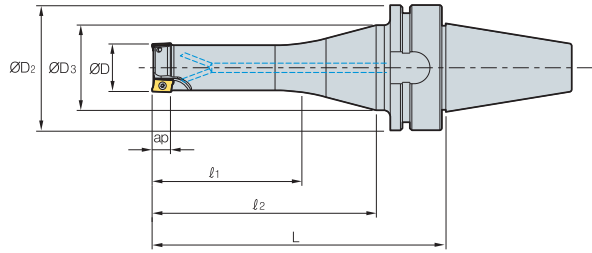
※ Please purchase 2 types of APMT-MN (nick type) inserts with different chip breakers. ※ Please use the cutters with even teeth.

Parts

Specification		
Ø25 Ø32-Ø50	FTKA0408 FTKA0410	TW15S

Available inserts E06

BT50 AM4000HS



AA
90°
• AR: 7°~10°
• RR: -20°~7°

(mm)

Designation	Teeth	ØD	ØD2	ØD3	ℓ1	ℓ2	L	ap
BT50 AM4020HS-1	1	20	100	80	50	98	143	17
AM4025HS-2	2	25	100	80	65	113	158	17
AM4032HS-3	3	32	100	80	70	113	158	17
AM4032HS-3L	3	32	100	80	60	123	168	17
AM4040HS-4	4	40	100	80	50	98	143	17
AM4040HS-4L	4	40	100	80	40	108	153	17
AM4050HS-5	5	50	100	80	50	98	143	17
AM4050HS-5L	5	50	100	80	40	108	153	17

Available inserts



Designation	Cermet		Coated										Uncoated		page		
	CN2500	CN30	NC5330	NCM325	NCM335	NCM535	NCM545	PC2505	PC2510	PC3700	PC6510	PC9530	PC9540	PC5300		PC5400	G10
APMT 1806PDFR-MA																	●
180604PDFR-MA																	●
180612PDFR-MA																	●
180616PDFR-MA																	●
180620PDFR-MA																	●
180624PDFR-MA																	●
180630R-MA																	●
1806PDER-ML														●	●		
180604PDER-ML														●	●		
180612PDER-ML														●	●		
180616PDER-ML														●	●		
180620PDER-ML														●	●		
180624PDER-ML														●	●		
180630R-ML														●	●		
1806PDSR-MM				●				●	●	●	●	●		●	●		
1806PDSR-MF				●						●				●	●		
180612PDSR-MM				●						●				●	●		
180616PDSR-MM				●										●	●		
180620PDSR-MM				●										●	●		
180624PDSR-MM				●										●	●		
180630R-MM				●										●	●		
180632R-MM				●										●	●		
1806PDSR-MN3														●	●		
1806PDSR-MN4														●	●		

E06

* Please purchase 2 types of APMT-MN (nick type) inserts with different chip breakers. * Please use the cutters with even teeth.

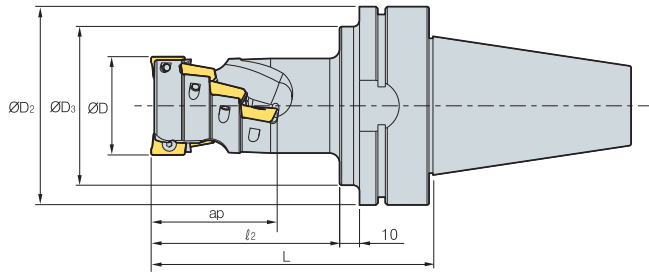
Parts

Specification	Screw	Wrench
Ø20~Ø25	FTKA0408	TW15S
Ø32~Ø50	FTKA0410	TW15S

Available inserts E06



BT30/40 AM1000



AA
90°

• AR: -12.5°~13°
• RR: -17°~-6°

(mm)

Designation		ØD	ØD2	ØD3	l2	L	No. of flute	ap	
BT30	AM1016015-2	6	16	46	41	30	62	2	15.5
	AM1020020-3	12	20	46	41	32	64	3	20.5
	AM1025025-4	20	25	46	41	39	71	4	25.5
BT40	AM1016015-2	6	16	63	50	30	67	2	15.5
	AM1020020-3	12	20	63	50	32	69	3	20.5
	AM1025025-4	20	25	63	50	39	76	4	25.5

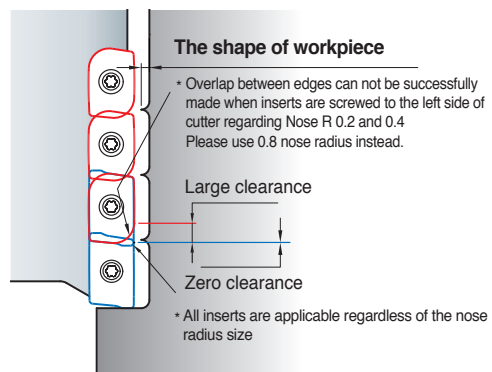
Available inserts

APMT-MA APMT-MM



Designation	Cermet		Coated										Uncoated		page			
	CN2500	CN30	NC5330	NCM325	NCM335	NCM535	NCM545	PC2505	PC2510	PC3700	PC6510	PC9530	PC9540	PC5300		PC5400	G10	H01
APMT 0602PDFR-MA																	●	E06
060208PDFR-MA																		
060202PDSR-MM			●											●	●			
0602PDSR-MM			●					●	●	●	●	●		●	●			
060208PDSR-MM			●											●	●			
060212R-MM			●											●	●			
060216R-MM														●	●			

Caution when clamping the inserts

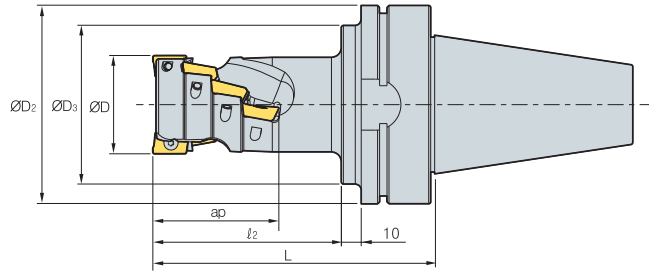


Parts

Specification			
Ø16~Ø25	FTKA01842	-	TW06S-A

Available inserts E06

BT30/40 AM1500



(mm)

Designation		ØD	ØD ₂	ØD ₃	l ₂	L	No. of flute	ap
BT30	AM15020026-1	3	20	46	41	42	74	26.5
	AM15025035-2	8	25	46	41	50	62	35
	AM15032044-2	10	32	46	41	60	92	44
BT40	AM15020026-1	3	20	63	50	42	79	26.5
	AM15025035-2	8	25	63	50	50	87	35
	AM15032044-2	10	32	63	50	60	97	44

Available inserts

APMT-MA APMT-ML APMT-MM

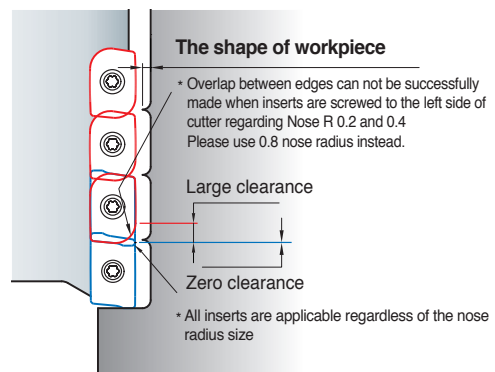


Designation	Cermet		Coated											Uncoated		page		
	CN2500	CN30	NC5330	NCM325	NCM335	NCM535	NCM645	PC2505	PC2510	PC3700	PC6510	PC9530	PC9540	PC5300	PC5400		G10	H01
APMT 0903PDFR-MA																		●
090308PDFR-MA																		
0903PDER-ML																		● ●
090308PDER-ML																		● ●
0903PDSR-MM			●					●	●	●	●							● ●
090308PDSR-MM			●							●								● ●
090312R-MM										●								● ●
090316R-MM			●							●								● ●
090320R-MM										●								● ●

Parts

Specification			
Ø20~Ø32	FTKA02565S	TW08S	-

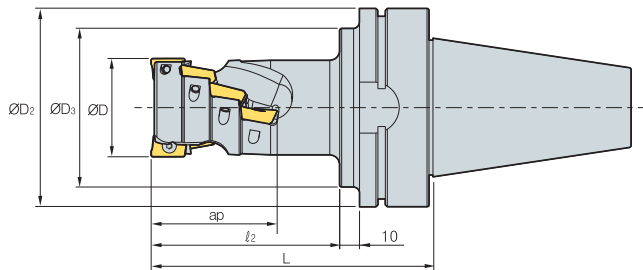
Caution when clamping the inserts



Available inserts E06



BT30/40 AM2000



Designation			ØD	ØD ₂	ØD ₃	l ₂	L	No. of flute	ap
BT30	AM2020029-1	3	20	46	41	45	77	1	29.4
	AM2025038-2	8	25	46	45	55	87	2	38.9
	AM2032048-2	10	32	46	45	65	97	2	48.5
	AM2040058-2	14	40	46	45	75	107	2	58
	AM2050039-4	16	50	46	45	58	90	4	39
	AM2063039-4	16	63	46	45	58	90	4	39
	AM2080039-5	20	80	46	45	63	95	5	39
	AM2100039-6	24	100	46	45	63	95	6	39
BT40	AM2020029-1	3	20	63	50	45	82	1	29.4
	AM2025038-2	8	25	63	50	55	92	2	38.9
	AM2032048-2	10	32	63	50	65	102	2	48.5
	AM2040058-2	14	40	63	50	75	112	2	58
	AM2050039-4	16	50	63	50	58	95	4	39
	AM2063039-4	16	63	63	50	58	95	4	39
	AM2080039-5	20	80	63	50	63	100	5	39
	AM2100039-6	24	100	63	50	63	100	6	39

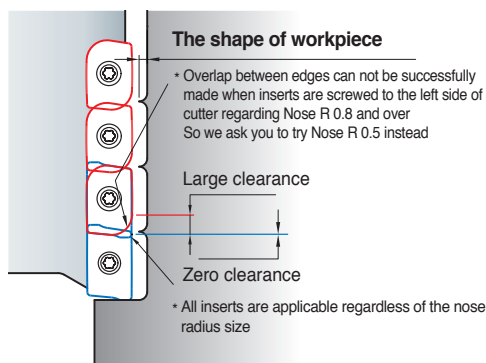
Available inserts



Designation	Cermet		Coated											Uncoated		page		
	CN2500	CN30	NC5330	NCM325	NCM335	NCM535	NCM545	PC2505	PC2510	PC3700	PC6510	PC9530	PC9540	PC5300	PC5400		G10	H01
APMT 11T3PDFR-MA																	●	E06
11T308PDFR-MA																		
11T3PDER-ML														●	●			
11T308PDER-ML														●	●			
11T3PDSR-MM			●	●		●	●	●	●	●	●	●		●	●			
11T3PDSR-MF			●						●					●	●			
11T308PDSR-MM			●						●				●	●				
11T312PDSR-MM			●						●				●	●				
11T316R-MM			●						●					●	●			
11T318R-MM														●	●			
11T324R-MM			●						●					●	●			
11T3PDSR-MN3														●				
11T3PDSR-MN4														●				

※ Please purchase 2 types of APMT-MN (nick type) inserts with different chip breakers.
 ※ Please use the cutters with even teeth.

Caution when clamping the inserts

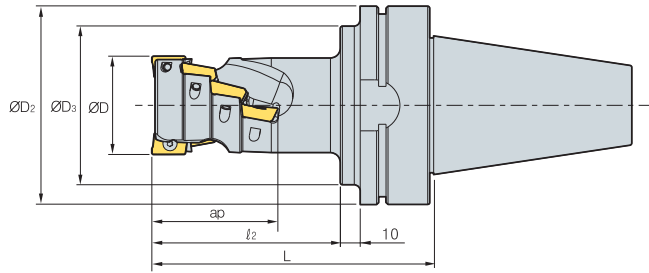


Parts

Specification		
Ø20-Ø100	FTKA02565S	TW08S

Available inserts E06

BT50 AM3000



(mm)

Designation	ØD	ØD2	ØD3	l2	L	No. of flute	ap		
BT50	AM3050043-2	6	50	100	80	72	120	2	43
	AM3063057-4	16	63	100	80	86	134	4	57
	AM3080071-4	20	80	100	80	100	148	4	71
	AM3100071-6	30	100	100	80	100	148	6	71

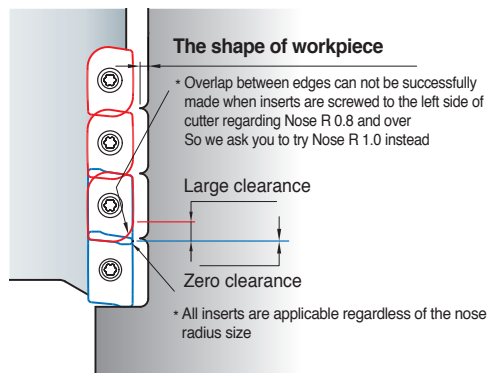
Available inserts



Designation	Cermet		Coated										Uncoated		page			
	CN2500	CN30	NC5330	NCM325	NCM335	NCM535	NCM545	PC2505	PC2510	PC3700	PC6510	PC9530	PC9540	PC5300		PC5400	G10	H01
APMT	1604PDFR-MA																	●
	160404PDFR-MA																	
	1604PDER-ML													●	●			
	160404PDER-ML													●	●			
	1604PDSR-MM		●	●		●		●	●	●	●	●	●	●	●			
	1604PDSR-MF		●											●	●			
	160410PDSR-MM													●	●			
	160416PDSR-MM			●										●	●			
	160424R-MM			●										●	●			
	160430R-MM													●	●			
	160432R-MM			●										●	●			
	1604PDSR-MN3													●				
	1604PDSR-MN4													●				

※ Please purchase 2 types of APMT-MN (nick type) inserts with different chip breakers.
 ※ Please use the cutters with even teeth.

Caution when clamping the inserts



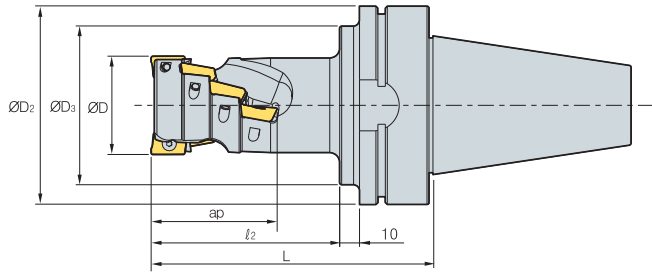
Parts

Specification	Screw	Wrench
Ø50~Ø100	FTKA0410	TW15S

Available inserts E06



BT50 AM4000



(mm)

Designation	ØD	ØD ₂	ØD ₃	l ₂	L	No. of flute	ap
BT50							
AM4040046-2	6	40	100	80	75	2	46
AM4050061-2	8	50	100	80	95	2	61
AM4063061-4	16	63	100	80	90	4	61
AM4080076-4	20	80	100	90	105	4	76
AM4100076-6	30	100	100	80	105	6	76

Available inserts



Designation	Cermet		Coated											Uncoated		page		
	CN2500	CN30	NC5330	NCM325	NCM335	NCM535	NCM545	PC2505	PC2510	PC3700	PC6510	PC9530	PC9540	PC5300	PC5400		G10	H01
APMT																		
1806PDFR-MA																		●
180604PDFR-MA																		●
180612PDFR-MA																		●
180616PDFR-MA																		●
180620PDFR-MA																		●
180624PDFR-MA																		●
180630R-MA																		●
1806PDER-ML														●	●			
180604PDER-ML														●	●			
180612PDER-ML														●	●			
180616PDER-ML														●	●			
180620PDER-ML														●	●			
180624PDER-ML														●	●			
180630R-ML														●	●			
1806PDSR-MM			●					●	●	●	●	●	●	●	●			
1806PDSR-MF			●							●				●	●			
180612PDSR-MM			●						●					●	●			
180616PDSR-MM			●											●	●			
180620PDSR-MM			●											●	●			
180624PDSR-MM			●											●	●			
180630R-MM			●											●	●			
180632R-MM			●											●	●			
1806PDSR-MN3														●				
1806PDSR-MN4														●				

E06

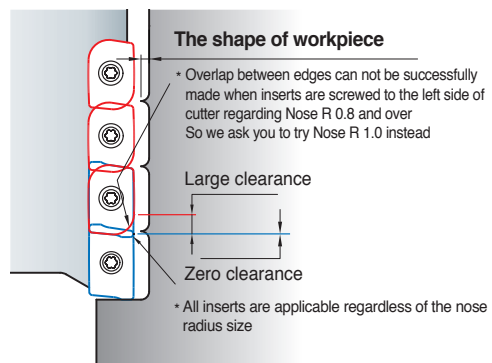
※ Please purchase 2 types of APMT-MN (nick type) inserts with different chip breakers.
 ※ Please use the cutters with even teeth.

Parts

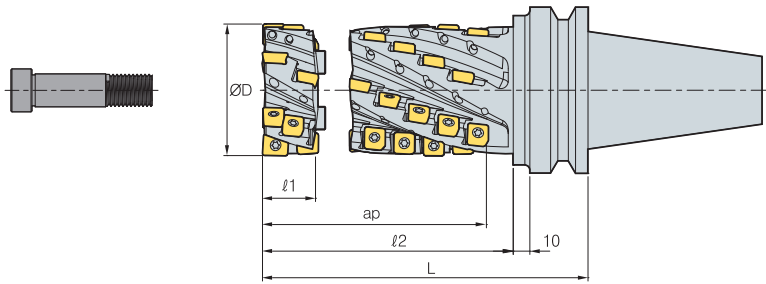
Specification	Screw	Wrench
Ø40~Ø100	FTKA0410	TW15S

Available inserts E06

Caution when clamping the inserts



BT50 HAT4000



(mm)

Designation	SPMT		ØD	l ₁	l ₂	L	No. of flute	ap	Application	
	SPMT	ZPMT								
BT50- (Set)	HAT4050094-2F	10	1	50	32	119	160	2	94	HAT4050032-2F
	HAT4050104-2F	11	1	50	32	129	170	2	104	
	HAT4050114-2F	12	1	50	32	139	180	2	114	
	HAT4063094-4F	20	2	63	32	119	160	4	94	HAT4063032-4F
	HAT4063104-4F	22	2	63	32	129	170	4	104	
	HAT4063114-4F	24	2	63	32	139	180	4	114	
	HAT4080094-4F	20	2	80	33	119	160	4	94	HAT4080033-4F
	HAT4080104-4F	22	2	80	33	129	170	4	104	
HAT4080114-4F	24	2	80	33	139	180	4	114		
HAT4080114-4F	24	2	80	33	139	180	4	114		
(Front Piece)	HAT4050032-2F	3	1	50	32	-	-	2	-	-
	HAT4063032-4F	6	2	63	32	-	-	4	-	
	HAT4080033-4F	6	2	80	33	-	-	4	-	

Available inserts

SPMT-MMN ZPMT-MMN



Designation	Cermet		Coated										Uncoated		page			
	CN2500	CN30	NC5330	NCM325	NCM335	NCM535	NCM545	PC2505	PC2510	PC3700	PC6510	PC9530	PC9540	PC5300		PC5400	G10	H01
SPMT 120508-MMN																		E27
ZPMT 1505PPSR-MMN																		E33

Set specification

Set Designation	Designation	Front Piece	Clamping Bolt
HAT4050094-2F HAT4050104-2F HAT4050114-2F	HAT4050062-2F HAT4050072-2F HAT4050082-2F	HAT4050032-2F	HSB1255
HAT4063094-4F HAT4063104-4F HAT4063114-4F	HAT4063062-4F HAT4063072-4F HAT4063082-4F	HAT4063032-4F	HSB1670
HAT4080094-4F HAT4080104-4F HAT4080114-4F	HAT4080061-4F HAT4080071-4F HAT4080081-4F	HAT4080033-4F	HSB1682

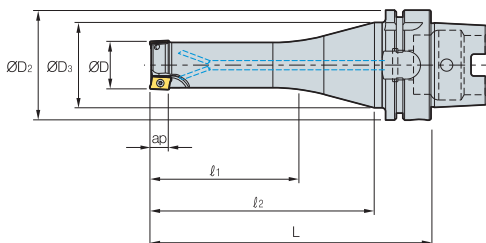
Parts

Specification	Screw	Wrench
Ø50~Ø80	ETNA0511	TW20

Available inserts E27, E33



HSK63A AM1000HS



AA
90°
• AR: 7.5°~13°
• RR: -28°~7°

(mm)

Designation		ØD	ØD2	ØD3	l1	l2	L	ap	
HSK63A	AM1010HS-2	2	10	63	53	35	83	116	5.6
	AM1012HS-2	2	12	63	53	35	83	116	5.6
	AM1012HS-3	3	12	63	53	35	83	116	5.6
	AM1016HS-3	3	16	63	53	35	83	116	5.6
	AM1016HS-4	4	16	63	53	35	83	116	5.6
	AM1020HS-4	4	20	63	53	45	98	131	5.6
	AM1020HS-5	5	20	63	53	45	98	131	5.6

Available inserts

APMT-MA APMT-MM



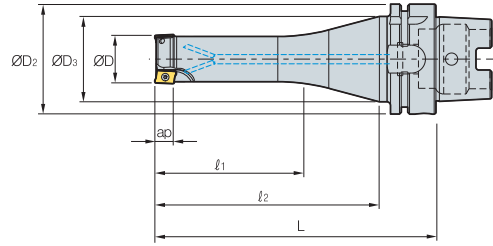
Designation	Cermet		Coated										Uncoated		page			
	CN2500	CN30	NC5330	NCM325	NCM335	NCM535	NCM545	PC2505	PC2510	PC3700	PC6510	PC9530	PC9540	PC5300		PC5400	G10	H01
APMT	0602PDFR-MA																	●
	060208PDFR-MA																	
	060202PDSR-MM			●						●				●	●			
	0602PDSR-MM			●				●	●	●	●	●		●	●			
	060208PDSR-MM			●						●				●	●			
	060212R-MM			●										●	●			
	060216R-MM													●	●			

Parts

Specification			
Ø10~Ø20	FTKA01842	-	TW06S-A

Available inserts E06

HSK63A AM1500HS



AA
90°
• AR: 7.5°~13°
• RR: -28°~7°

(mm)

Designation		ØD	ØD2	ØD3	l1	l2	L	ap	
HSK63A	AM15016HS-2	2	16	63	53	45	83	116	9
	AM15016HS-2L	2	16	63	53	35	118	151	9
	AM15020HS-2	2	20	63	53	60	98	131	9
	AM15020HS-3	3	20	63	53	60	98	131	9
	AM15020HS-2L	2	20	63	53	50	118	151	9
	AM15025HS-3	3	25	63	53	75	113	146	9
	AM15025HS-4	4	25	63	53	75	113	146	9
	AM15025HS-3L	3	25	63	53	65	133	166	9
	AM15032HS-4	4	32	63	53	80	113	146	9
	AM15032HS-5	5	32	63	53	80	113	146	9
	AM15032HS-4L	4	32	63	53	70	133	166	9
	AM15040HS-5	5	40	63	53	60	98	131	9
	AM15040HS-6	6	40	63	53	60	98	131	9
	AM15040HS-5L	5	40	63	53	50	118	151	9

Available inserts

APMT-MA APMT-ML APMT-MM



Designation	Cermet		Coated										Uncoated		page			
	CN2500	CN30	NC5330	NCM325	NCM335	NCM535	NCM545	PC2505	PC2510	PC3700	PC6510	PC9530	PC9540	PC5300		PC5400	G10	H01
APMT 0903PDFR-MA																		
090308PDFR-MA																		
0903PDER-ML														●	●			
090308PDER-ML														●	●			
0903PDSR-MM			●					●	●	●	●			●	●			
090308PDSR-MM			●							●				●	●			
090312R-MM										●				●	●			
090316R-MM			●							●				●	●			
090320R-MM										●				●	●			

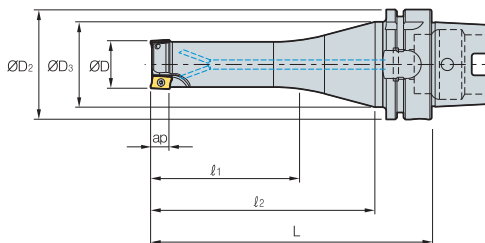
Parts

Specification			
Ø16~Ø40	FTKA02565S	TW08S	-

Available inserts E06



HSK63A AM2000HS



AA
90°
• AR: 7°~10°
• RR: -20°~7°

(mm)

Designation		ØD	ØD ₂	ØD ₃	l ₁	l ₂	L	ap	
HSK63A	AM2016HS-2	2	16	63	53	45	83	116	11
	AM2016HS-2L	2	16	63	53	35	118	151	11
	AM2020HS-2	2	20	63	53	60	98	131	11
	AM2020HS-2L	2	20	63	53	50	118	151	11
	AM2025HS-3	3	25	63	53	75	113	146	11
	AM2025HS-3L	3	25	63	53	65	133	166	11
	AM2032HS-4	4	32	63	53	80	113	146	11
	AM2032HS-4L	4	32	63	53	70	133	166	11
	AM2040HS-5	5	40	63	53	60	98	131	11
	AM2040HS-5L	5	40	63	53	50	118	151	11
	AM2050HS-6	6	50	63	53	60	98	131	11
	AM2050HS-6L	6	50	63	53	50	118	151	11

Available inserts



Designation	Cermet		Coated											Uncoated		page		
	CN2500	CN30	NC5330	NCM325	NCM335	NCM535	NCM545	PC2505	PC2510	PC3700	PC6510	PC9530	PC9540	PC5300	PC5400		G10	H01
APMT 11T3PDFR-MA																		●
11T308PDFR-MA																		
11T3PDER-ML														●	●			
11T308PDER-ML														●	●			
11T3PDSR-MM			●	●		●		●	●	●	●	●		●	●			
11T3PDSR-MF			●						●	●				●	●			
11T308PDSR-MM			●						●	●			●	●	●			
11T312PDSR-MM			●						●				●	●	●			
11T316R-MM			●						●					●	●			
11T318R-MM																		
11T324R-MM			●						●					●	●			
11T3PDSR-MN2														●				
11T3PDSR-MN3														●				

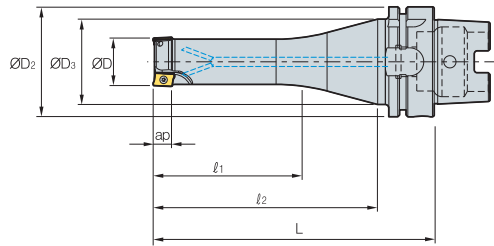
※ Please purchase 2 types of APMT-MN (nick type) inserts with different chip breakers. ※ Please use the cutters with even teeth.

Parts

Specification	Screw	Wrench
Ø16~Ø50	FTKA02565S	TW08S

Available inserts E06

HSK63A AM3000HS



AA
90°
• AR: 7°~10°
• RR: -20°~7°

(mm)

Designation		ØD	ØD2	ØD3	l1	l2	L	ap	
HSK63A	AM3025HS-2	2	25	63	53	65	113	146	16
	AM3025HS-2L	2	25	63	53	55	123	156	16
	AM3032HS-3	3	32	63	53	70	113	146	16
	AM3032HS-3L	3	32	63	53	60	123	156	16
	AM3040HS-4	4	40	63	53	50	98	131	16
	AM3040HS-4L	4	40	63	53	40	108	141	16
	AM3050HS-5	5	50	63	53	50	98	131	16
	AM3050HS-5L	5	50	63	53	40	108	141	16

Available inserts



Designation	Cermet		Coated												Uncoated		page	
	CN2500	CN30	NC5330	NCM325	NCM335	NCM635	NCM645	PC2505	PC2510	PC3700	PC6510	PC9530	PC9540	PC5300	PC5400	G10		H01
APMT																		
1604PDFR-MA																		●
160404PDFR-MA																		
1604PDER-ML														●	●			
160404PDER-ML														●	●			
1604PDSR-MM			●	●		●		●	●	●	●	●	●	●	●			
1604PDSR-MF			●							●	●			●	●			
160410PDSR-MM														●	●			
160416PDSR-MM			●							●				●	●			
160424R-MM			●							●				●	●			
160430R-MM										●				●	●			
160432R-MM			●							●				●	●			
1604PDSR-MN3														●				
1604PDSR-MN4														●				

* Please purchase 2 types of APMT-MN (nick type) inserts with different chip breakers. * Please use the cutters with even teeth.

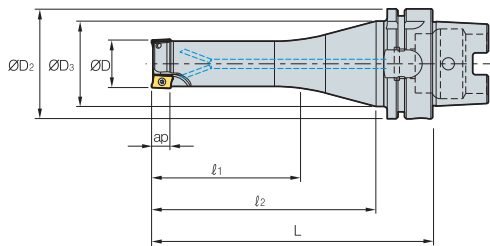
Parts

Specification		
Ø25 Ø32~Ø50	FTKA0408 FTKA0410	TW15S

Available inserts E06



HSK63A AM4000HS



AA
90°
• AR: 7°~10°
• RR: -20°~-7°

(mm)

Designation		ØD	ØD ₂	ØD ₃	l ₁	l ₂	L	ap	
HSK63A	AM4020HS-1	1	20	63	53	50	98	131	17
	AM4025HS-2	2	25	63	53	65	113	146	17
	AM4032HS-3	3	32	63	53	70	113	146	17
	AM4032HS-3L	3	32	63	53	60	123	156	17
	AM4040HS-4	4	40	63	53	50	98	131	17
	AM4040HS-4L	4	40	63	53	40	108	141	17
	AM4050HS-5	5	50	63	53	50	98	131	17
	AM4050HS-5L	5	50	63	53	40	108	141	17

Available inserts



Designation	Cermet		Coated											Uncoated		page		
	CN2500	CN30	NC5330	NCM325	NCM335	NCM535	NCM545	PC2505	PC2510	PC3700	PC6510	PC9530	PC9540	PC5300	PC5400		G10	H01
APMT																		
1806PDFR-MA																		●
180604PDFR-MA																		●
180612PDFR-MA																		●
180616PDFR-MA																		●
180620PDFR-MA																		●
180624PDFR-MA																		●
180630R-MA																		●
1806PDER-ML														●	●			
180604PDER-ML														●	●			
180612PDER-ML														●	●			
180616PDER-ML														●	●			
180620PDER-ML														●	●			
180624PDER-ML														●	●			
180630R-ML														●	●			
1806PDSR-MM					●			●	●	●	●	●	●	●	●			
1806PDSR-MF					●						●			●	●			
180612PDSR-MM					●				●					●	●			
180616PDSR-MM					●									●	●			
180620PDSR-MM					●									●	●			
180624PDSR-MM					●									●	●			
180630R-MM					●									●	●			
180632R-MM					●									●	●			
1806PDSR-MN3														●	●			
1806PDSR-MN4														●	●			

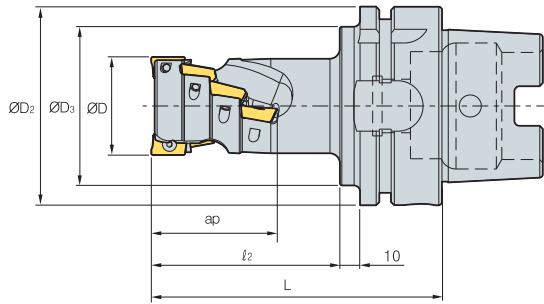
※ Please purchase 2 types of APMT-MN (nick type) inserts with different chip breakers. ※ Please use the cutters with even teeth.

Parts

Specification	Screw	Wrench
Ø20~Ø25	FTKA0408	
Ø32~Ø50	FTKA0410	TW15S

Available inserts E06

HSK63A AM1000



AA
90°

• AR: -12.5°~13°
• RR: -17°~6°

(mm)

Designation		ØD	ØD2	ØD3	l2	L	No. of flute	ap
HSK63A AM1016015-2	6	16	63	53	30	66	2	15.5
AM1020020-3	12	20	63	53	32	68	3	20.5
AM1025025-4	20	25	63	53	39	75	4	25.5

Available inserts

APMT-MA

APMT-MM

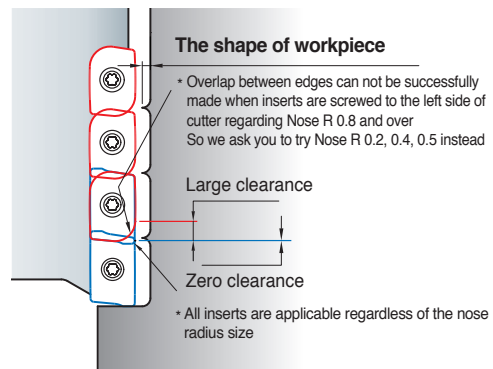


Designation	Cermet		Coated											Uncoated		page		
	CN2500	CN30	NC5330	NCM325	NCM335	NCM535	NCM545	PC2505	PC2510	PC3700	PC6510	PC9530	PC9540	PC5300	PC5400		G10	H01
APMT 0602PDFR-MA																		●
060208PDFR-MA																		
060202PDSR-MM			●							●				●	●			
0602PDSR-MM			●					●	●	●	●	●		●	●			
060208PDSR-MM			●							●				●	●			
060212R-MM			●											●	●			
060216R-MM														●	●			

Parts

Specification			
Ø16~Ø25	FTKA01842	-	TW06S-A

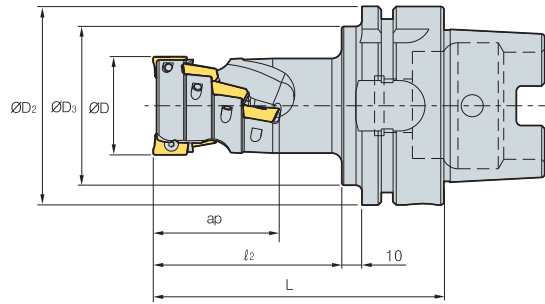
Caution when clamping the inserts



Available inserts E06



HSK63A AM1500



(mm)

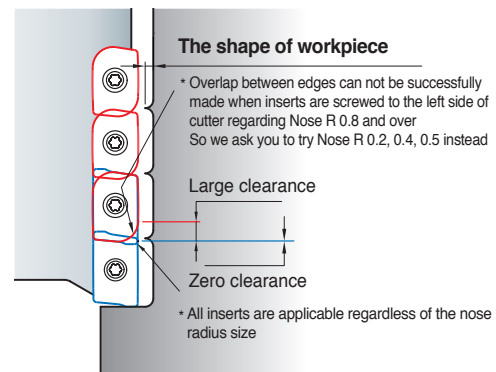
Designation		ØD	ØD ₂	ØD ₃	l ₂	L	No. of flute	ap
HSK63A AM15020026-1	3	20	63	53	42	78	1	26.5
AM15025035-2	8	25	63	53	50	86	2	35
AM15032044-2	10	32	63	53	60	96	2	44

Available inserts



Designation	Cermet		Coated												Uncoated		page	
	CN2500	CN30	NC5330	NCM325	NCM335	NCM535	NCM545	PC2505	PC2510	PC3700	PC6510	PC9530	PC9540	PC5300	PC5400	G10		H01
APMT 0903PDFR-MA																		●
090308PDFR-MA																		
0903PDER-ML																		● ●
090308PDER-ML																		● ●
0903PDSR-MM			●					● ●	● ●									● ●
090308PDSR-MM			●							● ●								● ●
090312R-MM										● ●								● ●
090316R-MM			●							● ●								● ●
090320R-MM										● ●								● ●

Caution when clamping the inserts

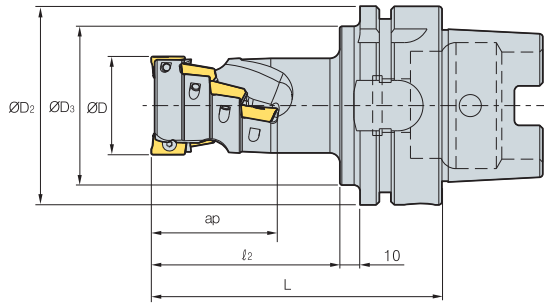


Parts

Specification			
Ø20~Ø32	FTKA02565S	TW08S	-

Available inserts E06

HSK63A AM2000



AA
90°

• AR: -12.5°~13°
• RR: -17°~6°

(mm)

Designation	Flutes	ØD	ØD2	ØD3	l2	L	No. of flute	ap
HSK63A AM2020029-1	3	20	63	53	45	81	1	29.4
AM2025038-2	8	25	63	53	55	91	2	38.9
AM2032048-2	10	32	63	53	65	101	2	48.5
AM2040058-2	14	40	63	53	75	111	2	58
AM2050039-4	16	50	63	53	58	94	4	39
AM2063039-4	16	63	63	53	58	94	4	39
AM2080039-5	20	80	63	53	63	99	5	39
AM2100039-6	24	100	63	53	63	99	6	39

Available inserts

APMT-MA

APMT-ML

APMT-MM

APMT-MF

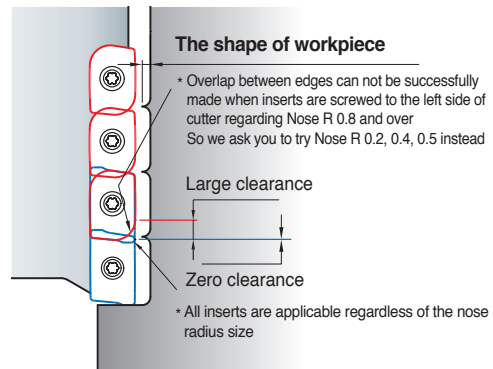
APMT-MN



Designation	Cermet		Coated											Uncoated		page		
	CN2500	CN30	NC5330	NCM325	NCM335	NCM535	NCM545	PC2505	PC2510	PC3700	PC6510	PC9530	PC9540	PC5300	PC5400		G10	H01
APMT 11T3PDFR-MA																	●	E06
11T308PDFR-MA																		
11T3PDER-ML														●	●			
11T308PDER-ML														●	●			
11T3PDSR-MM			●			●		●	●	●	●	●		●	●			
11T3PDSR-MF			●						●	●				●	●			
11T308PDSR-MM			●										●	●	●			
11T312PDSR-MM			●									●		●	●			
11T316R-MM			●											●	●			
11T318R-MM			●											●	●			
11T324R-MM			●							●				●	●			
11T3PDSR-MN3														●	●			
11T3PDSR-MN4														●	●			

※ Please purchase 2 types of APMT-MN (nick type) inserts with different chip breakers.
 ※ Please use the cutters with even teeth.

Caution when clamping the inserts



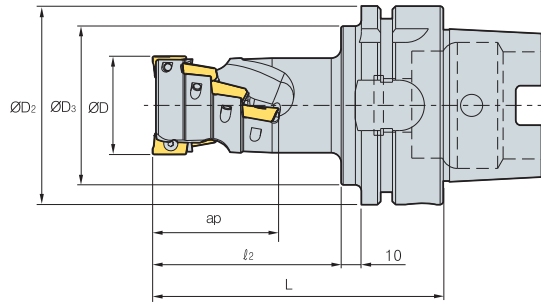
Parts

Specification	Screw	Wrench
Ø20~Ø100	FTKA02565S	TW08S

Available inserts E06



HSK100A AM3000



AA
90°
• AR: -13°~15°
• RR: -11°~4°

(mm)

Designation	⊙	ØD	ØD ₂	ØD ₃	l ₂	ØL	No. of flute	ap
HSK100A AM3050043-2	6	50	100	88	72	111	2	43
AM3063057-4	16	63	100	88	86	125	4	57
AM3080071-4	20	80	100	88	100	139	4	71
AM3100071-6	30	100	100	88	100	139	6	71

Available inserts

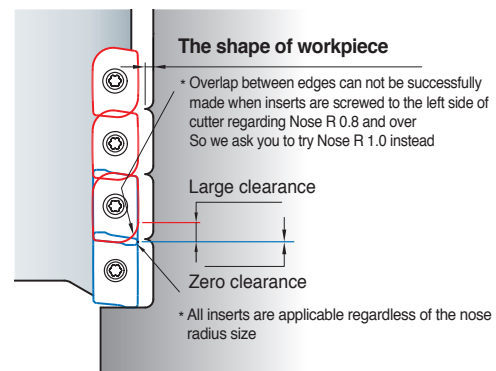


Designation	Cermet		Coated										Uncoated		page			
	CN2500	CN30	NC5330	NCM325	NCM335	NCM535	NCM545	PC2505	PC2510	PC3700	PC6510	PC9530	PC9540	PC5300		PC5400	G10	H01
APMT 1604PDFR-MA																		●
160404PDFR-MA																		
1604PDER-ML														●	●			
160404PDER-ML														●	●			
1604PDSR-MM			●	●		●		●	●	●	●	●	●	●	●			
1604PDSR-MF			●							●	●			●	●			
160410PDSR-MM														●	●			
160416PDSR-MM			●							●				●	●			
160424R-MM			●							●				●	●			
160430R-MM										●				●	●			
160432R-MM			●							●				●	●			
1604PDSR-MN3														●				
1604PDSR-MN4														●				

E06

※ Please purchase 2 types of APMT-MN (nick type) inserts with different chip breakers.
 ※ Please use the cutters with even teeth.

Caution when clamping the inserts

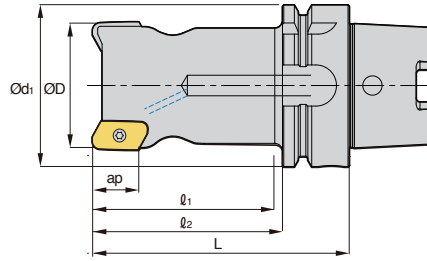


Parts

Specification	 Screw	 Wrench
Ø50~Ø100	FTKA0410	TW15S

Available inserts E06

HSK-XD19 **new**



AA
90°
• AR: 9°~13°
• RR: -11°~13°

(mm)

Designation		ØD	Ød1	l ₁	l ₂	L	ap	
HSK63A- PAV032R-3-100-XD19-A,B	3	32	63	60	74	100	17	0.97
PAV050R-3-100-XD19-A,B	3	50	63	72	74	100	17	1.37

※ Type A uses Insert Nose R 0.4~3.2, and Type B uses Nose R 4.0~5.0

※ When using a spindle at high speed, please check the balance of tool and use it after replacing with the new screw.

Available inserts

XDET-MA



Designation	Cermet		Coated								Uncoated		page	Designation	Cermet		Coated								Uncoated		page									
	CN2500	CN30	NC5330	NCM325	NCM335	NCM335	NCM535	NCM545	PC3700	PC6510	PC9530	PC9540			PC5300	PC5400	PD1005	PD1010	H01	H05	CN2500	CN30	NC5330	NCM325	NCM335	NCM335		NCM535	NCM545	PC3700	PC6510	PC9530	PC9540	PC5300	PC5400	PD1005
XDET 190504PEFR-MA																●	●																	●	●	
190508PEFR-MA																●	●																●	●		
190512PEFR-MA																●	●																●	●		
190516PEFR-MA																●	●																●	●		
190520PEFR-MA																●	●																●	●		
XDET 190524PEFR-MA																●	●																●	●		
190530PEFR-MA																●	●																●	●		
190532PEFR-MA																●	●																●	●		
190540PEFR-MA																●	●																●	●		
190550PEFR-MA																●	●																●	●		

Parts

Specification		
Ø32~Ø50	PTKA0408-A	TW15S

Available inserts E31 Available arbors and bolt E426~E428



E Technical Information for O-ring Cutter

High productivity with optimized grade for high speed machining

O-ring Cutter

- Optimized for grooving the seat of an O-ring in a plastic mold
- Guarantees superior surface roughness compared to HSS and brazed tool
- High productivity with optimized grade for high speed machining
- Reduced time for regrinding and tool alignment
- Special types are available for quotation

Code system

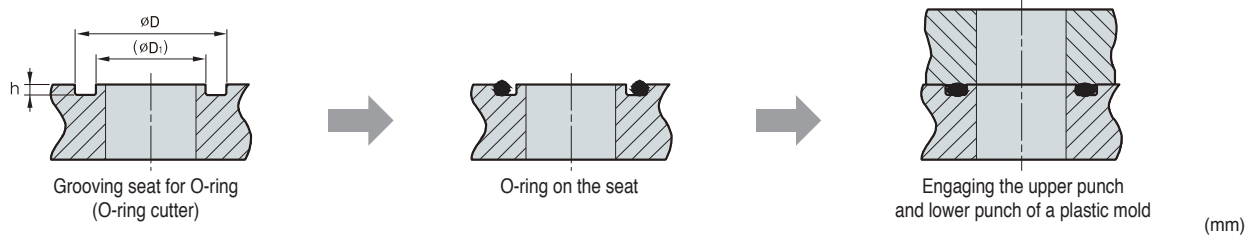
• Insert



• Holder



Grooving and assembly of O-ring



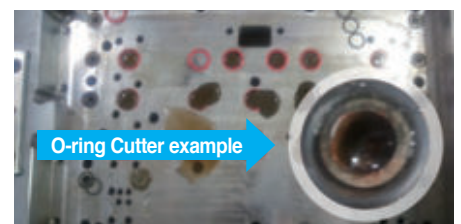
O-ring size	ØD	(ØD ₁)	h ± 0.05
P08	11.0	5.8	1.40
P09	12.0	6.8	
P10	13.0	7.8	
P11	15.0	8.5	
P12	16.0	9.5	
P14	18.0	11.5	
P15	19.0	12.5	1.80
P16	20.0	13.5	
P18	22.0	15.5	
P20	24.0	17.5	
P21	25.0	18.5	
P22	26.0	19.5	
P24	30.0	20.6	2.70
P25	31.0	21.6	

O-ring size	ØD	(ØD ₁)	h ± 0.05
P26	32.0	22.6	2.70
P28	34.0	24.6	
P29	35.0	25.6	
P30	36.0	26.6	
P31	37.0	27.6	
P32	38.0	28.6	
P34	40.0	30.6	
P35	41.0	31.6	
P38	44.0	34.6	
G40	46.0	36.6	
G25	30.0	21.8	2.40
G30	35.0	26.8	
G35	40.0	31.8	
G40	45.0	36.8	

Recommended cutting condition

Workpiece	fz (mm/t)	vc (m/min)
		Coating
		PC3500
Stainless Steel (STS304)	0.03~0.12	60~130
Carbon Steel (SM□□C)	0.05~0.15	80~150
Alloy Steel (SCM)	0.05~0.15	80~150
Hardened Steel (STD, NAK)	0.03~0.12	60~130

Machining Example



ORC



(mm)

Designation		ØD	Ød1	Ød	l	L	Available inserts	O-Ring size	
ORC -	P08	1	11.0	5.7	16	30	150	ORG265	P08
	P09	1	12.0	6.7	16	30	150	ORG265	P09
	P10	1	13.0	7.7	16	30	150	ORG265	P10
	P11	1	15.0	8.5	16	30	150	ORG325	P11
	P12	2	16.0	9.5	16	30	200	ORG325	P12
	P14	2	18.0	11.5	20	30	200	ORG325	P14
	P15	2	19.0	12.5	20	30	200	ORG325	P15
	P16	2	20.0	13.5	20	30	200	ORG325	P16
	P18	2	22.0	15.5	20	30	200	ORG325	P18
	P20	2	24.0	17.5	25	30	200	ORG325	P20
	P21	2	25.0	18.5	25	30	200	ORG325	P21
	P22	2	26.0	19.5	25	30	200	ORG325	P22
	P24	2	30.0	20.6	32	40	250	ORG470	P24
	P25	2	31.0	21.6	32	40	250	ORG470	P25
	P26	2	32.0	22.6	32	40	250	ORG470	P26
	P28	2	34.0	24.6	32	40	250	ORG470	P28
	P29	2	35.0	25.6	32	40	250	ORG470	P29
	P30	2	36.0	26.6	32	40	250	ORG470	P30
	P31	2	37.0	27.6	32	40	250	ORG470	P31
	P32	2	38.0	28.6	32	40	250	ORG470	P32
P34	2	40.0	30.6	42	40	250	ORG470	P34	
P35	2	41.0	31.6	42	40	250	ORG470	P35	
P38	2	44.0	34.6	42	40	250	ORG470	P38	
P40	2	46.0	36.6	42	40	250	ORG470	P40	
ORC -	G25	2	30.0	21.9	32	40	250	ORG405	G25
	G30	2	35.0	26.9	32	40	250	ORG405	G30
	G35	2	40.0	31.9	42	40	250	ORG405	G35
	G40	2	45.0	36.9	42	40	250	ORG405	G40

Available inserts

ORG



Cutter Designation	Designation	Cermet		Coated										Uncoated			page			
		CN2500	CN30	NC5330	NCM325	NCM335	NCM535	NCM545	PC2505	PC2510	PC3700	PC6510	PC9530	PC9540	PC5300	PC5400		ST30A	G10	H01
ORC-P08~P10	ORG 265																			E15
ORC-P11~P22	325																			
ORC-P24~P40	470																			
ORC-G25~G40	405																			

Parts

Specification		
Ø11~Ø26	FTKA0307	TW09S
Ø30~Ø46	FTGA03508	TW15S
Ø30~Ø45		

Available inserts E15

E Technical Information for Chamfer Tool

All applications for chamfers

Chamfer Tool

- All chamfer applications
- Chamfer angles 15°, 30°, 45°, 60° for a variety of customer's needs
- The long cutting-edge provides a wide chamfering range



Back & Front Chamfer Tools



Long Chamfer Tools

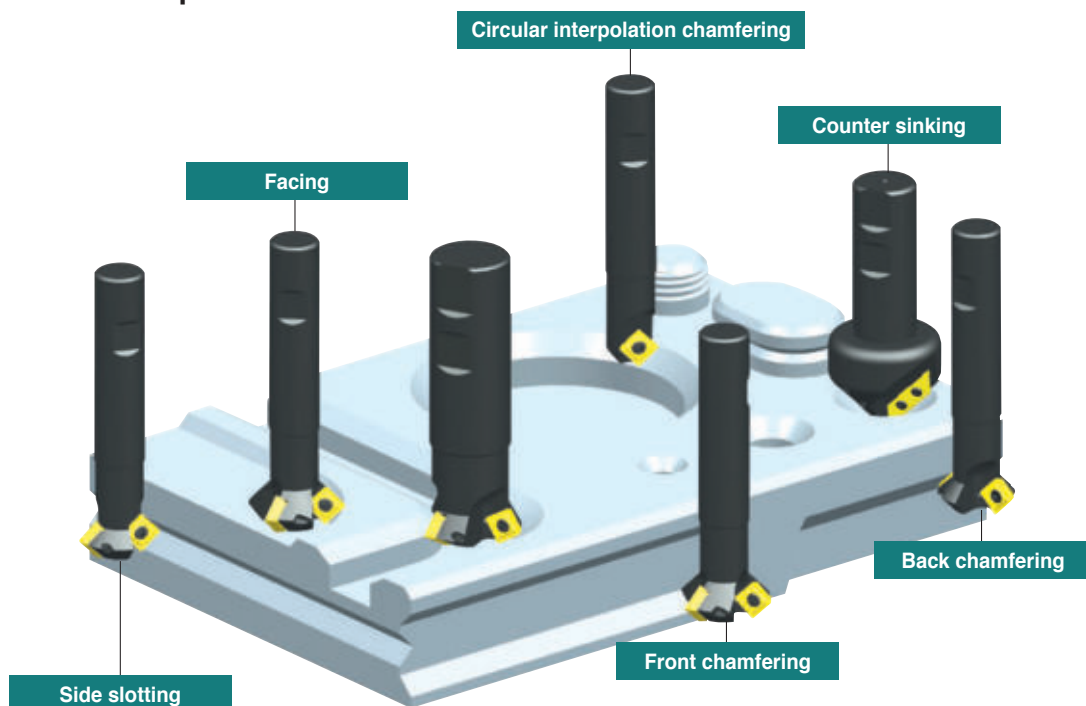
Code system

CE	45	-	11	-	25	-	R	-	S	-	20
Chamfer Endmill	Chamfer angle		Inscribed circle of insert		Min. Cutting Dia.		Hand		Overall length		Shank Dia.
	45°		11: SPMT110408-KC 12: SPMN120308 31: XCET310404ER-KC		Ø25		R: Right L: Left		S: Standard M: Middle L: Long		Ø20

Recommended cutting condition

Workpiece	Grades	ØD (Ø5~Ø20)		ØD (Ø25~Ø35)	
		vc (m/min)	fz (mm/t)	vc (m/min)	fz (mm/t)
P	PC3700	160~270	0.05~0.25	160~270	0.05~0.25
	PC5300	190~310		190~310	
	ST30A	60~100		60~100	
M	PC5300	100~160	0.05~0.20	100~160	0.10~0.30
	PC5400	70~120		70~120	
K	PC5300	110~180	0.10~0.30	110~180	0.30~0.50
	G10	50~90		50~90	

Application example

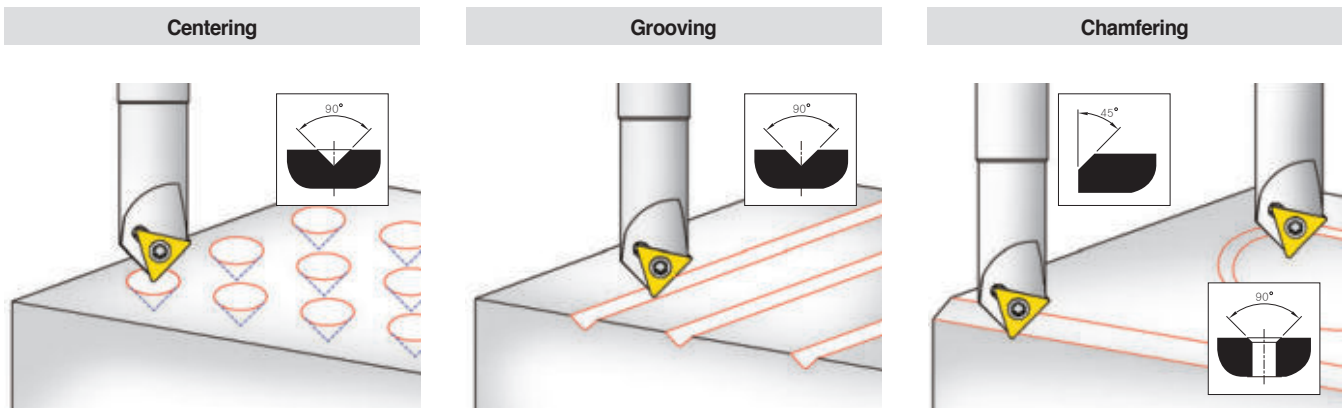


Multi-functional Chamfer Tool

Code system

CE	45	- 16	00	R	- S	20
Chamfer Endmill	Chamfer angle 45°	Inscribed circle of insert 16: TWX16R-KC 22: TWX22R-KC	Min. Cutting Dia. Ø0	Hand R: Right L: Left	Overall length S: 90,110 L: 200	Shank Dia. Ø12 Ø20 Ø25

Application area and recommended cutting condition



Workpiece	Hardness (HRC)	Centering, Grooving		Chamfering	
		vc (m/min)	fz (mm/t)	vc (m/min)	fz (mm/t)
Mild steel, Carbon steel, Alloy steel	Under HRC 30	80~200	0.01~0.04	100~250	0.04~0.06
High Carbon steel, Alloy steel	HRC 30, 40	150~250	0.02~0.06	150~300	0.05~0.10
Aluminum, Copper	-	150~300	0.04~0.08	150~350	0.05~0.10
Cast iron	-	80~150	0.02~0.06	100~250	0.05~0.10
Stainless steel	-	60~120	0.01~0.03	60~150	0.03~0.06
HRSA	-	60~80	0.01~0.03	60~100	0.03~0.06

Note) Please keep fz. backtouch & chipping one caused by wrong fz

Machining example



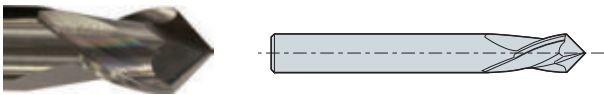
Solid Chamfer Tool

Code system

CCT	090	T	-	080	L
Type	Chamfer angle	Cutting-edge		Diameter	Tool length
CCT: Centering & Chamfering Tool CET: Centering & Chamfering Endmill Tool	060: 60° 090: 90° 120: 120°	None: Single T: Twin		080: Ø8.0	None: Standard L: Long

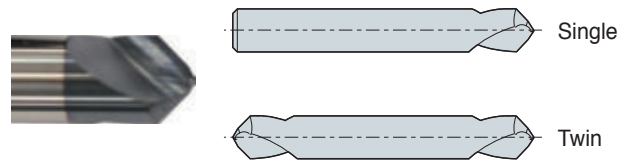
Features

CET (Centering & Chamfering Endmill Tool)



- For internal chamfering up to 0.5 mm
- Can be applied to side milling and easy to regrinding

CCT (Centering & Chamfering Tool)



- Chipping resistance realizes machining in high speed due to double point angle
- Lowers cutting load due to web thinning

CET/CCT Application example

Type	Centering	Hole Chamfering	Chamfering (External)	Chamfering (Internal)	Side milling	Slot milling
Applications (CET)						
60°	×	●	●	●~▲	●	×
90°	▲	●	●	●	●	●~▲
120°	●	●	●	●	●	●
Applications (CCT)						
60°	●	●	●~▲	▲~×	×	×
90°	●	●	●~▲	▲~×	×	×
120°	●	●	●	●	×	●



CE (Back & Front)

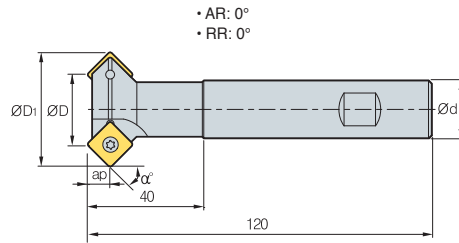


Fig. 1

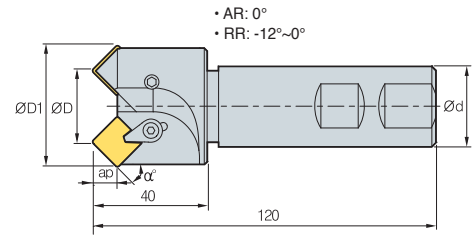


Fig. 2

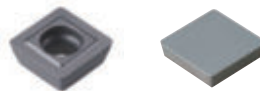


Designation	Number of inserts	$\varnothing D$	$\varnothing D_1$	$\varnothing d$	ap	Fig.	Available inserts	α' (Chamfer angle)		Machining range (Min~Max)	Uses
								Front	Back		
CE	15-1125R-S20	2	25	30.5	20	9.5	SPMT110408-KC	15°	-	$\varnothing 25 \sim \varnothing 30$	Front chamfering
	30-1125R-S20	2	25	35.5	20	8.5		30°	60°	$\varnothing 25 \sim \varnothing 35$	Front, Back chamfering
	45-1107R-S20	1	7	21.9	20	7.0		45°	-	$\varnothing 7 \sim \varnothing 21$	Front chamfering
	45-1119R-S20	2	19	33.9	20	7.0		45°	45°	$\varnothing 19 \sim \varnothing 33$	Front, Back chamfering
	45-1125R-S20	3	25	39.9	20	7.0		45°	45°	$\varnothing 25 \sim \varnothing 39$	Front, Back chamfering
	60-1125R-S32	3	25	43.3	32	5.0		60°	30°	$\varnothing 25 \sim \varnothing 42$	Front, Back chamfering
	45-1207R-S32	1	7	23.3	32	7.8	SPMN120308	45°	-	$\varnothing 7 \sim \varnothing 22$	Front chamfering
	45-1220R-S32	2	20	37.3	32	7.8		45°	-	$\varnothing 21 \sim \varnothing 36$	Front chamfering
	45-1225R-S32	2	25	42.3	32	7.8		45°	-	$\varnothing 26 \sim \varnothing 41$	Front chamfering
	45-1235R-S32	2	35	52.3	32	7.8		45°	-	$\varnothing 36 \sim \varnothing 51$	Front chamfering

(mm)

Available inserts

SPMT-KC SPMN



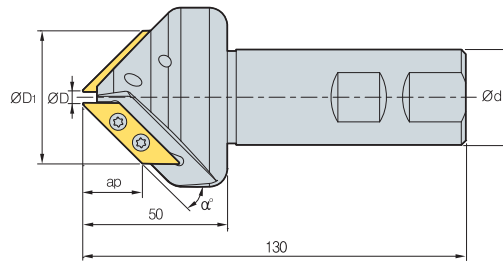
Designation	Cermet		Coated											Uncoated			page	
	CN2500	CN30	NC5330	NCM325	NCM335	NCM535	NCM545	PC2505	PC2510	PC3700	PC6510	PC9530	PC9540	PC5300	PC5400	ST30A		G10
SPMT 110408-KC										●						●	●	
SPMN 120308																●		

Parts

Specification	Screw	Clamp	C-Ring	Wrench	Wrench
$\varnothing 7 \sim \varnothing 25$ (1100 type)	FTKA0408	-	-	TW15S	-
$\varnothing 7 \sim \varnothing 35$ (1200 type)	CHX0617L	CH6R2	CR05	-	HW30L

Available inserts E27

CE (Long chamfer)



• AR: $-5^{\circ}\sim 1^{\circ}$
• RR: 0°

(mm)

Designation		ØD	ØD ₁	Ød	ap	α° (Chamfer angle)	Machining range (Min~Max)	Uses
CE 30-3105R-S32	1	5	35	32	26	30°	Ø5~Ø35	Front Chamfering
45-3105R-S32	2	5	48	32	21	45°	Ø5~Ø48	Front Chamfering
60-3105R-S32	2	5	57	32	15	60°	Ø5~Ø57	Front Chamfering

Available inserts

XCET-KC



Designation	Cermet		Coated										Uncoated			page			
	CN2500	CN30	NC5330	NCM325	NCM335	NCM535	NCM545	PC2505	PC2510	PC3700	PC6510	PC9530	PC9540	PC5300	PC5400		ST30A	G10	H01
XCET 310404ER-KC										●						●	●		E31

Parts

Specification		
Ø5	FTKA03510	TW15S

Available inserts E31



CE (Multi-functional)

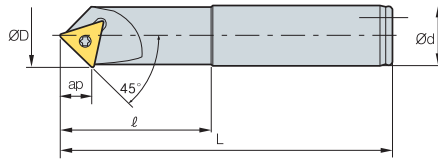


Fig. 1

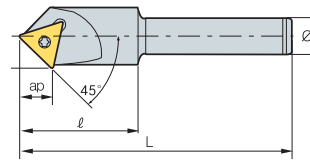


Fig. 2



• AR: -12°~15°
• RR: 0°

(mm)

Designation	ØD	Ød	ℓ	L	ap	Fig.	Available Inserts	Machining range (Min~Max)	Uses	
CE	45-1600R-S12	21.2	12	40	90	10	2	TWX16R-KC	Ø0 ~ Ø20	Centering Grooving Chamfering
	45-1600R-S20	21.2	20	50	110	10	1	TWX16R-KC	Ø0 ~ Ø20	
	45-1600R-L20	21.2	20	60	200	10	1	TWX16R-KC	Ø0 ~ Ø20	
	45-2200R-S12	28.8	12	40	90	14	2	TWX22R-KC	Ø0 ~ Ø27	
	45-2200R-S25	28.8	25	50	110	14	1	TWX22R-KC	Ø0 ~ Ø27	
	45-2200R-L25	28.8	25	60	200	14	1	TWX22R-KC	Ø0 ~ Ø27	

Available inserts

TWX-KC



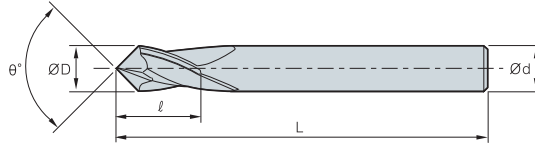
Designation	Cermet		Coated										Uncoated			page			
	CN2500	CN30	NC5330	NCM325	NCM335	NCM535	NCM545	PC2505	PC2510	PC3700	PC6510	PC9530	PC9540	PC5300	PC5400		ST30A	G10	H01
TWX 16R-KC										●				●					E29
TWX 22R-KC									●										

Parts

Specification	 Screw	 Wrench
Ø22~Ø29	FTNA0408	TW15L

Available inserts E29

CET



(mm)

Designation	ØD	Ød	ℓ	L	θ°
CET060 -	030	3	3	5.5	60°
	040	4	4	7	
	060	6	6	10	
	080	8	8	13	
	100	10	10	16	
	120	12	12	18	
	160	16	16	24	
CET090 -	030	3	3	5.5	90°
	040	4	4	7	
	060	6	6	10	
	080	8	8	13	
	100	10	10	16	
	120	12	12	18	
	160	16	16	24	
CET120 -	030	3	3	5.5	120°
	040	4	4	7	
	060	6	6	10	
	080	8	8	13	
	100	10	10	16	
	120	12	12	18	
	160	16	16	24	



CCT

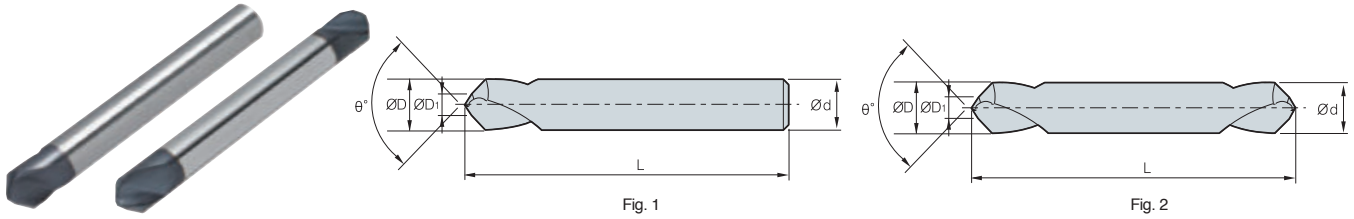


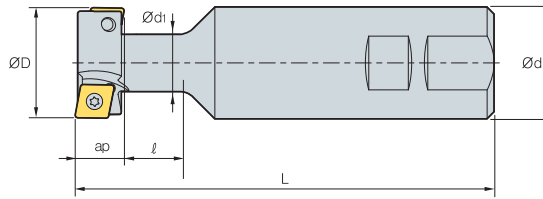
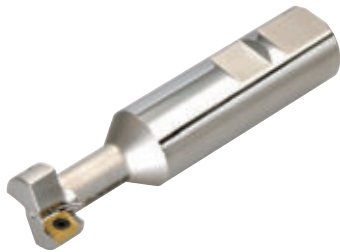
Fig. 1

Fig. 2

(mm)							
Designation		$\text{ØD} = \text{Ød}$	ØD_1	L	θ°	Fig.	
CCT060 -	030	3	1.0	40	60°	1	
	040	4	1.5	40			
	060	6	2.0	50			
	080	8	2.5	60			
	100	10	3.0	70			
	120	12	4.0	80			
	160	16	5.0	100			
CCT060T -	030	3	1.0	40		60°	2
	040	4	1.5	40			
	060	6	2.0	50			
	080	8	2.5	60			
	100	10	3.0	70			
	120	12	4.0	80			
	160	16	5.0	100			
CCT060T -	030L	3	1.0	100	90°		1
	040L	4	1.5	100			
	060L	6	2.0	100			
	080L	8	2.5	120			
	100L	10	3.0	120			
	120L	12	4.0	150			
CCT090 -	030	3	1.0	40		90°	1
	040	4	1.5	40			
	060	6	2.0	50			
	080	8	2.5	60			
	100	10	3.0	70			
	120	12	4.0	80			
	160	16	5.0	100			
CCT090T -	030	3	1.0	40	90°		2
	040	4	1.5	40			
	060	6	2.0	50			
	080	8	2.5	60			
	100	10	3.0	70			
	120	12	4.0	80			
	160	16	5.0	100			
CCT090T -	030L	3	1.0	100		120°	1
	040L	4	1.5	100			
	060L	6	2.0	100			
	080L	8	2.5	120			
	100L	10	3.0	120			
	120L	12	4.0	150			
CCT120 -	030	3	1.0	40	120°		1
	040	4	1.5	40			
	060	6	2.0	50			
	080	8	2.5	60			
	100	10	3.0	70			
	120	12	4.0	80			
	160	16	5.0	100			
CCT120T -	030	3	1.0	40		120°	2
	040	4	1.5	40			
	060	6	2.0	50			
	080	8	2.5	60			
	100	10	3.0	70			
	120	12	4.0	80			
	160	16	5.0	100			
CCT120T -	030L	3	1.0	100	120°		1
	040L	4	1.5	100			
	060L	6	2.0	100			
	080L	8	2.5	120			
	100L	10	3.0	120			
	120L	12	4.0	150			



TFE



AA
90°
• AR: 5°
• RR: -5°

(mm)

Designation		ØD	Ød	Ød ₁	ℓ	L	ap	Available inserts	
TFE	2125R/L	2	21	25	10.5	20	109	9	CPMT06
	2525R/L	2	25	25	12.5	21	112	11	CPMT08
	3232R/L	2	32	32	16.5	26	120	14	CPMT09
	4032R/L	2	40	32	20.5	32	130	18	CPMH12
	5032R/L	4	50	32	26.5	38	140	22	CPMH12

Available inserts

CPMT CPMH

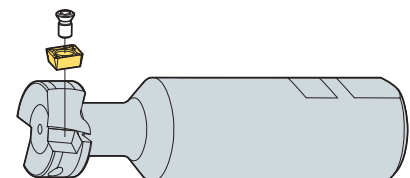


Designation	Cermet		Coated										Uncoated			page		
	CN2500	CN30	NC5330	NCM325	NCM335	NCM535	NCM545	PC2505	PC2510	PC3700	PC6510	PC9530	PC9540	PC5300	PC5400		ST30A	G10
CPMT 060204-MM										●								
080308-MM										●								
09T308-MM										●								
CPMH 120408-MM										●								

Parts

Specification	Screw	Wrench
Ø21	FTNA02555	TW08S
Ø25	FTNA0306	TW09S
Ø32	FTNA0407	TW15S
Ø40	PTMA0511A	TW15S
Ø50		

Assembling



Available inserts E08

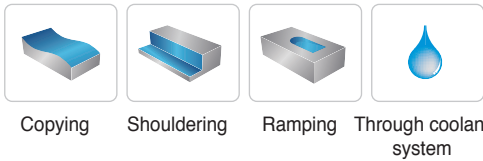


Inserts feature a buffed top surface ensuring better chip control and reducing built-up edge

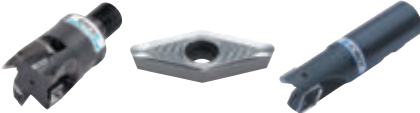

Pro-A Mill

- Buffed top face of insert ensures good chip control and reduces built-up edge
- Small size modular type for aluminum machining
- Various line up of modular system for aluminum machining
- For shouldering, curved surface and ramping
- High rake angle chip breaker ensures excellent surface roughness, improved cooling effects, and chip control by through coolant system, even in deep pocket machining

Uses



Pro-A Mill series

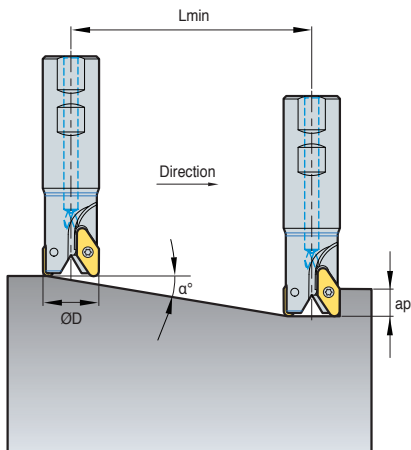
Type	Available inserts and tool holders	Through coolant system
Application of small-sized Aluminum machining	 <ul style="list-style-type: none"> • Modular: $\varnothing 12 \sim \varnothing 42$ • Shank: $\varnothing 12 \sim \varnothing 42$ • Insert: VDKT11T210N-MA VDKT11T220N-MA 	○
General application of Aluminum machining	 <ul style="list-style-type: none"> • cutter: $\varnothing 40 \sim \varnothing 100$ • Shank: $\varnothing 32 \sim \varnothing 40$ • Insert: VCKT220530N-MA 	○

Recommended cutting condition

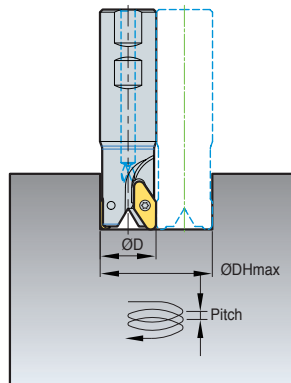
Workpiece		Cutting speed v_c (m/min)
Aluminum alloy	Rm < 280 MPa	1000
	Rm > 280 MPa	800
Copper alloy	Long chip	250
Thermo plastic	-	300
Aluminum alloy	Si < 12%	800
Copper alloy	Short chip	400
Magnesium alloy	-	400
Duroplastics	-	150

Pro-A Mill ramping & helical cutting technical data

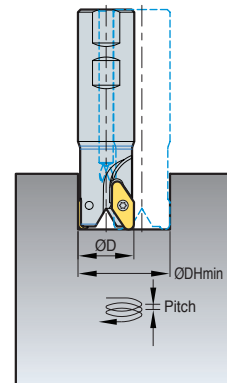
1. Ramping



2. Blind hole helical cutting



3. Thru hole helical cutting



(mm)

Designation	ØD	Ramping		Blind hole helical cutting				Thru hole helical cutting	
		α°	Lmin	ØDHmin	dmax	ØDHmax	dmax	ØDHmin	dmax
PAS2012HR	12	11.9	38	21	4.4	23	4.8	19	4.0
PAS2016HR	16	12.5	36	29	6.4	31	6.9	27	6.0
PAS2020HR	20	9.7	47	37	6.3	39	6.7	35	6.0
PAS2025HR	25	7.6	60	47	6.3	49	6.5	45	6.0
PAS2032HR	32	5.8	79	61	6.2	63	6.4	59	6.0
PAS2042HR	42	4.3	105	81	6.2	83	6.3	79	6.0
PAS4032HR	32	24.4	22	54	15.0	59	26.8	40	15.0
PAS4040HR	40	18.4	30	70	15.0	75	25.0	56	15.0
PAS4050HR	50	14.0	40	90	15.0	95	23.8	76	15.0
PAS4063HR	63	10.7	53	116	15.0	121	22.8	102	15.0
PAC(M)4080HR	80	8.1	70	150	15.0	155	22.1	136	15.0
PAC(M)4100HR	100	6.3	90	190	15.0	195	21.7	176	15.0

- Lmin: When ap = 8 mm
- Lmin: Minimum inclination cutting length
- α°: Max. rampig angle
- ap: Depth of cut

$$Lmin = \frac{ap}{\tan \alpha^\circ} \text{ (mm)}$$

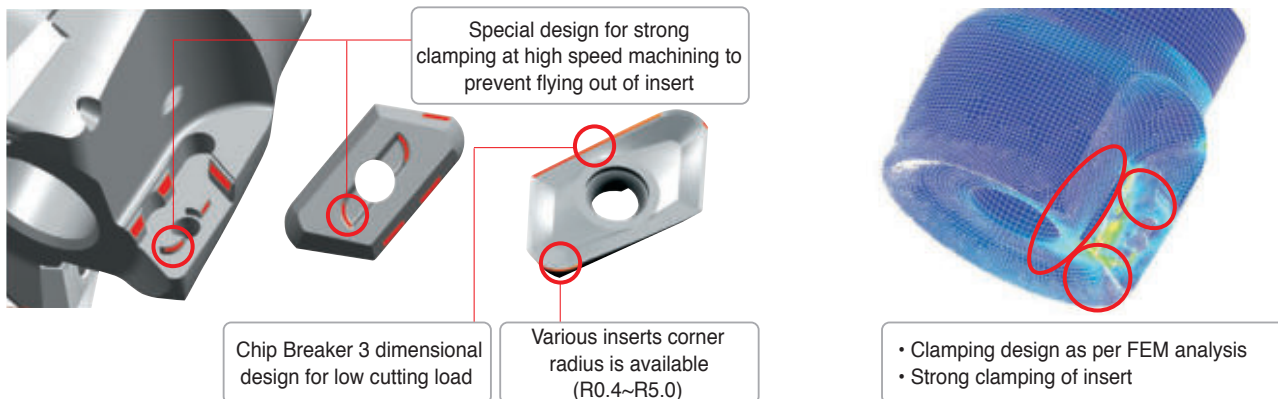


Features a strong clamping provided by the concave grooves on the back surface of the inserts

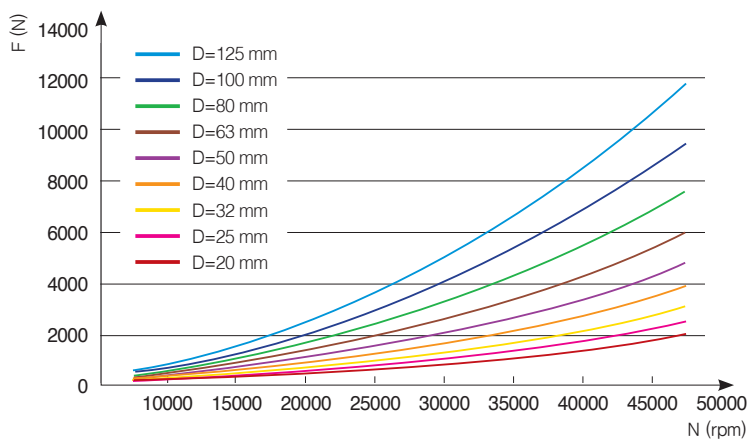
Pro-X Mill

- Inserts feature a buffed top surface ensuring a smoother chip evacuation and reducing built-up edge
- High rake angle of insert provides good surface finish and low cutting load
- Specially designed for high speed machining of aluminum
- Suitable for square shouldering and curved surface machining

Clamping system for high speed



Centrifugal force as per RPM



※ Screw Torque = 4 N·m
※ Indexable insert: 6.8g

Marking [• Designation • Max. RPM]



Max. RPM as per cutting diameter

Cutting diameter ØD (mm)	5000 type		6000 type	
	n (min ⁻¹)	vc (m/min)	n (min ⁻¹)	vc (m/min)
20	14,000	879	-	-
25	28,000	2,199	15,000	1,178
32	25,000	2,513	23,000	2,312
40	22,000	2,764	20,000	2,513
50	20,000	3,141	18,000	2,827
63	18,000	3,562	16,000	3,166
80	16,000	4,021	14,000	3,518
100	14,000	4,398	13,000	4,084
125	13,000	5,105	11,000	4,319

※ In case of actual machining accidental breakage of insert or tool could happen even under the written RPM special cover or door is necessary to prevent damage from broken insert or broken tool

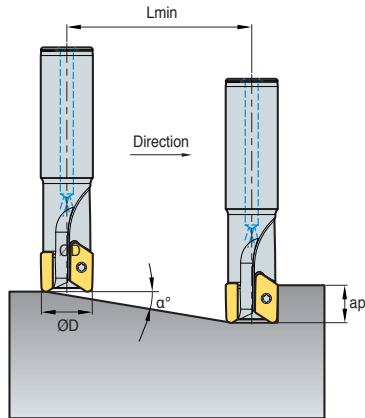
Recommended cutting condition

Workpiece		Cutting Speed vc (m/min)	Feed fz (mm/t)
Aluminum alloy	Rm280 < MPa	1200	0.30
	Rm280 > MPa	1000	0.25
Copper alloy	Long chipping	400	0.20
	Thermo plastic	350	0.15
Aluminum alloy	Si < 12%	1000	0.25
	Si ≥ 12%	300	0.23
Copper alloy	Short chipping	500	0.20
Magnesium alloy	-	450	0.20
Duroplastics	-	200	0.15

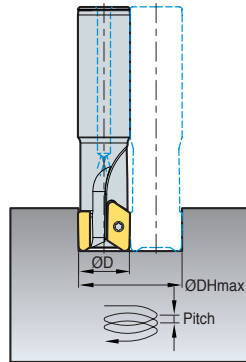
E Technical Information for Pro-X Mill

Pro-X Mill ramping & helical cutting technical data

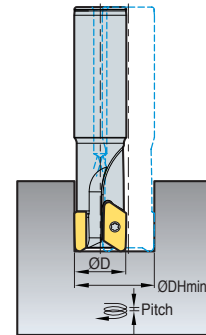
1. Ramping



2. Blind hole helical cutting



3. Thru hole helical cutting



(mm)

Designation	ØD	Ramping		Blind hole Helical cutting				Thru hole Helical cutting	
		α°	Lmin	ØDHmin	dmax	ØDHmax	dmax	ØDHmin	dmax
PAXS5020HR	20	8.4	68	32	4.7	34	5.0	27	4.0
PAXS5025HR	25	13.2	43	42	9.9	44	10.4	34	8.0
PAXS5032HR	32	9.5	60	56	9.3	58	9.7	48	8.0
PAXS5040HR	40	7.1	80	72	9.0	74	9.3	64	8.0
PAXCM5050HR	50	5.4	105	92	8.8	94	9.0	84	8.0
PAXCM5063HR	63	4.2	138	118	8.6	120	8.7	110	8.0
PAXC(M)5080HR	80	3.2	180	152	8.4	154	8.6	144	8.0
PAXC(M)5100HR	100	2.5	230	192	8.3	194	8.4	184	8.0
PAXC(M)5125HR	125	2.0	293	242	8.3	244	8.3	234	8.0
PAXS6025HR	25	9.0	63	42	6.6	44	6.9	38	6.0
PAXS6032HR	32	6.6	87	56	6.5	58	6.7	52	6.0
PAXS6040HR	40	12.1	47	72	15.4	74	15.9	56	12.0
PAXCM6050HR	50	9.0	63	92	14.5	94	14.8	76	12.0
PAXCM6063HR	63	6.7	85	118	13.9	120	14.1	102	12.0
PAXC(M)6080HR	80	5.0	113	152	13.4	154	13.6	136	12.0
PAXC(M)6100HR	100	3.9	147	192	13.1	194	13.2	176	12.0
PAXC(M)6125HR	125	3.0	188	242	12.8	244	13.0	226	12.0

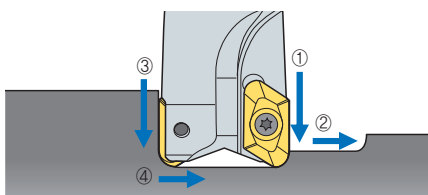
• Lmin: When ap = 10mm

• Lmin: Minimum inclination cutting length $Lmin = \frac{ap}{\tan \alpha^\circ}$ (mm)

α°: Max. ramping angle

ap: Depth of cut

Plunging, slotting, drilling technical data



1. When drilling, grooving machining sequence is

① → ② → ③ → ④

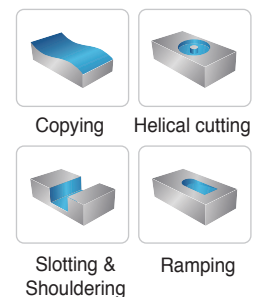
2. When drilling, grooving, decrease the feed and cutting speed 30%~50% from the recommended data

• Cutting condition for drilling

Holder	ap (mm)	
	5000 type	6000 type
Ø20	8	-
Ø25	4	11
Ø32	4	6
Ø40~125	4	6

Insert	ap (mm)
XETK19	4
XETK25	6

• Uses

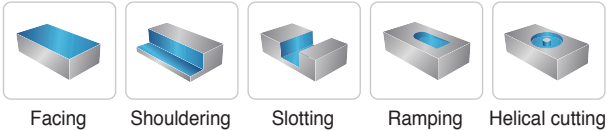


New indexable milling tool for the machining of high quality workpieces

Pro-L Mill

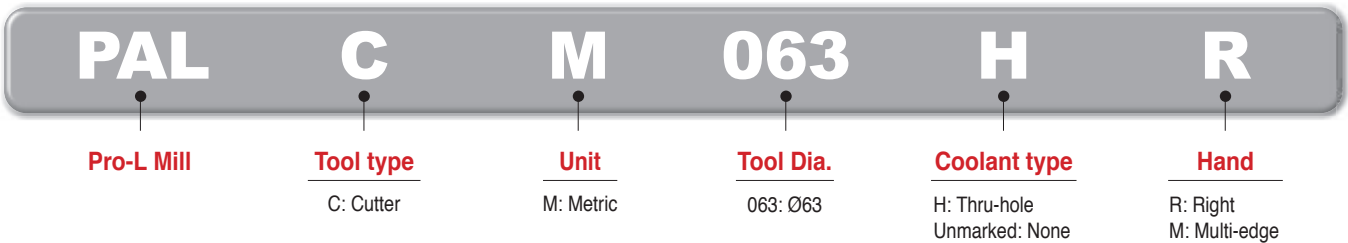
- Improved perpendicularity and lower cutting resistance due to the combined design of the clearance face and high helix edge of these inserts
- Productivity increase due to more than half as much of depth of cut comparing to existing product
- Strong clamping design by adaption of double screw on system
- Improved chip flow due to helical type design of chip pocket and application of coolant system

Uses

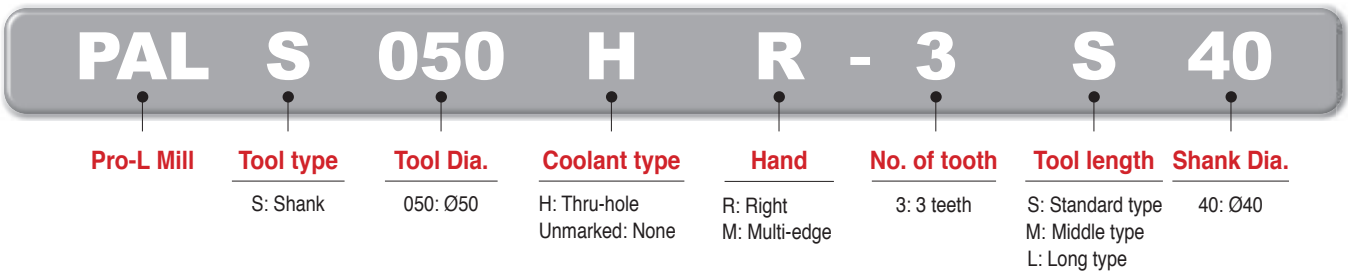


Code system

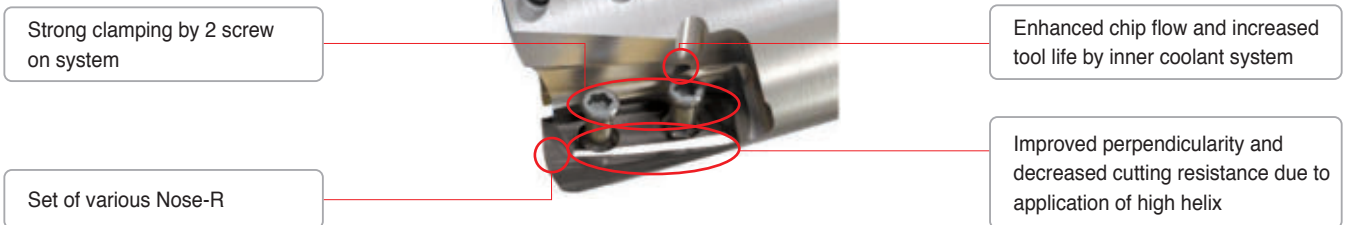
• Cutter



• Shank



Features



Features of chip breakers

Insert	Cutting-edge	Uses	Features
MA		Al	Edge optimized for aluminum machining and buffed finish ensuring an excellent machining quality
ML		Hard-to-cut material	Design of low cutting resistance chip breaker ensures excellent machining quality for light cutting and hard-to-cut material

Selection of grades and chip breaker

Category	M (Stainless steel)	N (Aluminum alloy)	S (HRSA)
Grades	PC5300/PC5400	H01	PC5300/PC5400
MA	-	○	-
ML	○	-	○

Application examples

Al6061 (HRC30)

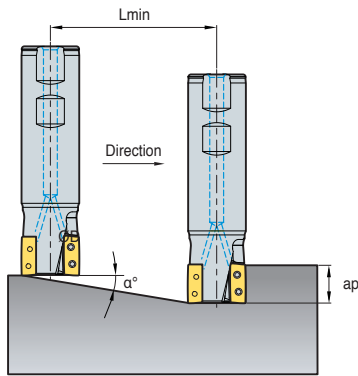
Cutting condition

vc = 500 m/min, fz = 0.2 mm/t, ap = 30~60 mm,
ae = 1~5 mm (finishing: 1 mm, roughing: 5 mm), z = 3

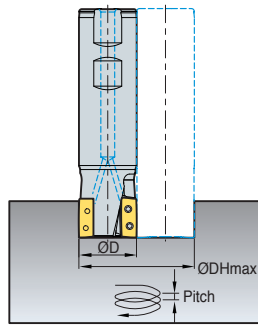


Pro-L Mill ramping & helical cutting technical data

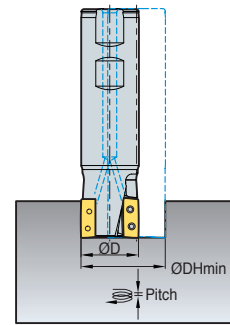
1. Ramping



2. Blind hole helical cutting



3. Thru hole helical cutting



(mm)

Designation	ØD	Ramping		Blind hole helical cutting				Thru hole helical cutting	
		α°	Lmin	ØDHmin	dmax	ØDHmax	dmax	ØDHmin	dmax
PALS032HR-2S20	32	3.37	170	60	3.5	62	3.6	55	3.2
PALS032HR-2S25	32	3.37	170	60	3.5	62	3.6	55	3.2
PALS032HR-2S32	32	3.37	170	60	3.5	62	3.6	55	3.2
PALS040HR-2S32	40	2.12	270	76	2.8	78	2.9	71	2.6
PALS040HR-2S40	40	2.12	270	76	2.8	78	2.9	71	2.6
PALS040HR-2S42	40	2.12	270	76	2.8	78	2.9	71	2.6
PALS040HR-3S32	40	2.12	270	76	2.8	78	2.9	71	2.6
PALS040HR-3S40	40	2.12	270	76	2.8	78	2.9	71	2.6
PALS040HR-3S42	40	2.12	270	76	2.8	78	2.9	71	2.6
PALS050HR-3S32	50	2.08	275	96	3.5	98	3.6	91	3.3
PALS050HR-3S40	50	2.08	275	96	3.5	98	3.6	91	3.3
PALS050HR-3S42	50	2.08	275	96	3.5	98	3.6	91	3.3
PALS063HR-4S32	63	1.76	325	122	3.8	124	3.8	117	3.6
PALS063HR-4S40	63	1.76	325	122	3.8	124	3.8	117	3.6
PALS063HR-4S42	63	1.76	325	122	3.8	124	3.8	117	3.6
PALS063HM-4S32	63	1.76	325	122	3.8	124	3.8	117	3.6
PALS063HM-4S40	63	1.76	325	122	3.8	124	3.8	117	3.6
PALS063HM-4S42	63	1.76	325	122	3.8	124	3.8	117	3.6
PALCM063HR	63	1.76	325	122	3.8	124	3.8	117	3.6

• Lmin: When ap = 10 mm

• Lmin: Minimum inclination cutting length

$$Lmin = \frac{ap}{\tan \alpha^\circ} \text{ (mm)}$$

α° : Max. ramping angle

ap : Depth of cut



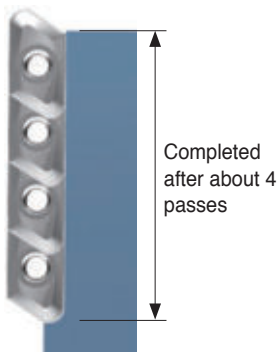
Deep cutting milling tools to maximize productivity in aluminum machining

Pro-XL Mill **new**

- **Productivity** - Cutting time is shortened by finishing the process with a single pass of deep shouldering in aluminum machining
- **High quality** - Shouldering within a single pass enables walls with perfect perpendicularity
- **Clamping stability** - Two-Screw On system secures clamping stability

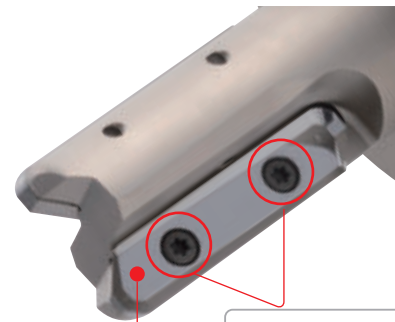
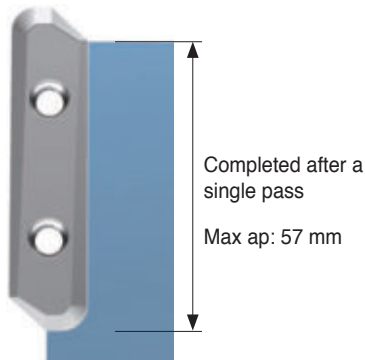
Features of Pro-XL Mill

Existing cutters



- 4 times shorter cutting time
- Satisfactory surface finish of side faces with no need for further processing

Pro-XL Mill



Powerful Two-Screw On system

Improved chip flow and inhibited built-up edges thanks to mirror-like finishing of inserts

Application examples

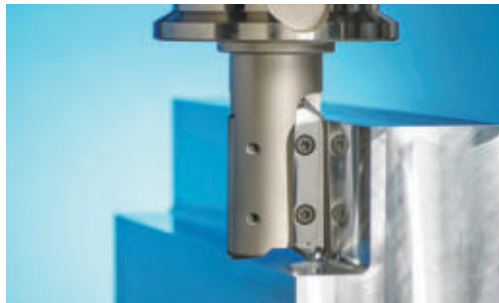
Al7075

■ Cutting condition

vc = 500 m/min, fz = 0.25 mm/t
ap = 56 mm, ae = 1 mm
z = 2

■ Tools

Insert LDET650550PPFR-MA
Grades H01
Holder BT50-PXL04090HR-2F (ØD = 40 mm)



E Technical Information for Pro-V Mill

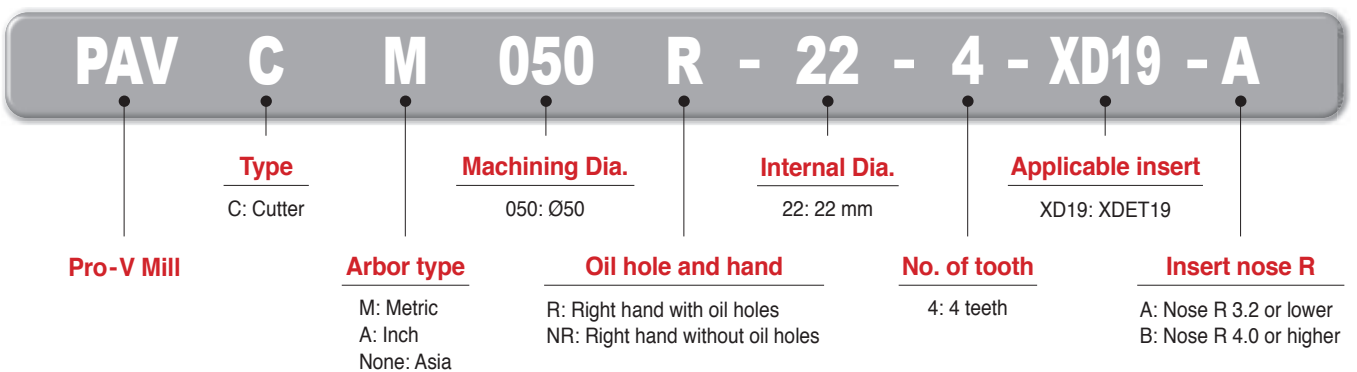
The Premium High-Speed Milling Tool for Aluminum

Pro-V Mill new

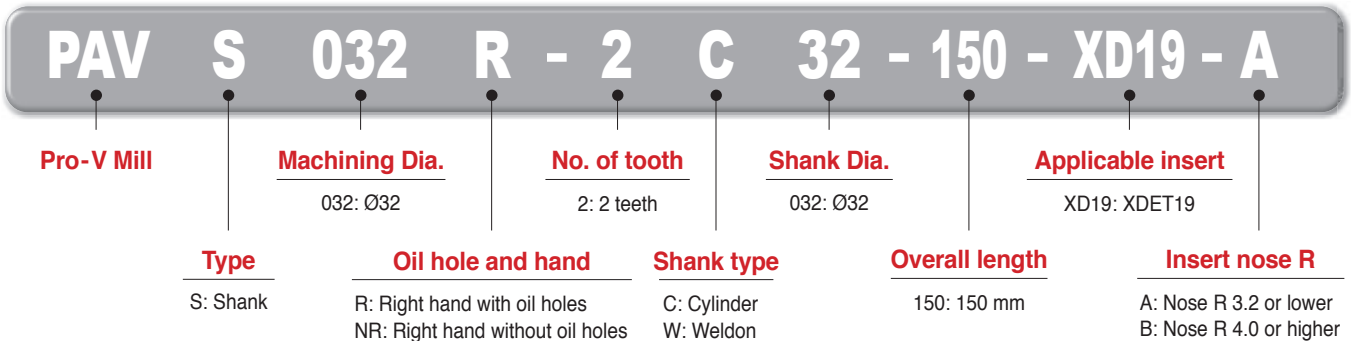
- **Enhanced productivity**- Increased productivity due to high speed capability
- **Improved surface finish**- Excellent surface finish and perpendicularity with high-precision products
- **Excellent clamping stability**- Satisfactory clamping force of inserts by the use of the key shape

Code system

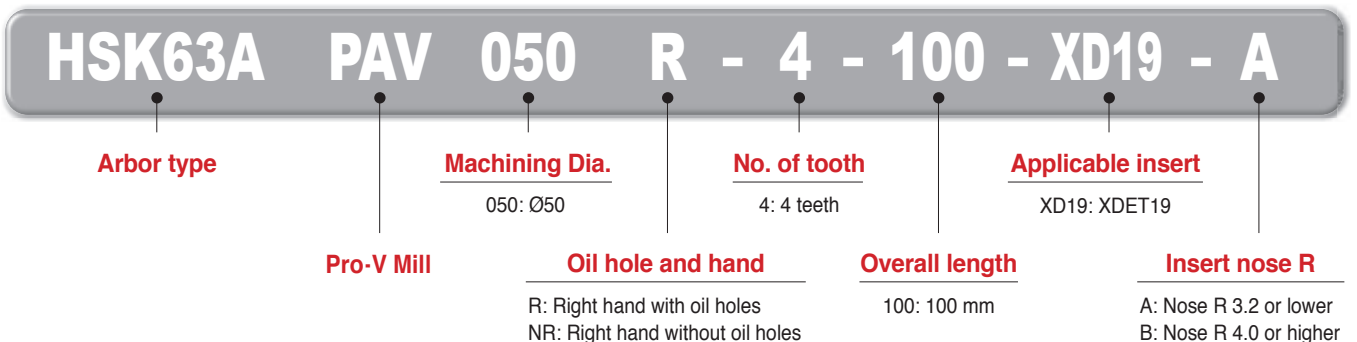
• Cutter



• Shank

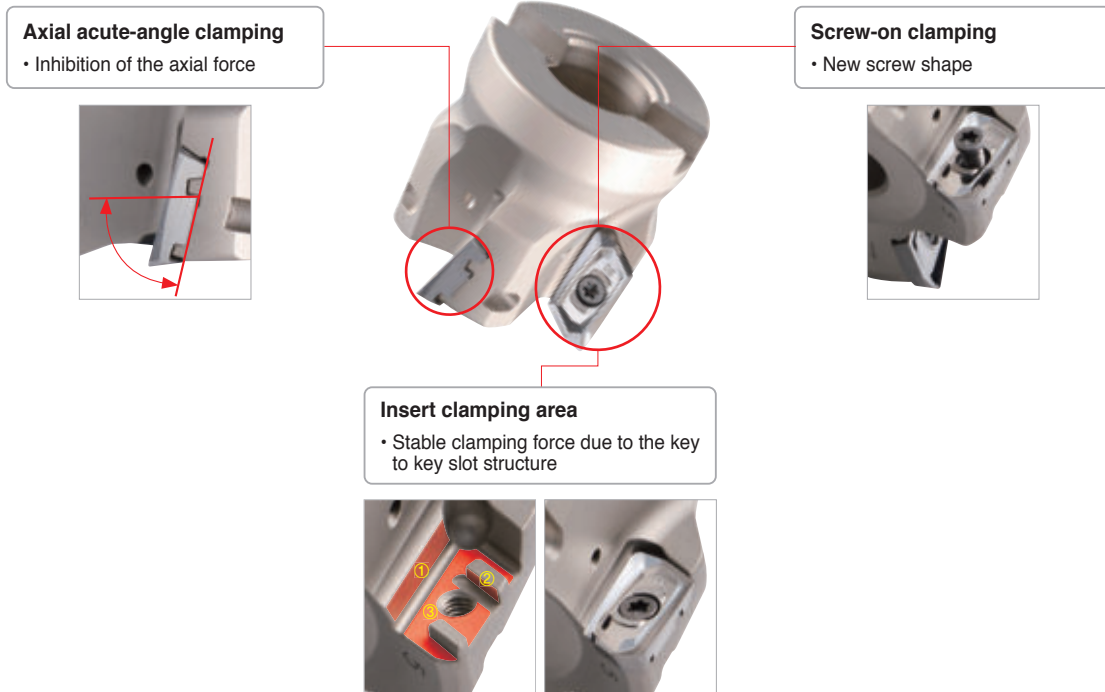


• Tooling System

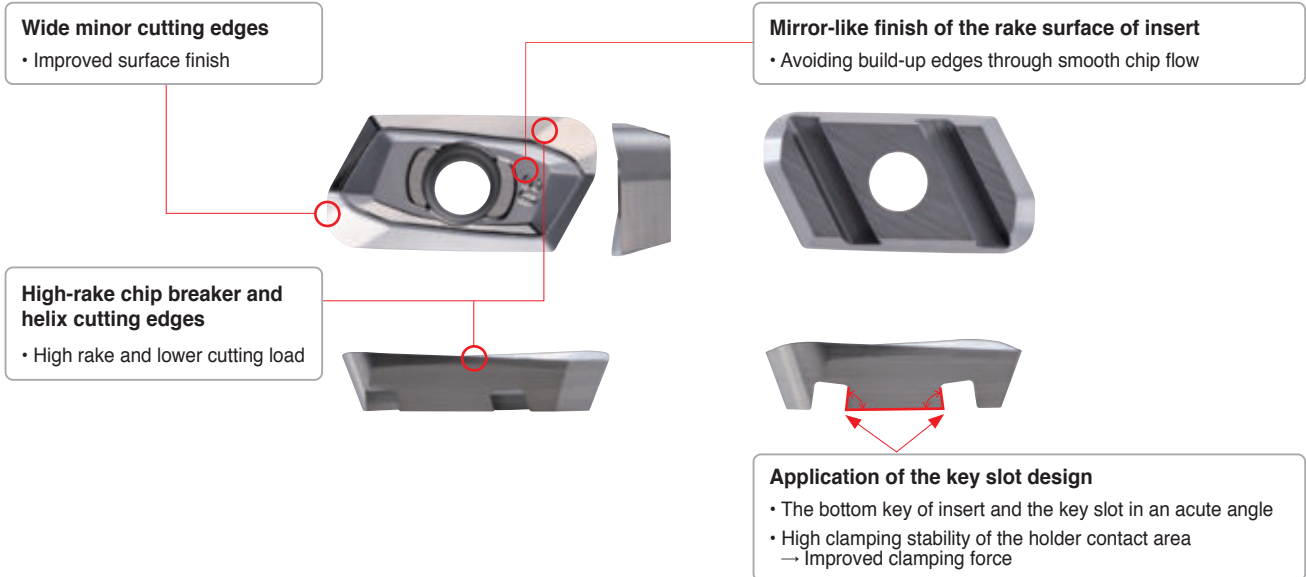


➤ Cutter Features

- The combined clamping system of the key to key slot structure and simple screw-on type ensures strong clamping force
 - Stable machining / prevention of insert breakage
- Avoiding uplifting problems of insert due to axial acute-angle clamping of cutters
 - Reduced vibrations and excellent surface finish



➤ Insert Features



➤ Features of chip breaker

Insert	Cutting-edge	Uses	Features
MA		For non-ferrous metals	Ensuring satisfactory machining quality with the application of mirror-like cutting edges optimized for aluminum machining

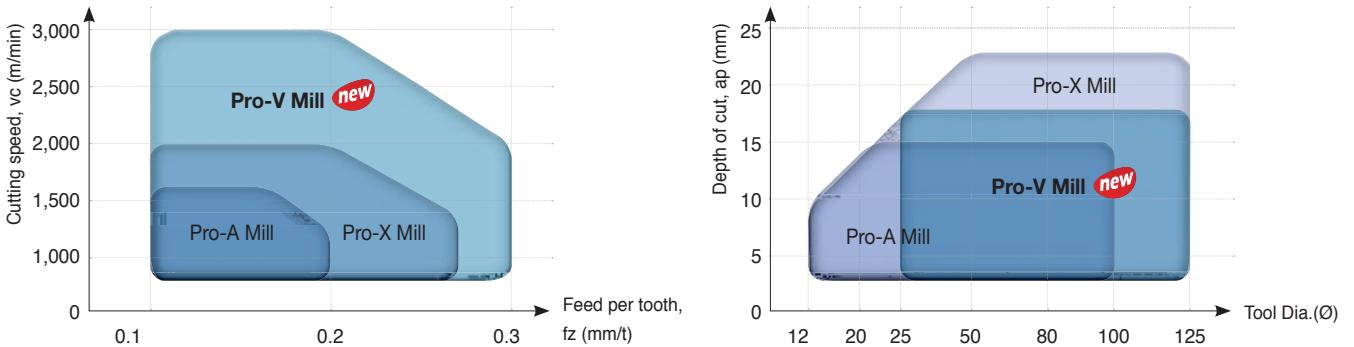
E Technical Information for Pro-V Mill

Recommended cutting condition

Workpiece		Grade	vc (m/min)	Max. ap (mm)
N	Aluminum	Si ≤ 5% (Si Lower than 5%)	H01	1,300 (500 - 2,200)
			H05	1,000 (300 - 1,700)
			PD1005	1,500 (500 - 3,000)
		Si ≤ 10% (Si Lower than 10%)	PD1010	1,200 (300 - 2,200)
				17

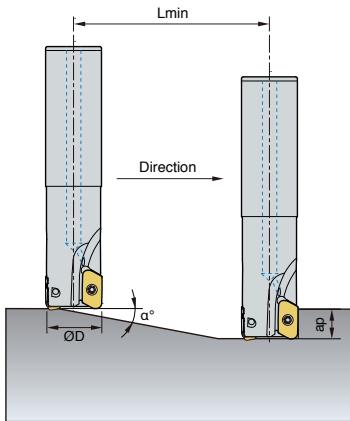
* The recommended cutting conditions above are a general guideline. Their details may vary depending on the machining method of users and other conditions.

Application area

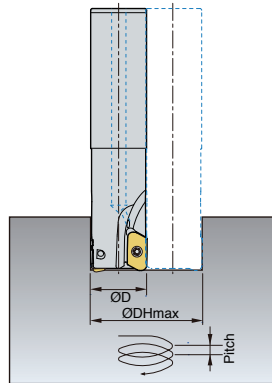


Pro-V Mill ramping & helical cutting technical data

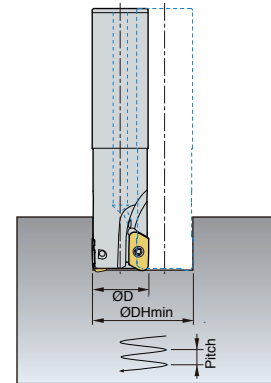
1. Ramping



2. Blind hole helical cutting



3. Thru hole helical cutting



(mm)

ØD	Ramping		Blind hole helical cutting				Thru hole helical cutting	
	α°	Lmin	ØDHmin	dmax	ØDHmax	dmax	ØDHmin	dmax
25	15.0	59	41	13.0	44	15.5	27	2.0
32	10.0	99	55	11.0	58	12.5	41	4.5
40	7.0	142.5	71	10.5	74	11.5	57	6.0
50	5.0	200	91	10.0	94	10.5	77	6.5
63	3.5	286	117	9.2	120	9.5	103	7.0
80	2.6	385	151	9.0	154	9.5	137	7.3
100	2.0	501	191	9.0	194	9.0	177	7.6
125	1.5	668	241	8.5	244	8.5	227	7.5

• When ramping and helical milling, table feed, vf (mm/min) should be lower than 70% of the recommended cutting conditions.

• When helical milling, Max. pitch, DHmax should be lower than max. depth of cut, ap.

• When ramping, the depth of cut should be lower than max. depth of cut, ap.

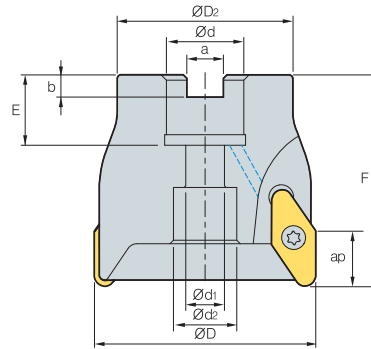
• Lmin: $ap/\tan(\alpha^\circ)$ (mm)

• Lmin: Minimum inclination cutting length
α° : Max. ramping angle

ap : Depth of cut



PAC(M)2000/4000



(mm)

Designation		ØD	ØD2	Ød	Ød1	Ød2	a	b	E	F	ap		
PACM	2040HR	3	40	34	16	9	14	8.4	5.6	18	40	8.7	0.2
	2050HR	4	50	42	22	11	18	10.4	6.3	22	50	8.7	0.4
	2063HR	5	63	49	22	11	18	10.4	6.3	22	50	8.7	0.6
	2080HR	5	80	57	27	14	20	12.4	7.0	25	50	8.7	0.9
	2100HR	6	100	67	32	18	26	14.4	8.0	30	63	8.7	1.9
	4040HR	3	40	32	16	9	11.5	8.4	5.6	20	55	15	0.2
	4050HR	3	50	40	22	11	18	10.4	6.3	20	55	15	0.3
	4063HR	4	63	50	22	11	18	10.4	6.3	20	60	15	0.6
	4080HR	4	80	60	27	14	20	12.4	7.0	25	60	15	1.0
	4100HR	5	100	80	32	18	26	14.4	8.0	26	60	15	1.6
PAC	2080HR	5	80	57	25.4	14	20	9.5	6.0	25	50	8.7	0.9
	2100HR	6	100	67	31.75	-	44	12.7	8.0	37	63	8.7	1.9
	4080HR	4	80	60	25.4	14	20	9.5	6.0	25	60	15	1.0
	4100HR	5	100	80	31.75	-	44	12.7	8.0	37	60	15	1.6

Available inserts

VCKT-MA



Type	Designation	Cermet		Coated										Uncoated			page			
		CN2500	CN30	NC5330	NCM325	NCM335	NCM535	NCM545	PC2505	PC2510	PC3700	PC6510	PC9530	PC9540	PC5300	PC5400		ST30A	G10	H01
2000 type	VDKT 11T210N-MA																		●	E29
4000 type	VCKT 220530N-MA																		●	

Available arbors

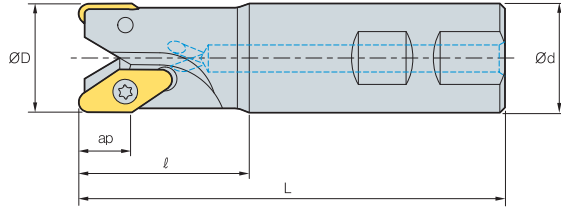
Designation	Ød	NC arbors	Designation	Ød	NC arbors
PAC 2040HR	16	BT□□-FMC16-□□	PAC 4040HR	16	BT□□-FMC16-□□
(PACM) 2050HR	22	BT□□-FMC22-□□	(PACM) 4050HR	22	BT□□-FMC22-□□
2063HR	22	BT□□-FMC22-□□	4063HR	22	BT□□-FMC22-□□
2080HR	25.4	BT□□-FMC25.4-□□	4080HR	25.4	BT□□-FMC25.4-□□
	27	BT□□-FMC27-□□		27	BT□□-FMC27-□□
2100HR	31.75	BT□□-FMC31.75-□□	4100HR	31.75	BT□□-FMC31.75-□□
	32	BT□□-FMC32-□□		32	BT□□-FMC32-□□

Parts

Specification			Arbor Bolt
Ø40~Ø100 (2000 type)	ETNA02506	TW07S	
Ø40~Ø100 (4000 type)	FTNC04509(Ø40)	TW20S	PHMA0834(Ø40)
	FTNC04511		

Available inserts E29 Available arbors and bolt E426~E428

PAS2000/4000



AA
90°
• AR: 0°~7°
• RR: -21°~3°

(mm)

Designation	Inserts	ØD	Ød	l	L	ap	kg
PAS	2012HR	1	12	16	25	85	0.1
	2016HR	2	16	16	25	90	0.11
	* 2016HR-R2.0	2	16	16	25	90	0.11
	2020HR	2	20	20	30	100	0.2
	* 2020HR-R2.0	2	20	20	30	100	0.2
	2025HR	3	25	25	35	115	0.36
	2032HR	4	32	32	40	125	0.66
	2042HR	5	42	32	42	130	0.84
PAS	4032HR	2	32	32	50	125	0.6
	4040HR	3	40	32	50	140	0.8
	4040HR-S40	3	40	40	60	150	1.2
	4040HR-S42	3	40	42	60	150	1.2

Holders marked with an asterisk (*) are only for VDKT11T220N-MA.

Available inserts

VDKT-MA VCKT-MA



Type	Designation	Cermet		Coated										Uncoated			page			
		CN2500	CN30	NC5330	NCM325	NCM335	NCM535	NCM545	PC2505	PC2510	PC3700	PC6510	PC9530	PC9540	PC5300	PC5400		ST30A	G10	H01
2000 type	VDKT	11T210N-MA																		●
		11T220N-MA																		
4000 type	VCKT	220530N-MA																		●

Parts

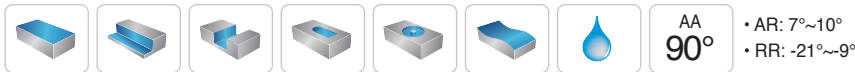
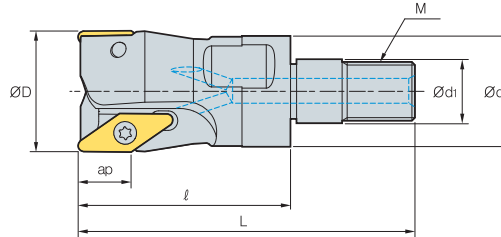
Specification	Screw	Wrench
Ø12~Ø42 (2000 type)	ETNA02505* ETNA02506	TW07S
Ø32~Ø40 (4000 type)	FTNC04509	TW20S

* For PAS2012-2016

Available inserts E29



PAM2000



Designation		⌚	ØD	Ød	Ød1	ℓ	L	M	ap	kg
PAM	2012HR-M06	1	12	11.0	6.5	33	48	M06	8	0.02
	2016HR-M08	2	16	14.5	8.5	36	53	M08	8	0.04
	2020HR-M10	2	20	18.0	10.5	36	57	M10	8	0.06
	2025HR-M12	3	25	22.5	12.5	41	65	M12	8	0.1
	2032HR-M16	4	32	28.5	17.0	45	72	M16	8	0.18
	2042HR-M16	5	42	28.5	17.0	45	72	M16	8	0.27

(mm)

Available inserts

VDKT-MA



Designation	Cermet		Coated										Uncoated			page			
	CN2500	CN30	NC5330	NCM325	NCM335	NCM635	NCM545	PC2505	PC2510	PC3700	PC6510	PC9530	PC9540	PC5300	PC5400		ST30A	G10	H01
VDKT 11T210N-MA																		●	E29

Available adaptors

Designation	Available adaptors
PAM 2012HR-M06	MAT-M06
2016HR-M08	MAT-M08
2020HR-M10	MAT-M10
2025HR-M12	MAT-M12
2032HR-M16	MAT-M16
2042HR-M16	MAT-M16

Designation: PAM2012HR-M06
Modular head threading measure size (M06)

||

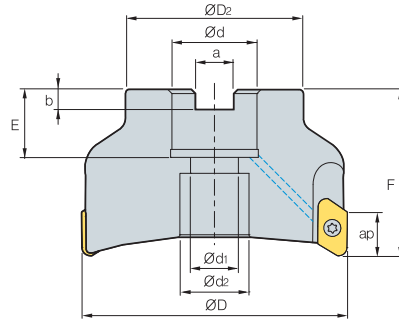
Adaptor spec.: MAT-M06-030-S20S
Adaptor threading measure (M06)

Parts

Specification	Screw	Wrench
Ø12~Ø42	ETNA02505* ETNA02506	TW07S

Available inserts E29 Available adaptors E401~E402 * For PAS2012-2016

PAXC(M)5000



AA
90°

• AR: 8°~17.5°
• RR: -9.5°~5°

(mm)

Designation		⊕	ØD	ØD ₂	Ød	Ød ₁	Ød ₂	a	b	E	F	Max rpm	ap	
PAXCM	5040HR-A,B	3	40	34	16	9	14	8.4	5.6	19	40	25,800	17	0.15
	5050HR-A,B	4	50	42	22	11	18	10.4	6.3	21	50	23,000	17	0.3
	5063HR-A,B	5 (4)	63	49	22	11	18	10.4	6.3	21	50	20,500	17	0.56
PAXC (PAXCM)	5080HR-A,B	5	80	57	25.4 (27)	14	20	9.5 (12.4)	6 (7)	24 (23)	50	18,200	17	1.0
	5100HR-A,B	6	100	67	31.75 (32)	18	26	12.7 (14.4)	8 (8)	32 (26)	63	16,300	17	2.3
	5125HR-A,B	7	125	87	38.1 (40)	22	32	15.9 (16.4)	10 (9)	35 (29)	63	14,600	17	3.2

• A type: Insert NoseR 0.4~3.2, B type: Insert NoseR 4.0~5.0

() Metric size

Available inserts

XEKT-MA XEKT-ML



Designation	Cement	Coated									Uncoated			page	Designation	Cement	Coated									Uncoated			page																	
		CN2500 CN30	NC5330	NCM535	NCM645	PC2505	PC2510	PC3700	PC6510	PC9530	PC9940	PC5300	PC5400				PD2000	PD1010	ST30A	G10	H01	H05	CN2500 CN30	NC5330	NCM535	NCM645	PC2505	PC2510		PC3700	PC6510	PC9530	PC9940	PC5300	PC5400	PD2000	PD1010	ST30A	G10	H01	H05					
XEKT	19M504FR-MA																	●●	●●					E31	XEKT	19M504ER-ML																				E31
	19M508FR-MA																	●●	●●						19M508ER-ML																					
	19M512FR-MA																	●●	●●						19M512ER-ML																					
	19M516FR-MA																	●	●●						19M516ER-ML																					
	19M518FR-MA																								19M518ER-ML																					
	19M520FR-MA																		●●	●●					19M520ER-ML																					
	19M530FR-MA																		●	●●					19M530ER-ML																					
	19M532FR-MA																		●●	●●					19M532ER-ML																					
	19M540FR-MA																		●●	●●					19M540ER-ML																					
	19M550FR-MA																		●●	●●					19M550ER-ML																					

Available arbors

Designation	Ød	Available arbors
PAXCM	5040HR-A,B	BT□□-FMC16-□□
	5050HR-A,B	BT□□-FMC22-□□
	5063HR-A,B	
PAXC (PAXCM)	5080HR-A,B	BT□□-FMA25.4-□□
	5100HR-A,B	BT□□-FMC27-□□
		BT□□-FMA31.75-□□
	5125HR-A,B	BT□□-FMC32-□□
		BT□□-FMA38.1-□□
	40	BT□□-FMC40-□□

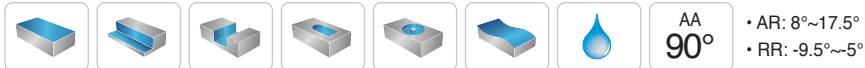
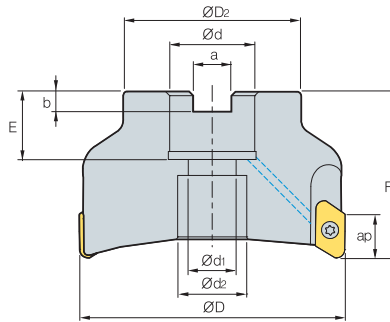
Parts

Specification	Screw	Wrench
Ø40~Ø125	PTKA0408	TW15S

Available inserts E31 Available arbors and bolt E426~E428



PAXC(M)6000



(mm)

Designation		ØD	ØD2	Ød	Ød1	Ød2	a	b	E	F	Max rpm	ap		
PAXCM	6050HR-A,B	2	50	42	16	9	14	8.4	5.6	18	50	23,000	23	0.32
	6063HR-A,B	3	63	49	22	11	18	10.4	6.3	21	50	20,500	23	0.53
PAXC (PAXCM)	6080HR-A,B	4	80	57	25.4 (27)	14	20	9.5 (12.4)	6 (7)	25 (23)	50	18,200	23	0.73
	6100HR-A,B	5	100	67	31.75 (32)	18	26	12.7 (14.4)	8 (8)	32.5 (26)	63	16,300	23	1.7
	6125HR-A,B	6	125	87	38.1 (40)	22	32	15.9 (16.4)	10 (9)	35 (29)	63	14,600	23	3.06

• A type: Insert NoseR 0.4~3.2, B type: Insert NoseR 4.0~5.0

()Metric size

Available inserts

XEKT-MA XEKT-ML



Designation	Cement								page	Designation	Cement								page																			
	CN2500 CN30	NC5330 NCM325	NCM335	NCM535	NCM545	PC2505	PC2510	PC3700			PC6510	PC9530	PC9540	PC5300	PC5400	ST30A	G10	H01		H05	Designation	CN2500 CN30	NC5330 NCM325	NCM335	NCM535	NCM545	PC2505	PC2510	PC3700	PC6510	PC9530	PC9540	PC5300	PC5400	ST30A	G10	H01	H05
XEKT 250604FR-MA										E31	XEKT 250604ER-ML																								E31			
250608FR-MA											250608ER-ML																											
250612FR-MA											250612ER-ML																											
250616FR-MA											250616ER-ML																											
250620FR-MA											250620ER-ML																											
250630FR-MA											250630ER-ML																											
250632FR-MA											250632ER-ML																											
250640FR-MA											250640ER-ML																											
250650FR-MA											250650ER-ML																											

Available arbors

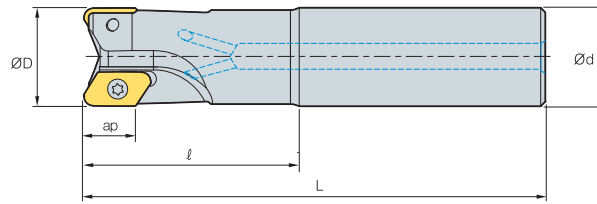
Designation	Ød	Available arbors
PAXCM 6050HR-A,B	16	BT□□-FMC16-□□
6063HR-A,B	22	BT□□-FMC22-□□
PAXC (PAXCM) 6080HR-A,B	25.4	BT□□-FMA25.4-□□
	27	BT□□-FMC27-□□
	31.75	BT□□-FMA31.75-□□
6100HR-A,B	32	BT□□-FMC32-□□
	38.1	BT□□-FMA38.1-□□
6125HR-A,B	40	BT□□-FMC40-□□

Parts

Specification		
Ø50~Ø125	FTGA0513-P	TW20-100

Available inserts E31 Available arbors and bolt E426~E428

PAXS5000



AA
90°

• AR: 5°~10°
• RR: -14°~5°

(mm)

Designation	Flutes	ØD	Ød	ℓ	L	Max rpm	ap	kg
PAXS 5020HR-A,B	1	20	20	60	130	15,000	17	0.24
5025HR-A,B	2	25	25	60	140	32,600	17	0.4
5025HR-A,B-L200	2	25	25	60	200	32,600	17	0.63
5032HR-A,B	2	32	32	70	150	28,800	17	0.74
5032HR-A,B-L220	2	32	32	70	220	28,800	17	1.2
5040HR-A,B-S32	3	40	32	70	160	25,800	17	1.0
5040HR-A,B-L220	3	40	32	70	220	25,800	17	1.4
5040HR-A,B-S40	3	40	40	70	160	25,800	17	1.3
5040HR-A,B-S42	3	40	42	70	160	25,800	17	1.4

• A type: Insert NoseR 0.4~3.2, B type: Insert NoseR 4.0~5.0

Available inserts

XEKT-MA

XEKT-ML



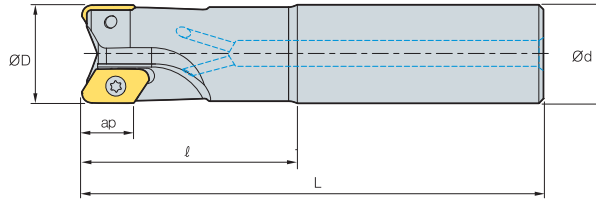
Designation	Coated								Uncoated			page	Designation	Coated								Uncoated			page																																																	
	CN2500	CN30	NC5330	NCM535	NCM545	PC2505	PC2510	PC3700	PC6510	PC9530	PC9540			PC5400	PD2000	PD1010	ST30A	G10	H01	H05	CN2500	CN30	NC5330	NCM535		NCM545	PC2505	PC2510	PC3700	PC6510	PC9530	PC9540	PC5400	PD2000	PD1010	ST30A	G10	H01	H05																																			
XEKT 19M504FR-MA										●	●		●	●																							page	XEKT 19M504ER-ML																																				page
19M508FR-MA											●	●		●	●																							19M508ER-ML																																				
19M512FR-MA											●	●		●	●																							19M512ER-ML																																				
19M516FR-MA												●	●		●	●																						19M516ER-ML																																				
19M518FR-MA												●	●		●	●																						19M518ER-ML																																				
19M520FR-MA											●	●		●	●																						E31	19M520ER-ML																																		E31		
19M530FR-MA												●	●		●	●																						19M530ER-ML																																				
19M532FR-MA												●	●		●	●																						19M532ER-ML																																				
19M540FR-MA												●	●		●	●																						19M540ER-ML																																				
19M550FR-MA												●	●		●	●																						19M550ER-ML																																				

Parts

Specification	Screw	Wrench
Ø20	PTKA0407	TW15S
Ø25~Ø40	PTKA0408	



PAXS6000



Designation		ØD	Ød	l	L	Max rpm	ap	
PAXS 6025HR-A,B	1	25	25	60	140	32,600	23	0.42
6025HR-A,B-L200	1	25	25	60	200	32,600	23	0.63
6032HR-A,B	1	32	32	70	150	28,800	23	0.72
6032HR-A,B-L220	1	32	32	70	220	28,800	23	1.14
6040HR-A,B-S32	2	40	32	70	160	25,800	23	0.88
6040HR-A,B-L220	2	40	32	70	220	25,800	23	1.23
6040HR-A,B-S40	2	40	40	70	160	25,800	23	1.2
6040HR-A,B-S42	2	40	42	70	160	25,800	23	1.3

• A type: Insert NoseR 0.4~3.2, B type: Insert NoseR 4.0~5.0

Available inserts

XEKT-MA XEKT-ML



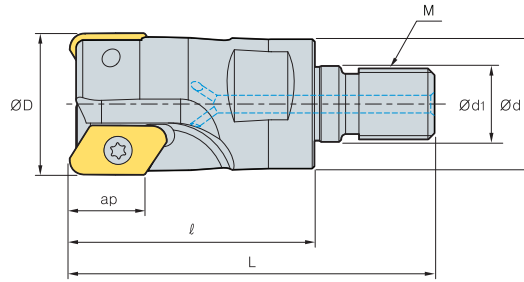
Designation	Coated										Uncoated			page	Designation	Coated										Uncoated			page										
	CN2500	CN30	NC5330	NCM325	NCM335	NCM535	NCM545	PC2505	PC2510	PC3700	PC6510	PC9530	PC9540			PC5300	PC5400	ST30A	G10	H01	H05	CN2500	CN30	NC5330	NCM325	NCM335	NCM535	NCM545		PC2505	PC2510	PC3700	PC6510	PC9530	PC9540	PC5300	PC5400	ST30A	G10
XEKT 250604FR-MA																		●●	XEKT 250604ER-ML																				
250608FR-MA																		●●	250608ER-ML																				
250612FR-MA																		●●	250612ER-ML																				
250616FR-MA																		●●	250616ER-ML																				
250620FR-MA																		●●	250620ER-ML																				
250630FR-MA																		●●	250630ER-ML																				
250632FR-MA																		●●	250632ER-ML																				
250640FR-MA																		●●	250640ER-ML																				
250650FR-MA																		●●	250650ER-ML																				

Parts

Specification		
Ø25~Ø32	FTGA0510-P	TW20-100
Ø40	FTGA0513-P	

Available inserts E31

PAXM5000



AA
90°
• AR: 6°~8°
• RR: -7°~5°

(mm)

Designation		ØD	Ød	Ød1	l	L	M	ap	
PAXM	5025HR-A,B-M12	2	25	23	12.5	55	79	M12	0.12
	5032HR-A,B-M16	2	32	29	17.0	55	82	M16	0.2
	5040HR-A,B-M16	3	40	29	17.0	55	82	M16	0.4

• A type: Insert NoseR 0.4~3.2, B type: Insert NoseR 4.0~5.0

Available inserts

XEKT-MA XEKT-ML



Designation	Cement										page	Designation	Cement										page																		
	Coated					Uncoated							Coated					Uncoated																							
	CN2500	CN30	NC5330	NCM635	NCM645	PC2505	PC2510	PC3700	PC6510	PC9530	PC9540	PC5300	PC5400	PD2000	PD1010	ST30A	G10	H01	H05		CN2500	CN30	NC5330	NCM635	NCM645	PC2505	PC2510	PC3700	PC6510	PC9530	PC9540	PC5300	PC5400	PD2000	PD1010	ST30A	G10	H01	H05		
XEKT 19M504FR-MA											●	●								E31	XEKT 19M504ER-ML																				E31
19M508FR-MA											●	●									19M508ER-ML																				
19M512FR-MA											●	●									19M512ER-ML																				
19M516FR-MA											●	●									19M516ER-ML																				
19M518FR-MA																					19M518ER-ML																				
19M520FR-MA											●	●									19M520ER-ML																				
19M530FR-MA											●	●									19M530ER-ML																				
19M532FR-MA											●	●									19M532ER-ML																				
19M540FR-MA											●	●									19M540ER-ML																				
19M550FR-MA											●	●									19M550ER-ML																				

Available adaptor

Designation	Available adaptor
PAXM 5025HR-A,B-M12	MAT-M12
5032HR-A,B-M16	MAT-M16
5040HR-A,B-M16	

Designation: PAXM5025HR-M12
Modular head threading measure size (M12)

II

Adaptor spec.: MAT-M12-030-S25S
Adaptor threading measure (M12)

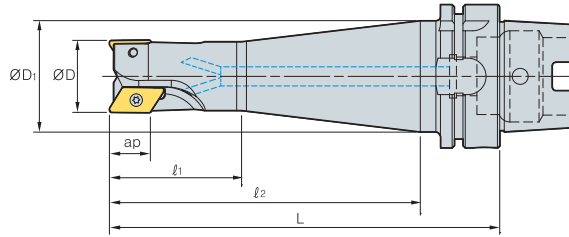
Parts

Specification		
Ø25~Ø40	PTKA0408	TW15S

Available inserts E31 Available adaptors E401~E402



HSK63A/100A PAX5000



Designation		ØD	ØD1	l1	l2	L	ap	
HSK63A PAX5032HR-A, B	2	32	53	58	137	163	17	1.14
HSK100A PAXCM5080HR-A, B	5	80	-	-	66	95	17	4
PAXCM5100HR-A, B	6	100	-	-	66	95	17	4.6

• A type: Insert NoseR 0.4~3.2, B type: Insert NoseR 4.0~5.0
 • For the maximum rake angle and the rpm limit, please refer to technical information on pp. E377~E378.

Available inserts

XEKT-MA XEKT-ML



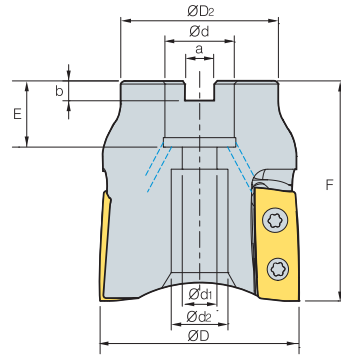
Designation	Material										page	Designation	Material										page															
	Cermet	Coated					Uncoated						Cermet	Coated					Uncoated																			
	CN2500	CN30	NC5330	NCM535	NCM545	PC2505	PC3700	PC6510	PC9530	PC9540	PC5300	PC5400	PD2000	PD1010	ST30A	G10	H01	H05		CN2500	CN30	NC5330	NCM535	NCM545	PC2505	PC3700	PC6510	PC9530	PC9540	PC5300	PC5400	PD2000	PD1010	ST30A	G10	H01	H05	
XEKT 19M504FR-MA														●					XEKT 19M504ER-ML																			
19M508FR-MA														●					19M508ER-ML																			
19M512FR-MA														●					19M512ER-ML																			
19M516FR-MA														●					19M516ER-ML																			
19M518FR-MA																			19M518ER-ML																			
19M520FR-MA														●					19M520ER-ML																			
19M530FR-MA														●					19M530ER-ML																			
19M532FR-MA														●					19M532ER-ML																			
19M540FR-MA														●					19M540ER-ML																			
19M550FR-MA														●					19M550ER-ML																			

Parts

Specification		
Ø32~Ø100	PTKA0407 PTKA0408	TW15S

Available inserts E31

PALCM



(mm)

Designation		ØD	ØD ₂	Ød	Ød ₁	Ød ₂	a	b	E	F	ap	
PALCM 063HR	4	63	50	22	11	21	10	6.3	20	70	34	0.57

Available inserts

LXET-MA LXET-ML



Designation	Cermet		Coated										Uncoated			page			
	CN2500	CN30	NC5330	NCM325	NCM335	NCM535	NCM545	PC2505	PC2510	PC3700	PC6510	PC9530	PC9540	PC5300	PC5400		ST30A	G10	H01
LXET 340504PEFR-63-MA																			E13
3405PEFR-63-MA																		●	
340512PEFR-63-MA																			
340516PEFR-63-MA																			
340504PEER-63-ML																			
3405PEER-63-ML																			
340512PEER-63-ML																			
340516PEER-63-ML																			

Available arbors

Designation	Ød	Available arbors
PALCM 063HR	22	BT□□-FMC22-□□

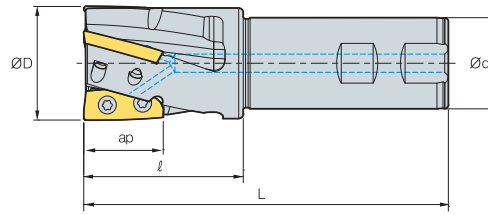
Parts

Specification		
Ø63	FTGA0511-P	TW20-100

Available inserts E13 Available arbors and bolt E426~E428



PALS (Single-edge)



Designation		ØD	Ød	l	L	ap	
PALS 032HR-2S20	2	32	20	50	140	25	0.36
032HR-2S25	2	32	25	50	140	25	0.48
032HR-2S32	2	32	32	50	140	25	0.71
040HR-2S32	2	40	32	50	140	25	0.85
040HR-2S40	2	40	40	50	140	25	1.16
040HR-2S42	2	40	42	50	140	25	1.26
040HR-3S32	3	40	32	50	140	25	0.80
040HR-3S40	3	40	40	50	140	25	1.10
040HR-3S42	3	40	42	50	140	25	1.20

Available inserts

LXET-MA LXET-ML



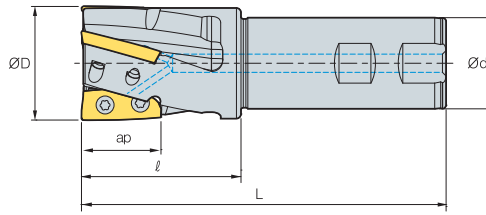
Type	Designation	Cermet		Coated												Uncoated			page		
		CN2500	CN30	NC5330	NCM325	NCM335	NCM535	NCM545	PC2505	PC2510	PC3700	PC6510	PC9530	PC9540	PC5300	PC5400	ST30A	Gi10		H01	
Ø32	LXET	250404PEFR-32-MA																			
		2504PEFR-32-MA																			●
		250412PEFR-32-MA																			
		250416PEFR-32-MA																			
		250404PEER-32-ML																			
		2504PEER-32-ML																			
		250412PEER-32-ML																			
		250416PEER-32-ML																			
Ø40	LXET	250404PEFR-40-MA																			
		2504PEFR-40-MA																			
		250412PEFR-40-MA																			
		250416PEFR-40-MA																			
		250404PEER-40-ML																			
		2504PEER-40-ML																			
		250412PEER-40-ML																			
		250416PEER-40-ML																			

Parts

Specification		
Ø32	FTKA0408	TW15S
Ø40	FTKA0410	TW15S

Available inserts E13

PALS (Single-edge)



AA
90°
• AR: 12°~16°
• RR: -5°~9°

(mm)

Designation		ØD	Ød	l	L	ap	
PALS 050HR-3S32	3	50	32	70	160	34	1.10
050HR-3S40	3	50	40	70	160	34	1.40
050HR-3S42	3	50	42	70	160	34	1.50
063HR-4S32	4	63	32	70	160	34	1.60
063HR-4S40	4	63	40	70	160	34	1.92
063HR-4S42	4	63	42	70	160	34	2.00

Available inserts

LXET-MA LXET-ML



Type	Designation	Cermet		Coated											Uncoated			page				
		CN2500	CN30	NC5330	NCM325	NCM335	NCM535	NCM545	PC2505	PC2510	PC3700	PC6510	PC9530	PC9540	PC5300	PC5400	ST30A		G10	H01		
Ø50	LXET 340504PEFR-50-MA																			●		
	3405PEFR-50-MA																				●	
	340512PEFR-50-MA																					
	340516PEFR-50-MA																					
	340504PEER-50-ML																					
	3405PEER-50-ML																					●
	340512PEER-50-ML																					
Ø63	LXET 340504PEFR-63-MA																					
	3405PEFR-63-MA																					●
	340512PEFR-63-MA																					
	340516PEFR-63-MA																					
	340504PEER-63-ML																					
	3405PEER-63-ML																					
	340512PEER-63-ML																					

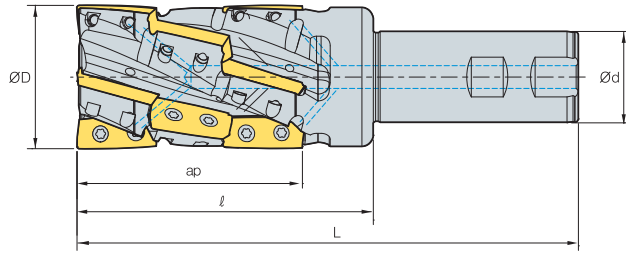
Parts

Specification		
Ø50	FTGA0510-P	TW20-100
Ø63	FTGA0511-P	TW20-100

Available inserts E13



PALS (Multi-edge)



Designation			Ød	Ød ₁	l	L	ap	
PALS	063HM-4S32	12	63	32	130	220	96	1.60
	063HM-4S40	12	63	40	130	220	96	1.92
	063HM-4S42	12	63	42	130	220	96	2.00

Available inserts

LXET-MA LXET-ML



Designation	Cermet		Coated											Uncoated			page	
	CN2500	CN30	NC5330	NCM325	NCM335	NCM635	NCM645	PC2505	PC2510	PC3700	PC6510	PC9530	PC9540	PC5300	PC5400	ST30A		G10
LXET 340504PEFR-63-MA																		
3405PEFR-63-MA																		●
340512PEFR-63-MA																		
340516PEFR-63-MA																		
340504PEER-63-ML																		
3405PEER-63-ML																		
340512PEER-63-ML																		
340516PEER-63-ML																		

Parts

Specification		
Ø63	FTGA0511-P	TW20-100

Available inserts E13

PXL new

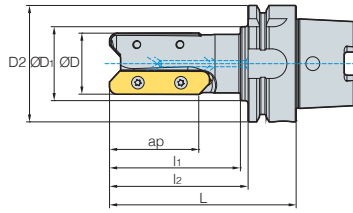


Fig. 1

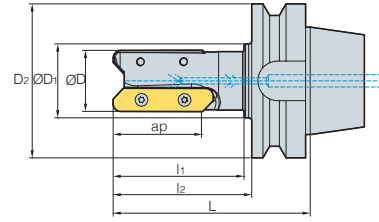


Fig. 2



(mm)

Designation		ØD	ØD ₁	ØD ₂	l ₁	l ₂	L	ap		Fig.
HSK63A PXL04090HR-2F	2	40	48	63	85	90	116	57	1.13	1
HSK100A PXL04090HR-3F	3	40	70	100	90	100	129	57	2.74	1
	5	80	77	100	-	90	119	57	4.29	1
BT50 PXL04090HR-2F	2	40	48	100	85	90	128	57	4.13	2

Available inserts

LDET-MA



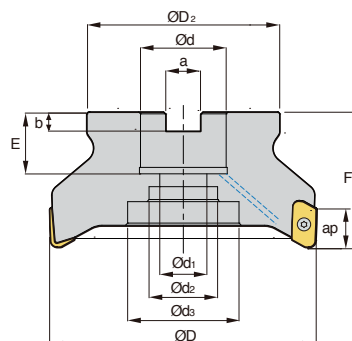
Designation	Cermet		Coated										Uncoated			page			
	CN2500	CN30	NC5330	NCM325	NCM335	NCM535	NCM545	PC2505	PC2510	PC3700	PC6510	PC9530	PC9540	PC5300	PC5400		ST30A	G10	H01
LDET 650540PPFR-MA																			E10
650550PPFR-MA																			

Parts

Specification		
Ø40~80	FTGA0511-P	TW20-100

Available inserts E10



PAVCM-XD19 **new**

AA
90°

• AR: 11°~14°
• RR: -11°~-9°

(mm)

Designation		ØD	ØD ₂	Ød	Ød ₁	Ød ₂	Ød ₃	a	b	E	F	ap		
PAVCM	040R-16-3-XD19-A,B	3	40	34	16	9	13.5	-	8.4	5.6	16	45	17	0.17
	050R-22-4-XD19-A,B	4	50	42	22	11	18	-	10.4	6.3	21	50	17	0.35
	063R-22-5-XD19-A,B	5	63	42	22	11	18	-	10.4	6.3	21	50	17	0.53
	080R-27-5-XD19-A,B	5	80	60	27	14	20	-	12.4	7.0	24	50	17	0.88
	100R-32-6-XD19-A,B	6	100	70	32	18	26	42	14.4	8.0	25	63	17	1.72
	125R-40-7-XD19-A,B	7	125	90	40	22	32	52	16.4	9.0	29	63	17	2.82

• Type A uses Insert Nose R 0.4~3.2, and Type B uses Nose R 4.0~5.0

• When using a spindle at high speed, please check the balance of tool and use it after replacing with the new screw.

Available inserts

XDET-MA



Designation	Cermet		Coated							Uncoated	page	Designation	Cermet		Coated							Uncoated	page																	
	CN2500	CN30	NC5330	NCM325	NCM335	NCM535	NCM545	PC3700	PC6510				PC9530	PC9940	PC5300	PC5400	PD1005	PD1010	H01	H05	CN2500			CN30	NC5330	NCM325	NCM335	NCM535	NCM545	PC3700	PC6510	PC9530	PC9940	PC5300	PC5400	PD1005	PD1010	H01	H05	
XDET 190504PEFR-MA																																								
190508PEFR-MA																																								
190512PEFR-MA																																								
190516PEFR-MA																																								
190520PEFR-MA																																								

Available arbors

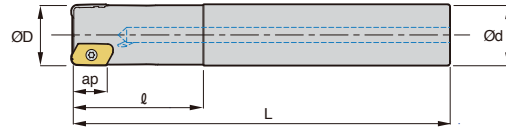
Designation	Available arbors
PAVCM 040R-16-3-XD19	BT□□-FMC16-□□
050R-22-4-XD19	BT□□-FMC22-□□
063R-22-5-XD19	BT□□-FMC22-□□
080R-27-5-XD19	BT□□-FMC27-□□
100R-32-6-XD19	BT□□-FMC32-□□
125R-40-7-XD19	BT□□-FMC40-□□

Parts

Specification		
Ø40~Ø125	PTKA0408-A	TW15S

Available inserts E31 Available arbors and bolt E426~E428

PAVS-XD19 new



• AR: 8°~11°
• RR: -14°~11°

(mm)

Designation		Flutes	ØD	Ød	ℓ	L	ap	Weight (kg)
PAVS	025R-2C25-140-XD19-A,B	2	25	25	60	140	17	0.40
	032R-2C32-150-XD19-A,B	2	32	32	70	150	17	0.76
	032R-2C32-200-XD19-A,B	2	32	32	70	200	17	1.06
	040R-3C40-200-XD19-A,B	3	40	40	70	200	17	1.71

- Type A uses Insert Nose R 0.4~3.2, and Type B uses Nose R 4.0~5.0
- When using a spindle at high speed, please check the balance of tool and use it after replacing with the new screw.

Available inserts

XDET-MA



Designation	Cermet	Coated									page	Designation	Cermet	Coated									page										
	CN2500 CN30	NC5330	NCM325	NCM335	NCM635	NCM645	PC3700	PC6610	PC9530	PC9540			PC5300	PC5400	PD1005	PD1010	H01	H05	CN2500 CN30	NC5330	NCM325	NCM335		NCM635	NCM645	PC3700	PC6610	PC9530	PC9540	PC5300	PC5400	PD1005	PD1010
XDET 190504PEFR-MA												••		XDET 190524PEFR-MA																		••	
XDET 190508PEFR-MA												••		XDET 190530PEFR-MA																		••	
XDET 190512PEFR-MA												••	E31	XDET 190532PEFR-MA																	••	E31	
XDET 190516PEFR-MA												••		XDET 190540PEFR-MA																	••		
XDET 190520PEFR-MA												••		XDET 190550PEFR-MA																	••		

Parts

Specification		
	Screw	Wrench
Ø25~Ø40	PTKA0408-A	TW15S

Available inserts E31



MAT (Steel shank type)

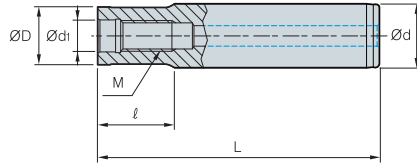


Fig. 1

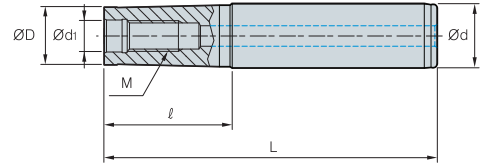


Fig. 2

(mm)

Designation	ØD	Ød	Ød ₁	ℓ	L	M	Fig.
MAT- M06-020-S10S	9.5	10	6.5	20	70	M06	1
M6B-020-S12S	11.0	12	6.5	20	76	M06	1
M6B-040-S12S	11.0	12	6.5	40	96	M06	1
M08-020-S16S	14.5	16	8.5	20	80	M08	1
M10-030-S20S	18.0	20	10.5	30	100	M10	1
M12-030-S25S	22.5	25	12.5	29	110	M12	1
M16-035-S32S	28.5	32	17.0	35	125	M16	1
M06-040-S12T	9.5	12	6.5	40	96	M06	2
M06-065-S16T	9.5	16	6.5	65	125	M06	2
M6B-065-S16T	11.0	16	6.5	65	125	M06	2
M6B-080-S16T	11.0	16	6.5	80	140	M06	2
M08-040-S16T	14.5	16	8.5	40	100	M08	2
M08-065-S16T	14.5	16	8.5	65	125	M08	2
M08-080-S20T	14.5	20	8.5	80	150	M08	2
M08-110-S25T	14.5	25	8.5	110	190	M08	2
M10-050-S20T	18.0	20	10.5	50	120	M10	2
M10-070-S20T	18.0	20	10.5	70	140	M10	2
M10-090-S25T	18.0	25	10.5	90	170	M10	2
M10-110-S25T	18.0	25	10.5	110	190	M10	2
M10-130-S32T	18.0	32	10.5	130	220	M10	2
M12-050-S25T	22.5	25	12.5	50	130	M12	2
M12-070-S25T	22.5	25	12.5	70	150	M12	2
M12-090-S25T	22.5	25	12.5	90	170	M12	2
M12-110-S32T	22.5	32	12.5	110	200	M12	2
M12-175-S40T	22.5	40	12.5	175	300	M12	2
M16-055-S32T	28.5	32	17.0	55	145	M16	2
M16-080-S32T	28.5	32	17.0	80	170	M16	2
M16-120-S32T	28.5	32	17.0	120	210	M16	2
M16-175-S40T	28.5	40	17.0	175	300	M16	2

• S: straight neck adaptor • T: taper neck adaptor

FMRM type  ↻ E238~241, E250~253	LBE-MHD type  ↻ E330	PAM/PAXM type  ↻ E387, 392	AMM type  ↻ E190~192	RM3PM type  ↻ E104	RM4PM/RM4ZM type  ↻ E117, 119
RM6PM type  ↻ E124, 125	HFMDM type  ↻ E275	HFMM type  ↻ E283	HRMM type  ↻ E305, 306	HRMDM type  ↻ E297~299	GBEM type  ↻ E334

↻ Applicable modular E45, E46 (FMRM, LBE, PAM, AMM, RM4PM, HFMM, RM4ZM, HRMM, PAXM)

MAT-C (Carbide shank type)

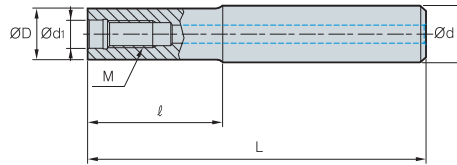


Fig. 1

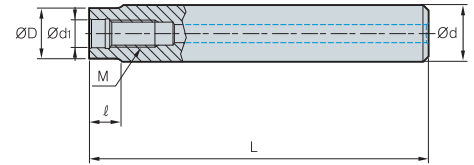


Fig. 2

(mm)

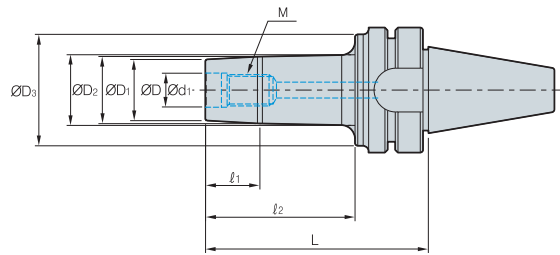
Designation	ØD	Ød	Ød ₁	ℓ	L	M	Fig.
MAT- M06-030-S10S-C-80	9.5	10	6.5	30	80	M06	1
MAT- M06-050-S10S-C-100	9.5	10	6.5	50	100	M06	1
MAT- M06-080-S10S-C-130	9.5	10	6.5	80	130	M06	1
MAT- M6B-030-S12S-C-80	11.0	12	6.5	30	80	M06	1
MAT- M6B-050-S12S-C-100	11.0	12	6.5	50	100	M06	1
MAT- M6B-080-S12S-C-130	11.0	12	6.5	80	130	M06	1
MAT- M08-080-S16S-C	14.5	16	8.5	80	150	M08	1
MAT- M08-110-S16S-C	14.5	16	8.5	110	180	M08	1
MAT- M08-150-S16S-C	14.5	16	8.5	150	250	M08	1
MAT- M08-010-S16S-C-150	14.5	16	8.5	10	150	M08	2
MAT- M08-010-S16S-C-180	14.5	16	8.5	10	180	M08	2
MAT- M08-010-S16S-C-250	14.5	16	8.5	10	250	M08	2
MAT- M10-090-S20S-C	18.0	20	10.5	90	170	M10	1
MAT- M10-110-S20S-C	18.0	20	10.5	110	200	M10	1
MAT- M10-175-S20S-C	18.0	20	10.5	175	300	M10	1
MAT- M10-010-S20S-C-170	18.0	20	10.5	10	170	M10	2
MAT- M10-010-S20S-C-200	18.0	20	10.5	10	200	M10	2
MAT- M10-010-S20S-C-300	18.0	20	10.5	10	300	M10	2
MAT- M12-090-S25S-C	22.5	25	12.5	90	170	M12	1
MAT- M12-110-S25S-C	22.5	25	12.5	110	200	M12	1
MAT- M12-175-S25S-C	22.5	25	12.5	175	300	M12	1
MAT- M12-015-S25S-C-170	22.5	25	12.5	15	170	M12	2
MAT- M12-015-S25S-C-200	22.5	25	12.5	15	200	M12	2
MAT- M12-015-S25S-C-300	22.5	25	12.5	15	300	M12	2
MAT- M16-090-S32S-C	28.5	32	17.0	90	180	M16	1
MAT- M16-120-S32S-C	28.5	32	17.0	120	210	M16	1
MAT- M16-175-S32S-C	28.5	32	17.0	175	300	M16	1
MAT- M16-020-S32S-C-180	28.5	32	17.0	20	180	M16	2
MAT- M16-020-S32S-C-210	28.5	32	17.0	20	210	M16	2
MAT- M16-020-S32S-C-300	28.5	32	17.0	20	300	M16	2



↻ Applicable modular E45, E46 (FMRM, LBE, PAM, AMM, RM4PM, HFMM, RM4ZM, HRMM, PAXM)



BT30/BT40/BT50

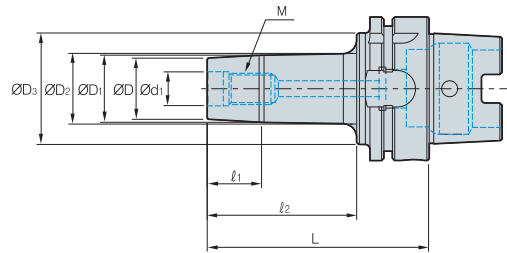


(mm)

Designation	ØD	ØD1	ØD2	ØD3	Ød1	l1	l2	L	M	
BT30-	MAT-M06-053	11.0	11.7	13.0	30	6.5	5	21	53	M06*1.0
	MAT-M08-057	14.5	15.7	17.5	35	8.5	7	25	57	M08*1.25
	MAT-M10-062	18.0	19.7	24.0	38	10.5	7	30	62	M10*1.5
	MAT-M12-067	23.0	24.7	27.5	41	12.5	10	35	67	M12*1.75
	MAT-M16-067	29.0	31.7	33.5	41	17.0	10	35	67	M16*2.0
BT40-	MAT-M06-062	11.0	11.7	14.0	40	6.5	5	25	62	M06*1.0
	MAT-M06-077	11.0	11.7	14.0	40	6.5	5	40	77	M06*1.0
	MAT-M06-092	11.0	11.7	14.0	40	6.5	5	55	92	M06*1.0
	MAT-M08-067	14.5	15.7	19.0	44	8.5	7	30	67	M08*1.25
	MAT-M08-082	14.5	15.7	19.0	44	8.5	7	45	82	M08*1.25
	MAT-M08-097	14.5	15.7	19.0	44	8.5	7	60	97	M08*1.25
	MAT-M10-072	18.0	19.7	23.0	50	10.5	10	35	72	M10*1.5
	MAT-M10-087	18.0	19.7	23.0	50	10.5	10	50	87	M10*1.5
	MAT-M10-102	18.0	19.7	23.0	50	10.5	10	65	102	M10*1.5
	MAT-M12-077	23.0	24.7	30.0	55	12.5	10	40	77	M12*1.75
	MAT-M12-092	23.0	24.7	30.0	55	12.5	13	55	92	M12*1.75
	MAT-M12-107	23.0	24.7	30.0	55	12.5	13	70	107	M12*1.75
	MAT-M16-077	29.0	31.7	37.0	55	17.0	13	40	77	M16*2.0
	MAT-M16-092	29.0	31.7	37.0	55	17.0	13	55	92	M16*2.0
	MAT-M16-107	29.0	31.7	37.0	55	17.0	13	70	107	M16*2.0
BT50-	MAT-M06-083	11.0	11.7	15.0	40	6.5	5	35	83	M06*1.0
	MAT-M06-098	11.0	11.7	15.0	40	6.5	5	50	98	M06*1.0
	MAT-M06-113	11.0	11.7	15.0	40	6.5	5	65	113	M06*1.0
	MAT-M08-088	14.5	15.7	20.0	45	8.5	7	40	88	M08*1.25
	MAT-M08-103	14.5	15.7	20.0	45	8.5	7	55	103	M08*1.25
	MAT-M08-118	14.5	15.7	20.0	45	8.5	7	70	118	M08*1.25
	MAT-M10-093	18.0	19.7	25.0	55	10.5	10	45	93	M10*1.5
	MAT-M10-113	18.0	19.7	25.0	55	10.5	10	65	113	M10*1.5
	MAT-M10-128	18.0	19.7	25.0	55	10.5	10	80	128	M10*1.5
	MAT-M12-103	23.0	24.7	33.0	65	12.5	10	55	103	M12*1.75
	MAT-M12-118	23.0	24.7	33.0	65	12.5	13	70	118	M12*1.75
	MAT-M12-133	23.0	24.7	33.0	65	12.5	13	85	133	M12*1.75
	MAT-M16-103	29.0	31.7	41.0	85	17.0	13	55	103	M16*2.0
	MAT-M16-118	29.0	31.7	41.0	85	17.0	13	70	118	M16*2.0
	MAT-M16-133	29.0	31.7	41.0	85	17.0	13	85	133	M16*2.0

↻ Applicable modular E45, E46

HSK63A/HSK100A



(mm)

Designation	ØD	ØD1	ØD2	ØD3	Ød1	l1	l2	L	M	
HSK63A-	MAT-M06-061	11.0	11.7	27.0	40	6.5	5	25	61	M06*1.0
	MAT-M06-076	11.0	11.7	27.0	40	6.5	5	40	76	M06*1.0
	MAT-M06-091	11.0	11.7	27.0	40	6.5	5	55	91	M06*1.0
	MAT-M08-066	14.5	15.7	30.5	44	8.5	7	30	66	M08*1.25
	MAT-M08-081	14.5	15.7	30.5	44	8.5	7	45	81	M08*1.25
	MAT-M08-096	14.5	15.7	30.5	44	8.5	7	60	96	M08*1.25
	MAT-M10-071	18.0	19.7	34.0	50	10.5	10	35	71	M10*1.5
	MAT-M10-086	18.0	19.7	34.0	50	10.5	10	50	86	M10*1.5
	MAT-M10-101	18.0	19.7	34.0	50	10.5	10	65	101	M10*1.5
	MAT-M12-076	23.0	24.7	36.5	55	12.5	10	40	76	M12*1.75
	MAT-M12-091	23.0	24.7	36.5	55	12.5	13	55	91	M12*1.75
	MAT-M12-106	23.0	24.7	36.5	55	12.5	13	70	106	M12*1.75
	MAT-M16-076	29.0	31.7	38.5	55	17.0	13	40	76	M16*2.0
MAT-M16-091	29.0	31.7	38.5	55	17.0	13	55	91	M16*2.0	
MAT-M16-106	29.0	31.7	38.5	55	17.0	13	70	106	M16*2.0	
HSK100A-	MAT-M06-074	11.0	11.7	15.0	40	6.5	5	35	74	M06*1.0
	MAT-M06-089	11.0	11.7	15.0	40	6.5	5	50	89	M06*1.0
	MAT-M06-104	11.0	11.7	15.0	40	6.5	5	65	104	M06*1.0
	MAT-M08-079	14.5	15.7	20.0	45	8.5	7	40	79	M08*1.25
	MAT-M08-094	14.5	15.7	20.0	45	8.5	7	55	94	M08*1.25
	MAT-M08-109	14.5	15.7	20.0	45	8.5	7	70	109	M08*1.25
	MAT-M10-084	18.0	19.7	25.0	55	10.5	10	45	84	M10*1.5
	MAT-M10-104	18.0	19.7	25.0	55	10.5	10	65	104	M10*1.5
	MAT-M10-119	18.0	19.7	25.0	55	10.5	10	80	119	M10*1.5
	MAT-M12-094	23.0	24.7	33.0	65	12.5	10	55	94	M12*1.75
	MAT-M12-109	23.0	24.7	33.0	65	12.5	13	70	109	M12*1.75
	MAT-M12-124	23.0	24.7	33.0	65	12.5	13	85	124	M12*1.75
	MAT-M16-094	29.0	31.7	41.0	85	17.0	13	55	94	M16*2.0
	MAT-M16-109	29.0	31.7	41.0	85	17.0	13	70	109	M16*2.0
	MAT-M16-124	29.0	31.7	41.0	85	17.0	13	85	124	M16*2.0

↻ Applicable modular E45, E46



Adjusting side cutter

Code system

P: Plane type
B: Boss type

A: Adjusting side cutter
Adjusting

Cutter type

Max. width of cutter
For half side cutter, minimum width of the cutter will be written only

R A FC B 125 14 18 - R

Insert clamping way **Insert configuration** **Cutter Dia.** **Min. width of cutter** **Hand**

R: Radial type
(Using SDXT)

T: Tangential type
(Using CNHQ)

FC
Full side cutter

HC
Half side cutter

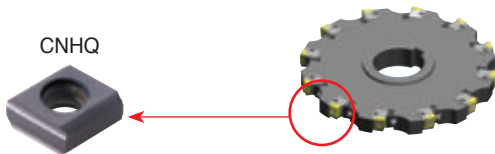
125

14

18

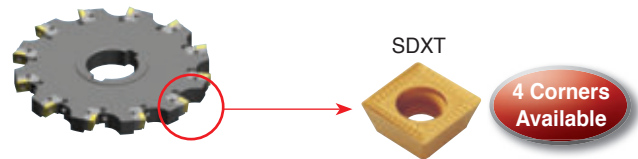
Hand		
Unmarked	R	L
Neutral	Right	Left
Full side cutter (Plane type)	Half side cutter (Boss type)	

Tangential type (High rigidity)



- Medium/Roughing
- Excellent performance at medium to roughing range (14~30 mm) table operation due to the strong rigidity of the cutter
- Good performance in heavy interruption and deep depth of cut application

Radial type (Low cutting load)

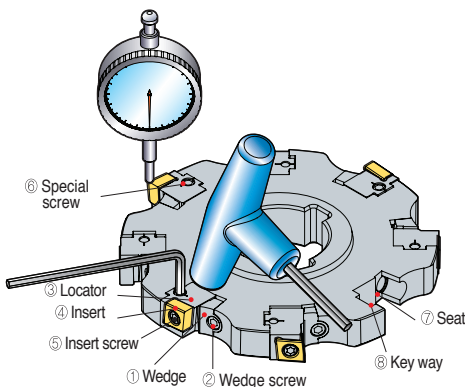


- Medium/Finishing
- Suitable for small width cutting operation (12~24 mm)
- 3 dimensional chip breaker provides smooth cutting operation
- Several chip breakers as per applications are available (MF, MM, FA)
- Economical insert using 4 cutting-edges per insert

Insert features

- Precise adjustable side cutter can control the width of the cutter by 5 μm unit
- Since the width of the cutter is adjustable up to ±1.5 mm, single cutter can cover various cutting width
- Specially designed clamping system of the locator provides excellent rigidity by using elastic deformation of the locator
- Tangential type clamping system of insert provides enough strength can withstand large width cutting operations
- 3-dimensional chip breaker of insert provides smooth cutting with low cutting load at medium to finishing range

Operating manual



How to assemble the adjusting side cutter

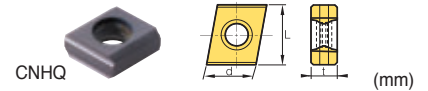
1. Clamp ① wedge slightly on ⑦ locator-wedge pocket by using ② wedge screw
2. Put ③ locator on ⑦ locator-wedge pocket along with the ⑧ key-way
3. Tighten the ⑥ taper screw little bit to set proper position of locator
4. Tighten the ② wedge screw tightly by using 70~80N.m torque
5. After, put the ④ insert on insert pocket of ③ locator, clamp it with ⑤ insert screw by using 40~50N.m torque

How to adjust Run-out & cutting width

1. Settle the adjusting side cutter after cleaning to the jig for measurement
2. Un-screw the ② Wedge screw first, then tighten ① wedge slightly again by using 8N.m torque
3. Adjusting the height of cutting-edge by using a dial gauge to set the width of the cutter
4. Tighten the ② wedge screw tightly by using 70~80N.m torque
5. To finish the setting, tighten the ⑥ taper screw for strong clamp

Tangential type

Cutting width per insert & type of cutter



Designation	Coated		Cutting width for half side cutter (ap)	Cutting width for full side cutter (ap)	L	d	t
	NCM535	PC6510					
CNHQ1005	- C0.5		9.0	14~18	10	10	5.4
	- R0.5						
	- C1.0		8.5	14~17			
	- R1.0						
CNHQ1305	- C0.5		12	18~21/21~24	12.7	10	5.4
	- R0.5						
	- C1.0		11.5	18~21/21~23			
	- R1.0						
	- C1.5		11	18~21/21~22			
	- R1.5						
CNHQ1606	- C0.5		15	24~27/27~30	16	12	6.4
	- R0.5						
	- C1.0		14.5	24~27/27~29			
	- R1.0						
	- C1.5		14	24~27/27~28			
	- R1.5						
	- C2.0		13.5	24~27			
	- R2.0						

Applicable cutter E407, E408 Available arbors and bolt E426~E428

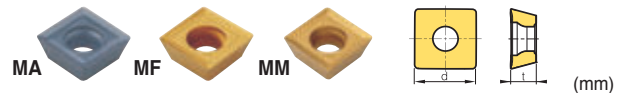
● : Stock item

Recommended cutting condition

ISO	Grades	vc (m/min)	fz (mm/t)
P	NCM535	190~310	0.10~0.30
	PC3700	160~270	
M	PC5300	90~150	0.10~0.30
	NCM335	180~290	
K	PC6510	140~230	0.10~0.30

Radial type

Cutting width per insert & type of cutter



Designation	Coated										Uncoated		Cutting width for half side cutter (ap)	Cutting width for full side cutter (ap)	d	t			
	NC5330	NCM325	NCM335	NCM535	NCM545	PC2505	PC2510	PC3700	PC6510	PC9530	PC9540	PC5300					PC5400	H01	H05
SDXT	09M405R-MA													●	●	8	12~14 14~16	9.525	4
	09M405L-MA																		
	09M405R-MF	●							●	●		●	●						
	09M405L-MF																		
	09M405R-MM	●							●	●		●	●						
	09M405L-MM								●										
SDXT	130508R-MA													●	●	10.5	16~18 18~20 20~22 22~24	13.5	5.56
	130508L-MA																		
	130508R-MF	●							●	●		●	●						
	130508L-MF																		
	130508R-MM	●							●	●		●	●						
	130508L-MM																		

Applicable cutter E409, E410 Available arbors and bolt E426~E428

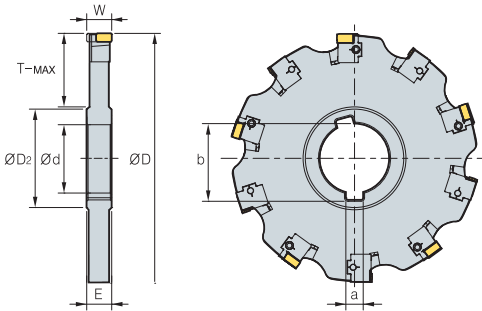
● : Stock item

Recommended cutting condition

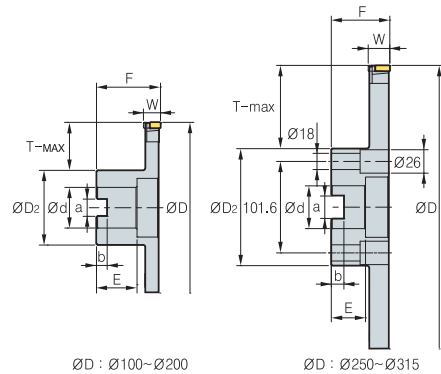
ISO	Grades	vc (m/min)	fz (mm/t)
P	NCM325	190~310	0.08~0.30
	NCM335	180~290	0.08~0.25
	PC3700	160~270	0.10~0.25
M	PC9530	90~150	0.10~0.25
	PC5300	90~150	
K	PC8110	140~230	0.10~0.25
	PC6510	140~230	



Tangential type (Full side cutter)



• TAFCP(M)



• TAFCB(M)

Designation	Ød	E	ØD2	a	b	T-MAX	Designation	Ød	F	ØD2	a	b	E	T-MAX	Dimensions			
															ØD	W	No. of tooth	
TAFCP (M)	1001418	31.75 (32)	14	48	7.92 (8)	35.2	TAFCB (M)	1001418R/L	31.75 (32)	50	54	12.7 (14.4)	8	28	21	100	14-18	6
	1251418	38.1 (40)	14	56	9.52 (10)	42.3		1251418R/L	38.1 (40)	60	70	15.9 (16.4)	10	30	25	125	14-18	8
	1601418	38.1 (40)	14	56	9.52 (10)	42.3		1601418R/L	38.1 (40)	60	70	15.9 (16.4)	10	30	43	160	14-18	10
	2001418	50.8 (50)	14	72	12.7 (12)	55.8		2001418R/L	50.8 (40)	65	90	19.0 (16.4)	11	30	53	200	14-18	12
	2501418	50.8 (50)	14	72	12.7 (12)	55.8		2501418R/L	47.625 (60)	65	130	25.4 (25.7)	14	38	58	250	14-18	16
	3151418	50.8 (50)	14	72	12.7 (12)	55.8		3151418R/L	47.625 (60)	65	130	25.4 (25.7)	14	38	90	315	14-18	20
TAFCP (M)	1001821	31.75 (32)	18	48	7.92 (8)	35.2	TAFCB (M)	1001821R/L	31.75 (32)	50	50	12.7 (14.4)	8	28	21	100	18-21	6
	1251821	38.1 (40)	18	56	9.52 (10)	42.3		1251821R/L	38.1 (40)	60	70	15.9 (16.4)	10	30	25	125	18-21	8
	1601821	38.1 (40)	18	56	9.52 (10)	42.3		1601821R/L	38.1 (40)	60	70	15.9 (16.4)	10	30	43	160	18-21	10
	2001821	50.8 (50)	18	72	12.7 (12)	55.8		2001821R/L	50.8 (40)	65	90	19.0 (16.4)	11	30	53	200	18-21	12
	2501821	50.8 (50)	18	72	12.7 (12)	55.8		2501821R/L	47.625 (60)	65	130	25.4 (25.7)	14	38	58	250	18-21	16
	3151821	50.8 (50)	18	72	12.7 (12)	55.8		3151821R/L	47.625 (60)	65	130	25.4 (25.7)	14	38	90	315	18-21	20
TAFCP (M)	1002124	31.75 (32)	21	48	7.92 (8)	35.2	TAFCB (M)	1002124R/L	31.75 (32)	50	54	12.7 (14.4)	8	28	21	100	21-24	6
	1252124	38.1 (40)	21	56	9.52 (10)	42.3		1252124R/L	38.1 (40)	60	70	15.9 (16.4)	10	30	25	125	21-24	8
	1602124	38.1 (40)	21	56	9.52 (10)	42.3		1602124R/L	38.1 (40)	60	70	15.9 (16.4)	10	30	43	160	21-24	10
	2002124	50.8 (50)	21	72	12.7 (12)	55.8		2002124R/L	50.8 (40)	65	90	19.0 (16.4)	11	30	53	200	21-24	12
	2502124	50.8 (50)	21	72	12.7 (12)	55.8		2502124R/L	47.625 (60)	65	130	25.4 (25.7)	14	38	58	250	21-24	16
	3152124	50.8 (50)	21	72	12.7 (12)	55.8		3152124R/L	47.625 (60)	65	130	25.4 (25.7)	14	38	90	315	21-24	20
TAFCP (M)	1252427	38.1 (40)	24	56	9.52 (10)	42.3	TAFCB (M)	1252427R/L	38.1 (40)	60	70	15.9 (16.4)	10	30	25	125	24-27	8
	1602427	38.1 (40)	24	56	9.52 (10)	42.3		1602427R/L	38.1 (40)	60	70	15.9 (16.4)	10	30	43	160	24-27	10
	2002427	50.8 (50)	24	72	12.7 (12)	55.8		2002427R/L	50.8 (40)	65	90	19.0 (16.4)	11	30	53	200	24-27	12
	2502427	50.8 (50)	24	72	12.7 (12)	55.8		2502427R/L	47.625 (60)	65	130	25.4 (25.7)	14	38	58	250	24-27	16
	3152427	50.8 (50)	24	72	12.7 (12)	55.8		3152427R/L	47.625 (60)	65	130	25.4 (25.7)	14	38	90	315	24-27	20
	TAFCP (M)	1252730	38.1 (40)	27	56	9.52 (10)		42.3	TAFCB (M)	1252730R/L	38.1 (40)	60	70	15.9 (16.4)	10	30	25	125
1602730		38.1 (40)	27	56	9.52 (10)	42.3	1602730R/L	38.1 (40)		60	70	15.9 (16.4)	10	30	43	160	27-30	10
2002730		50.8 (50)	27	72	12.7 (12)	55.8	2002730R/L	50.8 (40)		65	90	19.0 (16.4)	11	30	53	200	27-30	12
2502730		50.8 (50)	27	72	12.7 (12)	55.8	2502730R/L	47.625 (60)		65	130	25.4 (25.7)	14	38	58	250	27-30	16
3152730		50.8 (50)	27	72	12.7 (12)	55.8	3152730R/L	47.625 (60)		65	130	25.4 (25.7)	14	38	90	315	27-30	20

Available inserts and Recommended cutting condition **E406** • The ap (Maximum width of cutter) size written above is the number when using insert having corner size C0.5 or R0.5 () Metric size

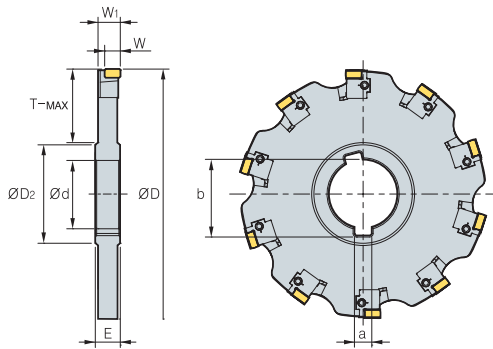
Parts

Specification	Insert	Locator	Wedge	Insert screw	Wedge screw	Locator screw	Insert wrench	Wedge Wrench	Locator Wrench
□□□1418R/L	CNHQ1005-□□□	LSA-CH10R/L	WSA10N	FTKA0410	DHA0617	SHGA0411	TW15S	HW30	-
□□□1821R/L	CNHQ1305-□□□	LSA-CH13R/L	WSA13N	FTKA0410	DHA0821F	SHGA0411	TW15S	HW40	HW30L
□□□2124R/L	CNHQ1305-□□□	LSA-CH13R/L	WSA13N	FTKA0410	DHA0821F	SHGA0411	TW15S	HW40	HW30L
□□□2427R/L	CNHQ1606-□□□	LSA-CH16R/L	WSA13N	FTGA0513-P	DHA0821F	SHGA0411	TW20S	HW40	HW30L
□□□2730R/L	CNHQ1606-□□□	LSA-CH16R/L	WSA13N	FTGA0513-P	DHA0821F	SHGA0411	TW20S	HW40	HW30L

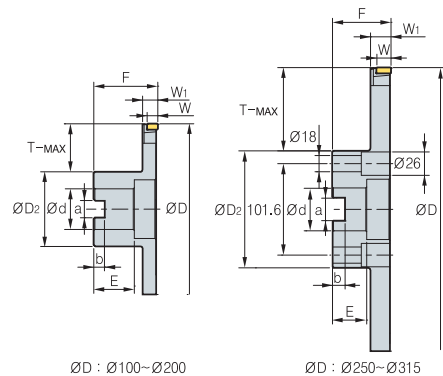
• Note) The Wedge screw for 1001821, 1002124 cutter is DHA0818F



Tangential type (Half side cutter)



• TAHCP(M)



ØD : Ø100~Ø200

ØD : Ø250~Ø315

• TAHCB(M)

(mm)

Designation	Ød	E	ØD2	a	b	T-MAX	Designation	Ød	F	ØD2	a	b	E	T-MAX	Dimensions					
															ØD	W	W1	No. of tooth		
TAHCP (M) 10014R/L	31.75 (32)	14	48	7.92 (8)	35.2	24	TAHCB (M) 10014R/L	31.75 (32)	50	54	12.7 (14.4)	8	28	21	100	9	13.25	6		
	12514R/L	38.1 (40)	14	56	9.52 (10)	42.3		32	12514R/L	38.1 (40)	60	70	15.9 (16.4)	10	30	25	125	9	13.25	8
	16014R/L	38.1 (40)	14	56	9.52 (10)	42.3		50	16014R/L	38.1 (40)	60	70	15.9 (16.4)	10	30	43	160	9	13.25	10
	20014R/L	50.8 (50)	14	72	12.7 (12)	55.8		61	20014R/L	50.8 (40)	65	90	19.0 (16.4)	11	30	53	200	9	13.25	12
	25014R/L	50.8 (50)	14	72	12.7 (12)	55.8		86	25014R/L	47.625 (60)	65	130	25.4 (25.7)	14	38	58	250	9	13.25	16
31514R/L	50.8 (50)	14	72	12.7 (12)	55.8	118	31514R/L	47.625 (60)	65	130	25.4 (25.7)	14	38	90	315	9	13.25	20		
TAHCP (M) 10018R/L	31.75 (32)	18	48	7.92 (8)	35.2	24	TAHCB (M) 10018R/L	31.75 (32)	50	50	12.7 (14.4)	8	28	21	100	12	16.75	6		
	12518R/L	38.1 (40)	18	56	9.52 (10)	42.3		32	12518R/L	38.1 (40)	60	70	15.9 (16.4)	10	30	25	125	12	16.75	8
	16018R/L	38.1 (40)	18	56	9.52 (10)	42.3		50	16018R/L	38.1 (40)	60	70	15.9 (16.4)	10	30	43	160	12	16.75	10
	20018R/L	50.8 (50)	18	72	12.7 (12)	55.8		61	20018R/L	50.8 (40)	65	90	19.0 (16.4)	11	30	53	200	12	16.75	12
	25018R/L	50.8 (50)	18	72	12.7 (12)	55.8		86	25018R/L	47.625 (60)	65	130	25.4 (25.7)	14	38	58	250	12	16.75	16
31518R/L	50.8 (50)	18	72	12.7 (12)	55.8	118	31518R/L	47.625 (60)	65	130	25.4 (25.7)	14	38	90	315	12	16.75	20		
TAHCP (M) 10021R/L	31.75 (32)	21	48	7.92 (8)	35.2	24	TAHCB (M) 10021R/L	31.75 (32)	50	54	12.7 (14.4)	8	28	21	100	12	19.75	6		
	12521R/L	38.1 (40)	21	56	9.52 (10)	42.3		32	12521R/L	38.1 (40)	60	70	15.9 (16.4)	10	30	25	125	12	19.75	8
	16021R/L	38.1 (40)	21	56	9.52 (10)	42.3		50	16021R/L	38.1 (40)	60	70	15.9 (16.4)	10	30	43	160	12	19.75	10
	20021R/L	50.8 (50)	21	72	12.7 (12)	55.8		61	20021R/L	50.8 (40)	65	90	19.0 (16.4)	11	30	53	200	12	19.75	12
	25021R/L	50.8 (50)	21	72	12.7 (12)	55.8		86	25021R/L	47.625 (60)	65	130	25.4 (25.7)	14	38	58	250	12	19.75	16
31521R/L	50.8 (50)	21	72	12.7 (12)	55.8	118	31521R/L	47.625 (60)	65	130	25.4 (25.7)	14	38	90	315	12	19.75	20		
TAHCP (M) 12524R/L	38.1 (40)	24	56	9.52 (10)	42.3	32	TAHCB (M) 12524R/L	38.1 (40)	60	70	15.9 (16.4)	10	30	25	125	15	22.75	8		
	16024R/L	38.1 (40)	24	56	9.52 (10)	42.3		50	16024R/L	38.1 (40)	60	70	15.9 (16.4)	10	30	43	160	15	22.75	10
	20024R/L	50.8 (50)	24	72	12.7 (12)	55.8		61	20024R/L	50.8 (40)	65	90	19.0 (16.4)	11	30	53	200	15	22.75	12
	25024R/L	50.8 (50)	24	72	12.7 (12)	55.8		86	25024R/L	47.625 (60)	65	130	25.4 (25.7)	14	38	58	250	15	22.75	16
	31524R/L	50.8 (50)	24	72	12.7 (12)	55.8		118	31524R/L	47.625 (60)	65	130	25.4 (25.7)	14	38	90	315	15	22.75	20
TAHCP (M) 12527R/L	38.1 (40)	27	56	9.52 (10)	42.3	32	TAHCB (M) 12527R/L	38.1 (40)	60	70	15.9 (16.4)	10	30	25	125	15	25.75	8		
	16027R/L	38.1 (40)	27	56	9.52 (10)	42.3		50	16027R/L	38.1 (40)	60	70	15.9 (16.4)	10	30	43	160	15	25.75	10
	20027R/L	50.8 (50)	27	72	12.7 (12)	55.8		61	20027R/L	50.8 (40)	65	90	19.0 (16.4)	11	30	53	200	15	25.75	12
	25027R/L	50.8 (50)	27	72	12.7 (12)	55.8		86	25027R/L	47.625 (60)	65	130	25.4 (25.7)	14	38	58	250	15	25.75	16
	31527R/L	50.8 (50)	27	72	12.7 (12)	55.8		118	31527R/L	47.625 (60)	65	130	25.4 (25.7)	14	38	90	315	15	25.75	20

Available inserts and Recommended cutting condition **E406** • The ap (Maximum width of cutter) size written above is the number when using insert having corner size C0.5 or R0.5 ()Metric size

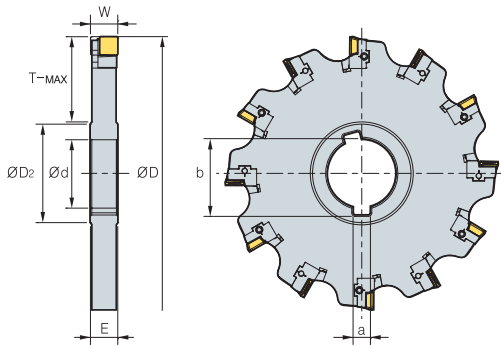
Parts

Specification	Insert	Locator	Wedge	Insert screw	Wedge screw	Locator screw	Insert wrench	Wedge Wrench	Locator Wrench
□□□1418R/L	CNHQ1005-□□□	LSA-CH10R/L	WSA10N	FTKA0410	DHA0617	SHGA0411	TW15S	HW30	-
□□□1821R/L	CNHQ1305-□□□	LSA-CH13R/L	WSA13N	FTKA0410	DHA0821F	SHGA0411	TW15S	HW40	HW30L
□□□2124R/L	CNHQ1305-□□□	LSA-CH13R/L	WSA13N	FTKA0410	DHA0821F	SHGA0411	TW15S	HW40	HW30L
□□□2427R/L	CNHQ1606-□□□	LSA-CH16R/L	WSA13N	FTGA0513-P	DHA0821F	SHGA0411	TW20S	HW40	HW30L
□□□2730R/L	CNHQ1606-□□□	LSA-CH16R/L	WSA13N	FTGA0513-P	DHA0821F	SHGA0411	TW20S	HW40	HW30L

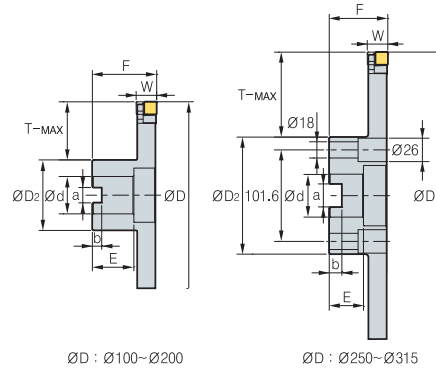
• Note) The Wedge screw for 10018, 10021 cutter is DHA0818F



Radial type (Full side cutter)



• RAFCP(M)



• RAFCB(M)

(mm)

Designation	Ød	E	ØD2	a	b	T-MAX	Designation	Ød	F	ØD2	a	b	E	T-MAX	Dimensions		
															ØD	W	No. of tooth
RAFCP (M) 1001214 1251214 1601214 2001214 2501214 3151214	31.75 (32)	12	48	7.92 (8)	35.2	24	RAFCB (M) 1001214R/L 1251214R/L 1601214R/L 2001214R/L 2501214R/L 3151214R/L	31.75 (32)	50	54	12.7 (14.4)	8	28	21	100	12-14	6
	38.1 (40)	12	56	9.52 (10)	42.3	32		38.1 (40)	60	70	15.9 (16.4)	10	30	25	125	12-14	8
	38.1 (40)	12	56	9.52 (10)	42.3	50		38.1 (40)	60	70	15.9 (16.4)	10	30	43	160	12-14	10
	50.8 (50)	12	72	12.7 (12)	55.8	61		50.8 (40)	65	90	19.0 (16.4)	11	30	53	200	12-14	12
	50.8 (50)	12	72	12.7 (12)	55.8	86		47.625 (60)	65	130	25.4 (25.7)	14	38	58	250	12-14	16
	50.8 (50)	12	72	12.7 (12)	55.8	118		47.625 (60)	65	130	25.4 (25.7)	14	38	90	315	12-14	20
RAFCP (M) 1001416 1251416 1601416 2001416 2501416 3151416	31.75 (32)	14	48	7.92 (8)	35.2	24	RAFCB (M) 1001416R/L 1251416R/L 1601416R/L 2001416R/L 2501416R/L 3151416R/L	31.75 (32)	50	50	12.7 (14.4)	8	28	21	100	14-16	6
	38.1 (40)	14	56	9.52 (10)	42.3	32		38.1 (40)	60	70	15.9 (16.4)	10	30	25	125	14-16	8
	38.1 (40)	14	56	9.52 (10)	42.3	50		38.1 (40)	60	70	15.9 (16.4)	10	30	43	160	14-16	10
	50.8 (50)	14	72	12.7 (12)	55.8	61		50.8 (40)	65	90	19.0 (16.4)	11	30	53	200	14-16	12
	50.8 (50)	14	72	12.7 (12)	55.8	86		47.625 (60)	65	130	25.4 (25.7)	14	38	58	250	14-16	16
	50.8 (50)	14	72	12.7 (12)	55.8	118		47.625 (60)	65	130	25.4 (25.7)	14	38	90	315	14-16	20
RAFCP (M) 1251618 1601618 2001618 2501618 3151618	38.1 (40)	16	56	9.52 (10)	42.3	32	RAFCB (M) 1251618R/L 1601618R/L 2001618R/L 2501618R/L 3151618R/L	38.1 (40)	60	70	15.9 (16.4)	10	30	25	125	16-18	8
	38.1 (40)	16	56	9.52 (10)	42.3	50		38.1 (40)	60	70	15.9 (16.4)	10	30	43	160	16-18	10
	50.8 (50)	16	72	12.7 (12)	55.8	61		50.8 (40)	65	90	19.0 (16.4)	11	30	53	200	16-18	12
	50.8 (50)	16	72	12.7 (12)	55.8	86		47.625 (60)	65	130	25.4 (25.7)	14	38	58	250	16-18	16
	50.8 (50)	16	72	12.7 (12)	55.8	118		47.625 (60)	65	130	25.4 (25.7)	14	38	90	315	16-18	20
	RAFCP (M) 1251820 1601820 2001820 2501820 3151820	38.1 (40)	18	56	9.52 (10)	42.3		32	RAFCB (M) 1251820R/L 1601820R/L 2001820R/L 2501820R/L 3151820R/L	38.1 (40)	60	70	15.9 (16.4)	10	30	25	125
38.1 (40)		18	56	9.52 (10)	42.3	50	38.1 (40)	60		70	15.9 (16.4)	10	30	43	160	18-20	10
50.8 (50)		18	72	12.7 (12)	55.8	61	50.8 (40)	65		90	19.0 (16.4)	11	30	53	200	18-20	12
50.8 (50)		18	72	12.7 (12)	55.8	86	47.625 (60)	65		130	25.4 (25.7)	14	38	58	250	18-20	16
50.8 (50)		18	72	12.7 (12)	55.8	118	47.625 (60)	65		130	25.4 (25.7)	14	38	90	315	18-20	20
RAFCP (M) 1252022 1602022 2002022 2502022 3152022		38.1 (40)	20	56	9.52 (10)	42.3	32	RAFCB (M) 1252022R/L 1602022R/L 2002022R/L 2502022R/L 3152022R/L		38.1 (40)	60	70	15.9 (16.4)	10	30	25	125
	38.1 (40)	20	56	9.52 (10)	42.3	50	38.1 (40)		60	70	15.9 (16.4)	10	30	43	160	20-22	10
	50.8 (50)	20	72	12.7 (12)	55.8	61	50.8 (40)		65	90	19.0 (16.4)	11	30	53	200	20-22	12
	50.8 (50)	20	72	12.7 (12)	55.8	86	47.625 (60)		65	130	25.4 (25.7)	14	38	58	250	20-22	16
	50.8 (50)	20	72	12.7 (12)	55.8	118	47.625 (60)		65	130	25.4 (25.7)	14	38	90	315	20-22	20
	RAFCP (M) 1252224 1602224 2002224 2502224 3152224	38.1 (40)	22	56	9.52 (10)	42.3	32		RAFCB (M) 1252224R/L 1602224R/L 2002224R/L 2502224R/L 3152224R/L	38.1 (40)	60	70	15.9 (16.4)	10	30	25	125
38.1 (40)		22	56	9.52 (10)	42.3	50	38.1 (40)	60		70	15.9 (16.4)	10	30	43	160	22-24	10
50.8 (50)		22	72	12.7 (12)	55.8	61	50.8 (40)	65		90	19.0 (16.4)	11	30	53	200	22-24	12
50.8 (50)		22	72	12.7 (12)	55.8	86	47.625 (60)	65		130	25.4 (25.7)	14	38	58	250	22-24	16
50.8 (50)		22	72	12.7 (12)	55.8	118	47.625 (60)	65		130	25.4 (25.7)	14	38	90	315	22-24	20

Available inserts and Recommended cutting condition **E406** • The ap (Maximum width of cutter) size written above is the number when using insert having corner size C0.5 or R0.5

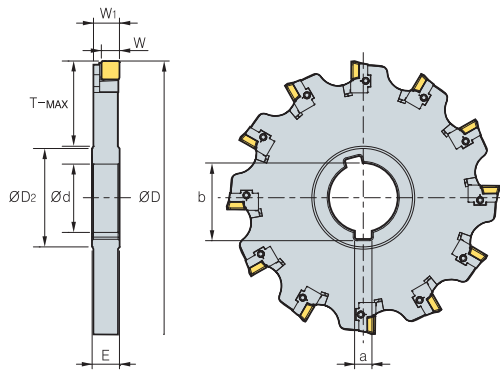
() Metric size

Parts

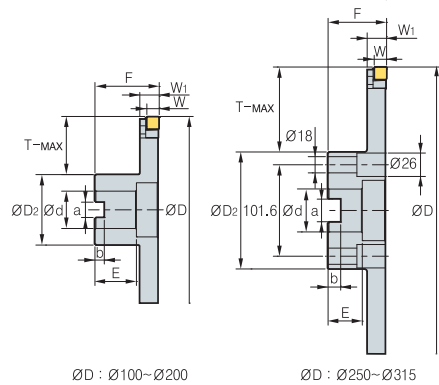
Specification	Insert	Locator	WSD09N Wedge	WSA10N Wedge	Insert screw	Wedge screw	Locator screw	Insert wrench	Wedge, locator wrench
□□□1214R/L	SDXT09M40□R/L	LSD09R/L	WSD09N	WSA10N	FTGA03508	DHA0617	SHGA0409	TW15S	HW30
□□□1416R/L	SDXT09M40□R/L	LSD09R/L	WSD09N	WSA10N	FTGA03508	DHA0617	SHGA0409	TW15S	HW30
□□□1618R/L	SDXT13050□R/L	LSD13R/L	WSD09N	WSA10N	FTNC04509	DHA0617	SHGA0411	TW20S	HW30
□□□1820R/L	SDXT13050□R/L	LSD13R/L	WSD09N	WSA10N	FTNC04509	DHA0617	SHGA0411	TW20S	HW30
□□□2022R/L	SDXT13050□R/L	LSD13R/L	WSD09N	WSA10N	FTNC04509	DHA0617	SHGA0411	TW20S	HW30
□□□2224R/L	SDXT13050□R/L	LSD13R/L	WSD09N	WSA10N	FTNC04509	DHA0617	SHGA0411	TW20S	HW30



Radial type (Half side cutter)



• RAHCP(M)



• RAHCB(M)

(mm)

Designation	Ød	E	ØD2	a	b	T-MAX	Designation	Ød	F	ØD2	a	b	E	T-MAX	Dimensions			
															ØD	W	W1	No. of tooth
RAHCP 10012R/L	31.75 (32)	12	48	7.92 (8)	35.2	24	RAHCB 10012R/L	31.75 (32)	50	54	12.7 (14.4)	8	28	21	100	8	11.1	6
(M) 12512R/L	38.1 (40)	12	56	9.52 (10)	42.3	32	(M) 12512R/L	38.1 (40)	60	70	15.9 (16.4)	10	30	25	125	8	11.1	8
16012R/L	38.1 (40)	12	56	9.52 (10)	42.3	50	16012R/L	38.1 (40)	60	70	15.9 (16.4)	10	30	43	160	8	11.1	10
20012R/L	50.8 (50)	12	72	12.7 (12)	55.8	61	20012R/L	50.8 (40)	65	90	19.0 (16.4)	11	30	53	200	8	11.1	12
25012R/L	50.8 (50)	12	72	12.7 (12)	55.8	86	25012R/L	47.625 (60)	65	130	25.4 (25.7)	14	38	58	250	8	11.1	16
31512R/L	50.8 (50)	12	72	12.7 (12)	55.8	118	31512R/L	47.625 (60)	65	130	25.4 (25.7)	14	38	90	315	8	11.1	20
RAHCP 10014R/L	31.75 (32)	14	48	7.92 (8)	35.2	24	RAHCB 10014R/L	31.75 (32)	50	50	12.7 (14.4)	8	28	21	100	8	13.1	6
(M) 12514R/L	38.1 (40)	14	56	9.52 (10)	42.3	32	(M) 12514R/L	38.1 (40)	60	70	15.9 (16.4)	10	30	25	125	8	13.1	8
16014R/L	38.1 (40)	14	56	9.52 (10)	42.3	50	16014R/L	38.1 (40)	60	70	15.9 (16.4)	10	30	43	160	8	13.1	10
20014R/L	50.8 (50)	14	72	12.7 (12)	55.8	61	20014R/L	50.8 (40)	65	90	19.0 (16.4)	11	30	53	200	8	13.1	12
25014R/L	50.8 (50)	14	72	12.7 (12)	55.8	86	25014R/L	47.625 (60)	65	130	25.4 (25.7)	14	38	58	250	8	13.1	16
31514R/L	50.8 (50)	14	72	12.7 (12)	55.8	118	31514R/L	47.625 (60)	65	130	25.4 (25.7)	14	38	90	315	8	13.1	20
RAHCP 12516R/L	38.1 (40)	16	56	9.52 (10)	42.3	32	RAHCB 12516R/L	38.1 (40)	60	70	15.9 (16.4)	10	30	25	125	10.5	15	8
(M) 16016R/L	38.1 (40)	16	56	9.52 (10)	42.3	50	(M) 16016R/L	38.1 (40)	60	70	15.9 (16.4)	10	30	43	160	10.5	15	10
20016R/L	50.8 (50)	16	72	12.7 (12)	55.8	61	20016R/L	50.8 (40)	65	90	19.0 (16.4)	11	30	53	200	10.5	15	12
25016R/L	50.8 (50)	16	72	12.7 (12)	55.8	86	25016R/L	47.625 (60)	65	130	25.4 (25.7)	14	38	58	250	10.5	15	16
31516R/L	50.8 (50)	16	72	12.7 (12)	55.8	118	31516R/L	47.625 (60)	65	130	25.4 (25.7)	14	38	90	315	10.5	15	20
RAHCP 12518R/L	38.1 (40)	18	56	9.52 (10)	42.3	32	RAHCB 12518R/L	38.1 (40)	60	70	15.9 (16.4)	10	30	25	125	10.5	17	8
(M) 16018R/L	38.1 (40)	18	56	9.52 (10)	42.3	50	(M) 16018R/L	38.1 (40)	60	70	15.9 (16.4)	10	30	43	160	10.5	17	10
20018R/L	50.8 (50)	18	72	12.7 (12)	55.8	61	20018R/L	50.8 (40)	65	90	19.0 (16.4)	11	30	53	200	10.5	17	12
25018R/L	50.8 (50)	18	72	12.7 (12)	55.8	86	25018R/L	47.625 (60)	65	130	25.4 (25.7)	14	38	58	250	10.5	17	16
31518R/L	50.8 (50)	18	72	12.7 (12)	55.8	118	31518R/L	47.625 (60)	65	130	25.4 (25.7)	14	38	90	315	10.5	17	20
RAHCP 12520R/L	38.1 (40)	20	56	9.52 (10)	42.3	32	RAHCB 12520R/L	38.1 (40)	60	70	15.9 (16.4)	10	30	25	125	10.5	19	8
(M) 16020R/L	38.1 (40)	20	56	9.52 (10)	42.3	50	(M) 16020R/L	38.1 (40)	60	70	15.9 (16.4)	10	30	43	160	10.5	19	10
20020R/L	50.8 (50)	20	72	12.7 (12)	55.8	61	20020R/L	50.8 (40)	65	90	19.0 (16.4)	11	30	53	200	10.5	19	12
25020R/L	50.8 (50)	20	72	12.7 (12)	55.8	86	25020R/L	47.625 (60)	65	130	25.4 (25.7)	14	38	58	250	10.5	19	16
31520R/L	50.8 (50)	20	72	12.7 (12)	55.8	118	31520R/L	47.625 (60)	65	130	25.4 (25.7)	14	38	90	315	10.5	19	20
RAHCP 12522R/L	38.1 (40)	22	56	9.52 (10)	42.3	32	RAHCB 12522R/L	38.1 (40)	60	70	15.9 (16.4)	10	30	25	125	10.5	21	8
(M) 16022R/L	38.1 (40)	22	56	9.52 (10)	42.3	50	(M) 16022R/L	38.1 (40)	60	70	15.9 (16.4)	10	30	43	160	10.5	21	10
20022R/L	50.8 (50)	22	72	12.7 (12)	55.8	61	20022R/L	50.8 (40)	65	90	19.0 (16.4)	11	30	53	200	10.5	21	12
25022R/L	50.8 (50)	22	72	12.7 (12)	55.8	86	25022R/L	47.625 (60)	65	130	25.4 (25.7)	14	38	58	250	10.5	21	16
31522R/L	50.8 (50)	22	72	12.7 (12)	55.8	118	31522R/L	47.625 (60)	65	130	25.4 (25.7)	14	38	90	315	10.5	21	20

Available inserts and Recommended cutting condition **E406**

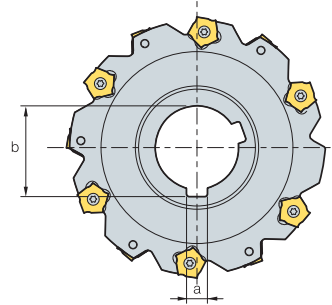
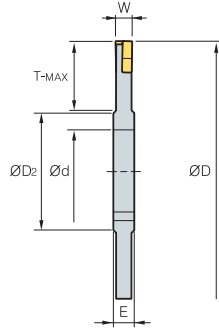
- The ap (Maximum width of cutter) size written above is the number when using insert having corner size R0.5. The ap is subject to change as per insert corner size
- The ap (Maximum width of cutter) size written above is the number when using SDXT09M405R-MM. The ap is subject to change as per insert corner size ()Metric size

Parts

Specification	Insert	Locator	Wedge	Insert screw	Wedge screw	Locator screw	Insert wrench	Wedge, locator wrench
□□□1214R/L	SDXT09M40□R/L	LSD09R/L	WSD09N	FTGA03508	DHA0617	SHGA0409	TW15S	HW30
□□□1416R/L	SDXT09M40□R/L	LSD09R/L	WSD09N	FTGA03508	DHA0617	SHGA0409	TW15S	HW30
□□□1618R/L	SDXT13050□R/L	LSD13R/L	WSA10N	FTNC04509	DHA0617	SHGA0411	TW20S	HW30
□□□1820R/L	SDXT13050□R/L	LSD13R/L	WSA10N	FTNC04509	DHA0617	SHGA0411	TW20S	HW30
□□□2022R/L	SDXT13050□R/L	LSD13R/L	WSA10N	FTNC04509	DHA0617	SHGA0411	TW20S	HW30
□□□2224R/L	SDXT13050□R/L	LSD13R/L	WSA10N	FTNC04509	DHA0617	SHGA0411	TW20S	HW30



SPP(M)



(mm)

Designation	ØD	W	T-MAX	Ød	a	b	E	ØD2	Insert	Screw	Wrench	
SPP 080-04	8	80	4	20	25.4 (27)	6.35 (7)	28.04 (29.8)	8	40	PNEJ1223N	PTMA0403F	TW15S
(SPPM) 080-05	8	80	5	20	25.4 (27)	6.35 (7)	28.04 (29.8)	8	40	PNEJ1230N	PTMA0404F	TW15S
080-06	8	80	6	20	25.4 (27)	6.35 (7)	28.04 (29.8)	8	40	PNEJ1235N	PTMA0405F	TW15S
100-04	10	100	4	24	31.75 (32)	7.94 (8)	35.18 (34.8)	8	47	PNEJ1223N	PTMA0403F	TW15S
100-05	10	100	5	24	31.75 (32)	7.94 (8)	35.18 (34.8)	8	47	PNEJ1230N	PTMA0404F	TW15S
100-06	10	100	6	25	31.75 (32)	7.94 (8)	35.18 (34.8)	8	47	PNEJ1235N	PTMA0405F	TW15S
100-07	10	100	7	25	31.75 (32)	7.94 (8)	35.18 (34.8)	10	47	PNEJ1240N	PTMA0406F	TW15S
100-08	10	100	8	25	31.75 (32)	7.94 (8)	35.18 (34.8)	10	47	PNEJ1245N	PTKA0407F	TW15S
100-09	10	100	9	25	31.75 (32)	7.94 (8)	35.18 (34.8)	12	47	PNEJ1250N	PTKA0408F	TW15S
100-10	10	100	10	25	31.75 (32)	7.94 (8)	35.18 (34.8)	12	47	PNEJ1255N	PTKA0409F	TW15S
125-04	12	125	4	30	38.1 (40)	9.53 (10)	42.32 (43.5)	8	56	PNEJ1223N	PTMA0403F	TW15S
125-05	12	125	5	32	38.1 (40)	9.53 (10)	42.32 (43.5)	8	56	PNEJ1230N	PTMA0404F	TW15S
125-06	12	125	6	32	38.1 (40)	9.53 (10)	42.32 (43.5)	8	56	PNEJ1235N	PTMA0405F	TW15S
125-07	12	125	7	32	38.1 (40)	9.53 (10)	42.32 (43.5)	10	56	PNEJ1240N	PTMA0406F	TW15S
125-08	12	125	8	32	38.1 (40)	9.53 (10)	42.32 (43.5)	10	56	PNEJ1245N	PTKA0407F	TW15S
125-09	12	125	9	32	38.1 (40)	9.53 (10)	42.32 (43.5)	12	56	PNEJ1250N	PTKA0408F	TW15S
125-10	12	125	10	32	38.1 (40)	9.53 (10)	42.32 (43.5)	12	56	PNEJ1255N	PTKA0409F	TW15S
160-04	16	160	4	45	38.1 (40)	9.53 (10)	42.32 (43.5)	8	66	PNEJ1223N	PTMA0403F	TW15S
160-05	16	160	5	45	38.1 (40)	9.53 (10)	42.32 (43.5)	8	66	PNEJ1230N	PTMA0404F	TW15S
160-06	16	160	6	45	38.1 (40)	9.53 (10)	42.32 (43.5)	8	66	PNEJ1235N	PTMA0405F	TW15S
160-07	16	160	7	45	38.1 (40)	9.53 (10)	42.32 (43.5)	10	66	PNEJ1240N	PTMA0406F	TW15S
160-08	16	160	8	45	38.1 (40)	9.53 (10)	42.32 (43.5)	10	66	PNEJ1245N	PTKA0407F	TW15S
160-09	16	160	9	45	38.1 (40)	9.53 (10)	42.32 (43.5)	12	66	PNEJ1250N	PTKA0408F	TW15S
160-10	16	160	10	45	38.1 (40)	9.53 (10)	42.32 (43.5)	12	66	PNEJ1255N	PTKA0409F	TW15S
160-11	16	160	11	45	38.1 (40)	9.53 (10)	42.32 (43.5)	14	66	PNEJ1260N	PTKA0410F	TW15S
160-12	16	160	12	45	38.1 (40)	9.53 (10)	42.32 (43.5)	14	66	PNEJ1265N	PTKA0411F	TW15S
160-13	16	160	13	45	38.1 (40)	9.53 (10)	42.32 (43.5)	16	66	PNEJ1270N	PTKA0412F	TW15S
160-14	16	160	14	45	38.1 (40)	9.53 (10)	42.32 (43.5)	16	66	PNEJ1275N	PTKA0413F	TW15S
200-06	18	200	6	60	50.8 (50)	12.7 (12)	55.83 (53.5)	8	70	PNEJ1235N	PTMA0405F	TW15S
200-07	18	200	7	60	50.8 (50)	12.7 (12)	55.83 (53.5)	10	70	PNEJ1240N	PTMA0406F	TW15S
200-08	18	200	8	60	50.8 (50)	12.7 (12)	55.83 (53.5)	10	70	PNEJ1245N	PTKA0407F	TW15S
200-09	18	200	9	60	50.8 (50)	12.7(12)	55.83 (53.5)	12	70	PNEJ1250N	PTKA0408F	TW15S
200-10	18	200	10	60	50.8 (50)	12.7 (12)	55.83 (53.5)	12	70	PNEJ1255N	PTKA0409F	TW15S
200-11	18	200	11	60	50.8 (50)	12.7 (12)	55.83 (53.5)	14	70	PNEJ1260N	PTKA0410F	TW15S
200-12	18	200	12	60	50.8 (50)	12.7 (12)	55.83 (53.5)	14	70	PNEJ1265N	PTKA0411F	TW15S
200-13	18	200	13	60	50.8 (50)	12.7 (12)	55.83 (53.5)	16	70	PNEJ1270N	PTKA0412F	TW15S
200-14	18	200	14	60	50.8 (50)	12.7 (12)	55.83 (53.5)	16	70	PNEJ1275N	PTKA0413F	TW15S

Available arbors

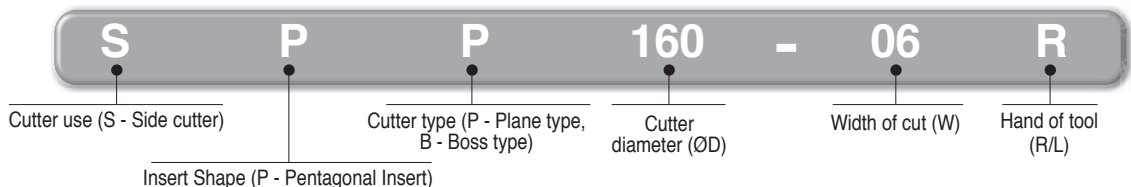
Designation	NC arbors		
	BT30	BT40	BT50
SPP 080-04~06	BT30-SCA25.4-60	BT40-SCA25.4-75/120	BT50-SCA25.4-90/135
100-04~10	-	BT40-SCA31.75-105	BT50-SCA31.75-90/135
125-04~09	-	-	BT50-SCA38.1-90/135
160-04~14	-	-	BT50-SCA38.1-90/135
200-06~14	-	-	-
SPPM 080-04~06	-	BT40-SCA27-75/120	BT50-SCA27-90/135
100-04~10	-	BT40-SCA32-105	BT50-SCA32-90/135
125-04~09	-	-	BT50-SCA40-90/135
160-04~14	-	-	BT50-SCA40-90/135
200-06~14	-	-	-

Recommended cutting condition

() Metric size

Workpiece	Cutting condition		Grades
	vc (m/min)	fz (mm/t)	
P	190~310 160~270 60~100	0.10~0.25 0.10~0.30 0.10~0.25	NCM325 PC3700 ST30A
M	90~150 80~150	0.10~0.25 0.10~0.30	PC9530 ST30A
K	140~230 50~90	0.10~0.35 0.10~0.40	PC6510 G10

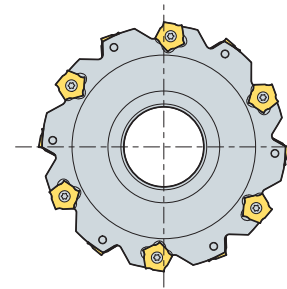
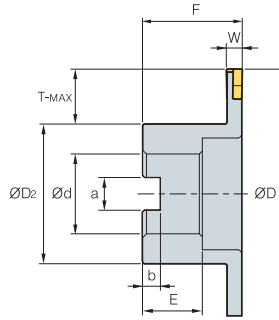
Code system



Available inserts **E16** Available arbors and bolt **E426~E428**



SPB(M)



• AR: -2°
• RR: 28°

(mm)

Designation	ØD	W	T-MAX	ØD2	Ød	a	b	F	E	Insert	Screw	Wrench	
SPB 080-04R/L	8	80	4	18	40	25.4 (27)	9.5 (12.4)	6 (7)	50	25 (22)	PNEJ1223N	PTMA0403F	TW15S
(SPBM) 080-05R/L	8	80	5	18	40	25.4 (27)	9.5 (12.4)	6 (7)	50	25 (22)	PNEJ1230N	PTMA0404F	TW15S
080-06R/L	8	80	6	18	40	25.4 (27)	9.5 (12.4)	6 (7)	50	25 (22)	PNEJ1235N	PTMA0405F	TW15S
100-04R/L	10	100	4	21	54	31.75 (32)	12.7 (14.4)	8 (8)	50	32 (28)	PNEJ1223N	PTMA0403F	TW15S
100-05R/L	10	100	5	21	54	31.75 (32)	12.7 (14.4)	8 (8)	50	32 (28)	PNEJ1230N	PTMA0404F	TW15S
100-06R/L	10	100	6	21	54	31.75 (32)	12.7 (14.4)	8 (8)	50	32 (28)	PNEJ1235N	PTMA0405F	TW15S
100-07R/L	10	100	7	21	54	31.75 (32)	12.7 (14.4)	8 (8)	50	32 (28)	PNEJ1240N	PTMA0406F	TW15S
100-08R/L	10	100	8	21	54	31.75 (32)	12.7 (14.4)	8 (8)	50	32 (28)	PNEJ1245N	PTMA0407F	TW15S
100-09R/L	10	100	9	21	54	31.75 (32)	12.7 (14.4)	8 (8)	50	32 (28)	PNEJ1250N	PTMA0408F	TW15S
100-10R/L	10	100	10	21	54	31.75 (32)	12.7 (14.4)	8 (8)	50	32 (28)	PNEJ1255N	PTMA0409F	TW15S
125-04R/L	12	125	4	25	70	38.1 (40)	15.9 (16.4)	10 (9)	60 (50)	38 (30)	PNEJ1223N	PTMA0403F	TW15S
125-05R/L	12	125	5	25	70	38.1 (40)	15.9 (16.4)	10 (9)	60 (50)	38 (30)	PNEJ1230N	PTMA0404F	TW15S
125-06R/L	12	125	6	25	70	38.1 (40)	15.9 (16.4)	10 (9)	60 (50)	38 (30)	PNEJ1235N	PTMA0405F	TW15S
125-07R/L	12	125	7	25	70	38.1 (40)	15.9 (16.4)	10 (9)	60 (50)	38 (30)	PNEJ1240N	PTMA0406F	TW15S
125-08R/L	12	125	8	25	70	38.1 (40)	15.9 (16.4)	10 (9)	60 (50)	38 (30)	PNEJ1245N	PTKA0407F	TW15S
125-09R/L	12	125	9	25	70	38.1 (40)	15.9 (16.4)	10 (9)	60 (50)	38 (30)	PNEJ1250N	PTKA0408F	TW15S
125-10R/L	12	125	10	25	70	38.1 (40)	15.9 (16.4)	10 (9)	60 (50)	38 (30)	PNEJ1255N	PTKA0409F	TW15S
160-04R/L	16	160	4	43	70	38.1 (40)	15.9 (16.4)	10 (9)	60 (50)	38 (30)	PNEJ1223N	PTMA0403F	TW15S
160-05R/L	16	160	5	43	70	38.1 (40)	15.9 (16.4)	10 (9)	60 (50)	38 (30)	PNEJ1230N	PTMA0404F	TW15S
160-06R/L	16	160	6	43	70	38.1 (40)	15.9 (16.4)	10 (9)	60 (50)	38 (30)	PNEJ1235N	PTMA0405F	TW15S
160-07R/L	16	160	7	43	70	38.1 (40)	15.9 (16.4)	10 (9)	60 (50)	38 (30)	PNEJ1240N	PTMA0406F	TW15S
160-08R/L	16	160	8	43	70	38.1 (40)	15.9 (16.4)	10 (9)	60 (50)	38 (30)	PNEJ1245N	PTKA0407F	TW15S
160-09R/L	16	160	9	43	70	38.1 (40)	15.9 (16.4)	10 (9)	60 (50)	38 (30)	PNEJ1250N	PTKA0408F	TW15S
160-10R/L	16	160	10	43	70	38.1 (40)	15.9 (16.4)	10 (9)	60 (50)	38 (30)	PNEJ1255N	PTKA0409F	TW15S
160-11R/L	16	160	11	43	70	38.1 (40)	15.9 (16.4)	10 (9)	60 (50)	38 (30)	PNEJ1260N	PTKA0410F	TW15S
160-12R/L	16	160	12	43	70	38.1 (40)	15.9 (16.4)	10 (9)	60 (50)	38 (30)	PNEJ1265N	PTKA0411F	TW15S
160-13R/L	16	160	13	43	70	38.1 (40)	15.9 (16.4)	10 (9)	60 (50)	38 (30)	PNEJ1270N	PTKA0412F	TW15S
160-14R/L	16	160	14	43	70	38.1 (40)	15.9 (16.4)	10 (9)	60 (50)	38 (30)	PNEJ1275N	PTKA0413F	TW15S
200-06R/L	18	200	6	53	90	50.8 (40)	19 (16.4)	11 (9)	65	38 (30)	PNEJ1235N	PTMA0405F	TW15S
200-07R/L	18	200	7	53	90	50.8 (40)	19 (16.4)	11 (9)	65	38 (30)	PNEJ1240N	PTMA0406F	TW15S
200-08R/L	18	200	8	53	90	50.8 (40)	19 (16.4)	11 (9)	65	38 (30)	PNEJ1245N	PTKA0407F	TW15S
200-09R/L	18	200	9	53	90	50.8 (40)	19 (16.4)	11 (9)	65	38 (30)	PNEJ1250N	PTKA0408F	TW15S
200-10R/L	18	200	10	53	90	50.8 (40)	19 (16.4)	11 (9)	65	38 (30)	PNEJ1255N	PTKA0409F	TW15S
200-11R/L	18	200	11	53	90	50.8 (40)	19 (16.4)	11 (9)	65	38 (30)	PNEJ1260N	PTKA0410F	TW15S
200-12R/L	18	200	12	53	90	50.8 (40)	19 (16.4)	11 (9)	65	38 (30)	PNEJ1265N	PTKA0411F	TW15S
200-13R/L	18	200	13	53	90	50.8 (40)	19 (16.4)	11 (9)	65	38 (30)	PNEJ1270N	PTKA0412F	TW15S
200-14R/L	18	200	14	53	90	50.8 (40)	19 (16.4)	11 (9)	65	38 (30)	PNEJ1275N	PTKA0413F	TW15S

() Metric size

Notice (When mounting inserts)

- ▶ Insert chip breaker should face chip pocket of the cutter
- ▶ Fasten screw after insert contacts securely on its seat
- ▶ If there is a gap between insert and its seat after mounting it may cause tool troubles

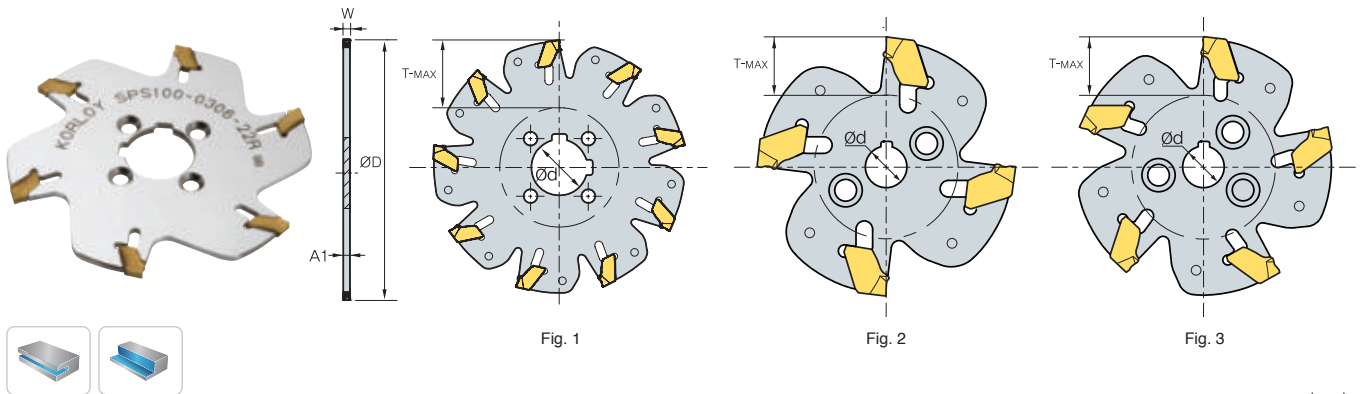
Recommended cutting condition

Workpiece	Cutting condition		Grades
	vc (m/min)	fz (mm/t)	
P	190~310	0.10~0.25	NCM325 PC3700 ST30A
	160~270	0.10~0.30	
	60~100	0.10~0.25	
M	90~150	0.10~0.25	PC9530 ST30A
	80~150	0.10~0.30	
K	140~230	0.10~0.35 0.10~0.40	PC6510 G10

Available inserts E16 Available arbors and bolt E426~E428



SPS

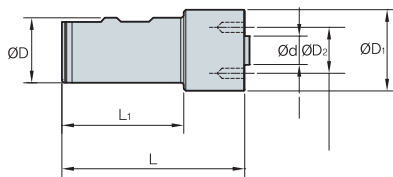


(mm)

Designation	⊙	ØD	W	T-MAX	Ød	A1	Fig.	Insert	Adaptor		Wrench	
									WS	DF		
SPS	050-0204-08R	4	50	2.2	11	8	1.8	SPFN 200 - ()	WS2528-M4	-	SW17P (separately ordered)	
	063-0205-10R	5	63	2.2	15.5	10	1.8		3	WS2532-M5		-
	080-0207-22R/F	7	80	2.2	20 (17)	22	1.8		1	WS3240-M5		DF22-46
	100-0209-22R/F	9	100	2.2	30 (27)	22	1.8		1	WS3240-M5		DF22-46
	125-0211-32F	11	125	2.2	35	32	1.8		1	-		DF32-55
	160-0214-32F	14	160	2.2	52.5	32	1.8	3	-	DF32-55		
	063-0305-10R	5	63	3	15.5	10	2.55	1	SPFN 300 - ()	WS2532-M5		-
	080-0307-22R/F	7	80	3	20 (17)	22	2.55	1		WS3240-M5		DF22-46
	100-0309-22R/F	9	100	3	30 (27)	22	2.55	1		WS3240-M5		DF22-46
	125-0311-32F	11	125	3	35	32	2.55	1		-		DF32-55
	160-0314-32F	14	160	3	52.5	32	2.55	1		-		DF32-55
	200-0318-40F	18	200	3	60	40	2.55	1	-	DF40-80		
	080-0406-22R/F	6	80	4	20 (17)	22	3.4	1	SPFN 400 - ()	WS3240-M5		DF22-46
	100-0408-22R/F	8	100	4	30 (27)	22	3.4	1		WS3240-M5		DF22-46
	125-0410-32F	10	125	4	35	32	3.4	1		-		DF32-55
	160-0413-32F	13	160	4	52.5	32	3.4	1		-		DF32-55
	200-0417-40F	17	200	4	60	40	3.4	1		-		DF40-80

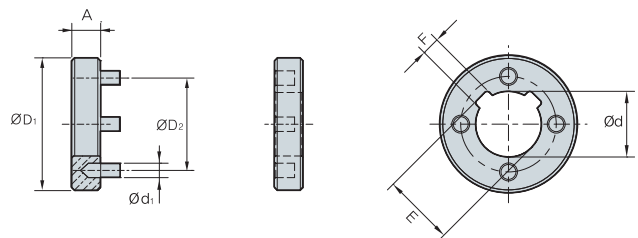
() Metric size

WS()-() (Weldon Shank)



Designation	L	L1	D	D1	D2	d	Screw
WS2528-M4	110	85	25	28	18	8	PTKA0408
WS2532-M5	110	85	25	32	22	10	PTKA0515
WS3240-M5	120	90	32	40	32	22	PTKA0515

DF()-() (Drive Flange set)



Designation	D1	D2	d	d1	A	E	F
DF22-46	46	32	22	5	10	24.1	6
DF32-55	55	45	32	6	10	34.8	8
DF40-80	80	63	40	11	12	43.5	10
DF50-110	110	80	50	14	14	53.6	12

Recommended cutting condition

Workpiece	Cutting condition		Grades
	vc (m/min)	fz (mm/t)	
P	160~270	0.13~0.25	PC3700
M	90~150	0.10~0.22	PC5300
K	110~180	0.10~0.25	PC6510

Available inserts E26 Available arbors and bolt E426~E428

E Technical Information for Wind Mill

For slotting workpieces with corner radii of varying sizes and widths

Wind Mill

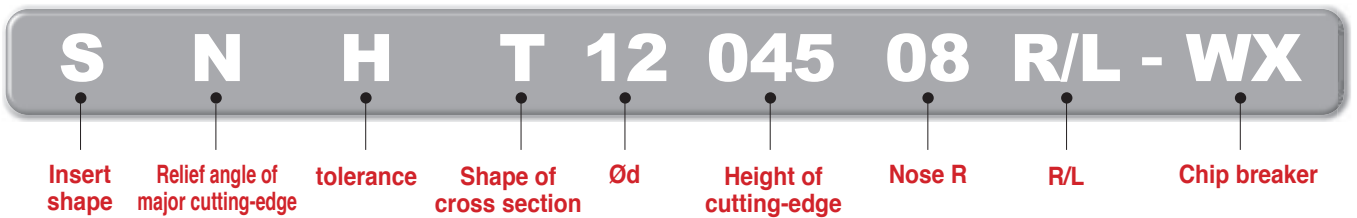
- Optimal machining for slotting applications
- A unique recess design on the minor cutting-edge reduces cutting load and improves tool life
- Special clamping system prevents incorrect clamping and fracture

Item description

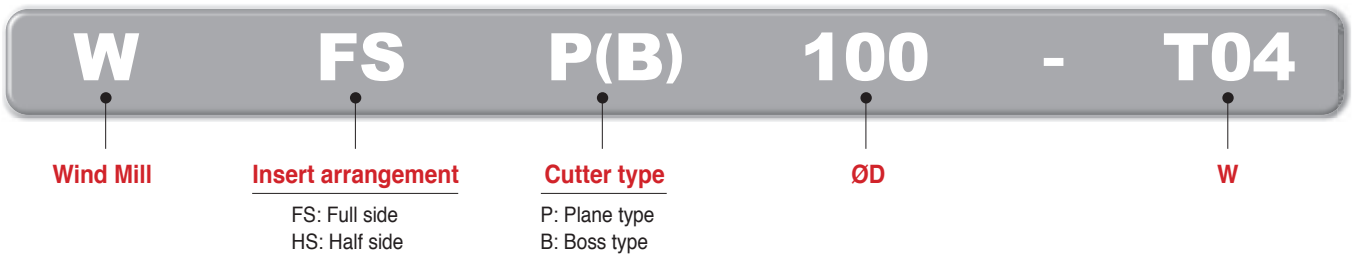


Code system

• Insert

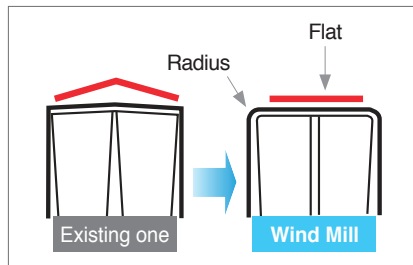


• Cutter

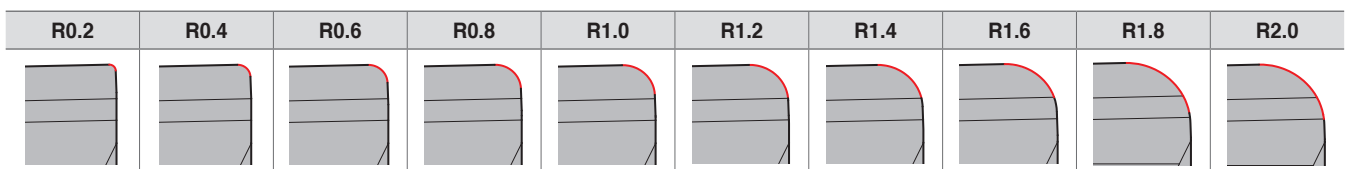


Features

- Ideal geometry for superior surface roughness and extended tool life
- Perpendicular slot
- Protruded part on tip seat prevents wrong clamping and fracture



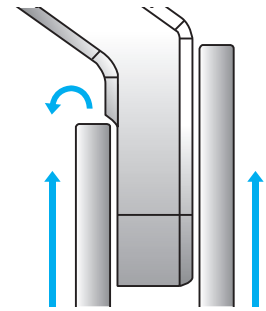
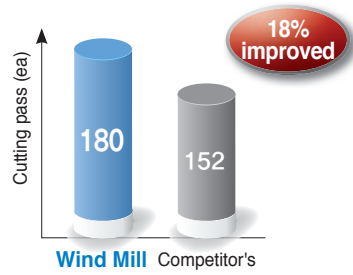
• Workpieces with corner radii of varying size and width (R0.2~R2.0)



Application example

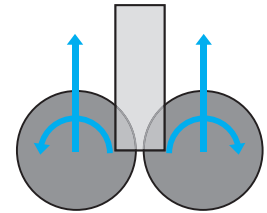
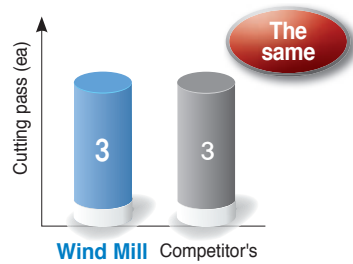
- **Use** Carriers for Motor Vehicles
- **Workpiece** FCD500K
- **Cutting conditions**
 - vc (m/min) = 200
 - fz (mm/t) = 0.2
 - vf (mm/min) = 600
 - ap (mm) = 2~3
- **Tool**
 - KSF140R-T14-HM-2
 - SNHT1205408R/L-WX (PC5300)

Test result



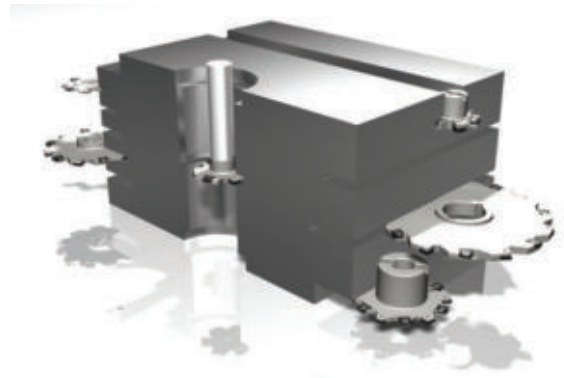
- **Use** Lug for Vessel
- **Workpiece** Mild steel
- **Cutting conditions**
 - vc (m/min) = 560
 - fz (mm/t) = 0.09
 - vf (mm/min) = 750
 - ap (mm) = 6
- **Tool**
 - WFSP178R/L-T06
 - SNHT1203508R/L-WX (PC5300)

Test result



Recommended cutting condition

Workpiece	Cutting conditions		Grades
	vc (m/min)	fz (mm/t)	
P	150~250	0.10~0.25	PC5300
M	120~200	0.10~0.30	PC5300
K	100~150	0.10~0.30	PC5300



Available inserts

Designation	Coated PC5300	Dimensions (mm)				Nose R	Configuration
		Ød	Ød ₁	t	W		
SNHT 1102308R/L-WX	●	11.0	4	2.30	4.0	0.2, 0.4, 0.6, 0.8, 1.0, 1.2, 1.4, 1.6	
110308R/L-WX	●	11.0	4	3.00	5.0	0.2, 0.4, 0.6, 0.8, 1.0, 1.2, 1.4, 1.6	
1203508R/L-WX	●	12.7	5	3.54	6.0	0.2, 0.4, 0.6, 0.8, 1.0, 1.2, 1.4, 1.6, 2.0	
120408R/L-WX		12.7	5	4.00	7.0	0.2, 0.4, 0.6, 0.8, 1.0, 1.2, 1.4, 1.6, 2.0	
1204508R/L-WX	●	12.7	5	4.54	8.0	0.2, 0.4, 0.6, 0.8, 1.0, 1.2, 1.4, 1.6, 2.0	
120508R/L-WX	●	12.7	5	5.00	9.0	0.2, 0.4, 0.6, 0.8, 1.0, 1.2, 1.4, 1.6, 2.0	
1205408R/L-WX	●	12.7	5	5.47	10.0	0.2, 0.4, 0.6, 0.8, 1.0, 1.2, 1.4, 1.6, 2.0	
120608R/L-WX		12.7	5	6.00	11.0	0.2, 0.4, 0.6, 0.8, 1.0, 1.2, 1.4, 1.6, 2.0	
1206508R/L-WX		12.7	5	6.50	12.0	0.2, 0.4, 0.6, 0.8, 1.0, 1.2, 1.4, 1.6, 2.0	
120708R/L-WX		12.7	5	7.00	13.0	0.2, 0.4, 0.6, 0.8, 1.0, 1.2, 1.4, 1.6, 2.0	
1207508R/L-WX		12.7	5	7.50	14.0	0.2, 0.4, 0.6, 0.8, 1.0, 1.2, 1.4, 1.6, 2.0	

• Available cutter stock requires to be asked separately

WFSB(M) (Boss type)

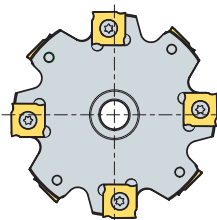
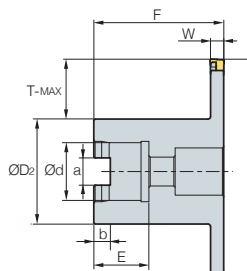


Fig. 1

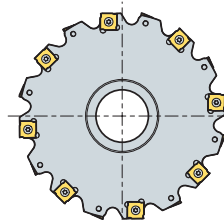
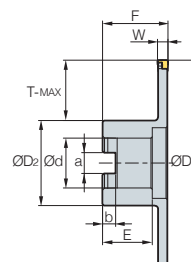


Fig. 2



- AR: -2°
- RR: -12°

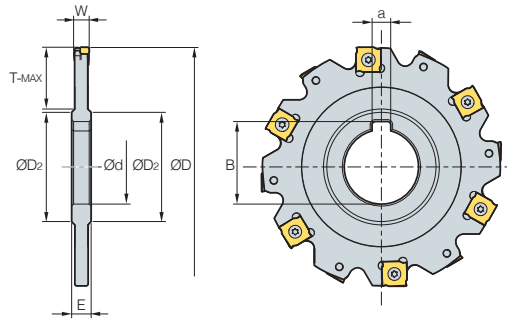
(mm)

Designation	ØD	W	T-MAX	ØD ₂	Ød	a	b	F	E	Insert	Screw	Wrench
WFSBM 080R/L-T04	8	80	4	17	40	22	10.4	6.3	50	21	SNHT11023R/L-WX	PTMA03503 TW09S
080R/L-T05	8	80	5	17	40	22	10.4	6.3	50	21	SNHT1103R/L-WX	PTMA03504 TW09S
080R/L-T06	8	80	6	17	40	22	10.4	6.3	50	21	SNHT12035R/L-WX	PTMA04045F TW15S
WFSB (WFSBM) 100R/L-T04	10	100	4	21	50 (48)	25.4 (27)	9.5 (12.4)	6 (7)	50	25	SNHT11023R/L-WX	PTMA03503 TW09S
100R/L-T05	10	100	5	21	50 (48)	25.4 (27)	9.5 (12.4)	6 (7)	50	25	SNHT1103R/L-WX	PTMA03504 TW09S
100R/L-T06	10	100	6	21	50 (48)	25.4 (27)	9.5 (12.4)	6 (7)	50	25	SNHT12035R/L-WX	PTMA04045F TW15S
100R/L-T07	10	100	7	21	50 (48)	25.4 (27)	9.5 (12.4)	6 (7)	50	25	SNHT1204R/L-WX	PTMA0405F TW15S
100R/L-T08	10	100	8	21	50 (48)	25.4 (27)	9.5 (12.4)	6 (7)	50	25	SNHT12045R/L-WX	PTMA0406F TW15S
100R/L-T09	10	100	9	21	50 (48)	25.4 (27)	9.5 (12.4)	6 (7)	50	25	SNHT1205R/L-WX	PTMA0407F TW15S
100R/L-T10	10	100	10	21	50 (48)	25.4 (27)	9.5 (12.4)	6 (7)	50	25	SNHT12054R/L-WX	PTMA0408F TW15S
125R/L-T04	12	125	4	30	60 (58)	31.75 (32)	12.7 (14.4)	8	50	32 (30)	SNHT11023R/L-WX	PTMA03503 TW09S
125R/L-T05	12	125	5	30	60 (58)	31.75 (32)	12.7 (14.4)	8	50	32 (30)	SNHT1103R/L-WX	PTMA03504 TW09S
125R/L-T06	12	125	6	30	60 (58)	31.75 (32)	12.7 (14.4)	8	50	32 (30)	SNHT12035R/L-WX	PTMA04045F TW15S
125R/L-T07	12	125	7	30	60 (58)	31.75 (32)	12.7 (14.4)	8	50	32 (30)	SNHT1204R/L-WX	PTMA0405F TW15S
125R/L-T08	12	125	8	30	60 (58)	31.75 (32)	12.7 (14.4)	8	50	32 (30)	SNHT12045R/L-WX	PTMA0406F TW15S
125R/L-T09	12	125	9	30	60 (58)	31.75 (32)	12.7 (14.4)	8	50	32 (30)	SNHT1205R/L-WX	PTMA0407F TW15S
125R/L-T10	12	125	10	30	60 (58)	31.75 (32)	12.7 (14.4)	8	50	32 (30)	SNHT12054R/L-WX	PTMA0408F TW15S
160R/L-T04	16	160	4	43	70	38.1 (40)	15.9 (16.4)	10 (9)	60	38 (32)	SNHT11023R/L-WX	PTMA03503 TW09S
160R/L-T05	16	160	5	43	70	38.1 (40)	15.9 (16.4)	10 (9)	60	38 (32)	SNHT1103R/L-WX	PTMA03504 TW09S
160R/L-T06	16	160	6	43	70	38.1 (40)	15.9 (16.4)	10 (9)	60	38 (32)	SNHT12035R/L-WX	PTMA04045F TW15S
160R/L-T07	16	160	7	43	70	38.1 (40)	15.9 (16.4)	10 (9)	60	38 (32)	SNHT1204R/L-WX	PTMA0405F TW15S
160R/L-T08	16	160	8	43	70	38.1 (40)	15.9 (16.4)	10 (9)	60	38 (32)	SNHT12045R/L-WX	PTMA0406F TW15S
160R/L-T09	16	160	9	43	70	38.1 (40)	15.9 (16.4)	10 (9)	60	38 (32)	SNHT1205R/L-WX	PTMA0407F TW15S
160R/L-T10	16	160	10	43	70	38.1 (40)	15.9 (16.4)	10 (9)	60	38 (32)	SNHT12054R/L-WX	PTMA0408F TW15S
160R/L-T11	16	160	11	43	70	38.1 (40)	15.9 (16.4)	10 (9)	60	38 (32)	SNHT1206R/L-WX	PTKA0409F TW15S
160R/L-T12	16	160	12	43	70	38.1 (40)	15.9 (16.4)	10 (9)	60	38 (32)	SNHT12065R/L-WX	PTKA0410F TW15S
160R/L-T13	16	160	13	43	70	38.1 (40)	15.9 (16.4)	10 (9)	60	38 (32)	SNHT1207R/L-WX	PTKA0411F TW15S
160R/L-T14	16	160	14	43	70	38.1 (40)	15.9 (16.4)	10 (9)	60	38 (32)	SNHT12075R/L-WX	PTKA0412F TW15S
200R/L-T06	18	200	6	53	90	50.8 (40)	19.1 (16.4)	11 (9)	65	38 (32)	SNHT12035R/L-WX	PTMA04045F TW15S
200R/L-T07	18	200	7	53	90	50.8 (40)	19.1 (16.4)	11 (9)	65	38 (32)	SNHT1204R/L-WX	PTMA0405F TW15S
200R/L-T08	18	200	8	53	90	50.8 (40)	19.1 (16.4)	11 (9)	65	38 (32)	SNHT12045R/L-WX	PTMA0406F TW15S
200R/L-T09	18	200	9	53	90	50.8 (40)	19.1 (16.4)	11 (9)	65	38 (32)	SNHT1205R/L-WX	PTMA0407F TW15S
200R/L-T10	18	200	10	53	90	50.8 (40)	19.1 (16.4)	11 (9)	65	38 (32)	SNHT12054R/L-WX	PTMA0408F TW15S
200R/L-T11	18	200	11	53	90	50.8 (40)	19.1 (16.4)	11 (9)	65	38 (32)	SNHT1206R/L-WX	PTKA0409F TW15S
200R/L-T12	18	200	12	53	90	50.8 (40)	19.1 (16.4)	11 (9)	65	38 (32)	SNHT12065R/L-WX	PTKA0410F TW15S
200R/L-T13	18	200	13	53	90	50.8 (40)	19.1 (16.4)	11 (9)	65	38 (32)	SNHT1207R/L-WX	PTKA0411F TW15S
200R/L-T14	18	200	14	53	90	50.8 (40)	19.1 (16.4)	11 (9)	65	38 (32)	SNHT12075R/L-WX	PTKA0412F TW15S
250R/L-T06	20	250	6	73 (78)	100 (90)	50.8 (40)	19.1 (16.4)	11 (9)	65	38 (32)	SNHT12035R/L-WX	PTMA04045F TW15S
250R/L-T07	20	250	7	73 (78)	100 (90)	50.8 (40)	19.1 (16.4)	11 (9)	65	38 (32)	SNHT1204R/L-WX	PTMA0405F TW15S
250R/L-T08	20	250	8	73 (78)	100 (90)	50.8 (40)	19.1 (16.4)	11 (9)	65	38 (32)	SNHT12045R/L-WX	PTMA0406F TW15S
250R/L-T09	20	250	9	73 (78)	100 (90)	50.8 (40)	19.1 (16.4)	11 (9)	65	38 (32)	SNHT1205R/L-WX	PTMA0407F TW15S
250R/L-T10	20	250	10	73 (78)	100 (90)	50.8 (40)	19.1 (16.4)	11 (9)	65	38 (32)	SNHT12054R/L-WX	PTMA0408F TW15S
250R/L-T11	20	250	11	73 (78)	100 (90)	50.8 (40)	19.1 (16.4)	11 (9)	65	38 (32)	SNHT1206R/L-WX	PTKA0409F TW15S
250R/L-T12	20	250	12	73 (78)	100 (90)	50.8 (40)	19.1 (16.4)	11 (9)	65	38 (32)	SNHT12065R/L-WX	PTKA0410F TW15S
250R/L-T13	20	250	13	73 (78)	100 (90)	50.8 (40)	19.1 (16.4)	11 (9)	65	38 (32)	SNHT1207R/L-WX	PTKA0411F TW15S
250R/L-T14	20	250	14	73 (78)	100 (90)	50.8 (40)	19.1 (16.4)	11 (9)	65	38 (32)	SNHT12075R/L-WX	PTKA0412F TW15S

• Ø80: Fig.1, Ø100~Ø250: Fig.2 ()Metric size Available inserts E25



WFSP(M) (Plane type)



- AR: -2°
- RR: -12°

(mm)

Designation		ØD	W	T-MAX	ØD ₂	Ød	a	b	E	Insert	Screw	Wrench
WFSP (WFSBM)	080-T04	8	80	4	20	40	25.4 (27)	6.35 (7)	28 (29.8)	8	SNHT11023R/L-WX	PTMA03503 TW09S
	080-T05	8	80	5	20	40	25.4 (27)	6.35 (7)	28 (29.8)	8	SNHT1103R/L-WX	PTMA03504 TW09S
	080-T06	8	80	6	20	40	25.4 (27)	6.35 (7)	28 (29.8)	8	SNHT12035R/L-WX	PTMA04045F TW15S
	100-T04	10	100	4	24	47	31.75 (32)	7.92 (8)	35.2 (34.8)	8	SNHT11023R/L-WX	PTMA03503 TW09S
	100-T05	10	100	5	24	47	31.75 (32)	7.92 (8)	35.2 (34.8)	8	SNHT1103R/L-WX	PTMA03504 TW09S
	100-T06	10	100	6	24	47	31.75 (32)	7.92 (8)	35.2 (34.8)	8	SNHT12035R/L-WX	PTMA04045F TW15S
	100-T07	10	100	7	24	47	31.75 (32)	7.92 (8)	35.2 (34.8)	10	SNHT1204R/L-WX	PTMA0405F TW15S
	100-T08	10	100	8	24	47	31.75 (32)	7.92 (8)	35.2 (34.8)	10	SNHT12045R/L-WX	PTMA0406F TW15S
	100-T09	10	100	9	24	47	31.75 (32)	7.92 (8)	35.2 (34.8)	12	SNHT1205R/L-WX	PTMA0407F TW15S
	100-T10	10	100	10	24	47	31.75 (32)	7.92 (8)	35.2 (34.8)	12	SNHT12054R/L-WX	PTMA0408F TW15S
125-T04	12	125	4	32	56	38.1 (40)	9.52 (10)	42.3 (43.5)	8	SNHT11023R/L-WX	PTMA03503 TW09S	
125-T05	12	125	5	32	56	38.1 (40)	9.52 (10)	42.3 (43.5)	8	SNHT1103R/L-WX	PTMA03504 TW09S	
125-T06	12	125	6	32	56	38.1 (40)	9.52 (10)	42.3 (43.5)	8	SNHT12035R/L-WX	PTMA04045F TW15S	
125-T07	12	125	7	32	56	38.1 (40)	9.52 (10)	42.3 (43.5)	10	SNHT1204R/L-WX	PTMA0405F TW15S	
125-T08	12	125	8	32	56	38.1 (40)	9.52 (10)	42.3 (43.5)	10	SNHT12045R/L-WX	PTMA0406F TW15S	
125-T09	12	125	9	32	56	38.1 (40)	9.52 (10)	42.3 (43.5)	12	SNHT1205R/L-WX	PTMA0407F TW15S	
125-T10	12	125	10	32	56	38.1 (40)	9.52 (10)	42.3 (43.5)	12	SNHT12054R/L-WX	PTMA0408F TW15S	
160-T04	16	160	4	45	66	38.1 (40)	9.52 (10)	42.3 (43.5)	8	SNHT11023R/L-WX	PTMA03503 TW09S	
160-T05	16	160	5	45	66	38.1 (40)	9.52 (10)	42.3 (43.5)	8	SNHT1103R/L-WX	PTMA03504 TW09S	
160-T06	16	160	6	45	66	38.1 (40)	9.52 (10)	42.3 (43.5)	8	SNHT12035R/L-WX	PTMA04045F TW15S	
160-T07	16	160	7	45	66	38.1 (40)	9.52 (10)	42.3 (43.5)	10	SNHT1204R/L-WX	PTMA0405F TW15S	
160-T08	16	160	8	45	66	38.1 (40)	9.52 (10)	42.3 (43.5)	10	SNHT12045R/L-WX	PTMA0406F TW15S	
160-T09	16	160	9	45	66	38.1 (40)	9.52 (10)	42.3 (43.5)	12	SNHT1205R/L-WX	PTMA0407F TW15S	
160-T10	16	160	10	45	66	38.1 (40)	9.52 (10)	42.3 (43.5)	12	SNHT12054R/L-WX	PTMA0408F TW15S	
160-T11	16	160	11	45	66	38.1 (40)	9.52 (10)	42.3 (43.5)	14	SNHT1206R/L-WX	PTKA0409F TW15S	
160-T12	16	160	12	45	66	38.1 (40)	9.52 (10)	42.3 (43.5)	14	SNHT12065R/L-WX	PTKA0410F TW15S	
160-T13	16	160	13	45	66	38.1 (40)	9.52 (10)	42.3 (43.5)	16	SNHT1207R/L-WX	PTKA0411F TW15S	
160-T14	16	160	14	45	66	38.1 (40)	9.52 (10)	42.3 (43.5)	16	SNHT12075R/L-WX	PTKA0412F TW15S	
200-T06	18	200	6	60	70	50.8 (50)	12.7 (12)	55.8 (53.5)	8	SNHT12035R/L-WX	PTMA04045F TW15S	
200-T07	18	200	7	60	70	50.8 (50)	12.7 (12)	55.8 (53.5)	10	SNHT1204R/L-WX	PTMA0405F TW15S	
200-T08	18	200	8	60	70	50.8 (50)	12.7 (12)	55.8 (53.5)	10	SNHT12045R/L-WX	PTMA0406F TW15S	
200-T09	18	200	9	60	70	50.8 (50)	12.7 (12)	55.8 (53.5)	12	SNHT1205R/L-WX	PTMA0407F TW15S	
200-T10	18	200	10	60	70	50.8 (50)	12.7 (12)	55.8 (53.5)	12	SNHT12054R/L-WX	PTMA0408F TW15S	
200-T11	18	200	11	60	70	50.8 (50)	12.7 (12)	55.8 (53.5)	14	SNHT1206R/L-WX	PTKA0409F TW15S	
200-T12	18	200	12	60	70	50.8 (50)	12.7 (12)	55.8 (53.5)	14	SNHT12065R/L-WX	PTKA0410F TW15S	
200-T13	18	200	13	60	70	50.8 (50)	12.7 (12)	55.8 (53.5)	16	SNHT1207R/L-WX	PTKA0411F TW15S	
200-T14	18	200	14	60	70	50.8 (50)	12.7 (12)	55.8 (53.5)	16	SNHT12075R/L-WX	PTKA0412F TW15S	
250-T06	20	250	6	88	70	50.8 (50)	12.7 (12)	55.8 (53.5)	8	SNHT12035R/L-WX	PTMA04045F TW15S	
250-T07	20	250	7	88	70	50.8 (50)	12.7 (12)	55.8 (53.5)	10	SNHT1204R/L-WX	PTMA0405F TW15S	
250-T08	20	250	8	88	70	50.8 (50)	12.7 (12)	55.8 (53.5)	10	SNHT12045R/L-WX	PTMA0406F TW15S	
250-T09	20	250	9	88	70	50.8 (50)	12.7 (12)	55.8 (53.5)	12	SNHT1205R/L-WX	PTMA0407F TW15S	
250-T10	20	250	10	88	70	50.8 (50)	12.7 (12)	55.8 (53.5)	12	SNHT12054R/L-WX	PTMA0408F TW15S	
250-T11	20	250	11	88	70	50.8 (50)	12.7 (12)	55.8 (53.5)	14	SNHT1206R/L-WX	PTKA0409F TW15S	
250-T12	20	250	12	88	70	50.8 (50)	12.7 (12)	55.8 (53.5)	14	SNHT12065R/L-WX	PTKA0410F TW15S	
250-T13	20	250	13	88	70	50.8 (50)	12.7 (12)	55.8 (53.5)	16	SNHT1207R/L-WX	PTKA0411F TW15S	
250-T14	20	250	14	88	70	50.8 (50)	12.7 (12)	55.8 (53.5)	16	SNHT12075R/L-WX	PTKA0412F TW15S	

Available inserts E25

• Ø80: Fig.1 , Ø100~Ø250: Fig.2 ()Metric size



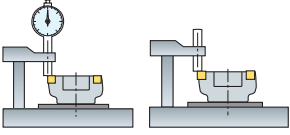
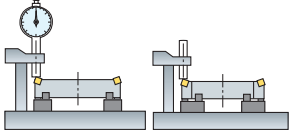
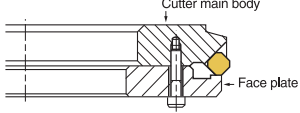
High feed cutter with extra pitch for cast iron and light alloy steels

High feed Cutter

- High feed cutter employs extra pitch for cast iron and light alloy steels
- Quick change type for reduction of cutter change time
- Cutting-edge chatter is controlled
- Quick change type for cutter size under $\phi 160$, 2 piece types for cutter size over $\phi 200$

Guide of insert setting

- Special equipment has to be used to get precise run out with high feed cutter.

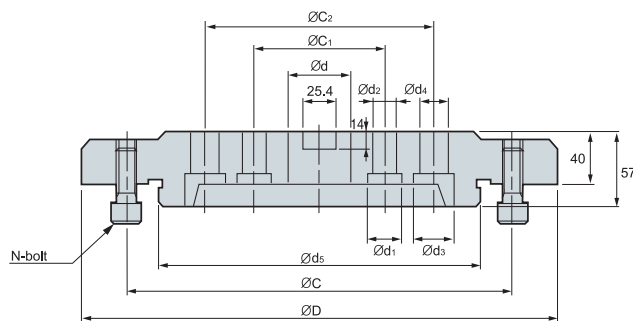
Adaptor type	Roller type	Plate type
		
<ul style="list-style-type: none"> - Mainly under $\phi 160$ diameter is used in 1 piece type - Available for fixed size of cutter and assembling & checking can be done at the same time 	<ul style="list-style-type: none"> - Mainly over $\phi 200$ diameter is used in 2 piece type - Due to 3 adjustable guide rollers, variety size of cutter can be assembled 	<ul style="list-style-type: none"> - Suitable for small size cutter due to the simple structure - It is unnecessary to unclamp the cutter from the machine, it's possible to reassemble the cutter as it mounted on the machine - You should make plate by yourself

Guide of insert setting in adaptor/roller type

1. Clean the cutter and equipment
2. Pointer should be assembled with same height with cutter
3. Move to each insert on tip seat to end of pointer and tighten (torque 2 N.m) wedge
4. Exchange pointer to dial gauge
5. Measure the run-out totally
6. When a insert over run-out, loosen wedge and adjust run-out. (for roughing 10~20 μ , for finishing 5~10 μ)
7. Tighten (torque 7-8 N.m) wedge
8. Measure the final run-out by dial gauge

Note: When you clamp wedge too tightly, run-out will get worse due to cutter distortion.
When you clamp the wedge, use torque wrench to set precisely.

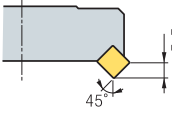
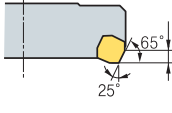
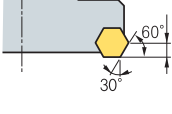
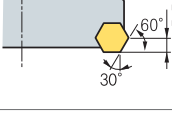


Adaptor ($\phi 200 \sim \phi 450$)



Designation	ϕD	ϕd	ϕd_1	ϕd_2	ϕd_3	ϕd_4	ϕd_5	ϕC	ϕC_1	ϕC_2	N	Cutter
APR 200	180	47.625	26	18	-	-	80	120	101.6	-	4	$\phi 200$
250	230	47.625	26	18	-	-	120	170	101.6	-	4	$\phi 250$
315	295	47.625	26	18	32	22	180	230	101.6	177.8	6	$\phi 315$
355	335	63.50	26	18	32	22	220	270	101.6	177.8	6	$\phi 355$
400	370	63.50	26	18	32	22	250	300	101.6	177.8	8	$\phi 400$
450	420	63.50	26	18	32	22	300	350	101.6	177.8	8	$\phi 450$



High feed cutters type and features

Designation	Cutter diameter	Workpiece, Application range	Min. surface roughness	Approach angle and Max. cutting depth is for 5000 type	Axial rake angle	Radial rake angle	Available insert
ANH4000 ANH5000	Ø100~Ø450	Cast iron Roughing	25Z		-5°	-6°	SNCN1204ENN SNCN1504ENN
CDH4000 CDH5000	Ø100~Ø450	Cast iron Roughing Finishing	18Z		+10°	+5°	SDCN42R SDCN53R
DEH5000	Ø100~Ø450	Al alloy Roughing	20Z		+14°	+6°	HECN090408FN
DPH5000	Ø100~Ø450	Cast iron Roughing Finishing	12Z		+5°	-3°	HPEN090408 HPEN090408-WC
PNH4000 PNH5000	Ø125~Ø450	Cast iron Finishing	12Z		-5°	-6°	SNEF435 SNEF535
PPH4000	Ø125~Ø450	Cast iron Finishing	12Z		+5°	-5°	SPEN120416-WC

Recommended cutting condition

Workpiece	Cutting condition		Grades	Remark
	vc (m/min)	fz (mm/t)		
Cast iron	100~230	0.05~0.20	PC6510	PVD Coated
	80~150	0.05~0.20	H01, G10	Uncoated
Al alloy	400	0.10~0.30	PC6510	PVD Coated
	400	0.05~0.20	H01, G10	Uncoated

E Technical Information for Cube Mill

Special Korloy cutter for cast iron roughing

Cube Mill

- Special Korloy cutter for cast iron roughing
- 8-corner using insert (maximum 16-corner available with 2 cutter, R/L cutter)
- Excellent cutting performance with positive rake angle made by 3-dimensional chip breaker
- Excellent tool life by a wide combination of grade varieties and chip breakers to match most working conditions
- 2 different type of inserts (chamfer/nose R) are available with 1 type cutter



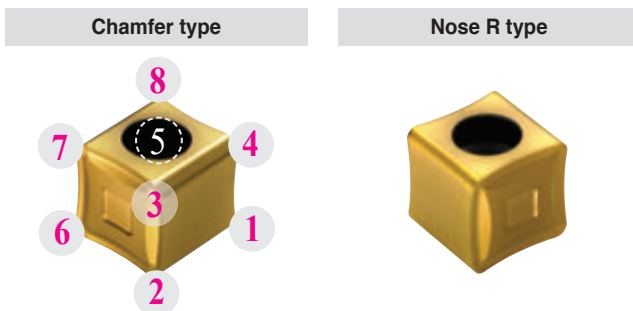
Roughing for cast iron

Code system

CBM	E	3	250	R	(2)	- 28Z
Cutter	AA	Inscribed circle of Insert	Cutter Dia	Hand	Cutter shape	No. of tooth (Z)
CBM: CUBE MILL	Q: 88° C: 65° F: 85° A: 45° E: 75°	3: 9.525 4: 12.7	Ø250	R: Right L: Left	Unmarked: Normal type 2: Quick change type (2 pieces type)	

※ Cube Mill and Cube Mill Couple are available by order made.

Insert (R/L type)



Cutter body

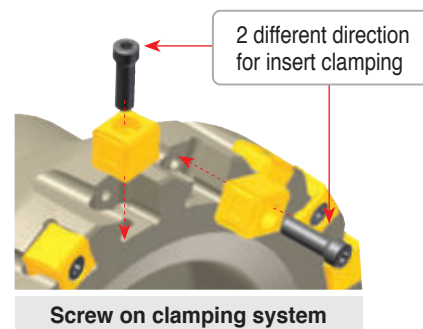
Cutter diameter (Ø)	Normal	Quick change
	Ø80~315 mm 3 1/4~12 1/2 Inch	Ø200~450 mm 8~18 Inch
AA: 88°, 85°, 75°, 65°, 45°		

Cutter



Special design to make actual positive rake angle

Simple screw on system



Parts

<p>Cube Mill 3000</p>	<p>Screw</p>	<p>Wrench</p>
	FTGA0417CBM	TW15-100
	ETGA0520CBM	TW20-100



Ideal combination of aluminum body with cast iron high feed cutter

Couple Mill

- Ideal combination of Aluminum body with cast iron high feed cutter
- Since the weight of the cutter has been reduced 50% vs. a steel cutter, it is very easy to handle and very effective in preventing loading accidents
- Applicable for Cube Mill, Storm Mill

Code system

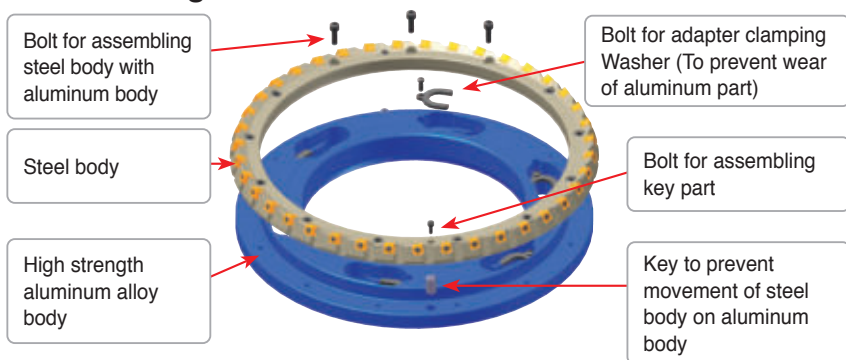
• Cube-couple

CBM	E	3	355	R	28Z	- CP
Cutter	AA	Inscribed circle of Insert	Cutter Dia	Hand	No. of tooth (Z)	Couple Mill
CBM: Cube Mill	Q: 88° C: 65° F: 85° A: 45° E: 75°	3: 9.525 4: 12.7	Ø355	R: Right L: Left	28Z: 28	

• Storm-couple

S	Q	N	3	355	R	28Z	- CP
Cutter	AA	Relief angle of insert	Inscribed circle of Insert	Cutter Dia	Hand	No. of tooth (Z)	Couple Mill
S: Storm Mill	Q: 88° E: 75° F: 85° A: 45°	N: Negative (0°)	3: 9.525 4: 12.7	Ø355	R: Right L: Left	28Z: 28	

Assembling structure



Cutter body

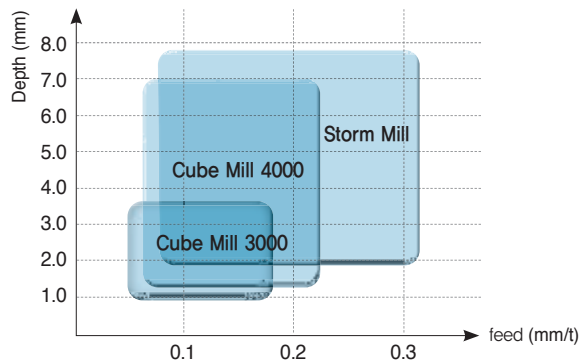
Cutter diameter (Ø)	Quick change	
	Metric	Ø355~450 mm
Inch	14 1/4~18 Inch	

Parts

Cube-Couple 3000 type	FTGA0417CBM	TW15-100	-	BHA0616	MHBO410	PN1019-DRV
Cube-Couple 4000 type	ETGA0520CBM	TW20-100	-	BHA0620	-	-
Storm-Couple 3000 type	FTNA0513	-	TW15S	-	-	-

E Technical Information for Couple Mill

Application range of high feed cutters for cast iron



Recommended cutting condition

Cube Mill		Gray cast iron		Ductile cast iron	
		vc (m/min)	fz (mm/t)	vc (m/min)	fz (mm/t)
PVD	PC6510	150~300	0.08~0.18	100~200	0.08~0.18
Uncoated	G10	90~120	0.05~0.18	60~130	0.05~0.18

Available arbors and adaptors

Designation	Available arbors and adaptors		
	Arbors	General arbor	Adaptor
CBMQ 3080R/L-00Z	BT□□-FMA25.4-□□	NT*□□(M/U)-FMA25.4-25	
(CBMF) 3100R/L-00Z	BT□□-FMA31.75-□□	NT*□□(M/U)-FMA31.75-□□	
(CBME) 3125R/L-00Z	BT□□-FMA38.1-□□	NT*□□(M/U)-FMA38.1-□□	
(CBMC) 3160R/L-00Z	BT□□-FMA50.8-□□	NT*□□(M/U)-FMA50.8-□□	
(CBMA) 3200R/L-00Z	BT□□-FMA47.625-□□	NT*□□(M/U)-FMA47.625-25, KCP-8***	
3250R/L-00Z	BT□□-FMA47.625-□□	KNT*□□(M/U)-FMA47.625-25, KCP-8***	
3315R/L-00Z		KCP-8*** (Centering Plug)	
3200R/L2-00Z			APR200
3250R/L2-00Z			APR250
3315R/L2-00Z			APR315
3355R/L2-00Z			APR355
3400R/L2-00Z			APR400
3450R/L2-00Z			APR450
SQN 3080R/L-00Z	BT□□-FMA25.4-□□	NT*□□(M/U)-FMA25.4-25	
(SFN) 3100R/L-00Z	BT□□-FMA31.75-□□	NT*□□(M/U)-FMA31.75-□□	
(SEN) 3125R/L-00Z	BT□□-FMA38.1-□□	NT*□□(M/U)-FMA38.1-□□	
(SAN) 3160R/L-00Z	BT□□-FMA50.8-□□	NT*□□(M/U)-FMA50.8-□□	
3200R/L-00Z	BT□□-FMA47.625-□□	NT*□□(M/U)-FMA47.625-25, KCP-8***	
3250R/L-00Z	BT□□-FMA47.625-□□	NT*□□(M/U)-FMA47.625-25, KCP-8***	
3315R/L-00Z		KCP-8*** (Centering Plug)	
3200R/L2-00Z			APR200
3250R/L2-00Z			APR250
3315R/L2-00Z			APR315
3355R/L2-00Z			APR355
3400R/L2-00Z			APR400
3450R/L2-00Z			APR450

*□□-NT number / **□□-BT number / ***Milling over 5
 <Arbors **add>
 ex) BT**□□



Optimal cutter for steel and cast iron machining with easily adjustable run-out

Shave Mill

- Adjustable Range (Adjustable range: 0.1 mm, Adjustable allowance: within 2 μm)
- Wiper crown type 8-cornered insert reduces machining cost and realizes excellent surface roughness
- Grades with high toughness and wear resistance ensures long tool life
- The cBN grade achieves superior surface finish

Code system

• Insert

■ Carbide

Nose R type	SNEU120420-MF
Chamfer type	SNEU1204ANN-MF
Low cutting type	SNEU1204-WMF

■ cBN

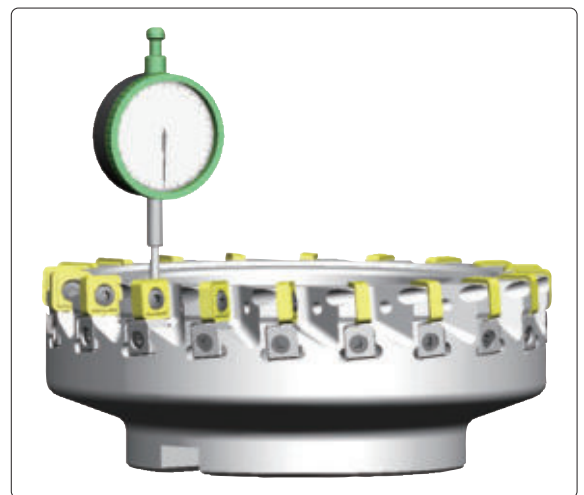
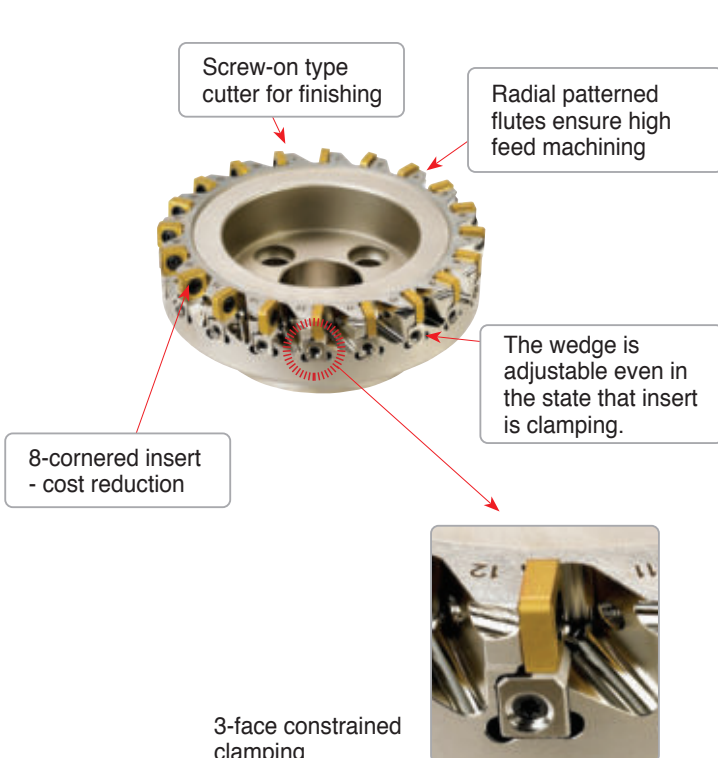
SNEU1204-TBW

T: Nagaland
B: cBN
W: Wiper

• Cutter

SVM	M	4	250	R	Z6
Shave Mill	Metric type M: Metric A: Inch	Inscribed Circle 4: 12.7 mm	Cutter Dia. (Ø) Ø250	Hand of tool R: Right handed L: Left handed	No. of tooth (Z)

Features

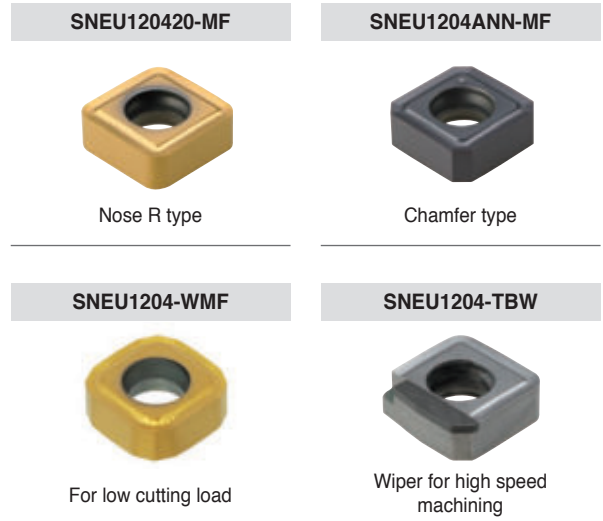
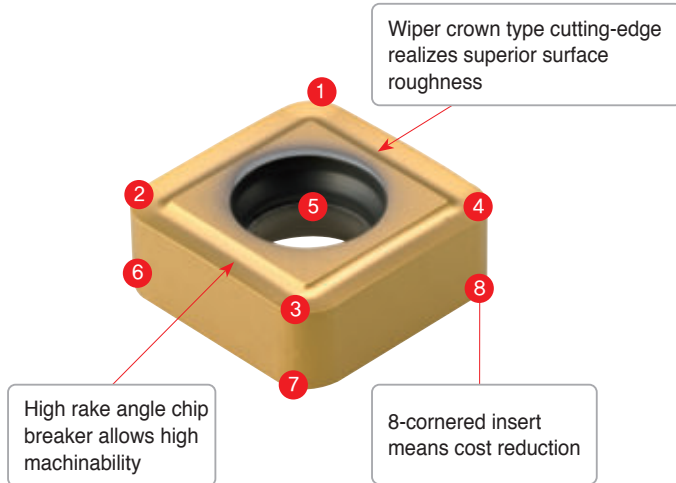


Adjustment

- Adjustable range: 0.1 mm
- Adjustability: below 2 μ
- Operation: easy and simple

E Technical Information for Shave Mill

Features of insert



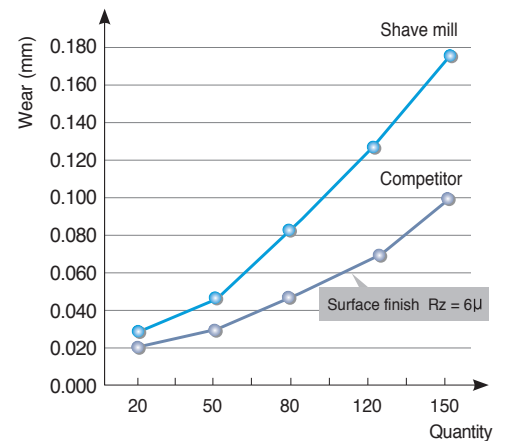
Recommended cutting condition

Workpiece	Cutting condition			Grades
	vc (m/min)	fz (mm/t)	ap (mm)	
P	160~270	0.05~0.2	~0.5	PC3700
K	140~230 600~1000	0.05~0.3 0.05~0.2	~0.5 ~0.5	PC6510 DBN920

Application example

- Workpiece: Cylinder head (facing)
- Cutting conditions: vc = 200, fz = 0.15, ap = 0.5, dry
- Tools: Cutter SVMM4250R
Insert PC6510 SNEU120420-MF

- Workpiece: FC25 (HB250) Cylinder head (facing)
- Cutting conditions: vc = 700, fz = 0.1, ap = 0.5, dry
- Tools: Cutter SVMM4160R
Insert DBN920 SNEU1204-cBN



Results

	Tool life	Surface finish	Machinability
Shave Mill	250 pcs	Rz = 3μ	High
Competitor	180 pcs	Rz = 3.5μ	Normal

KORLOY's Shave Mills ensure twice the machinability, adjustability, and surface roughness than competitor's, along with twice the tool life.



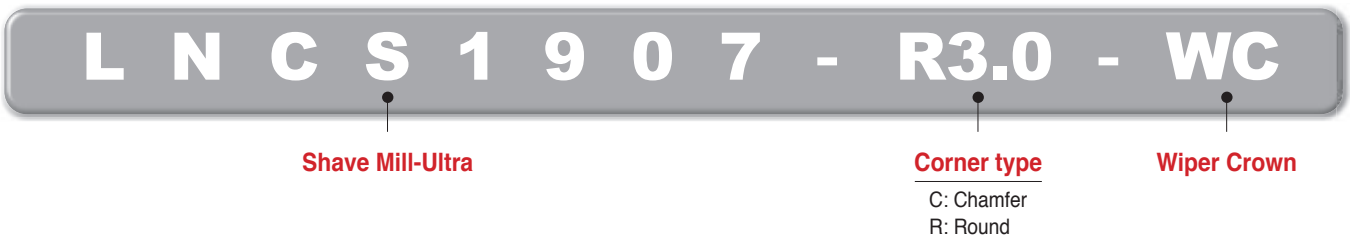
Better tool life with special grade which has both toughness and wear resistance

Shave Mill-Ultra

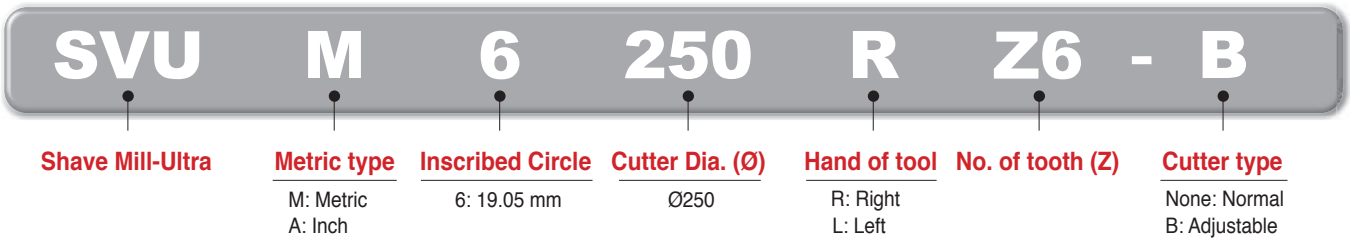
- Superior surface roughness for this Finishing cutter when applied to heavy work pieces
- Easy to handle and good rigidity with simple screw on system
- Superior surface finishes due to the wiper crown cutting-edge
- Better tool life with special grade which has both toughness and wear resistance
- Two different types: economical normal type and adjustable run-out type 'B'

Code system

• Insert




• Cutter

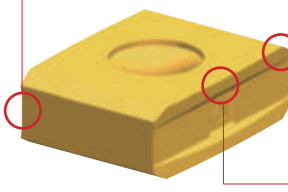


Features

Normal type




- Good rigidity and economical due to simple screw on type
- Better surface roughness when you use only 1 insert but adjust the 'ap' under 0.03 mm



- Good cutting performance & chip flow due to positive rake angle chip breaker
- Economical 4 corner insert
- Good surface roughness by wiper crown cutting-edge design

Adjustable cutting-edge (Type B)



- Easy to handle the run-out due to Korloy exclusive high toughness cutting-edge special parts

Adjustable Range

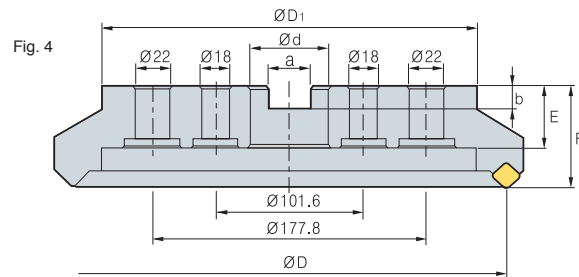
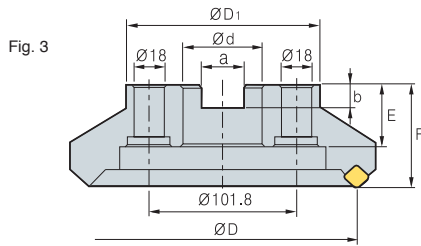
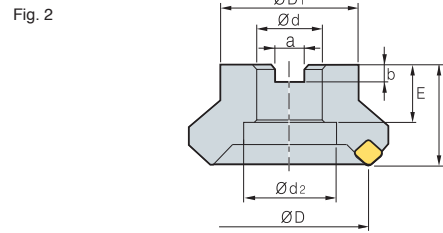
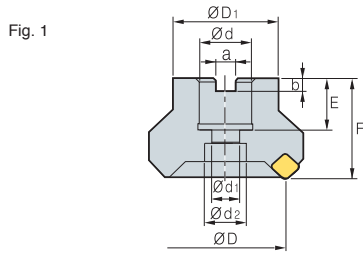
- Range: 1.0 mm
- Allowance: Within 2 μ

Recommended cutting condition

Workpiece	Cutting condition			Tooth	Grades
	vc (m/min)	fz (mm/t)	ap (mm)		
P	160~270	0.05~0.20	~0.50	Full use	PC3700
	160~270	2~5	~0.03	1 use	
k	140~230	0.05~0.20	~0.50	Full use	PC6510
	140~230	2~5	~0.03	1 use	

Inch

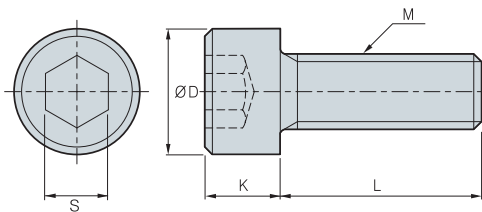
Actual designations of milling cutter



Inch type

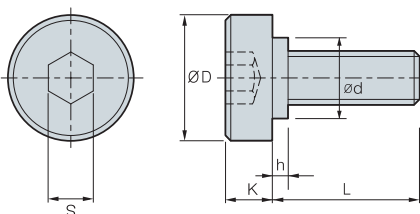
ØD	Ød	Dimensions (mm)				Fig.	Available arbors			
		a	b	E	F					
40	16	8.4	5.6	18	40	34	9	14	1	FMC16, SMA16
50	22	10.4	6.3	20	40	42	11	18	1	FMC22
63	22	10.4	6.3	20	40	49	11	18	1	FMC22
80	25.4	9.5	6	25	50	57	14	20	1	FMA25.4
100	31.75	12.7	8	32	50	67	-	45	2	FMA31.75, SMB31.75
125	38.1	15.9	10	38	63	87	-	56	2	FMA38.1
160	50.8	19	11	38	63	107	-	-	2	FMA50.8
200	47.625	25.4	14	38	63	130	-	-	3	FMA47.625
250	47.625	25.4	14	38	63	180	-	-	3	FMA47.625
315	47.625	25.4	14	38	63	240	-	-	4	-

Wrench bolt



Designation	ØD	S	K	L	M	Cutter size
SB0825	13	6	8	25	M08x1.25	Ø40
SB1025	16	8	10	25	M10x1.50	Ø50, Ø63
SB1035	16	8	10	35	M10x1.50	Ø50, Ø63 (HRM)
SB1230	18	10	12	30	M12x1.75	Ø80
SB1630	24	14	16	30	M16x2.0	Ø100
SB1645	24	14	16	45	M16x2.0	Ø80, Ø100 (HRM)
SB2040	30	17	20	40	M20x2.5	Ø125

Clamp bolt

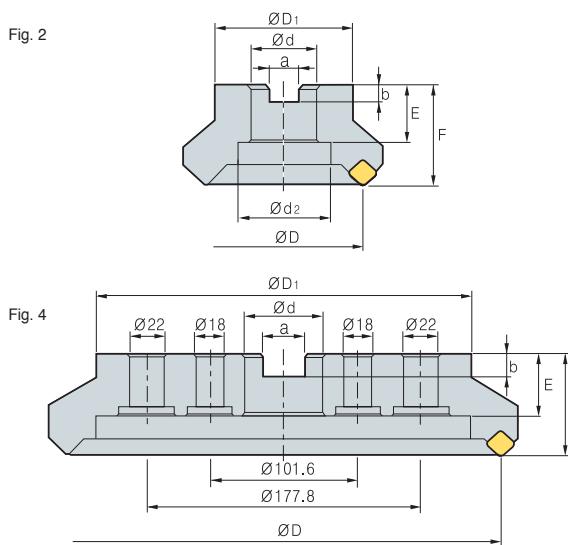
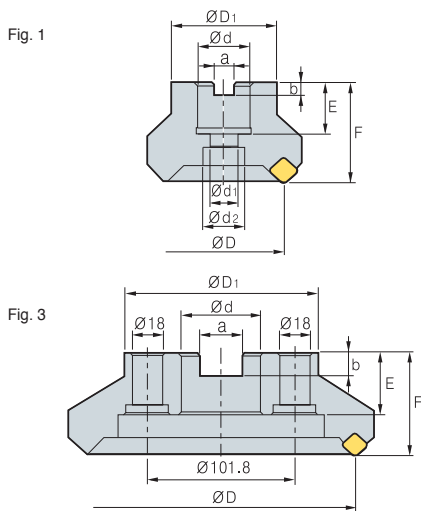


Designation	Dimensions (mm)						Cutter size
	D	L	K	S	h	d	
M8x1.25	20	20	7	6	-	-	Ø40
M10x1.5	28	24	9	8	-	-	Ø50, Ø63
M12x1.75	33	28	10	10	2	23	Ø80
M16x2	40	32	10	14	5	23	Ø100
M20x2.5	50	40	14	17	5	27	Ø125
M24x3	64	46	14	19	9	37	Ø160



Metric - ISO6462, DIN138

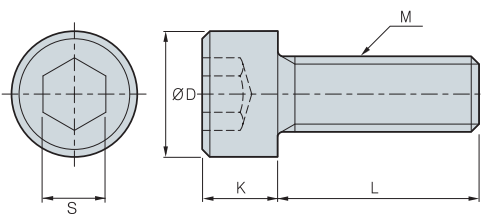
Clamping part of milling cutter



Metric type

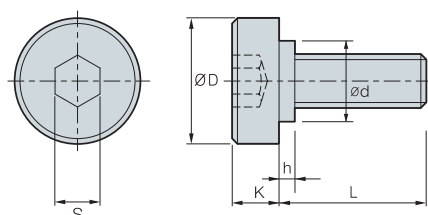
ØD	Dimensions (mm)					Fig.	Available arbors
	Ød	a	b	E	F		
40	16	8.4	5.6	18	40	1	FMC16, SMA16
50	22	10.4	6.3	20	40	1	FMC22
63	22	10.4	6.3	20	40	1	FMC22
80	27	12.4	7	22	50	1	FMC27
100	32	14.4	8	28	50	2	FMC32
125	40	16.4	9	32	63	2	FMB40
160	40	16.4	9	32	63	2	FMB40
200	60	25.7	14	38	63	3	FMB60
250	60	25.7	14	38	63	3	FMB60
315	60	25.7	14	38	63	4	-

Wrench bolt



Designation	ØD	S	K	L	M	Cutter size
SB0825	13	6	8	25	M08 x 1.25	Ø40
SB1025	16	8	10	25	M10 x 1.50	Ø50, Ø63
SB1035	16	8	10	35	M10 x 1.50	Ø50, Ø63 (HRM)
SB1230	18	10	12	30	M12 x 1.75	Ø80
SB1245	18	10	12	45	M12 x 1.75	Ø80 (HRM)
SB1630	24	14	16	30	M16 x 2.0	Ø100
SB1645	24	14	16	45	M16 x 2.0	Ø100 (HRM)
SB2040	30	17	20	40	M20 x 2.5	Ø125

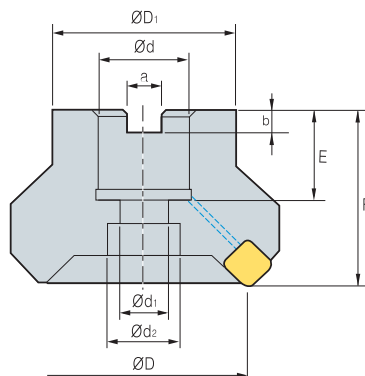
Clamp bolt



Designation	Dimensions (mm)						Cutter size
	D	L	K	S	h	d	
M12 x 1.75	33	28	10	10	2	23	Ø80
M16 x 2	40	32	10	14	5	23	Ø100
M20 x 2.5	50	40	14	17	5	27	Ø125, Ø160

Clamping part of milling cutter (Oil-hole)

Clamping part of milling cutter



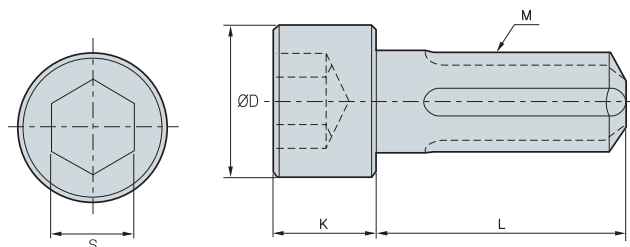
Inch type

Dimensions (mm)									Available arbors
ØD	Ød	a	b	E	F	ØD1	Ød1	Ød2	
40	16	8.4	5.6	19	40	34	9	14	FMC16, SMA16
50	22	10.4	6.3	21	40	42	11	18	FMC22
63	22	10.4	6.3	21	40	49	11	18	FMC22
80	25.4	9.5	6	24	50	57	14	20	FMA25.4, FMB25.4
100	31.75	12.7	8	32	63	67	18	26	FMA31.75, SMB31.75
125	38.1	15.9	10	35	63	87	22	32	FMA38.1, FMB38.1, FMC38.1

Metric type

Dimensions (mm)									Available arbors
ØD	Ød	a	b	E	F	ØD1	Ød1	Ød2	
40	16	8.4	5.6	19	40	34	9	14	FMC16, SMA16
50	22	10.4	6.3	21	40	42	11	18	FMC22
63	22	10.4	6.3	21	40	49	11	18	FMC22
80	27	12.4	7.0	23	50	57	14	20	FMC27
100	32	14.4	8.0	25	50	67	18	26	FMC32
125	40	16.4	9.0	29	63	87	22	32	FMB40/FMC40

Wrench bolt






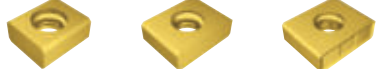


Designation	ØD	S	K	L	M	Cutter size
CB0825	13	6	8	25	M08×1.25	Ø40
CB1025	16	8	10	25	M10×1.50	Ø50, Ø63
CB1035	16	8	10	35	M10×1.50	Ø50, Ø63 (HRM)
CB1230	18	10	12	30	M12×1.75	Ø80
CB1245	18	10	12	45	M12×1.75	Ø80 (HRM)
CB1630	24	14	16	30	M16×2.0	Ø100
CB1645	24	14	16	45	M16×2.0	Ø100 (HRM)
CB2040	30	17	20	40	M20×2.5	Ø125









Gear cutter applicable example

Applicable example-external tooth gear

Finishing: M20	Semi-finishing	Roughing
 <ul style="list-style-type: none"> ■ Cutter Dia: Ø400 ■ Tooth No: 20 tooth ■ External tooth gear: Formal cutter for gear processing which can be expected to KS 4 level accuracy ■ Cutter can simultaneously chamfer while milling  <p>M20XZ130-EX</p>	 <ul style="list-style-type: none"> ■ Cutter Dia: Ø280 ■ Tooth No: 48 tooth ■ Designed for processing of external gear involute curve line shape ■ Possible to work for gear root portion R with optimal insert R design  <p>M20-M22-ROU</p>	 <ul style="list-style-type: none"> ■ Cutter Dia: Ø560 ■ Tooth No: 140 tooth ■ High feed rate with low cutting resistance due to V shape insert setting design  <p>LNE333-02-1 LNE434-02-1 KEL1906-C0.6-MF</p>

Applicable example-internal tooth gear

Finishing: M16	Semi-finishing	Roughing
 <ul style="list-style-type: none"> ■ Cutter Dia: Ø400 ■ Tooth No: 20 tooth ■ Internal tooth gear: Formal cutter for gear processing which can be expected to KS 4 level accuracy ■ Cutter can simultaneously chamfer while milling  <p>M16XZ130</p>	 <ul style="list-style-type: none"> ■ Cutter Dia: Ø280 ■ Tooth No: 48 tooth ■ The semi-finishing cutter was designed for processing of external gear involute curb line shape  <p>M16-M18-ROU LNE433-R60</p>	 <ul style="list-style-type: none"> ■ Cutter Dia: Ø560 ■ Tooth No: 40 tooth ■ Possible to use for gear processing of all module due to step type of insert setting design  <p>KEL1906-C0.6-MF LNE434-02-1</p>

Gear cutter machining example




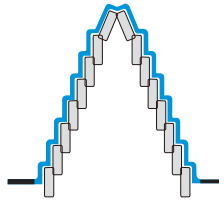

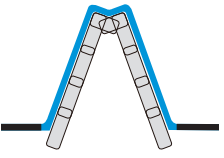

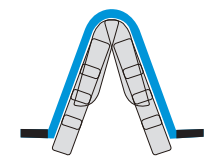

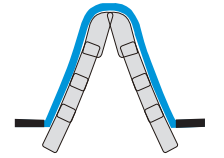

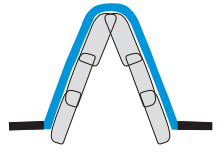

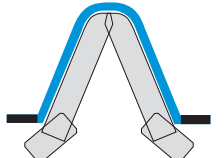

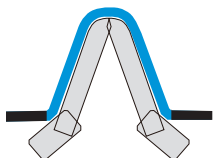

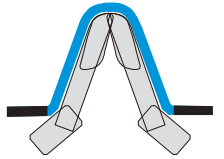
- **Machine**
Gleason-PFAUTER CNC Hobbing Machine (Power: 52kW)
- **Cutting condition**
vc = 119.98 m/min (n = 86.8 rpm)
fz = 0.518 mm/t (vf = 450 mm/min)
ae = 36 mm
Dry
- **Tools**
M16-PT-RACK-KOR03 (Ø440xW90)
- **Semi-finishing cutter (low cut, low resistance)**



- **Machine**
KARATS (30kw)
- **Cutting condition**
vc = 150 m/min, n = 119 rpm
fz = 0.09 mm/t, vf = 81.6 mm/min
ae = 45 mm
Dry
- **Tools**
M24 Semi-finishing External type Applicable Insert
M40-ROU (Main),
KEL150708-MX (Flank)



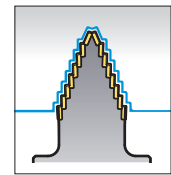
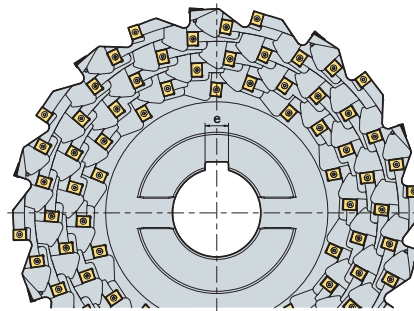
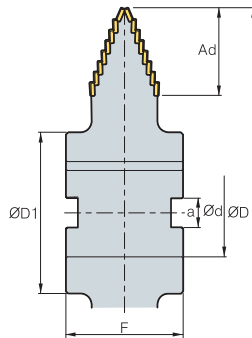
E Gear Cutter Table

Type	Cutter shape	Cutting-edge shape	Type	Feature
Roughing			Step type	<ul style="list-style-type: none"> • Working for big sized gear tooth • Low cutting resistance with step type insert setting
			V shape type	<ul style="list-style-type: none"> • Low cutting resistance with V shape cutting insert setting • Optimal cutting-edge line setting according to Rach type & cutting-edge shape
Semi-finishing			Low cutting resistance type	<ul style="list-style-type: none"> • 4-Corner insert on Root portion • 3D chip breaker shape on flank • Optimal cutting-edge line setting for low cutting resistance
			External gear high rigidity type	<ul style="list-style-type: none"> • Optimal R type insert setting on Root portion • Superior Semi-finishing cutting with high rigidity shape of cutter & insert
			Internal gear high rigidity type	<ul style="list-style-type: none"> • Exclusive semi-finishing Internal Gear insert • Optimal cutting-edge line setting with Internal tooth shape
Finishing			External gear	<ul style="list-style-type: none"> • Concave shape of cutting-edge line according to external gear type • Optimal cutting insert setting design according to a customer conditions
			Internal gear	<ul style="list-style-type: none"> • 2-corner insert setting on right & left side and chamfering insert setting • Adjustable chamfering cartridge use for chamfering control
			2 STEP type	<ul style="list-style-type: none"> • Exclusive insert for machining the root part • 4-cornered insert

• Optimal cutting insert setting design according to customer condition



Gear Roughing Cutter (Step type)



(mm)

m		ØD	Ad	Ød	ØD ₁	a	e	F
30	96	450	90	100	180	25	14	140
	108	500	90	100	180	25	14	140
	120	560	90	120	220	40	32	160
40	112	450	105	100	180	25	14	140
	126	500	105	100	180	25	14	140
	140	560	105	120	220	40	32	160
50	160	560	119	120	220	40	32	160

Available inserts

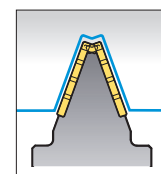
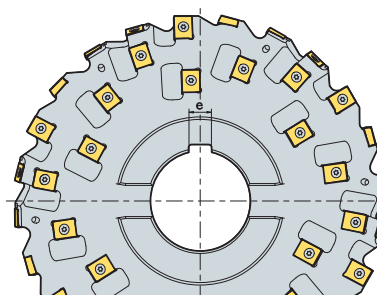
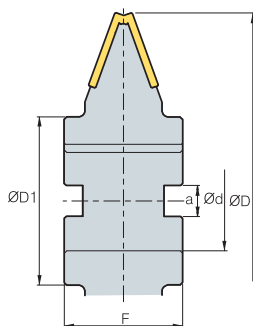
(mm)

Picture	Designation	Coated				Uncoated		Dimensions					Configuration
		NC5330	PC9530	PC3500	PC5300	H01	G10	l	d	t	d ₁	c	
 Reinforced cutting-edge	LNE 434-02-1			○	◎			19.05	14.29	6.35	5.4	0.6	
	KEL 1906-C0.6-MF 190610-MR			○	◎			19.05	14.29	6.35	5.4	0.6	
 Low cutting resistance	KEL 1906-C0.6-MF 190610-MR			○	◎			19.05	14.29	6.35	5.4	-	

※ The above specification is subject to change according to customer related condition & Korloy technical condition

©: 1st Rec ○: 2nd Rec

Gear Roughing Cutter (V shape type)



(mm)

m	Type		ØD	Ød	ØD ₁	a	e	F
20	rack	48	280	80	135	25	18	95
22	rack	48	280	80	135	25	18	95
24	rack	48	320	80	145	25	18	105
26	rack	60	320	80	145	25	18	105
28	rack	96	400	100	180	25	24	130
30	rack	96	400	100	180	25	24	130
32	rack	96	400	100	180	25	24	130
34	rack	112	400	100	180	25	24	130
36	rack	112	450	100	180	25	24	130
38	rack	112	450	100	180	25	24	130
40	rack	128	450	100	180	25	24	160
42	rack	128	450	100	180	25	24	160
44	rack	128	560	120	220	32	32	160
46	rack	144	560	120	220	32	32	160
48	rack	144	560	120	220	32	32	160
50	rack	144	560	120	220	32	32	160

Available inserts

(mm)

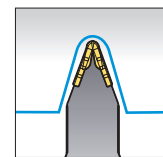
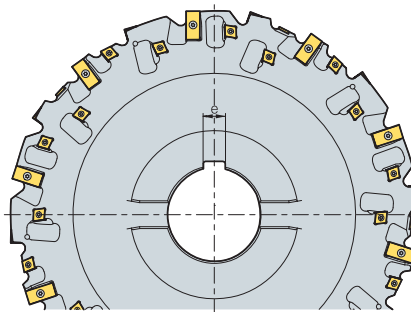
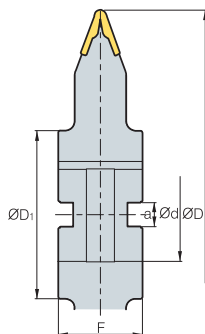
Picture	Designation	Coated				Uncoated		Dimensions					Configuration
		NC5330	PC9530	PC3500	PC5300	H01	G10	l	d	t	d ₁	c	
 Reinforced cutting-edge	LNE 434-02-1			○	◎			19.05	14.29	6.35	5.4	0.6	
 Low cutting resistance	LNE 1906-C0.6-MF 190610-MR			○	◎			19.05	14.29	6.35	5.4	-	
 Reinforced cutting-edge	KEL 333-02-1			○	◎			14.3	12.7	6.35	5.8	0.8	
 CNHQ 1005-C0.5	CNHQ 1005-C0.5							10	10	5.4	-	-	

* The above specification is subject to change according to customer related condition & Korloy technical condition

◎: 1st Rec ○: 2nd Rec



Gear Semi-finishing Cutter (Low cutting resistance type)



(mm)

m	No. of teeth		ØD	Ød	ØD ₁	a	e	F
6	30, 60, 120	18	250	60	100	25	18	70
8	30, 60, 120	18	250	60	100	25	18	80
10	30, 60, 120	24	250	60	100	25	18	80
12	30, 60, 120	24	250	60	100	25	18	90
14	30, 60, 120	24	280	80	135	25	24	95
16	30, 60, 120	32	280	80	135	25	24	100
18	30, 60, 120	32	320	80	145	25	24	105
20	30, 60, 120	64	400	100	180	25	24	110
22	30, 60, 120	64	400	100	180	25	24	110
24	30, 60, 120	64	400	100	180	25	24	120

Available inserts

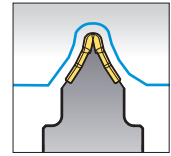
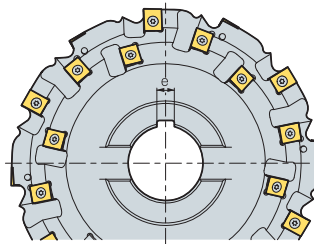
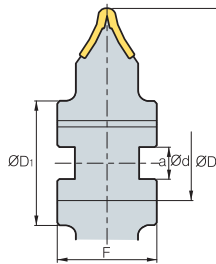
(mm)

Picture	Designation	Coated				Uncoated		Dimensions					Configuration
		NC5330	PC9530	PC3500	PC5300	H01	G10	l	d	t	d ₁	c	
	M6-2ST			○	◎			19.05	11.6	3.8	4.4	2.25	
	M8-2ST			○	◎			19.05	11.6	4	4.4	3	
	M10-2ST			○	◎			19.05	11.6	4.76	4.4	3.75	
	M12-2ST			○	◎			19.05	14.3	6.35	5.5	4.5	
	M14-2ST			○	◎			25.4	14.3	6.35	5.5	5.25	
	M16-2ST			○	◎			31.8	14.3	7.14	5.5	6	
	M18-2ST			○	◎			31.8	14.3	7.14	5.5	6.75	
	M20-2ST			○	◎			31.8	14.3	9.52	5.5	7.5	
	M22-2ST			○	◎			31.8	14.3	9.52	5.5	8.25	
M24-2ST			○	◎			31.8	14.3	9.52	5.5	9		
	KEC 120606-MX			○	◎			12	12.7	6.35	4.5	-	
	150708-MX			○	◎			15.15	15	7.6	5.8	-	

※ The above specification is subject to change according to customer related condition & Korloy technical condition

◎: 1st Rec ○: 2nd Rec

Gear Semi-finishing Cutter (High rigid edge type, External gear)



(mm)

m	No. of teeth		$\varnothing D$	$\varnothing d$	$\varnothing D_1$	a	e	F
12	30, 60, 120	24	250	60	100	25	14	70
14	30, 60, 120	36	250	60	100	25	14	80
16	30, 60, 120	36	250	60	100	25	14	80
18	30, 60, 120	36	250	60	100	25	14	90
20	30, 60, 120	48	280	80	135	25	18	95
22	30, 60, 120	48	280	80	135	25	18	100
24	30, 60, 120	48	320	80	145	25	18	105
26	30, 60, 120	72	400	100	180	25	24	110
28	30, 60, 120	72	400	100	180	25	24	110
30	30, 60, 120	72	400	100	180	25	24	120
32	30, 60, 120	84	400	100	180	25	24	130
34	30, 60, 120	84	400	100	180	25	24	130

Available inserts

(mm)

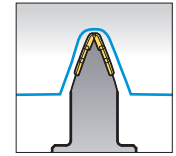
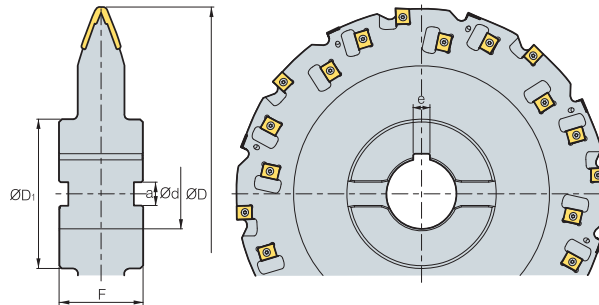
Picture	Designation	Coated				Uncoated		Dimensions						Configuration
		NC5330	PC9530	PC3500	PC5300	H01	G10	l	d	t	d_1	R	c	
	M8-ROU			○	◎			15.875	11	4.76	4.6	4.6	-	
	M12-M14-ROU			○	◎			19.05	14.29	6.35	5.4	5.4	-	
	M16-M18-ROU			○	◎			19.05	14.29	7	5.4	5.4	-	
	M20-M22-ROU			○	◎			19.05	14.29	7.94	5.4	5.4	-	
	M40-ROU			○	◎			25.4	14.29	9.52	5.4	5.4	-	
	LNE 434-02-1			○	◎			19.05	14.29	6.35	5.4	-	0.6	
	KEL 1906-C0.6-MF			○	◎			19.05	14.29	6.35	5.4	-	0.6	
	190610-MR			○	◎			19.05	14.29	6.35	5.4	-	-	

※ The above specification is subject to change according to customer related condition & Korloy technical condition

©: 1st Rec ○: 2nd Rec



Gear Semi-finishing Cutter (High rigid edge type, Internal gear)



(mm)

m	No. of teeth		ØD	Ød	ØD ₁	a	e	F
12	30, 60, 120	24	250	60	100	25	14	70
14	30, 60, 120	36	250	60	100	25	14	80
16	30, 60, 120	36	250	60	100	25	14	80
18	30, 60, 120	36	250	60	100	25	14	90
20	30, 60, 120	48	280	80	135	25	18	95
22	30, 60, 120	48	280	80	135	25	18	100
24	30, 60, 120	48	320	80	145	25	18	105
26	30, 60, 120	72	400	100	180	25	24	110
28	30, 60, 120	72	400	100	180	25	24	110
30	30, 60, 120	72	400	100	180	25	24	120
32	30, 60, 120	84	400	100	180	25	24	130
34	30, 60, 120	84	400	100	180	25	24	130

Available inserts

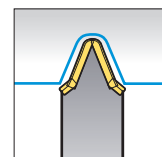
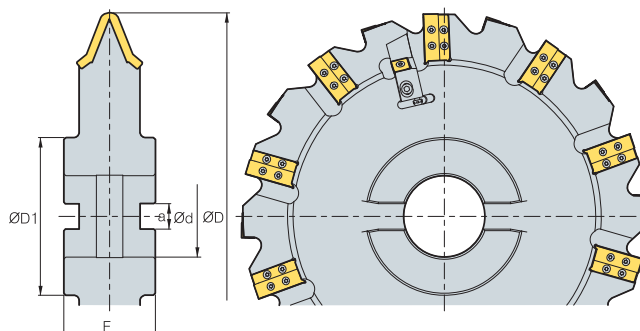
(mm)

Picture	Designation	Coated				Uncoated		Dimensions					Configuration
		NC5330	PC9530	PC3500	PC5300	H01	G10	l	d	t	d ₁	c	
	M8-ROU			○	◎			15.875	11	4.76	4.6	2	
	M12-M14-ROU			○	◎			19.05	14.29	6.35	5.4	3	
	M16-M18-ROU			○	◎			19.05	14.29	7	5.4	5	
	M20-M22-ROU			○	◎			19.05	14.29	7.94	5.4	7	
	M40-ROU			○	◎			25.4	14.29	9.52	5.4	10	
	LNE 433-R80			○	◎			19.05	14.29	5.56	5.4	2.5	


* The above specification is subject to change according to customer related condition & Korloy technical condition

◎: 1st Rec ○: 2nd Rec

Gear Finishing Cutter (1 Step type, External gear)


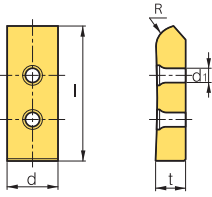
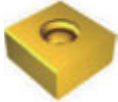
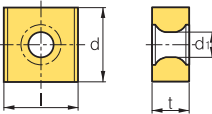


(mm)

m		$\varnothing D$	$\varnothing d$	$\varnothing D_1$	a	F
6	20	400	80	155	25	90
8	20	400	80	155	25	90
10	20	400	80	155	25	90
12	20	400	80	155	25	90
14	20	400	80	155	25	90
16	20	400	80	155	25	90
18	20	400	80	155	25	90
20	20	400	80	155	25	90
22	20	400	80	155	25	90
24	20	400	80	155	25	90

Available inserts

(mm)

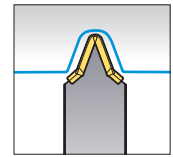
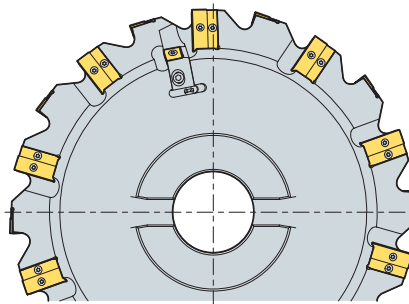
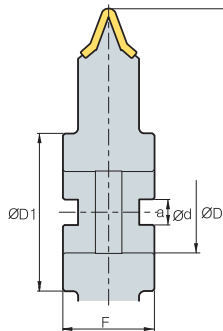
Picture	Designation	Coated				Uncoated		Dimensions					Configuration
		NC5330	PC9530	PC3500	PC5300	H01	G10	l	d	t	d ₁	R	
	M6			○	◎			19	14.3	5	5.5	2.25	
	M8			○	◎			27	14.3	5.4	5.5	3	
	M10			○	◎			29	14.3	6.35	5.5	3.75	
	M12			○	◎			33	14.3	6.35	5.5	4.5	
	M14			○	◎			39	14.3	6.35	5.5	5.25	
	M16			○	◎			43	14.3	7.94	5.5	6	
	M18			○	◎			50	14.3	7.94	5.5	6.75	
	M20			○	◎			54	14.3	9.53	5.5	7.5	
	M22			○	◎			57	14.3	9.53	5.5	8.25	
	M24			○	◎			64	14.3	9.53	5.5	9	
	SNEQ 1507-C0.8			○	◎			15.875	15.875	7.94	-	-	

※ The above specification is subject to change according to customer related condition & Korloy technical condition

◎: 1st Rec ○: 2nd Rec



Gear Finishing Cutter (1 Step type, Internal gear)



(mm)

m		ØD	Ød	ØD ₁	a	F
6	20	400	80	155	25	90
8	20	400	80	155	25	90
10	20	400	80	155	25	90
12	20	400	80	155	25	90
14	20	400	80	155	25	90
16	20	400	80	155	25	90
18	20	400	80	155	25	90
20	20	400	80	155	25	90
22	20	400	80	155	25	90
24	20	400	80	155	25	90

Available inserts

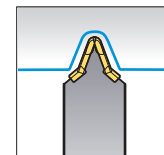
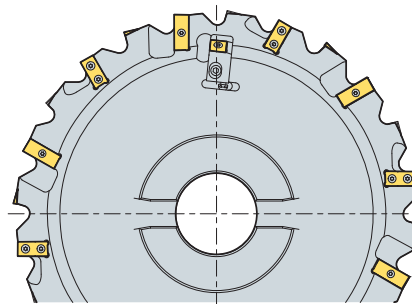
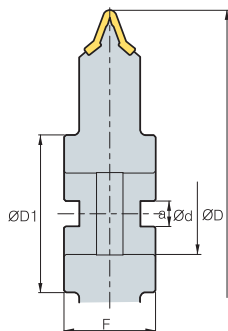
(mm)

Picture	Designation	Coated				Uncoated		Dimensions					Configuration
		NC5330	PC9530	PC3500	PC5300	H01	G10	l	d	t	d ₁	R	
	M6			○	◎			19	14.3	5	5.5	2.25	
	M8			○	◎			27	14.3	5.4	5.5	3	
	M10			○	◎			29	14.3	6.35	5.5	3.75	
	M12			○	◎			33	14.3	6.35	5.5	4.5	
	M14			○	◎			39	14.3	6.35	5.5	5.25	
	M16			○	◎			43	14.3	7.94	5.5	6	
	M18			○	◎			50	14.3	7.94	5.5	6.75	
	M20			○	◎			54	14.3	9.53	5.5	7.5	
	M22			○	◎			57	14.3	9.53	5.5	8.25	
	M24			○	◎			64	14.3	9.53	5.5	9	
	SNEQ 1507-C0.8			○	◎			15.875	15.875	7.94	-	-	

* The above specification is subject to change according to customer related condition & Korloy technical condition

◎: 1st Rec ○: 2nd Rec

Gear Finishing Cutter (2 Step type, Internal/External gear)



(mm)

m		ØD	Ød	ØD ₁	a	F
6	24	400	80	155	25	90
8	24	400	80	155	25	90
10	24	400	80	155	25	90
12	24	400	80	155	25	90
14	24	400	80	155	25	90
16	24	400	80	155	25	90
18	24	400	80	155	25	90
20	24	400	80	155	25	90
22	24	400	80	155	25	90
24	24	400	80	155	25	90

Available inserts

(mm)

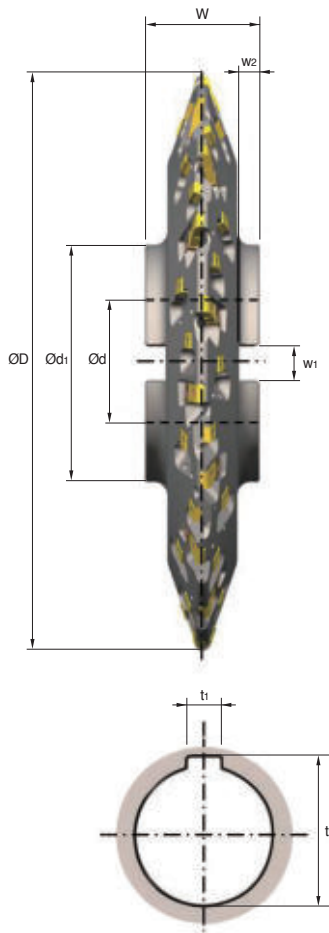
Picture	Designation	Coated				Uncoated		Dimensions					Configuration
		NC5330	PC9530	PC3500	PC5300	H01	G10	l	d	t	d ₁	R	
	M6		○		⊙			19	14.3	5	5.5	2.25	
	M8		○		⊙			27	14.3	5.4	5.5	3	
	M10		○		⊙			29	14.3	6.35	5.5	3.75	
	M12		○		⊙			33	14.3	6.35	5.5	4.5	
	M14		○		⊙			39	14.3	6.35	5.5	5.25	
	M16		○		⊙			43	14.3	7.94	5.5	6	
	M18		○		⊙			50	14.3	7.94	5.5	6.75	
	M20		○		⊙			54	14.3	9.53	5.5	7.5	
	M22		○		⊙			57	14.3	9.53	5.5	8.25	
	SNEQ 1507-C0.8		○		⊙			15.875	15.875	7.94	-	-	
	M6-2ST							19.05	11.6	3.8	4.4	2.25	
	M8-2ST							19.05	11.6	4	4.4	3	
	M10-2ST							19.05	11.6	4.76	4.4	3.75	
	M12-2ST							19.05	14.3	6.35	5.5	4.5	
	M14-2ST							25.4	14.3	6.35	5.5	5.25	
	M16-2ST							31.8	14.3	7.14	5.5	6	
	M18-2ST							31.8	14.3	7.14	5.5	6.75	
	M20-2ST							31.8	14.3	9.52	5.5	7.5	
	M22-2ST							31.8	14.3	9.52	5.5	8.25	
M24-2ST							31.8	14.3	9.52	5.5	9		

※ The above specification is subject to change according to customer related condition & Korloy technical condition

⊙: 1st Rec ○: 2nd Rec



➤ Gear cutter order form



Cutter type

- | | | |
|--|---|---|
| <input type="checkbox"/> Roughing | <input type="checkbox"/> Semi-finishing | <input type="checkbox"/> Finishing |
| <input type="checkbox"/> Step | <input type="checkbox"/> Low cutting resistance | <input type="checkbox"/> 1 Step |
| <input type="checkbox"/> V shape | <input type="checkbox"/> High rigid edge | <input type="checkbox"/> 2 Step |

■ Stock for finishing (one side) (mm):

■ Outside diameter $\varnothing D$ (mm):

■ Bore diameter $\varnothing d$ (mm):

■ Hub diameter $\varnothing d_1$ (mm):

■ Cutter width W (mm):

■ Radial keyway w_1 (mm):

■ Radial keyway w_2 (mm):

■ Axial keyway t_1 (mm):

■ Axial keyway t_2 (mm):

➤ Involute gear data

- | | | |
|---|---|---|
| <input type="checkbox"/> External gear | <input type="checkbox"/> Internal gear | <input type="checkbox"/> Rack gear |
|---|---|---|

■ Module M :

■ No. of teeth Z (mm):

■ Pressure angle α (°):

■ Helix angle β (°):

■ Addendum modification coefficient x :

■ Tip diameter d_a (mm):

■ Root diameter d_f (mm):

■ Root radius ρ_p (mm)

■ Base tangent length W_k (mm)

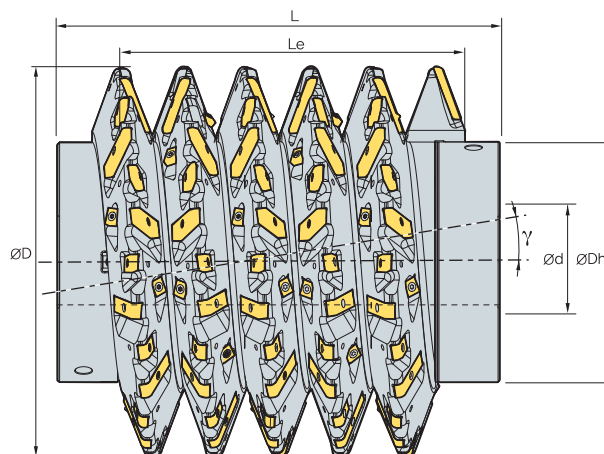
■ No. of measuring teeth K :

■ Dimensions/Dimension over balls M_d (mm):

■ Ball diameter D_M (mm):

■ Gear quality (DIN, JIS):

Indexable HOB

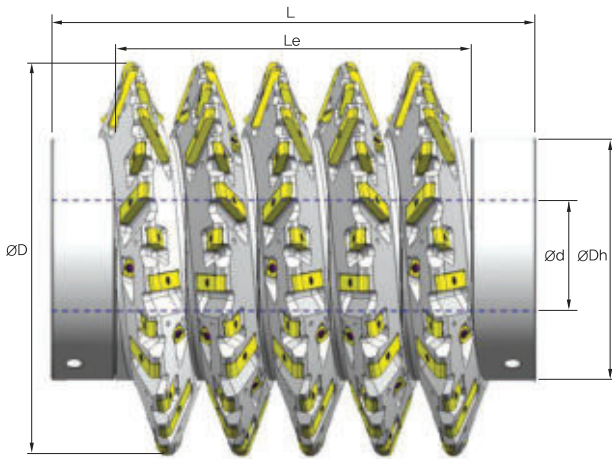


(mm)

Gear module	$\varnothing D$	$\varnothing D_h$	$\varnothing d$	No.Segm. (Pitch)	L_e	Segment insert	Total insert	γ (Lead Ang.)
6	180	125	40	6	(113)	15	90	2.084
	210	125	50	6	(113)	17	102	1.763
	240	160	60	6	(113)	19	114	1.528
7	180	125	40	6	(132)	15	90	2.469
	210	125	50	6	(132)	17	102	2.084
	240	160	60	6	(132)	19	114	1.803
8	210	125	50	6	(151)	17	102	2.413
	240	160	60	6	(151)	19	114	2.084
	270	180	80	6	(151)	21	126	1.834
9	210	125	50	6	(169)	17	102	2.751
	240	160	60	6	(169)	19	114	2.372
	270	180	80	6	(169)	21	126	2.084
10	210	125	50	6	(189)	17	102	3.099
	240	160	60	6	(189)	19	114	2.666
	270	180	80	6	(189)	21	126	2.339
12	240	140	60	6	(226)	18	108	3.276
	270	180	80	6	(226)	22	132	2.866
	350	215	80	6	(226)	26	156	2.149
14	270	180	80	6	(264)	22	132	3.415
	350	215	80	6	(264)	26	156	2.547
16	270	160	80	6	(302)	22	132	3.989
	350	215	80	6	(302)	26	156	2.959
18	270	145	80	5	(283)	22	110	4.589
	350	215	80	5	(283)	26	130	3.383
20	350	215	80	5	(314)	26	130	3.823
	450	265	100	5	(314)	34	170	2.866



Indexable HOB



Tool SPEC.

■ Outside diameter ØD (mm):

■ Bore diameter Ød (mm):

■ Hub diameter ØDh (mm):

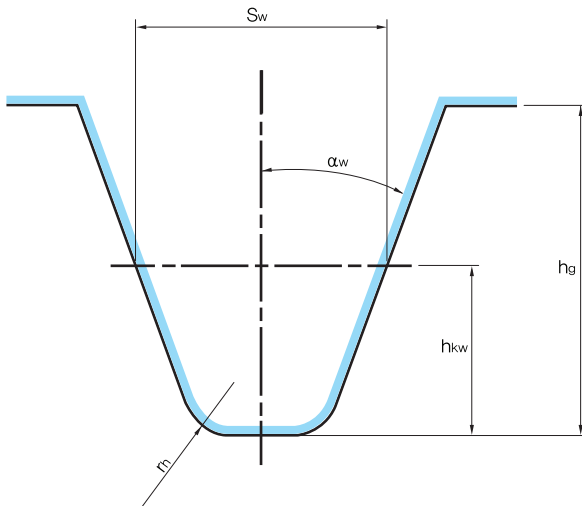
■ Hob length L (mm):

■ Cutting length L_e (mm):

■ Spiral direction RH/LH:

■ Quality class acc. to DIN 3968:

Profile of hob [Module m6~]



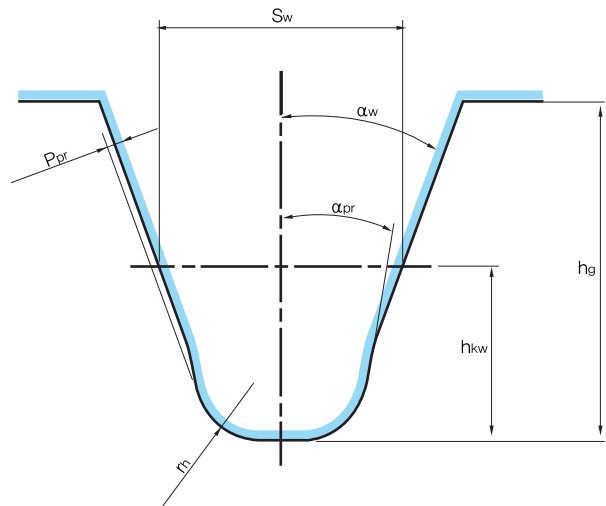
■ Module M :

■ Addendum h_{kw} (mm):

■ Tooth thickness S_w (mm):

■ Tooth depth h_g (mm):

Profile of roughing hob [Module m8~]



■ Pressure angle α_w (mm):

■ Protuberance amount P_{pr} (mm):

■ Protuberance angle α_{pr} (mm):

■ Tip radius r_h (mm):

DRILL

Korloy drills provide a total solution for hole making, based on tooling know-how as well as extensive research and development for our tools.



F

Technical Information for Drills

- F02** KORLOY Drills
- F03** Available Insert

Indexable Drills

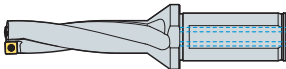
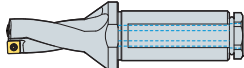
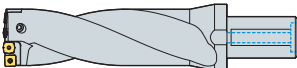
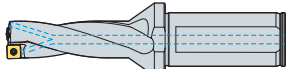
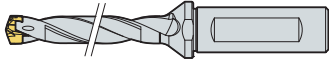
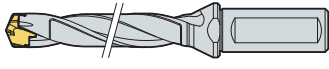
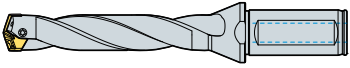
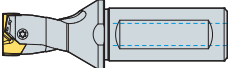
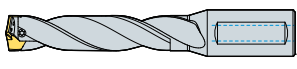
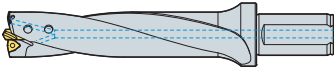


- F05** Technical Information for King Drill
- F11** King Drill
- F20** Technical information of King Drill (for through coolant system with a lathe)
- F21** King Drill (for through coolant system with a lathe)
- F24** Technical Information for King Drill (for large diameter drilling)
- F25** King Drill (for large diameter drilling)
- F26** Technical Information for KED Plus Drill
- F29** KED Plus Drill
- F37** Technical Information for TPDC Plus Drill
- F47** TPDC Plus Drill
- F54** Technical Information for TPDB Plus Drill
- F57** TPDB Plus Drill
- F63** Technical Information for TPDB-F
- F66** TPDB-F
- F68** Technical Information for TPDB-H
- F71** TPDB-H

Indexable Drills

- F75** Technical Information for WPDC
- F78** Center Drill
- F79** WPDC

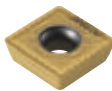
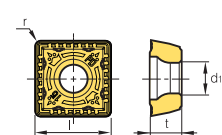

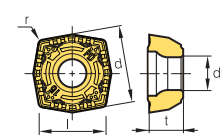

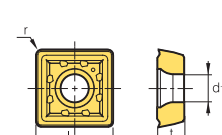

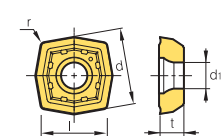

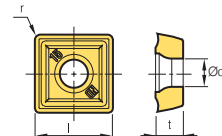
Reamer

- F82** Technical Information for Indexable Reamer
- F86** Indexable Reamer

Type	Designation		Shape	Drills dia.	Aspect ratio	Page
Indexable Drills	King Drill	K□D	 Available insert: SP□T, XO□T	Ø12.0~Ø60.5	2D~5D	F11~F19
	King Drill HP	K□D..HP	 Available insert: SP□T, XO□T	Ø12.0~Ø60.5	2D~4D	F21~F23
	King Drill (for large diameter drilling)	K□D	 Available insert: SP□T, XO□T	Ø61.0~Ø100.0	2D~4D	F25
	KED Plus Drill <small>new</small>	E□D	 Available insert: SP□T, XO□T	Ø12.0~Ø60.5	2D~5D	F29~F36
	TPDC Plus Drill <small>new</small>	TPDX	 Available insert: TP□□□□XP	Ø8.0~Ø11.9	3D~8D	F50
		TPDC	 Available insert: TP□□□□C□	Ø12.0~Ø30.9	1.5D~12D	F51~F53
	TPDB Plus Drill <small>new</small>	TPDB-P	 Available insert: TP□□□□B	Ø10.0~Ø32.9	3D~12D	F58~F62
		TPDB-F	 Available insert: TP□□□□B-F	Ø14.0~Ø30.9	1.5D	F67
		TPDB-H	 Available insert: TP□□□□B-H	Ø14.0~Ø30.9	3D~8D	F72~F74
	Indexable Drills & Drill with center	WPDC	 Available insert: WC□T	Ø25.0~Ø80.0	5D~8D	F79~F81
Reamer	Indexable Reamer	IRT	 Available Insert: RI	Ø10.0~Ø31.0	3D~5D	F86
		IRB	 Available Insert: RI	Ø10.0~Ø31.0	3D~5D	F87




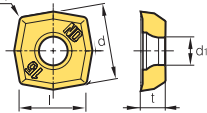

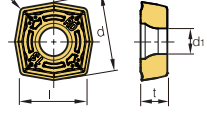

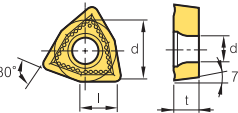

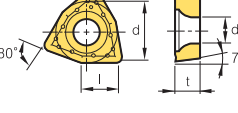
Available insert

Picture	Designation	Coated								Uncoated	Dimensions (mm)					Configuration	Page
		NC5330	NCM535	PC3700	PC6510	PC9530	PC9540	PC5335	PC5300	H01	l	d	t	r	d ₁		
 [Peripheral] SPMT-PD Universal	040204-PD	●	●	●	●		●		●		4.7	-	2.4	0.4	2.3		F11~ F36
	050204-PD	●	●	●	●		●		●		5.1	-	2.4	0.4	2.3		
	060205-PD	●	●	●	●		●		●		6.2	-	2.5	0.5	2.5		
	07T208-PD	●	●	●	●		●		●		7.5	-	2.8	0.7	2.8		
	090308-PD	●	●	●	●		●		●		9.2	-	3.3	0.8	3.4		
	11T308-PD	●	●	●	●		●		●		11.0	-	4.0	0.8	4.0		
	130410-PD	●	●	●	●		●		●		13.0	-	4.5	1.0	4.5		
	15M510-PD	●	●	●	●		●		●		15.2	-	5.0	1.0	5.5		
	180510-PD	●	●	●	●		●		●		18.2	-	5.5	1.0	6.0		
 [Central] XOMT-PD Universal	040204-PD								●		4.3	4.9	2.4	0.4	2.3		F11~ F36
	050204-PD								●		4.8	5.4	2.4	0.4	2.3		
	060204-PD								●		5.8	6.6	2.5	0.4	2.5		
	07T205-PD								●		6.9	7.8	2.8	0.5	2.8		
	090305-PD								●		8.4	9.6	3.3	0.5	3.4		
	11T306-PD								●		10.0	11.4	4.0	0.6	4.0		
	130406-PD								●		11.9	13.6	4.5	0.6	4.5		
	15M508-PD								●		13.9	15.9	5.0	0.8	5.5		
	180508-PD								●		16.5	18.9	5.5	0.8	6.0		
 [Peripheral] SPMT-LD Mild steel	060205-LD								●		6.2	-	2.5	0.5	2.5		F11~ F36
	07T208-LD								●		7.5	-	2.8	0.7	2.8		
	090308-LD								●		9.2	-	3.3	0.8	3.4		
	11T308-LD								●		11.0	-	4.0	0.8	4.0		
	130410-LD								●		13.0	-	4.5	1.0	4.5		
	15M510-LD								●		15.2	-	5.0	1.0	5.5		
	180510-LD								●		18.2	-	5.5	1.0	6.0		
 [Central] XOMT-LD Mild steel	060204-LD								●		5.8	6.6	2.5	0.4	2.5		F11~ F36
	07T205-LD								●		6.9	7.8	2.8	0.5	2.8		
	090305-LD								●		8.4	9.6	3.3	0.5	3.4		
	11T306-LD								●		10.0	11.4	4.0	0.6	4.0		
	130406-LD								●		11.9	13.6	4.5	0.6	4.5		
	15M508-LD								●		13.9	15.9	5.0	0.8	5.5		
	180508-LD								●		16.5	18.9	5.5	0.8	6.0		
 [Peripheral] SPET-ND Al	040204-ND								●		4.7	-	2.4	0.4	2.3		F11~ F36
	050204-ND								●		5.1	-	2.4	0.4	2.3		
	060205-ND								●		6.2	-	2.5	0.5	2.5		
	07T208-ND								●		7.5	-	2.8	0.7	2.8		
	090308-ND								●		9.2	-	3.3	0.8	3.4		
	11T308-ND								●		11.0	-	4.0	0.8	4.0		
	130410-ND								●		13.0	-	4.5	1.0	4.5		
	15M510-ND								●		15.2	-	5.0	1.0	5.5		
	180510-ND								●		18.2	-	5.5	1.0	6.0		

● : Stock Item

F Available Insert

Available insert

Picture	Designation	Coated							Uncoated	Dimensions (mm)					Configuration	Page
		NC5330	NCM535	PC3700	PC6510	PC9530	PC9540	PC5335		PC5300	H01	l	d	t		
 AI	[Central]								●	4.3	4.9	2.4	0.4	2.3		F11~ F36
		040204-ND							●	4.3	4.9	2.4	0.4	2.3		
		050204-ND							●	4.8	5.4	2.4	0.4	2.3		
		060204-ND							●	5.8	6.6	2.5	0.4	2.5		
		07T205-ND							●	6.9	7.8	2.8	0.5	2.8		
		090305-ND							●	8.4	9.6	3.3	0.5	3.4		
		11T306-ND							●	10.0	11.4	4.0	0.6	4.0		
		130406-ND							●	11.9	13.6	4.5	0.6	4.5		
		15M508-ND							●	13.9	15.9	5.0	0.8	5.5		
	180508-ND							●	16.5	18.9	5.5	0.8	6.0			
 Rein forced cutting-edge	[Central]								●	6.9	7.8	2.8	0.7	2.8		F11~ F36
		07T207-RD							●	6.9	7.8	2.8	0.7	2.8		
		090308-RD							●	8.4	9.6	3.3	0.8	3.4		
		11T309-RD							●	10.0	11.4	4.0	0.9	4.0		
		130410-RD							●	11.9	13.6	4.5	1.0	4.5		
		15M511-RD							●	13.9	15.9	5.0	1.1	5.5		
		180512-RD							●	16.5	18.9	5.5	1.2	6.0		
		030208-C20N							●	3.8	5.56	2.38	0.8	2.8		-
		040208-C20N							●	4.3	6.35	2.38	0.8	3.0		
		050308-C20N	●						●	5.4	7.94	3.18	0.8	3.4		
		06T308-C20N	●						●	6.5	9.525	3.97	0.8	3.7		
		080408-C20N							●	8.7	12.7	4.76	0.8	4.3		
		080412-C20N	●						●	8.7	12.7	4.76	1.2	4.3		
		030204-C21N							●	3.8	5.56	2.38	0.4	2.55		F79~ F81
		040204-C21N							●	4.3	6.35	2.38	0.4	2.8		
		040208-C21N							●	4.3	6.35	2.38	0.8	2.8		
		050308-C21N							●	5.4	7.94	3.18	0.8	3.4		
		06T308-C21N							●	6.5	9.525	3.97	0.8	4.4		
		080408-C21N							●	8.7	12.7	4.76	0.8	5.5		


●: Stock Item



Optimized insert design for maximum drilling efficiency

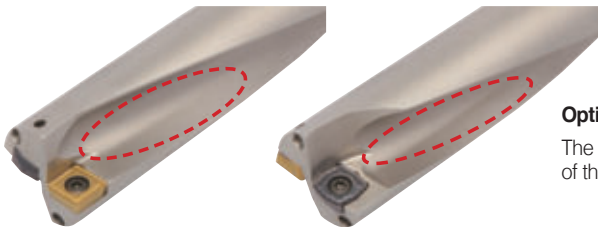
King Drill

Code system

K	5D	200	25		-	07
KING/KORLOY	Aspect ratio (L/D) 2D, 3D, 4D, 5D	Drill Dia. Ø20.0 mm (One decimal place marked)	Shank Dia. Ø20 Ø25 Ø32 Ø40 mm	Shank shape No mark: Flange Shank, Weldone HP: Flange Shank, Weldon, PT Tap F1: Flange Shank, Whistle Notch F2: Flange Shank, Without Side Lock S: Straight Shank, Weldone S1: Straight Shank, Whistle Notch S2: Straight Shank, Without Side Lock M0, M1, M2, M3... : MT0, MT1, MT2, MT3... H63, H100: HSK63, HSK100 B30, B40, B50: BT30, BT40, BT50		Inscribed circle of insert 04, 05, 06, 07, 09, 11, 13, 15, 18

Features

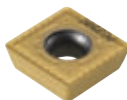






- Optimized design of inserts for maximum drilling efficiency
- Excellent cutting performance and chip control due to the optimized geometry and chip breaker of both inserts, central & peripheral
- Different inserts, optimized for the central and peripheral insert locations in order to maximize cutting tool life



Optimized flute system - 2 coolant holes applied

The optimized shape of the flute increases the rigidity of the drill body and improves chip evacuation

Features of chip breaker

Chip breaker	PD		LD		ND		RD
Features	- Universal - At medium speed and medium feed		- Superior chip control for machining mild steel and stainless steel - Light cutting (at low-medium speed and low feed)		- Sharp cutting edge for aluminum machining - Insert surface buffed for high quality result - E Class tolerance		- Improved chipping resistance - Excellent performance in case of frequent fracture and chipping on the cutting edge
Insert	Peripheral insert	Central insert	Peripheral insert	Central insert	Peripheral insert	Central insert	Central insert
Shape							
Grades for workpiece	NC5330: P, M, K PC3700: P PC5300: P, M, K, S PC6510: K PC9540: P, M, S		PC5335: P, M		H01: N		PC5300: P, M, K, S

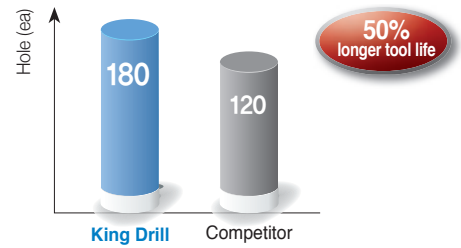
F Technical Information for King Drill

Application examples

- **Use** Track link bush
- **Workpiece** SM45C
- **Cutting conditions** vc (m/min) = 120, fn (mm/rev) = 0.1
Through coolant system
- **Tools** **Inserts** SPMT07T208-PD (PC3700)
XOMT07T205-PD (PC5300)
Holder K5D20025-07
- **Machine** Drilling machine



Test result

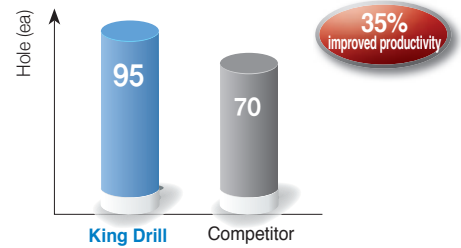


- Superior surface finish and chip evacuation

- **Use** Track link bush
- **Workpiece** SCM415H
- **Cutting conditions** Competitor: vc (m/min) = 125, fn (mm/rev) = 0.1
King Drill: vc (m/min) = 140, fn (mm/rev) = 0.12
- **Tools** **Inserts** SPMT090308-PD (PC3700)
XOMT090305-PD (PC5300)
Holder K3D27032-09
- **Machine** MCT



Test result



- Increased productivity due to higher capabilities for cutting conditions compared to the competitor

Recommended cutting condition

Workpiece			Insert			vc (m/min)	Aspect ratio (L/D) = 2D, 3D, 4D					
ISO	Workpiece	Hardness (HB)	Chip breaker	Grade			Feed rate (mm/rev) per drill dia. (mm)					
				Central	Peripheral		Ø12~Ø16	Ø17~Ø23	Ø24~Ø29	Ø30~Ø42	Ø43~Ø60	Ø61~Ø100
P	Carbon steel	80~180	LD	PC5335	PC5335	120 (60~170)	0.04~0.08	0.04~0.08	0.04~0.08	0.04~0.08	0.04~0.08	0.04~0.08
				PC5300	PC3700	150 (120~180)						
			PD/RD	PC5300	NC5330	180 (140~220)						
	Alloy steel	180~280	PD	PC5300	PC3700	120 (90~150)	0.04~0.10	0.04~0.12	0.05~0.16	0.06~0.16	0.06~0.18	0.06~0.18
					NC5330	150 (110~190)	0.04~0.06	0.04~0.07	0.04~0.08	0.04~0.08	0.04~0.08	0.04~0.08
					PC3700	150 (120~170)	0.06~0.12	0.06~0.12	0.06~0.14	0.06~0.16	0.06~0.16	0.06~0.16
Alloy steel	140~260	LD	PC5335	PC5335	120 (60~160)	0.06~0.10	0.06~0.10	0.06~0.12	0.06~0.14	0.06~0.14	0.06~0.14	
				PC5300	NC5330	180 (140~210)	0.06~0.08	0.06~0.08	0.06~0.10	0.06~0.12	0.06~0.12	0.06~0.12
				PC5300	PC5300	100 (50~150)	0.04~0.10	0.06~0.10	0.06~0.12	0.06~0.14	0.06~0.14	0.06~0.14
Alloy steel	260~320	PD	PC5300	PC3700	100 (50~160)	0.05~0.11	0.05~0.11	0.05~0.13	0.05~0.15	0.05~0.15	0.05~0.15	
				PC5300	PC5300	70 (30~120)	0.04~0.08	0.06~0.08	0.06~0.10	0.06~0.12	0.06~0.12	0.06~0.12
Alloy steel	300~450	PD	PC5300	PC5300	70 (30~120)	0.04~0.08	0.06~0.08	0.06~0.10	0.06~0.12	0.06~0.12	0.06~0.12	
				PC5300	PC5300	70 (30~120)	0.04~0.08	0.06~0.08	0.06~0.10	0.06~0.12	0.06~0.12	0.06~0.12
M	Stainless steel	135-275	LD	PC5335	PC5335	120 (80~140)	0.04~0.07	0.04~0.07	0.04~0.07	0.04~0.08	0.04~0.08	0.04~0.08
				PC5300	PC5300	130 (100~160)	0.04~0.07	0.04~0.07	0.04~0.07	0.04~0.08	0.04~0.08	0.04~0.08
				PC9540	PC9540	90 (60~120)	0.04~0.07	0.04~0.07	0.04~0.07	0.04~0.08	0.04~0.08	0.04~0.08
K	Cast iron	150~230	PD	PC5300	PC6510	190 (150~250)	0.04~0.12	0.05~0.14	0.06~0.18	0.10~0.22	0.10~0.26	0.10~0.26
				PC5300	PC6510	130 (100~160)	0.04~0.07	0.04~0.08	0.04~0.10	0.05~0.12	0.05~0.12	0.05~0.12
S	Heat resisting alloy	130~400	PD	PC5300	PC5300	50 (30~100)	0.04~0.10	0.04~0.10	0.04~0.10	0.04~0.10	0.04~0.10	0.04~0.10
				PC9540	PC9540	40 (20~80)	0.04~0.10	0.04~0.10	0.04~0.10	0.04~0.10	0.04~0.10	0.04~0.10
		130~400	LD	PC5335	PC5335	60 (40~80)	0.04~0.08	0.04~0.10	0.06~0.12	0.06~0.14	0.06~0.16	0.06~0.16
				PC5300	PC5300	60 (40~80)	0.04~0.08	0.04~0.10	0.06~0.12	0.06~0.14	0.06~0.16	0.06~0.16
Aluminium	30~150	ND	H01	H01	300 (250~400)	0.05~0.14	0.06~0.16	0.10~0.20	0.10~0.22	0.12~0.25	0.12~0.25	
						150~160	ND	H01	H01	250 (200~300)	0.05~0.14	0.06~0.16

- The Max. feed of 5D holders is 70%~80% of the max. conditions of 2D/3D/4D holders
- In interrupted machining part, reduce 30~50% of feed from the above machining around interrupted part



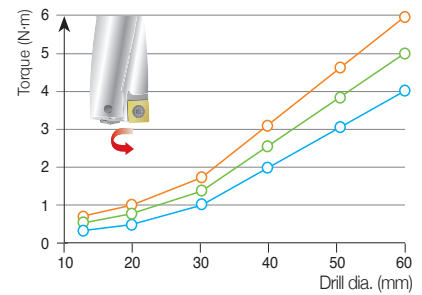
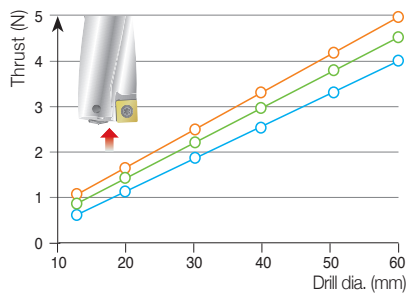
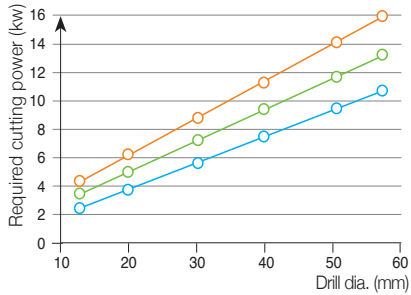
Required cutting power

- The graphs below show the cutting force required in drilling
- Machining with the King Drill and a machine with high rigidity and power

■ **Workpiece** SCM440 (240HB)

■ **Cutting conditions** vc (m/min) = 100, Through coolant system

—○— f_n (mm/rev) = 0.13 —○— f_n (mm/rev) = 0.10 —○— f_n (mm/rev) = 0.07

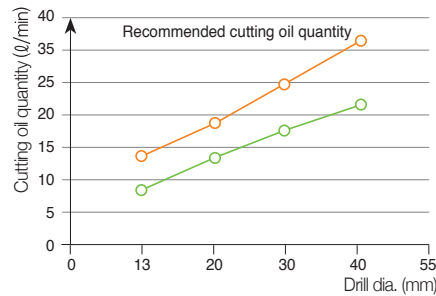


Cutting oil quantity

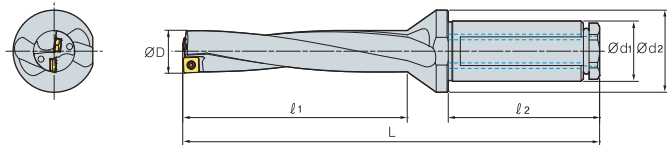
■ **Workpiece** SCM440 (240HB)

■ **Cutting conditions** vc (m/min) = 100, Through coolant system

- The data of the graph above could be changed depending on workpiece and cutting condition

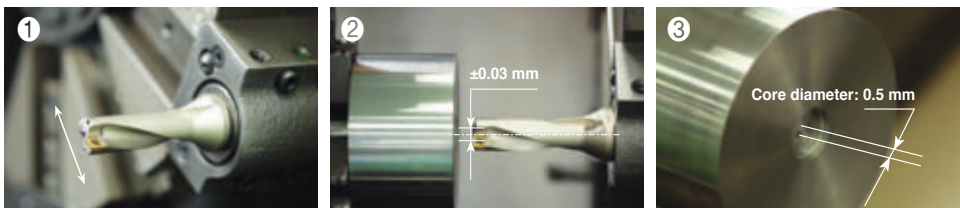


Drill tolerance and hole tolerance



Drill dia.		Ø12~Ø29	Ø30~Ø45	Ø46~Ø60.5
2D~3D	Drill tolerance (ØD)	0~-0.15	0~-0.15	0~-0.15
	Hole tolerance	+0.2~-0.1	+0.25~-0.1	+0.28~-0.1
4D~5D	Drill tolerance (ØD)	0~-0.15	0~-0.15	0~-0.15
	Hole tolerance	+0.25~-0.05	+0.3~-0.05	+0.33~-0.05

Notice for setting the drill in the lathe

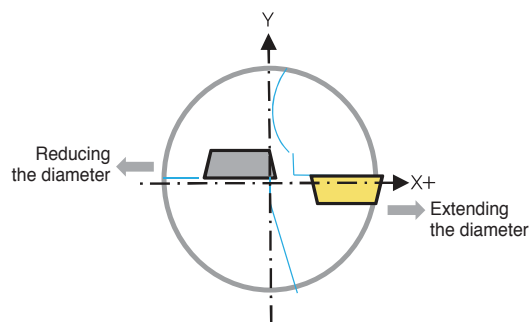


- Set the peripheral insert parallel to the X axis. (based on the side lock)
- If the machined core is 0.5 mm after machining 5 mm, that is the proper setting
- ※ Please make sure that the location of the side lock could be different depending on manufacturers of machine

F Technical Information for King Drill

◉ Range of adjusting machining diameter in the lathe

- In machining in the lathe, the King Drill can extend and reduce the machining diameter by adjusting the x-axis. Please refer to the table showing the range of adjusting drilling diameter below
- The more the drilling diameter is extended or reduced, the more the drill loses drilling balance. In this case, reduce the feed or cutting speed in machining
- Reducing the machining diameter excessively could damage the holder



(mm)

Drill dia. (Ø)	Range of adjusting drilling diameter (Ø)	Drill dia. (Ø)	Range of adjusting drilling diameter (Ø)	Drill dia. (Ø)	Range of adjusting drilling diameter (Ø)	Drill dia. (Ø)	Range of adjusting drilling diameter (Ø)
12.0	11.7~12.4	24.5	23.9~25.1	37.0	36.3~37.7	49.5	48.7~50.2
12.5	12.2~12.9	25.0	24.4~25.6	37.5	36.8~38.2	50.0	49.2~50.7
13.0	12.7~13.4	25.5	24.9~26.1	38.0	37.3~38.7	50.5	49.7~51.2
13.5	13.2~13.9	26.0	25.4~26.6	38.5	37.8~39.2	51.0	50.2~51.7
14.0	13.6~14.5	26.5	25.9~27.1	39.0	38.3~39.7	51.5	50.7~52.2
14.5	14.1~15.0	27.0	26.4~27.6	39.5	38.8~40.2	52.0	51.2~52.7
15.0	14.6~15.5	27.5	26.9~28.1	40.0	39.3~40.7	52.5	51.7~53.2
15.5	15.1~16.0	27.8	27.4~28.6	40.5	39.8~41.2	53.0	52.2~53.7
16.0	15.6~16.5	28.5	27.9~29.1	41.0	40.3~41.7	53.5	52.7~54.2
16.5	16.0~17.0	29.0	28.4~29.6	41.5	40.8~42.2	54.0	53.2~54.7
17.0	16.5~17.5	29.5	28.9~30.1	42.0	41.3~42.7	54.5	53.7~55.2
17.5	17.0~18.0	30.0	29.3~30.7	42.5	41.8~43.2	55.0	54.2~55.7
18.0	17.5~18.5	30.5	29.8~31.2	43.0	42.2~43.7	55.5	54.7~56.2
18.5	18.0~19.0	31.0	30.3~31.7	43.5	42.7~44.2	56.0	55.2~56.7
19.0	18.5~19.5	31.5	30.8~32.2	44.0	43.2~44.7	56.5	55.7~57.2
19.5	19.0~20.0	32.0	31.3~32.7	44.5	43.7~45.2	57.0	56.2~57.7
20.0	19.4~20.6	32.5	31.8~33.2	45.0	44.2~45.7	57.5	56.7~58.2
20.5	19.9~21.1	33.0	32.3~33.7	45.5	44.7~46.2	58.0	57.2~58.7
21.0	20.4~21.6	33.5	32.8~34.2	46.0	45.2~46.7	58.5	57.7~59.2
21.5	20.9~22.1	34.0	33.3~34.7	46.5	45.7~47.2	59.0	58.2~59.7
22.0	21.4~22.6	34.5	33.8~35.2	47.0	46.2~47.7	59.5	58.7~60.2
22.5	21.9~23.1	35.0	34.3~35.7	47.5	46.7~48.2	60.0	59.2~60.7
23.0	22.4~23.6	35.5	34.8~36.2	48.0	47.2~48.7	60.5	59.7~61.2
23.5	22.9~24.1	36.0	35.3~36.7	48.5	47.7~49.2		
24.0	23.4~24.6	36.5	35.8~37.2	49.0	48.2~49.7		

◉ Insert and parts

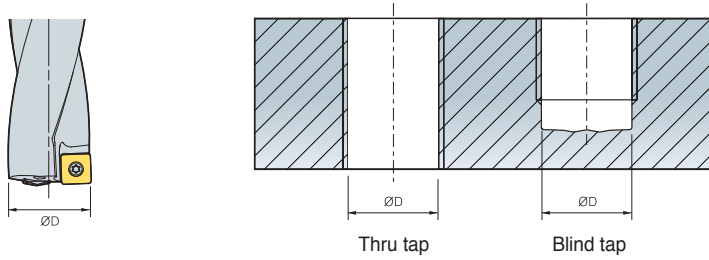
Drill dia. (mm)	Peripheral insert	Central insert	Screw	Wrench	Torque (N·m)
Ø12.0~Ø13.5	SP□T040204-□□	XO□T040204-□□	FTNA0204	TW06P	0.4
Ø13.6~Ø16.0	SP□T050204-□□	XO□T050204-□□	FTNA0204	TW06P	0.4
Ø16.1~Ø19.5	SP□T060205-□□	XO□T060204-□□	FTKA02206S	TW07P	0.8
Ø19.6~Ø23.5	SP□T07T208-□□	XO□T07T205-□□	FTKA02565	TW07S	0.8
Ø23.6~Ø29.5	SP□T090308-□□	XO□T090305-□□	FTKA0307	TW09S	1.2
Ø29.6~Ø35.5	SP□T11T308-□□	XO□T11T306-□□	FTKA03508	TW15S	3
Ø35.6~Ø42.5	SP□T130410-□□	XO□T130406-□□	FTKA0410	TW15S	3
Ø42.6~Ø50.5	SP□T15M510-□□	XO□T15M508-□□	FTNC04511	TW20S	5
Ø50.6~Ø60.5	SP□T180510-□□	XO□T180508-□□	FTNA0511	TW20-100	5

- In clamping an insert, please clean the tip seat and apply CASMOLY1000 on the screw
- Please make sure to use a Korloy-produced wrench and screw only



King Drill - for machining a tap foundation hole

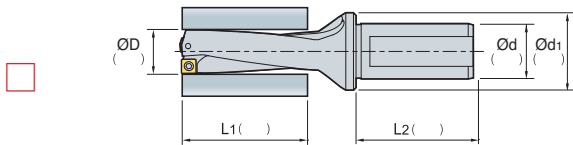
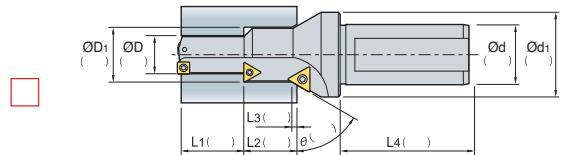
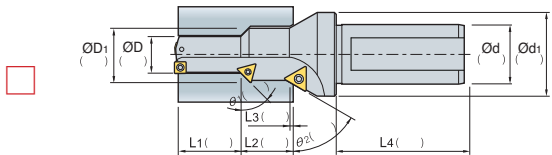
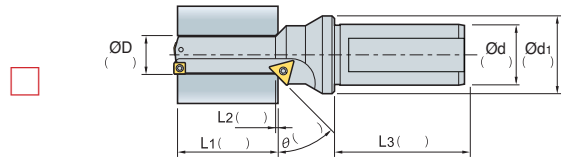
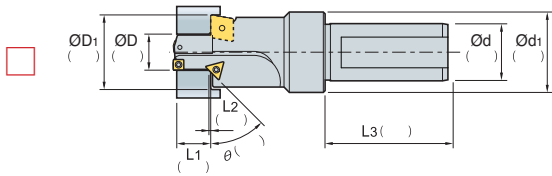
- There are two types of specifications of tap, metric and inch. The King Drill is available for machining both thru tap and blind tap



(mm)

Tap type	Thread	ØD	Designation	Reference
Metric	M14 x 2.0	12.0	K3D12020-04	F13
	M16 x 2.0	14.0	K3D14020-05	F13
	M18 x 2.5	15.5	K3D15520-05	F13
	M20 x 2.5	17.5	K3D17525-06	F13
	M22 x 2.5	19.5	K3D19525-06	F13
	M24 x 3.0	21.0	K3D21025-07	F13
	M27 x 3.0	24.0	K3D24032-09	F13
	M30 x 3.5	26.5	K3D26532-09	F13
	M33 x 4.0	29.0	K3D29032-09	F13
	M36 x 4.0	32.0	K3D30032-11	F14
	M39 x 4.0	35.0	K3D35032-11	F14
	M42 x 4.5	37.5	K3D37540-13	F14
Inch	9/16-12 UNC	12.2	K3D12220-04	F13
	5/8-11 UNC	13.5	K3D13520-04	F13
	3/4-10 UNC	16.5	K3D16525-06	F13
	7/8-9 UNC	19.5	K3D19525-06	F13
	9/16-18 UNF	12.9	K3D12920-04	F13
	5/8-18 UNF	14.5	K3D14520-05	F13
	3/4-16 UNF	17.5	K3D17525-06	F13

Special drill order form



■ Coolant type

Through coolant Plug type (Standard) Through coolant Non plug type No coolant

■ Hole type

Blind hole Thru hole

■ Types of shank

Flat type

Weldon type

Whistle Notch type

■ Location of side lock

Parallel to peripheral insert (standard)

90° angle to peripheral insert (standard)

180° angle to peripheral insert (standard)

270° angle to peripheral insert (standard)

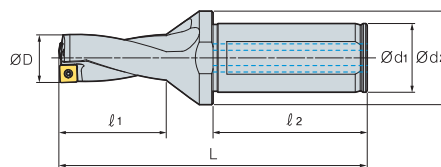
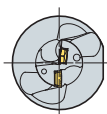
■ Note

- Currently using tool:
- Current cutting condition
 - RPM or vc (m/min):
 - vf (mm/min) or fn (mm/rev):
 - Depth of cut (mm):

- Standard of measuring tool life:
- Currently using machine
 - Machining center:
 - General lathe:
 - CNC lathe:



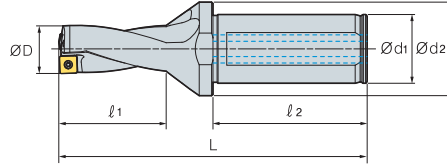
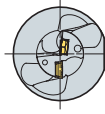
King Drill (2D)





Designation		ØD	Ød ₁	Ød ₂	l ₁	l ₂	L	Insert	Screw	Wrench
K2D	12020-04	12.0	20	25	27	50	91	SP□T040204-□□ XO□T040204-□□	FTNA0204	TW06P
	12520-04	12.5	20	25	27	50	91			
	13020-04	13.0	20	25	29	50	93			
	13520-04	13.5	20	25	29	50	93	SP□T050204-□□ XO□T050204-□□	FTNA0204	TW06P
	14020-05	14.0	20	25	31	50	96			
	14520-05	14.5	20	25	31	50	96			
	15020-05	15.0	20	25	33	50	99	SP□T060205-□□ XO□T060204-□□	FTKA02206S	TW07P
	15520-05	15.5	20	25	33	50	99			
	16020-05	16.0	20	25	35	50	101			
	16525-06	16.5	25	34	35	56	107	SP□T07T208-□□ XO□T07T205-□□	FTKA02565	TW07S
	17025-06	17.0	25	34	37	56	109			
	17525-06	17.5	25	34	37	56	109			
	18025-06	18.0	25	34	39	56	112	SP□T090308-□□ XO□T090305-□□	FTKA0307	TW09S
	18525-06	18.5	25	34	39	56	112			
	19025-06	19.0	25	34	41	56	114			
	19525-06	19.5	25	34	41	56	114	SP□T11T308-□□ XO□T11T306-□□	FTKA03508	TW15S
	20025-07	20.0	25	34	43	56	118			
	20525-07	20.5	25	34	43	56	118			
	21025-07	21.0	25	34	45	56	120	SP□T11T308-□□ XO□T11T306-□□	FTKA03508	TW15S
	21525-07	21.5	25	34	45	56	120			
	22025-07	22.0	25	34	47	56	122			
	22525-07	22.5	25	34	47	56	122	SP□T11T308-□□ XO□T11T306-□□	FTKA03508	TW15S
	23025-07	23.0	25	34	49	56	126			
	23525-07	23.5	25	34	49	56	126			
	24032-09	24.0	32	44	51	60	133	SP□T11T308-□□ XO□T11T306-□□	FTKA03508	TW15S
	24532-09	24.5	32	44	51	60	133			
	25032-09	25.0	32	44	53	60	135			
	25532-09	25.5	32	44	53	60	135	SP□T11T308-□□ XO□T11T306-□□	FTKA03508	TW15S
	26032-09	26.0	32	44	55	60	137			
	26532-09	26.5	32	44	55	60	137			
	27032-09	27.0	32	44	57	60	140	SP□T11T308-□□ XO□T11T306-□□	FTKA03508	TW15S
	27532-09	27.5	32	44	57	60	140			
	28032-09	28.0	32	44	59	60	143			
	28532-09	28.5	32	44	59	60	143	SP□T11T308-□□ XO□T11T306-□□	FTKA03508	TW15S
	29032-09	29.0	32	44	61	60	145			
29532-09	29.5	32	44	61	60	145				
30032-11	30.0	32	44	63	60	150	SP□T11T308-□□ XO□T11T306-□□	FTKA03508	TW15S	
30532-11	30.5	32	44	63	60	150				
31032-11	31.0	32	44	65	60	152				
31532-11	31.5	32	44	65	60	152	SP□T11T308-□□ XO□T11T306-□□	FTKA03508	TW15S	
32032-11	32.0	32	44	67	60	154				
32532-11	32.5	32	44	67	60	154				
33032-11	33.0	32	44	69	60	157	SP□T11T308-□□ XO□T11T306-□□	FTKA03508	TW15S	
33532-11	33.5	32	44	69	60	157				
34032-11	34.0	32	44	71	60	159				
34532-11	34.5	32	44	71	60	159	SP□T11T308-□□ XO□T11T306-□□	FTKA03508	TW15S	
35032-11	35.0	32	44	73	60	161				
35532-11	35.5	32	44	73	60	161				

↻ Applicable inserts F03~04

King Drill (2D)



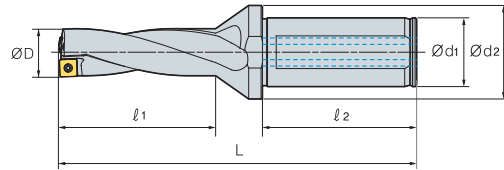
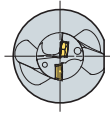
(mm)

Designation	ØD	Ød ₁	Ød ₂	l ₁	l ₂	L	Insert	Screw 	Wrench 
K2D									
36040-13	36.0	40	48	76	70	176	SP□T130410-□□ XO□T130406-□□	FTKA0410	TW15S
36540-13	36.5	40	48	76	70	176			
37040-13	37.0	40	48	78	70	178			
37540-13	37.5	40	48	78	70	178			
38040-13	38.0	40	48	80	70	181			
38540-13	38.5	40	48	80	70	181			
39040-13	39.0	40	48	82	70	183			
39540-13	39.5	40	48	82	70	183			
40040-13	40.0	40	48	84	70	186			
40540-13	40.5	40	48	84	70	186			
41040-13	41.0	40	48	86	70	188			
41540-13	41.5	40	48	86	70	188			
42040-13	42.0	40	48	88	70	191			
42540-13	42.5	40	48	88	70	191			
43040-15	43.0	40	58	91	70	196			
43540-15	43.5	40	58	91	70	196			
44040-15	44.0	40	58	93	70	198			
44540-15	44.5	40	58	93	70	198			
45040-15	45.0	40	58	95	70	201			
45540-15	45.5	40	58	95	70	201			
46040-15	46.0	40	58	97	70	203			
46540-15	46.5	40	58	97	70	203			
47040-15	47.0	40	58	99	70	206			
47540-15	47.5	40	58	99	70	206			
48040-15	48.0	40	58	101	70	208			
48540-15	48.5	40	58	101	70	208			
49040-15	49.0	40	58	103	70	210			
49540-15	49.5	40	58	103	70	210			
50040-15	50.0	40	58	105	70	212			
50540-15	50.5	40	58	105	70	212			
51040-18	51.0	40	68	108	70	218			
51540-18	51.5	40	68	108	70	218			
52040-18	52.0	40	68	110	70	220			
52540-18	52.5	40	68	110	70	220			
53040-18	53.0	40	68	112	70	222			
53540-18	53.5	40	68	112	70	222			
54040-18	54.0	40	68	114	70	224			
54540-18	54.5	40	68	114	70	224			
55040-18	55.0	40	68	116	70	226			
55540-18	55.5	40	68	116	70	226			
56040-18	56.0	40	68	118	70	230			
56540-18	56.5	40	68	118	70	230			
57040-18	57.0	40	68	121	70	233			
57540-18	57.5	40	68	121	70	233			
58040-18	58.0	40	68	124	70	236			
58540-18	58.5	40	68	124	70	236			
59040-18	59.0	40	68	127	70	239			
59540-18	59.5	40	68	127	70	239			
60040-18	60.0	40	68	130	70	242			
60540-18	60.5	40	68	130	70	242			
							SP□T15M510-□□ XO□T15M508-□□	FTNC04511	TW20S

Applicable inserts F03-04



King Drill (3D)



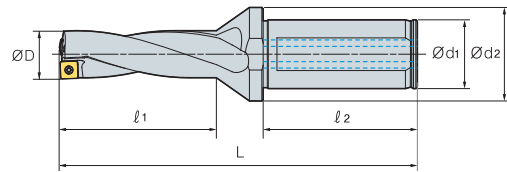
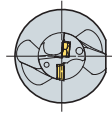
(mm)

Designation	ØD	Ød ₁	Ød ₂	ℓ ₁	ℓ ₂	L	Insert	Screw	Wrench	
K3D	12020-04 *	12.0	20	25	39	50	103	SP□T040204-□□ XO□T040204-□□	FTNA0204	TW06P
	12220-04	12.2	20	25	39	50	103			
	12520-04	12.5	20	25	39	50	103			
	12920-04	12.9	20	25	42	50	106			
	13020-04	13.0	20	25	42	50	106			
	13520-04	13.5	20	25	42	50	106			
	14020-05 *	14.0	20	25	45	50	110	SP□T050204-□□ XO□T050204-□□	FTNA0204	TW06P
	14520-05	14.5	20	25	45	50	110			
	15020-05	15.0	20	25	48	50	114			
	15520-05 *	15.5	20	25	48	50	114			
	16020-05	16.0	20	25	51	50	117			
	16525-06	16.5	25	34	51	56	123			
	17025-06	17.0	25	34	54	56	126			
	17525-06 *	17.5	25	34	54	56	126			
	18025-06	18.0	25	34	57	56	130			
	18525-06	18.5	25	34	57	56	130			
	19025-06	19.0	25	34	60	56	133			
	19525-06 *	19.5	25	34	60	56	133	SP□T07T208-□□ XO□T07T205-□□	FTKA02565	TW07S
	20025-07	20.0	25	34	63	56	138			
	20525-07	20.5	25	34	63	56	138			
21025-07 *	21.0	25	34	66	56	141				
21525-07	21.5	25	34	66	56	141				
22025-07	22.0	25	34	69	56	144				
22525-07	22.5	25	34	69	56	144	SP□T090308-□□ XO□T090305-□□	FTKA0307	TW09S	
23025-07	23	25	34	72	56	149				
23525-07	23.5	25	34	72	56	149				
24032-09 *	24.0	32	44	75	60	157				
24532-09	24.5	32	44	75	60	157				
25032-09	25.0	32	44	78	60	160				
25532-09	25.5	32	44	78	60	160	SP□T090308-□□ XO□T090305-□□	FTKA0307	TW09S	
26032-09	26.0	32	44	81	60	163				
26532-09 *	26.5	32	44	81	60	163				
27032-09	27.0	32	44	84	60	167				
27532-09	27.5	32	44	84	60	167				
28032-09	28.0	32	44	87	60	171				
28532-09	28.5	32	44	87	60	171	SP□T090308-□□ XO□T090305-□□	FTKA0307	TW09S	
29032-09 *	29.0	32	44	90	60	174				
29532-09	29.5	32	44	90	60	174				



↻ Applicable inserts **F03~04**

The items marked * can machine a tap foundation hole (Reference F09 page)

King Drill (3D)



(mm)

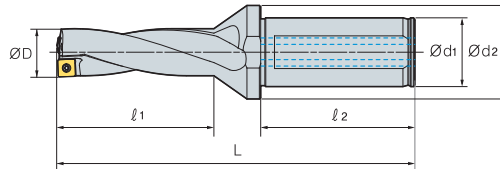
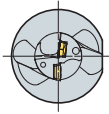
Designation	ØD	Ød ₁	Ød ₂	l ₁	l ₂	L	Insert	Screw 	Wrench 			
K3D 30032-11 *	30.0	32	44	93	60	180	SP□T11T308-□□ XO□T11T306-□□	FTKA03508	TW15S			
30532-11	30.5	32	44	93	60	180						
31032-11	31.0	32	44	96	60	183						
31532-11	31.5	32	44	96	60	183						
32032-11	32.0	32	44	99	60	186						
32532-11	32.5	32	44	99	60	186						
33032-11	33.0	32	44	102	60	190						
33532-11	33.5	32	44	102	60	190						
34032-11	34.0	32	44	105	60	193						
34532-11	34.5	32	44	105	60	193						
35032-11 *	35.0	32	44	108	60	196						
35532-11	35.5	32	44	108	60	196						
36040-13	36.0	40	48	112	70	212				SP□T130410-□□ XO□T130406-□□	FTKA0410	TW15S
36540-13	36.5	40	48	112	70	212						
37040-13	37.0	40	48	115	70	215						
37540-13	37.5	40	48	115	70	215						
38040-13	38.0	40	48	118	70	219						
38540-13	38.5	40	48	118	70	219						
39040-13	39.0	40	48	121	70	222						
39540-13	39.5	40	48	121	70	222						
40040-13	40.0	40	48	124	70	226						
40540-13	40.5	40	48	124	70	226						
41040-13	41.0	40	48	127	70	229						
41540-13	41.5	40	48	127	70	229						
42040-13	42.0	40	48	130	70	233						
42540-13	42.5	40	48	130	70	233						
43040-15	43.0	40	58	134	70	239	SP□T15M510-□□ XO□T15M508-□□	FTNC04511	TW20S			
43540-15	43.5	40	58	134	70	239						
44040-15	44.0	40	58	137	70	242						
44540-15	44.5	40	58	137	70	242						
45040-15	45.0	40	58	140	70	246						
45540-15	45.5	40	58	140	70	246						
46040-15	46.0	40	58	143	70	249						
46540-15	46.5	40	58	143	70	249						
47040-15	47.0	40	58	146	70	253						
47540-15	47.5	40	58	146	70	253						
48040-15	48.0	40	58	149	70	256						
48540-15	48.5	40	58	149	70	256						
49040-15	49.0	40	58	152	70	259						
49540-15	49.5	40	58	152	70	259						
50040-15	50.0	40	58	155	70	262						
50540-15	50.5	40	58	155	70	262						

↻ Applicable inserts F03~04

The items marked * can machine a tap foundation hole (Reference F09 page)



King Drill (3D)

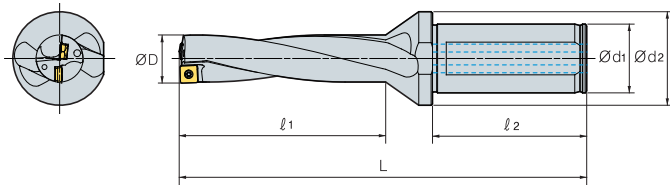


(mm)

Designation		ØD	Ød ₁	Ød ₂	l ₁	l ₂	L	Insert	Screw	Wrench
K3D	51040-18	51.0	40	68	159	70	269	SP□T180510-□□ XO□T180508-□□	FTNA0511	TW20-100
	51540-18	51.5	40	68	159	70	269			
	52040-18	52.0	40	68	162	70	272			
	52540-18	52.5	40	68	162	70	272			
	53040-18	53.0	40	68	165	70	275			
	53540-18	53.5	40	68	165	70	275			
	54040-18	54.0	40	68	168	70	278			
	54540-18	54.5	40	68	168	70	278			
	55040-18	55.0	40	68	171	70	281			
	55540-18	55.5	40	68	171	70	281			
	56040-18	56.0	40	68	174	70	286			
	56540-18	56.5	40	68	174	70	286			
	57040-18	57.0	40	68	178	70	290			
	57540-18	57.5	40	68	178	70	290			
	58040-18	58.0	40	68	182	70	294			
	58540-18	58.5	40	68	182	70	294			
	59040-18	59.0	40	68	186	70	298			
	59540-18	59.5	40	68	186	70	298			
	60040-18	60.0	40	68	190	70	302			
	60540-18	60.5	40	68	190	70	302			

↻ Applicable inserts F03~04

King Drill (4D)



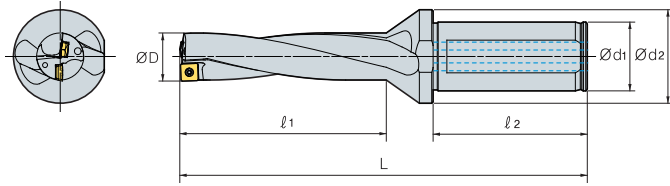
(mm)

Designation	ØD	Ød ₁	Ød ₂	l ₁	l ₂	L	Insert	Screw	Wrench	
K4D	12020-04	12.0	20	25	51	50	115	SP□T040204-□□ XO□T040204-□□	FTNA0204	TW06P
	12520-04	12.5	20	25	51	50	115			
	13020-04	13.0	20	25	55	50	119			
	13520-04	13.5	20	25	55	50	119	SP□T050204-□□ XO□T050204-□□	FTNA0204	TW06P
	14020-05	14.0	20	25	59	50	124			
	14520-05	14.5	20	25	59	50	124			
	15020-05	15.0	20	25	63	50	129	SP□T060205-□□ XO□T060204-□□	FTKA02206S	TW07P
	15520-05	15.5	20	25	63	50	129			
	16020-05	16.0	20	25	67	50	133			
	16525-06	16.5	25	34	67	56	139	SP□T07T208-□□ XO□T07T205-□□	FTKA02565	TW07S
	17025-06	17.0	25	34	71	56	143			
	17525-06	17.5	25	34	71	56	143			
	18025-06	18.0	25	34	75	56	148	SP□T090308-□□ XO□T090305-□□	FTKA0307	TW09S
	18525-06	18.5	25	34	75	56	148			
	19025-06	19.0	25	34	79	56	152			
	19525-06	19.5	25	34	79	56	152	SP□T11T308-□□ XO□T11T306-□□	FTKA03508	TW15S
	20025-07	20.0	25	34	83	56	158			
	20525-07	20.5	25	34	83	56	158			
	21025-07	21.0	25	34	87	56	162	SP□T11T308-□□ XO□T11T306-□□	FTKA03508	TW15S
	21525-07	21.5	25	34	87	56	162			
	22025-07	22.0	25	34	91	56	166			
	22525-07	22.5	25	34	91	56	166	SP□T11T308-□□ XO□T11T306-□□	FTKA03508	TW15S
	23025-07	23.0	25	34	95	56	172			
	23525-07	23.5	25	34	95	56	172			
	24032-09	24.0	32	44	99	60	181	SP□T11T308-□□ XO□T11T306-□□	FTKA03508	TW15S
	24532-09	24.5	32	44	99	60	181			
	25032-09	25.0	32	44	103	60	185			
	25532-09	25.5	32	44	103	60	185	SP□T11T308-□□ XO□T11T306-□□	FTKA03508	TW15S
	26032-09	26.0	32	44	107	60	189			
	26532-09	26.5	32	44	107	60	189			
	27032-09	27.0	32	44	111	60	194	SP□T11T308-□□ XO□T11T306-□□	FTKA03508	TW15S
	27532-09	27.5	32	44	111	60	194			
	28032-09	28.0	32	44	115	60	199			
28532-09	28.5	32	44	115	60	199	SP□T11T308-□□ XO□T11T306-□□	FTKA03508	TW15S	
29032-09	29.0	32	44	119	60	203				
29532-09	29.5	32	44	119	60	203				
30032-11	30.0	32	44	123	60	210	SP□T11T308-□□ XO□T11T306-□□	FTKA03508	TW15S	
30532-11	30.5	32	44	123	60	210				
31032-11	31.0	32	44	127	60	214				
31532-11	31.5	32	44	127	60	214	SP□T11T308-□□ XO□T11T306-□□	FTKA03508	TW15S	
32032-11	32.0	32	44	131	60	218				
32532-11	32.5	32	44	131	60	218				
33032-11	33.0	32	44	135	60	223	SP□T11T308-□□ XO□T11T306-□□	FTKA03508	TW15S	
33532-11	33.5	32	44	135	60	223				
34032-11	34.0	32	44	139	60	227				
34532-11	34.5	32	44	139	60	227	SP□T11T308-□□ XO□T11T306-□□	FTKA03508	TW15S	
35032-11	35.0	32	44	143	60	231				
35532-11	35.5	32	44	143	60	231				

↻ Applicable inserts F03-04



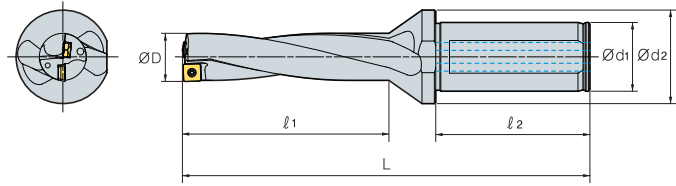
King Drill (4D)



Designation		ØD	Ød ₁	Ød ₂	l ₁	l ₂	L	Insert	Screw	Wrench
K4D	36040-13	36.0	40	48	148	70	248	SP□T130410-□□ XO□T130406-□□	FTKA0410	TW15S
	36540-13	36.5	40	48	148	70	248			
	37040-13	37.0	40	48	152	70	252			
	37540-13	37.5	40	48	152	70	252			
	38040-13	38.0	40	48	156	70	257			
	38540-13	38.5	40	48	156	70	257			
	39040-13	39.0	40	48	160	70	261			
	39540-13	39.5	40	48	160	70	261			
	40040-13	40.0	40	48	164	70	266			
	40540-13	40.5	40	48	164	70	266			
	41040-13	41.0	40	48	168	70	270			
	41540-13	41.5	40	48	168	70	270			
	42040-13	42.0	40	48	172	70	275			
	42540-13	42.5	40	48	172	70	275			
	43040-15	43.0	40	58	177	70	282			
	43540-15	43.5	40	58	177	70	282			
	44040-15	44.0	40	58	181	70	286			
	44540-15	44.5	40	58	181	70	286			
	45040-15	45.0	40	58	185	70	291			
	45540-15	45.5	40	58	185	70	291			
	46040-15	46.0	40	58	189	70	295			
	46540-15	46.5	40	58	189	70	295			
	47040-15	47.0	40	58	193	70	300			
	47540-15	47.5	40	58	193	70	300			
	48040-15	48.0	40	58	197	70	304			
	48540-15	48.5	40	58	197	70	304			
	49040-15	49.0	40	58	201	70	308			
	49540-15	49.5	40	58	201	70	308			
50040-15	50.0	40	58	205	70	312				
50540-15	50.5	40	58	205	70	312				
51040-18	51.0	40	68	210	70	320				
51540-18	51.5	40	68	210	70	320				
52040-18	52.0	40	68	214	70	324				
52540-18	52.5	40	68	214	70	324				
53040-18	53.0	40	68	218	70	328				
53540-18	53.5	40	68	218	70	328				
54040-18	54.0	40	68	222	70	332				
54540-18	54.5	40	68	222	70	332				
55040-18	55.0	40	68	226	70	336				
55540-18	55.5	40	68	226	70	336				
56040-18	56.0	40	68	230	70	342				
56540-18	56.5	40	68	230	70	342				
57040-18	57.0	40	68	235	70	347				
57540-18	57.5	40	68	235	70	347				
58040-18	58.0	40	68	240	70	352				
58540-18	58.5	40	68	240	70	352				
59040-18	59.0	40	68	245	70	357				
59540-18	59.5	40	68	245	70	357				
60040-18	60.0	40	68	250	70	362				
60540-18	60.5	40	68	250	70	362				

→ Applicable inserts F03~04

King Drill (5D)



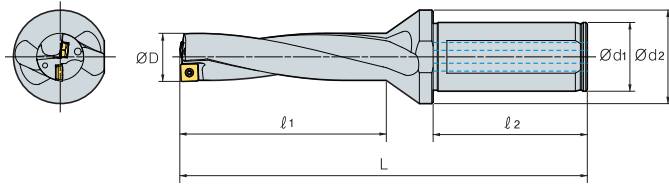
(mm)

Designation	ØD	Ød ₁	Ød ₂	l ₁	l ₂	L	Insert	Screw	Wrench
K5D									
12020-04	12.0	20	25	63	50	127	SP□T040204-□□ XO□T040204-□□	FTNA0204	TW06P
12520-04	12.5	20	25	63	50	127			
13020-04	13.0	20	25	68	50	132	SP□T050204-□□ XO□T050204-□□	FTNA0204	TW06P
13520-04	13.5	20	25	68	50	132			
14020-05	14.0	20	25	73	50	138	SP□T060205-□□ XO□T060204-□□	FTKA02206S	TW07P
14520-05	14.5	20	25	73	50	138			
15020-05	15.0	20	25	78	50	144	SP□T07T208-□□ XO□T07T205-□□	FTKA02565	TW07S
15520-05	15.5	20	25	78	50	144			
16020-05	16.0	20	25	83	50	149	SP□T090308-□□ XO□T090305-□□	FTKA0307	TW09S
16525-06	16.5	25	34	83	56	155			
17025-06	17.0	25	34	88	56	160	SP□T11T308-□□ XO□T11T306-□□	FTKA03508	TW15S
17525-06	17.5	25	34	88	56	160			
18025-06	18.0	25	34	93	56	166	SP□T11T308-□□ XO□T11T306-□□	FTKA03508	TW15S
18525-06	18.5	25	34	93	56	166			
19025-06	19.0	25	34	98	56	171	SP□T11T308-□□ XO□T11T306-□□	FTKA03508	TW15S
19525-06	19.5	25	34	98	56	171			
20025-07	20.0	25	34	103	56	178	SP□T11T308-□□ XO□T11T306-□□	FTKA03508	TW15S
20525-07	20.5	25	34	103	56	178			
21025-07	21.0	25	34	108	56	183	SP□T11T308-□□ XO□T11T306-□□	FTKA03508	TW15S
21525-07	21.5	25	34	108	56	183			
22025-07	22.0	25	34	113	56	188	SP□T11T308-□□ XO□T11T306-□□	FTKA03508	TW15S
22525-07	22.5	25	34	113	56	188			
23025-07	23.0	25	34	118	56	195	SP□T11T308-□□ XO□T11T306-□□	FTKA03508	TW15S
23525-07	23.5	25	34	118	56	195			
24032-09	24.0	32	44	123	60	205	SP□T11T308-□□ XO□T11T306-□□	FTKA03508	TW15S
24532-09	24.5	32	44	123	60	205			
25032-09	25.0	32	44	128	60	210	SP□T11T308-□□ XO□T11T306-□□	FTKA03508	TW15S
25532-09	25.5	32	44	128	60	210			
26032-09	26.0	32	44	133	60	215	SP□T11T308-□□ XO□T11T306-□□	FTKA03508	TW15S
26532-09	26.5	32	44	133	60	215			
27032-09	27.0	32	44	138	60	221	SP□T11T308-□□ XO□T11T306-□□	FTKA03508	TW15S
27532-09	27.5	32	44	138	60	221			
28032-09	28.0	32	44	143	60	227	SP□T11T308-□□ XO□T11T306-□□	FTKA03508	TW15S
28532-09	28.5	32	44	143	60	227			
29032-09	29.0	32	44	148	60	232	SP□T11T308-□□ XO□T11T306-□□	FTKA03508	TW15S
29532-09	29.5	32	44	148	60	232			
30032-11	30.0	32	44	153	60	240	SP□T11T308-□□ XO□T11T306-□□	FTKA03508	TW15S
30532-11	30.5	32	44	153	60	240			
31032-11	31.0	32	44	158	60	245	SP□T11T308-□□ XO□T11T306-□□	FTKA03508	TW15S
31532-11	31.5	32	44	158	60	245			
32032-11	32.0	32	44	163	60	250	SP□T11T308-□□ XO□T11T306-□□	FTKA03508	TW15S
32532-11	32.5	32	44	163	60	250			
33032-11	33.0	32	44	168	60	256	SP□T11T308-□□ XO□T11T306-□□	FTKA03508	TW15S
33532-11	33.5	32	44	168	60	256			
34032-11	34.0	32	44	173	60	261	SP□T11T308-□□ XO□T11T306-□□	FTKA03508	TW15S
34532-11	34.5	32	44	173	60	261			
35032-11	35.0	32	44	178	60	266	SP□T11T308-□□ XO□T11T306-□□	FTKA03508	TW15S
35532-11	35.5	32	44	178	60	266			

↻ Applicable inserts F03-04



King Drill (5D)



Designation		ØD	Ød ₁	Ød ₂	l ₁	l ₂	L	Insert	Screw	Wrench
K5D	36040-13	36.0	40	48	184	70	284	SP□T130410-□□ XO□T130406-□□	FTKA0410	TW15S
	36540-13	36.5	40	48	184	70	284			
	37040-13	37.0	40	48	189	70	289			
	37540-13	37.5	40	48	189	70	289			
	38040-13	38.0	40	48	194	70	295			
	38540-13	38.5	40	48	194	70	295			
	39040-13	39.0	40	48	199	70	300			
	39540-13	39.5	40	48	199	70	300			
	40040-13	40.0	40	48	204	70	306			
	40540-13	40.5	40	48	204	70	306			
	41040-13	41.0	40	48	209	70	311			
	41540-13	41.5	40	48	209	70	311			
	42040-13	42.0	40	48	214	70	317			
	42540-13	42.5	40	48	214	70	317			
	43040-15	43.0	40	58	220	70	325			
	43540-15	43.5	40	58	221	70	326			
	44040-15	44.0	40	58	225	70	330			
	44540-15	44.5	40	58	225	70	330			
	45040-15	45.0	40	58	230	70	336			
	45540-15	45.5	40	58	230	70	336			
	46040-15	46.0	40	58	235	70	341			
	46540-15	46.5	40	58	235	70	341			
	47040-15	47.0	40	58	240	70	347			
	47540-15	47.5	40	58	240	70	347			
	48040-15	48.0	40	58	245	70	352			
	48540-15	48.5	40	58	245	70	352			
	49040-15	49.0	40	58	250	70	357			
	49540-15	49.5	40	58	250	70	357			
	50040-15	50.0	40	58	255	70	362			
	50540-15	50.5	40	58	255	70	362			
	51040-18	51.0	40	68	261	70	371			
	51540-18	51.5	40	68	261	70	371			
	52040-18	52.0	40	68	266	70	376			
52540-18	52.5	40	68	266	70	376				
53040-18	53.0	40	68	271	70	381				
53540-18	53.5	40	68	271	70	381				
54040-18	54.0	40	68	276	70	386				
54540-18	54.5	40	68	276	70	386				
55040-18	55.0	40	68	281	70	391				
55540-18	55.5	40	68	281	70	391				
56040-18	56.0	40	68	286	70	398				
56540-18	56.5	40	68	286	70	398				
57040-18	57.0	40	68	292	70	404				
57540-18	57.5	40	68	292	70	404				
58040-18	58.0	40	68	298	70	410				
58540-18	58.5	40	68	298	70	410				
59040-18	59.0	40	68	304	70	416				
59540-18	59.5	40	68	304	70	416				
60040-18	60.0	40	68	310	70	422				
60540-18	60.5	40	68	310	70	422				

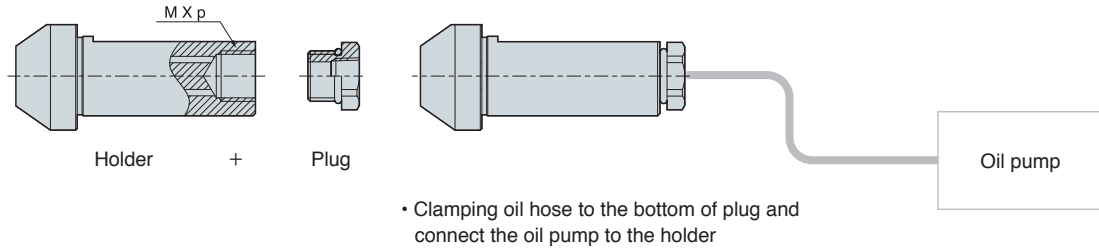
→ Applicable inserts F03~04

F Technical Information for King Drill (For through coolant system with a lathe)

Drill with through coolant system for general lathe and
CNC lathe without through coolant system

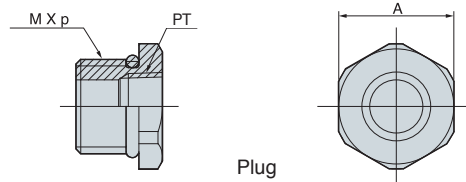
King Drill (For through coolant system with a lathe)

- Through coolant system with drill holder, plug, oil-hole hose and oil-hole pump
- PT TAP in the plug is combined to PT TAP connected to oil hose
- Available to use the drill without a plug in milling machine



(mm)

Tap type	Diameter	Shank dia.	M x p	Plug
K□D120~16020HP-□□	Ø12.0~Ø16.0	Ø20	M12x1.5	PLG12PT18
K□D161~23525HP-□□	Ø16.1~Ø23.5	Ø25	M16x1.5	PLG16PT18
K□D236~35532HP-□□	Ø23.6~Ø35.5	Ø32	M20x2.0	PLG20PT14
K□D356~60940HP-□□	Ø35.6~Ø60.5	Ø40	M27x2.0	PLG27PT38



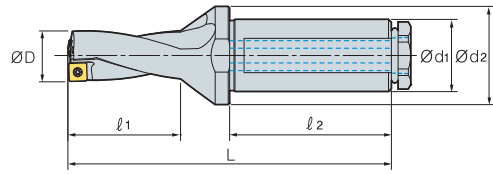
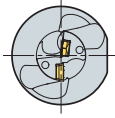
• Plug is assembled

Plug type	M x p	PT tap	A
PLG12PT18	M12 x 1.5	1/8	16
PLG16PT18	M16 x 1.5	1/8	19
PLG20PT14	M20 x 2.0	1/4	26
PLG27PT38	M27 x 2.0	3/8	35



King Drill (2D)

For through coolant system with a lathe



(mm)

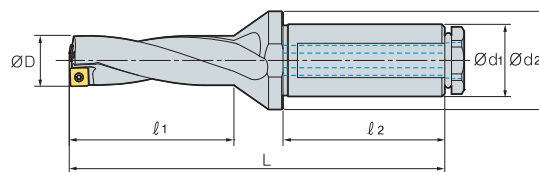
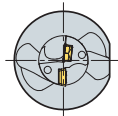
Designation	ØD	Ød ₁	Ød ₂	l ₁	l ₂	L	Insert	Screw	Wrench	
K2D	13020HP-04	13.0	20	25	29	50	93	SP□T040204-□□	FTNA0204	TW06P
	13520HP-04	13.5	20	25	29	50	93	XO□T040204-□□		
	14020HP-05	14.0	20	25	31	50	96	SP□T050204-□□	FTNA0204	TW06P
	15020HP-05	15.0	20	25	33	50	99	XO□T050204-□□		
	16020HP-05	16.0	20	25	35	50	101			
	17025HP-06	17.0	25	34	37	56	109	SP□T060205-□□	FTKA02206S	TW07P
	18025HP-06	18.0	25	34	39	56	112	XO□T060204-□□		
	19025HP-06	19.0	25	34	41	56	114			
	20025HP-07	20.0	25	34	43	56	118			
	21025HP-07	21.0	25	34	45	56	120	SP□T07T208-□□	FTKA02565	TW07S
	22025HP-07	22.0	25	34	47	56	122	XO□T07T205-□□		
	23025HP-07	23.0	25	34	49	56	126			
	24032HP-09	24.0	32	44	51	60	133			
	25032HP-09	25.0	32	44	53	60	135			
	26032HP-09	26.0	32	44	55	60	137	SP□T090308-□□	FTKA0307	TW09S
	27032HP-09	27.0	32	44	57	60	140	XO□T090305-□□		
	28032HP-09	28.0	32	44	59	60	143			
	29032HP-09	29.0	32	44	61	60	145			

↻ Applicable inserts **F03~04**

F King Drill (For through coolant system with a lathe)

King Drill (3D)

For through coolant system with a lathe



(mm)

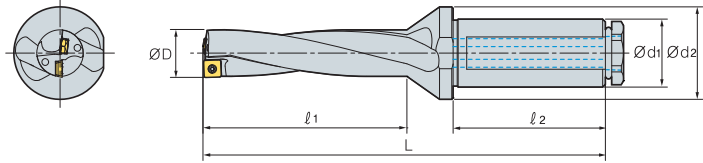
Designation	ØD	Ød ₁	Ød ₂	l ₁	l ₂	L	Insert	Screw	Wrench	
K3D	13020HP-04	13.0	20	25	42	50	106	SP□T040204-□□	FTNA0204	TW06P
	13520HP-04	13.5	20	25	42	50	106	XO□T040204-□□		
	14020HP-05	14.0	20	25	45	50	110			
	14520HP-05	14.5	20	25	45	50	110	SP□T050204-□□ XO□T050204-□□	FTNA0204	TW06P
	15020HP-05	15.0	20	25	48	50	114			
	15520HP-05	15.5	20	25	48	50	114			
	16020HP-05	16.0	20	25	51	50	117			
	16525HP-06	16.5	25	34	51	56	123			
	17025HP-06	17.0	25	34	54	56	126	SP□T060205-□□ XO□T060204-□□	FTKA02206S	TW07P
	17525HP-06	17.5	25	34	54	56	126			
	18025HP-06	18.0	25	34	57	56	130			
	18525HP-06	18.5	25	34	57	56	130			
	19025HP-06	19.0	25	34	60	56	133			
	19525HP-06	19.5	25	34	60	56	133	SP□T07T208-□□ XO□T07T205-□□	FTKA02565	TW07S
	20025HP-07	20.0	25	34	63	56	138			
	20525HP-07	20.5	25	34	63	56	138			
	21025HP-07	21.0	25	34	66	56	141			
	21525HP-07	21.5	25	34	66	56	141			
	22025HP-07	22.0	25	34	69	56	144			
	22525HP-07	22.5	25	34	69	56	144			
	23025HP-07	23.0	25	34	72	56	149	SP□T090308-□□ XO□T090305-□□	FTKA0307	TW09S
	23525HP-07	23.5	25	34	72	56	149			
	24032HP-09	24.0	32	44	75	60	157			
	24532HP-09	24.5	32	44	75	60	157			
	25032HP-09	25.0	32	44	78	60	160			
	25532HP-09	25.5	32	44	78	60	160			
	26032HP-09	26.0	32	44	81	60	163			
	26532HP-09	26.5	32	44	81	60	163			
	27032HP-09	27.0	32	44	84	60	167			
	27532HP-09	27.5	32	44	84	60	167			
	28032HP-09	28.0	32	44	87	60	171			
	28532HP-09	28.5	32	44	87	60	171			
	29032HP-09	29.0	32	44	90	60	174			
	29532HP-09	29.5	32	44	90	60	174			

↻ Applicable inserts F03-04



King Drill (4D)

For through coolant system with a lathe



Designation		ØD	Ød ₁	Ød ₂	l ₁	l ₂	L	Insert	Screw	Wrench
K4D	13020HP-04	13.0	20	25	55	50	119	SP□T040204-□□ XO□T040204-□□	FTNA0204	TW06P
	13520HP-04	13.5	20	25	55	50	119			
	14020HP-05	14.0	20	25	59	50	124	SP□T050204-□□ XO□T050204-□□	FTNA0204	TW06P
	15020HP-05	15.0	20	25	63	50	129			
	16020HP-05	16.0	20	25	67	50	133	SP□T060205-□□ XO□T060204-□□	FTKA02206S	TW07P
	17025HP-06	17.0	25	34	71	56	143			
	18025HP-06	18.0	25	34	75	56	148	SP□T07T208-□□ XO□T07T205-□□	FTKA02565	TW07S
	19025HP-06	19.0	25	34	79	56	152			
	20025HP-07	20.0	25	34	83	56	158	SP□T090308-□□ XO□T090305-□□	FTKA0307	TW09S
	21025HP-07	21.0	25	34	87	56	162			
	22025HP-07	22.0	25	34	91	56	166	SP□T090308-□□ XO□T090305-□□	FTKA0307	TW09S
	23025HP-07	23.0	25	34	95	56	172			
	24032HP-09	24.0	32	44	99	60	181	SP□T090308-□□ XO□T090305-□□	FTKA0307	TW09S
	25032HP-09	25.0	32	44	103	60	185			
	26032HP-09	26.0	32	44	107	60	189	SP□T090308-□□ XO□T090305-□□	FTKA0307	TW09S
	27032HP-09	27.0	32	44	111	60	194			
	28032HP-09	28.0	32	44	115	60	199	SP□T090308-□□ XO□T090305-□□	FTKA0307	TW09S
	29032HP-09	29.0	32	44	119	60	203			

➔ Applicable inserts F03~04

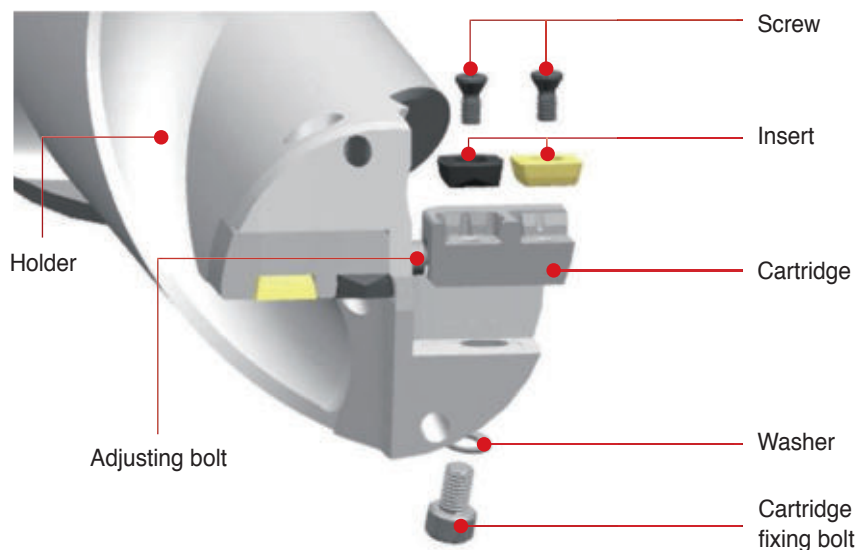
F Technical Information for King Drill (For large diameter drilling)

High rigidity drill produces cost efficiency due to cartridge replacement

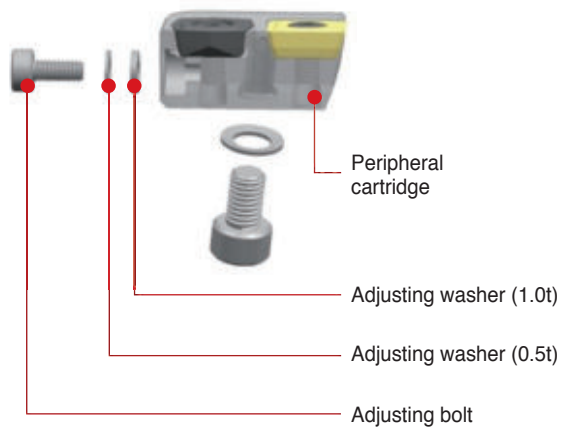
King Drill (For large diameter drilling)

- Cartridge type for $\text{Ø}61\sim\text{Ø}100$ drilling
- Peripheral cartridge can adjust the drilling diameter within 5 mm
- Easy to adjust drilling diameter with adjusting bolt

Structure of King Drill (for large diameter) parts



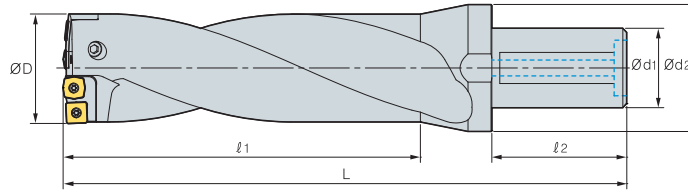
Adjustment of drill diameter



Adjustment Ø (mm)	Adjusting washer	
	Designation	Width (mm)
1	WA0305	0.5
2	WA0310	1.0
3	WA0305 + WA0310	1.5
4	WA0310 x 2	2.0
5	WA0305 + WA0310 x 2	2.5

※ Adjusting washer adjusts the drilling diameter within 5 mm

King Drill



(mm)

Designation	ØD	Ød ₁	Ød ₂	ℓ ₁	ℓ ₂	L	Cartridge		Screw	Wrench	
							Internal	External			
K2D	616550-11	61~65	50	80	130	80	255	KDC6165C	KDC6165P	FTKA03508	TW15S
	657050-13	65~70	50	88	140	80	265	KDC6570C	KDC6570P	FTKA0410	TW15S
	707550-13	70~75	50	88	150	80	275	KDC7075C	KDC7075P	FTKA0410	TW15S
	758050-13	75~80	50	88	160	80	285	KDC7580C	KDC7580P	FTKA0410	TW15S
	808550-15	80~85	50	88	170	80	295	KDC8085C	KDC8085P	FTNC04511	TW20S
	859050-15	85~90	50	95	180	80	305	KDC8590C	KDC8590P	FTNC04511	TW20S
	909550-15	90~95	50	95	190	80	315	KDC9095C	KDC9095P	FTNC04511	TW20S
	9510050-18	95~100	50	95	200	80	325	KDC95100C	KDC95100P	FTNA0511	TW20-100
K3D	616550-11	61~65	50	80	195	80	320	KDC6165C	KDC6165P	FTKA03508	TW15S
	657050-13	65~70	50	88	210	80	335	KDC6570C	KDC6570P	FTKA0410	TW15S
	707550-13	70~75	50	88	225	80	350	KDC7075C	KDC7075P	FTKA0410	TW15S
	758050-13	75~80	50	88	240	80	365	KDC7580C	KDC7580P	FTKA0410	TW15S
	808550-15	80~85	50	88	255	80	380	KDC8085C	KDC8085P	FTNC04511	TW20S
	859050-15	85~90	50	95	270	80	395	KDC8590C	KDC8590P	FTNC04511	TW20S
	909550-15	90~95	50	95	285	80	410	KDC9095C	KDC9095P	FTNC04511	TW20S
	9510050-18	95~100	50	95	300	80	425	KDC95100C	KDC95100P	FTNA0511	TW20-100
K4D	616550-11	61~65	50	80	260	80	385	KDC6165C	KDC6165P	FTKA03508	TW15S
	657050-13	65~70	50	88	280	80	405	KDC6570C	KDC6570P	FTKA0410	TW15S
	707550-13	70~75	50	88	300	80	425	KDC7075C	KDC7075P	FTKA0410	TW15S
	758050-13	75~80	50	88	320	80	445	KDC7580C	KDC7580P	FTKA0410	TW15S
	808550-15	80~85	50	88	340	80	465	KDC8085C	KDC8085P	FTNC04511	TW20S
	859050-15	85~90	50	95	360	80	485	KDC8590C	KDC8590P	FTNC04511	TW20S
	909550-15	90~95	50	95	380	80	505	KDC9095C	KDC9095P	FTNC04511	TW20S
	9510050-18	95~100	50	95	400	80	525	KDC95100C	KDC95100P	FTNA0511	TW20-100

↻ Applicable inserts **F03~04**

Parts

Cartridge		Range (Ø)	Insert				Screw	Wrench
Internal	External		Designation	Quantity	Designation	Quantity		
KDC6165C	KDC6165P	61~65	XO□T11T306-□□	2	SP□T11T308-□□	2	FTKA03508	TW15S
KDC6570C	KDC6570P	65~70	XO□T130406-□□	2	SP□T130410-□□	2	FTKA0410	TW15S
KDC7075C	KDC7075P	70~75	XO□T130406-□□	2	SP□T130410-□□	2	FTKA0410	TW15S
KDC7580C	KDC7580P	75~80	XO□T130406-□□	2	SP□T130410-□□	2	FTKA0410	TW15S
KDC8085C	KDC8085P	80~85	XO□T15M508-□□	2	SP□T15M510-□□	2	FTNC04511	TW20S
KDC8590C	KDC8590P	85~90	XO□T15M508-□□	2	SP□T15M510-□□	2	FTNC04511	TW20S
KDC9095C	KDC9095P	90~95	XO□T15M508-□□	2	SP□T15M510-□□	2	FTNC04511	TW20S
KDC95100C	KDC95100P	95~100	XO□T180508-□□	2	SP□T180510-□□	2	FTNA0511	TW20-100

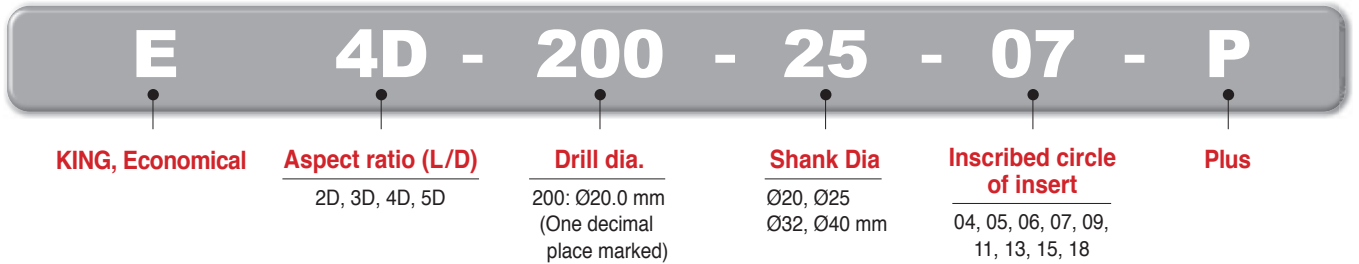
F Technical Information for KED Plus Drill

KORLOY indexable new generation economical drill

KED Plus Drill new

- Economical drill with good chip control due to optimal chip flute enlarging the space for chip flow
- Stable machining due to optimal shape and cutting edge arrangement of central and peripheral inserts

Code system



Features

- Excellent chip control for suitable cutting range with small diameters (Ø12-Ø23.5) due to the cutting fluid system and chip flute
- Excellent surface finish for suitable cutting range with medium to large diameters (Ø24-Ø60.5) due to widened chip pockets even in deep drilling
- Increased the rigidity of drill body and improved chip evacuation due to optimized shape of flute



Features of chip breaker

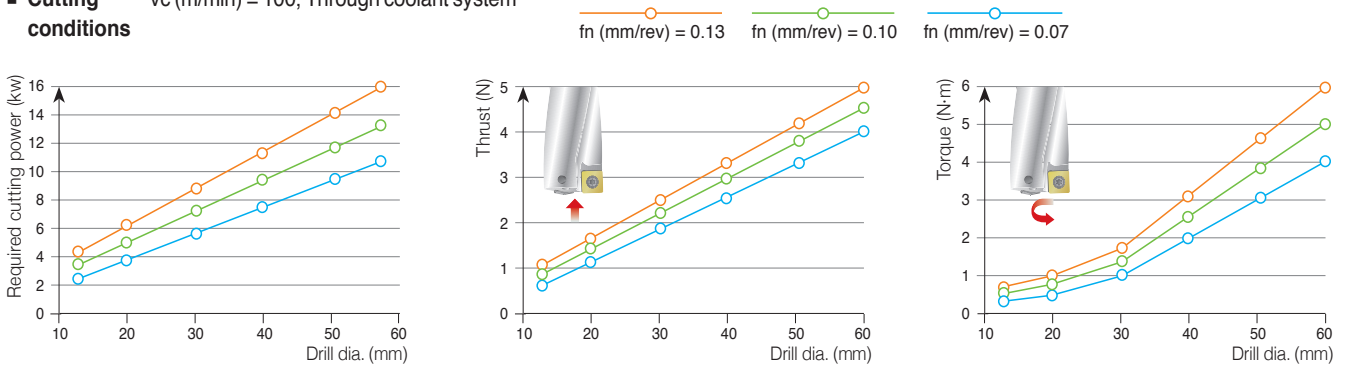
- **Optimized design of inserts for maximum drilling efficiency**
 - Excellent cutting performance and chip control due to the optimized geometry and chip breaker of both inserts: central and peripheral
 - A set of differently shaped central and peripheral inserts optimizing the insert locations in order to maximize cutting tool life

Chip breaker	PD		LD		ND		RD
Features	- Universal - At medium speed and medium feed		- Superior chip control for machining mild steel and stainless steel - Light cutting (at low~medium speed and low feed)		- Sharp cutting edge for aluminum machining - Insert surface buffed for high quality result - E Class Tolerance		- Improved chipping resistance - Excellent performance in case of frequent fracture and chipping on the cutting edge
Insert	Peripheral insert	Central insert	Peripheral insert	Central insert	Peripheral insert	Central insert	Central insert
Shape							
Grades for workpiece	NC5330: P, M, K PC3700: P PC5300: P, M, K, S PC6510: K PC9540: P, M, S		PC5335: P, M		H01: N		PC5300: P, M, K, S



Required cutting power

- Workpiece SCM440 (240HB)
- Cutting vc (m/min) = 100, Through coolant system conditions

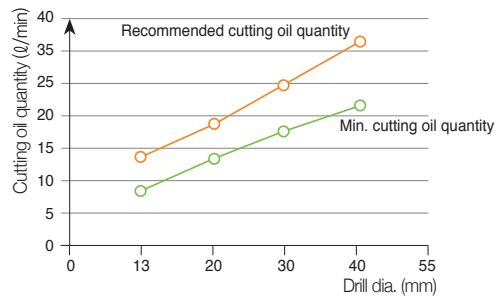


※ Cutting force shown as the above is base on drilling in facilities with enough rigidity and power

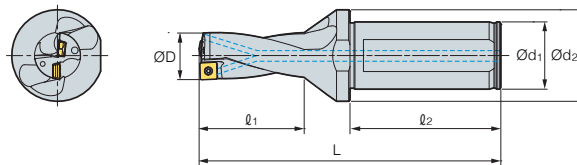
Cutting oil quantity

- Workpiece SCM440 (240HB)
- Cutting vc (m/min) = 100, Through coolant system conditions

• The data of the graph above could be changed depending on workpiece and cutting condition



Drill tolerance and hole tolerance

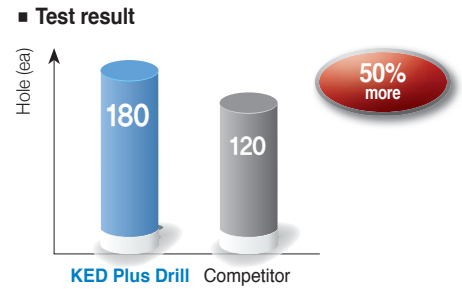


Drill dia.		Ø12~Ø29	Ø30~Ø45	Ø46~Ø60.5
2D~3D	Drill tolerance (ØD)	0~-0.15	0~-0.15	0~-0.15
	Hole tolerance	+0.2~-0.1	+0.25~-0.1	+0.28~-0.1
4D~5D	Drill tolerance (ØD)	0~-0.15	0~-0.15	0~-0.15
	Hole tolerance	+0.25~-0.05	+0.3~-0.05	+0.33~-0.05

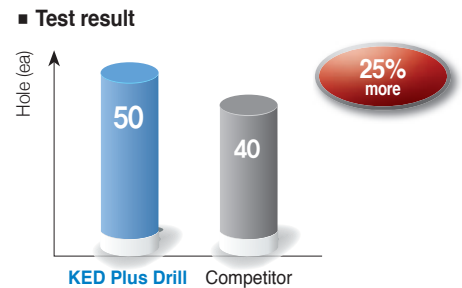
F Technical Information for KED Plus Drill

Application examples

- **Workpiece** Carbon steel (SM440)
- **Cutting conditions** vc (m/min) = 150, fn (mm/rev) = 0.1
ap (mm) = 80 (through hole), wet
- **Tools** **Inserts** SPMT060205-PD (PC3700)
XOMT060205-PD (PC5300)
Holder E4D-18025-06-P
(Drill dia. = Ø18 mm)



- **Workpiece** Stainless steel (STS316)
- **Cutting conditions** vc (m/min) = 120, fn (mm/rev) = 0.06
ap (mm) = 42, wet
- **Tools** **Inserts** SPMT060205-PD (PC3700)
XOMT060204-PD (PC3500)
Holder E3D-18025-06-P
(Drill dia. = Ø18 mm)



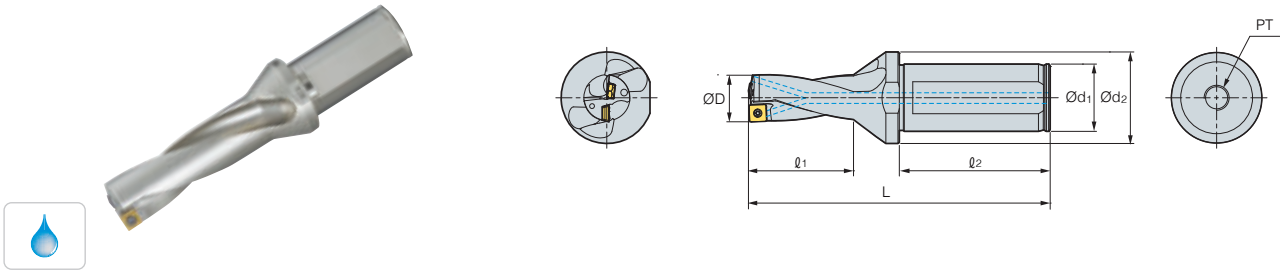
Recommended cutting condition

Workpiece			Insert			vc (m/min)	Aspect ratio (L/D) = 2D, 3D, 4D					
ISO	Workpiece	Hardness (HB)	Chip breaker	Grade			Feed rate (mm/rev) per drill dia. (mm)					
				Central	Peripheral		Ø12~Ø16	Ø17~Ø23	Ø24~Ø29	Ø30~Ø42	Ø43~Ø60	
P	Carbon steel	80~180	LD	PC5335	PC5335	120 (60~170)	0.04~0.08	0.04~0.08	0.04~0.08	0.04~0.08	0.04~0.08	
			PD/RD	PC5300	PC3500	150 (120~180)						
					NC5330	180 (140~220)						
	High carbon steel	180~280	PD	PC5300	PC3500	120 (90~150)	0.04~0.10	0.04~0.12	0.05~0.16	0.06~0.16	0.06~0.18	
					NC5330	150 (110~190)	0.04~0.06	0.04~0.07	0.04~0.08	0.04~0.08	0.04~0.08	
Alloy steel	Low alloy steel	140~260	LD	PC5335	PC5335	120 (60~160)	0.06~0.10	0.06~0.10	0.06~0.12	0.06~0.14	0.06~0.14	
			PD	PC5300	PC3500	150 (120~170)	0.06~0.12	0.06~0.12	0.06~0.14	0.06~0.16	0.06~0.16	
	NC5330	180 (140~210)			0.06~0.08	0.06~0.08	0.06~0.10	0.06~0.12	0.06~0.12			
	Low alloy heat-treated steel	200~400	PD	PC5300	PC5300	100 (50~150)	0.04~0.10	0.06~0.10	0.06~0.12	0.06~0.14	0.06~0.14	
	High alloy steel	260~320	PD	PC5300	PC3500	100 (50~160)	0.05~0.11	0.05~0.11	0.05~0.13	0.05~0.15	0.05~0.15	
High alloy heat-treated steel	300~450	PD	PC5300	PC5300	70 (30~120)	0.04~0.08	0.06~0.08	0.06~0.10	0.06~0.12	0.06~0.12		
M	Stainless steel	135~275	LD	PD5335	PC5335	120 (80~140)	0.04~0.07	0.04~0.07	0.04~0.07	0.04~0.08	0.04~0.08	
			PD	PC5300	PC5300	130 (100~160)	0.04~0.07	0.04~0.07	0.04~0.07	0.04~0.08	0.04~0.08	
				PC9540	PC9540	90 (60~120)	0.04~0.07	0.04~0.07	0.04~0.07	0.04~0.08	0.04~0.08	
K	Cast iron	150~230	PD	PC5300	PC6510	190 (150~250)	0.04~0.12	0.05~0.14	0.06~0.18	0.10~0.22	0.10~0.26	
			PD	PC5300	PC6510	130 (100~160)	0.04~0.07	0.04~0.08	0.04~0.10	0.05~0.12	0.05~0.12	
S	Heat resisting alloy	130~400	PD	PC5300	PC5300	50 (30~100)	0.04~0.10	0.04~0.10	0.04~0.10	0.04~0.10	0.04~0.10	
				PC9540	PC9540	40 (20~80)	0.04~0.10	0.04~0.10	0.04~0.10	0.04~0.10	0.04~0.10	
	Ti-heat resisting alloy	130~400	LD	PC5335	PC5335	60 (40~80)	0.04~0.08	0.04~0.10	0.06~0.12	0.06~0.14	0.06~0.16	
			PD	PC5300	PC5300	60 (40~80)	0.04~0.08	0.04~0.10	0.06~0.12	0.06~0.14	0.06~0.16	
High hardened steel	over 400	PD	PC5300	PC5300	40 (20~80)	0.04~0.05	0.04~0.06	0.04~0.08	0.04~0.08	0.04~0.08		
N	Non-ferrous metal	Aluminium	30~150	ND	H01	H01	300 (250~400)	0.05~0.14	0.06~0.16	0.10~0.20	0.10~0.22	0.12~0.25
		Alloyed copper	150~160	ND	H01	H01	250 (200~300)	0.05~0.14	0.06~0.16	0.10~0.20	0.10~0.22	0.12~0.25



- The Max. feed of 5D holders is 70%~80% of the max. conditions of 2D/3D/4D holders
- In interrupted machining part, reduce 30~50% of feed from the above machining around interrupted part



KED Plus Drill (2D)

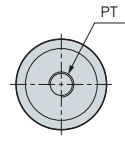
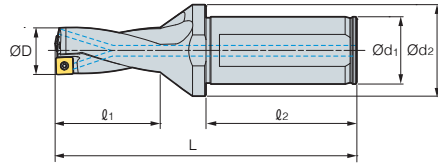
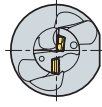


(mm)

Designation	ØD	Ød ₁	Ød ₂	l ₁	l ₂	L	PT	Insert	Screw	Wrench
										
E2D- 12020-04-P	12.0	20	25	27	50	91	1/8	SP□T040204-□□ XO□T040204-□□	FTNA0204	TW06P
12520-04-P	12.5	20	25	27	50	91				
13020-04-P	13.0	20	25	29	50	93				
13520-04-P	13.5	20	25	29	50	93				
14020-05-P	14.0	20	25	31	50	96				
14520-05-P	14.5	20	25	31	50	96				
15020-05-P	15.0	20	25	33	50	99				
15520-05-P	15.5	20	25	33	50	99				
16020-05-P	16.0	20	25	35	50	101				
16525-06-P	16.5	25	34	35	56	107				
17025-06-P	17.0	25	34	37	56	109				
17525-06-P	17.5	25	34	37	56	109				
18025-06-P	18.0	25	34	39	56	112				
18525-06-P	18.5	25	34	39	56	112				
19025-06-P	19.0	25	34	41	56	114				
19525-06-P	19.5	25	34	41	56	114				
20025-07-P	20.0	25	34	43	56	118				
20525-07-P	20.5	25	34	43	56	118				
21025-07-P	21.0	25	34	45	56	120				
21525-07-P	21.5	25	34	45	56	120				
22025-07-P	22.0	25	34	47	56	122				
22525-07-P	22.5	25	34	47	56	122				
23025-07-P	23.0	25	34	49	56	126				
23525-07-P	23.5	25	34	49	56	126				
24032-09-P	24.0	32	44	51	60	133				
24532-09-P	24.5	32	44	51	60	133				
25032-09-P	25.0	32	44	53	60	135				
25532-09-P	25.5	32	44	53	60	135				
26032-09-P	26.0	32	44	55	60	137				
26532-09-P	26.5	32	44	55	60	137				
27032-09-P	27.0	32	44	57	60	140				
27532-09-P	27.5	32	44	57	60	140				
28032-09-P	28.0	32	44	59	60	143				
28532-09-P	28.5	32	44	59	60	143				
29032-09-P	29.0	32	44	61	60	145				
29532-09-P	29.5	32	44	61	60	145				
30032-11-P	30.0	32	44	63	60	150				
30532-11-P	30.5	32	44	63	60	150				
31032-11-P	31.0	32	44	65	60	152				
31532-11-P	31.5	32	44	65	60	152				
32032-11-P	32.0	32	44	67	60	154				
32532-11-P	32.5	32	44	67	60	154				
33032-11-P	33.0	32	44	69	60	157				
33532-11-P	33.5	32	44	69	60	157				
34032-11-P	34.0	32	44	71	60	159				
34532-11-P	34.5	32	44	71	60	159				
35032-11-P	35.0	32	44	73	60	161				
35532-11-P	35.5	32	44	73	60	161				
							1/4	SP□T090308-□□ XO□T090305-□□	FTKA0307	TW09S
								SP□T11T308-□□ XO□T11T306-□□	FTKA03508	TW15S

↻ Applicable inserts F03-04

KED Plus Drill (2D)



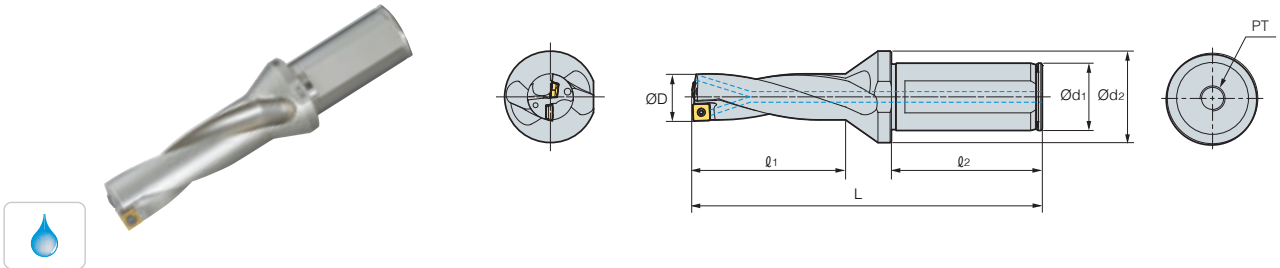
(mm)

Designation	ØD	Ød ₁	Ød ₂	l ₁	l ₂	L	PT	Insert	Screw	Wrench
E2D-										
36040-13-P	36.0	40	48	76	70	176	1/4	SP□T130410-□□ XO□T130406-□□	FTKA0410	TW15S
36540-13-P	36.5	40	48	76	70	176				
37040-13-P	37.0	40	48	78	70	178				
37540-13-P	37.5	40	48	78	70	178				
38040-13-P	38.0	40	48	80	70	181				
38540-13-P	38.5	40	48	80	70	181				
39040-13-P	39.0	40	48	82	70	183				
39540-13-P	39.5	40	48	82	70	183				
40040-13-P	40.0	40	48	84	70	186				
40540-13-P	40.5	40	48	84	70	186				
41040-13-P	41.0	40	48	86	70	188				
41540-13-P	41.5	40	48	86	70	188				
42040-13-P	42.0	40	48	88	70	191				
42540-13-P	42.5	40	48	88	70	191				
43040-15-P	43.0	40	58	91	70	196				
43540-15-P	43.5	40	58	91	70	196				
44040-15-P	44.0	40	58	93	70	198				
44540-15-P	44.5	40	58	93	70	198				
45040-15-P	45.0	40	58	95	70	201				
45540-15-P	45.5	40	58	95	70	201				
46040-15-P	46.0	40	58	97	70	203				
46540-15-P	46.5	40	58	97	70	203				
47040-15-P	47.0	40	58	99	70	206				
47540-15-P	47.5	40	58	99	70	206				
48040-15-P	48.0	40	58	101	70	208				
48540-15-P	48.5	40	58	101	70	208				
49040-15-P	49.0	40	58	103	70	210				
49540-15-P	49.5	40	58	103	70	210				
50040-15-P	50.0	40	58	105	70	212				
50540-15-P	50.5	40	58	105	70	212				
51040-18-P	51.0	40	68	108	70	218				
51540-18-P	51.5	40	68	108	70	218				
52040-18-P	52.0	40	68	110	70	220				
52540-18-P	52.5	40	68	110	70	220				
53040-18-P	53.0	40	68	112	70	222				
53540-18-P	53.5	40	68	112	70	222				
54040-18-P	54.0	40	68	114	70	224				
54540-18-P	54.5	40	68	114	70	224				
55040-18-P	55.0	40	68	116	70	226				
55540-18-P	55.5	40	68	116	70	226				
56040-18-P	56.0	40	68	118	70	230				
56540-18-P	56.5	40	68	118	70	230				
57040-18-P	57.0	40	68	121	70	233				
57540-18-P	57.5	40	68	121	70	233				
58040-18-P	58.0	40	68	124	70	236				
58540-18-P	58.5	40	68	124	70	236				
59040-18-P	59.0	40	68	127	70	239				
59540-18-P	59.5	40	68	127	70	239				
60040-18-P	60.0	40	68	130	70	242				
60540-18-P	60.5	40	68	130	70	242				
								SP□T180510-□□ XO□T180508-□□	FTNA0511	TW20-100

↻ Applicable inserts F03-04



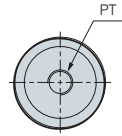
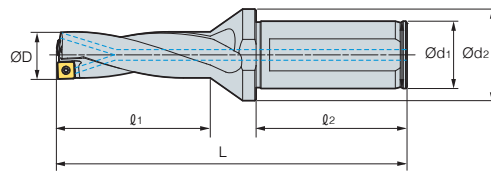
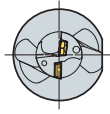
KED Plus Drill (3D)



Designation		ØD	Ød ₁	Ød ₂	l ₁	l ₂	L	PT	Insert	Screw	Wrench
E3D-	12020-04-P	12.0	20	25	39	50	103	1/8	SP□T040204-□□ XO□T040204-□□	FTNA0204	TW06P
	12520-04-P	12.5	20	25	39	50	103				
	13020-04-P	13.0	20	25	42	50	106				
	13520-04-P	13.5	20	25	42	50	106				
	14020-05-P	14.0	20	25	45	50	110				
	14520-05-P	14.5	20	25	45	50	110		SP□T050204-□□ XO□T050204-□□	FTNA0204	TW06P
	15020-05-P	15.0	20	25	48	50	114				
	15520-05-P	15.5	20	25	48	50	114				
	16020-05-P	16.0	20	25	51	50	117				
	16525-06-P	16.5	25	34	51	56	123				
	17025-06-P	17.0	25	34	54	56	126		SP□T060205-□□ XO□T060204-□□	FTKA02206S	TW07P
	17525-06-P	17.5	25	34	54	56	126				
	18025-06-P	18.0	25	34	57	56	130				
	18525-06-P	18.5	25	34	57	56	130				
	19025-06-P	19.0	25	34	60	56	133				
	19525-06-P	19.5	25	34	60	56	133		SP□T07T208-□□ XO□T07T205-□□	FTKA02565	TW07S
	20025-07-P	20.0	25	34	63	56	138				
	20525-07-P	20.5	25	34	63	56	138				
	21025-07-P	21.0	25	34	66	56	141				
	21525-07-P	21.5	25	34	66	56	141				
	22025-07-P	22.0	25	34	69	56	144		SP□T090308-□□ XO□T090305-□□	FTKA0307	TW09S
	22525-07-P	22.5	25	34	69	56	144				
	23025-07-P	23.0	25	34	72	56	149				
	23525-07-P	23.5	25	34	72	56	149				
	24032-09-P	24.0	32	44	75	60	157				
	24532-09-P	24.5	32	44	75	60	157				
	25032-09-P	25.0	32	44	78	60	160				
	25532-09-P	25.5	32	44	78	60	160				
	26032-09-P	26.0	32	44	81	60	163				
	26532-09-P	26.5	32	44	81	60	163				
	27032-09-P	27.0	32	44	84	60	167				
	27532-09-P	27.5	32	44	84	60	167				
	28032-09-P	28.0	32	44	87	60	171				
	28532-09-P	28.5	32	44	87	60	171				
	29032-09-P	29.0	32	44	90	60	174				
29532-09-P	29.5	32	44	90	60	174	SP□T11T308-□□ XO□T11T306-□□	FTKA03508	TW15S		
30032-11-P	30.0	32	44	93	60	180					
30532-11-P	30.5	32	44	93	60	180					
31032-11-P	31.0	32	44	96	60	183					
31532-11-P	31.5	32	44	96	60	183					
32032-11-P	32.0	32	44	99	60	186					
32532-11-P	32.5	32	44	99	60	186					
33032-11-P	33.0	32	44	102	60	190					
33532-11-P	33.5	32	44	102	60	190					
34032-11-P	34.0	32	44	105	60	193					
34532-11-P	34.5	32	44	105	60	193					
35032-11-P	35.0	32	44	108	60	196					
35532-11-P	35.5	32	44	108	60	196					

↻ Applicable inserts F03-04

KED Plus Drill (3D)



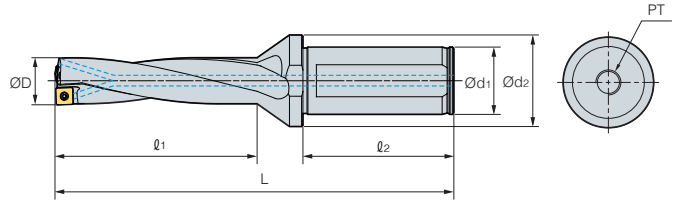
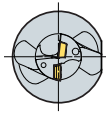
(mm)

Designation	ØD	Ød ₁	Ød ₂	l ₁	l ₂	L	PT	Insert	Screw	Wrench
E3D-										
36040-13-P	36.0	40	48	112	70	212	1/4	SP□T130410-□□ XO□T130406-□□	FTKA0410	TW15S
36540-13-P	36.5	40	48	112	70	212				
37040-13-P	37.0	40	48	115	70	215				
37540-13-P	37.5	40	48	115	70	215				
38040-13-P	38.0	40	48	118	70	219				
38540-13-P	38.5	40	48	118	70	219				
39040-13-P	39.0	40	48	121	70	222				
39540-13-P	39.5	40	48	121	70	222				
40040-13-P	40.0	40	48	124	70	226				
40540-13-P	40.5	40	48	124	70	226				
41040-13-P	41.0	40	48	127	70	229				
41540-13-P	41.5	40	48	127	70	229				
42040-13-P	42.0	40	48	130	70	233				
42540-13-P	42.5	40	48	130	70	233				
43040-15-P	43.0	40	58	134	70	239				
43540-15-P	43.5	40	58	134	70	239				
44040-15-P	44.0	40	58	137	70	242				
44540-15-P	44.5	40	58	137	70	242				
45040-15-P	45.0	40	58	140	70	246				
45540-15-P	45.5	40	58	140	70	246				
46040-15-P	46.0	40	58	143	70	249				
46540-15-P	46.5	40	58	143	70	249				
47040-15-P	47.0	40	58	146	70	253				
47540-15-P	47.5	40	58	146	70	253				
48040-15-P	48.0	40	58	149	70	256				
48540-15-P	48.5	40	58	149	70	256				
49040-15-P	49.0	40	58	152	70	259				
49540-15-P	49.5	40	58	152	70	259				
50040-15-P	50.0	40	58	155	70	262				
50540-15-P	50.5	40	58	155	70	262				
51040-18-P	51.0	40	68	159	70	269				
51540-18-P	51.5	40	68	159	70	269				
52040-18-P	52.0	40	68	162	70	272				
52540-18-P	52.5	40	68	162	70	272				
53040-18-P	53.0	40	68	165	70	275				
53540-18-P	53.5	40	68	165	70	275				
54040-18-P	54.0	40	68	168	70	278				
54540-18-P	54.5	40	68	168	70	278				
55040-18-P	55.0	40	68	171	70	281				
55540-18-P	55.5	40	68	171	70	281				
56040-18-P	56.0	40	68	174	70	286				
56540-18-P	56.5	40	68	174	70	286				
57040-18-P	57.0	40	68	178	70	290				
57540-18-P	57.5	40	68	178	70	290				
58040-18-P	58.0	40	68	182	70	294				
58540-18-P	58.5	40	68	182	70	294				
59040-18-P	59.0	40	68	186	70	298				
59540-18-P	59.5	40	68	186	70	298				
60040-18-P	60.0	40	68	190	70	302				
60540-18-P	60.5	40	68	190	70	302				
								SP□T180510-□□ XO□T180508-□□	FTNA0511	TW20-100

↻ Applicable inserts F03-04



KED Plus Drill (4D)

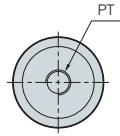
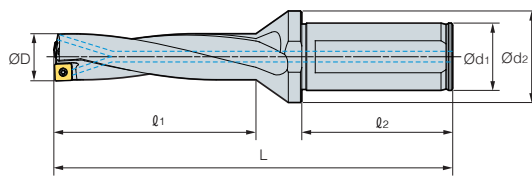
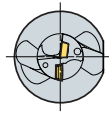


(mm)

Designation	ØD	Ød ₁	Ød ₂	l ₁	l ₂	L	PT	Insert	Screw	Wrench
E4D- 12020-04-P	12.0	20	25	51	50	115	1/8	SP□T040204-□□ XO□T040204-□□	FTNA0204	TW06P
12520-04-P	12.5	20	25	51	50	115				
13020-04-P	13.0	20	25	55	50	119				
13520-04-P	13.5	20	25	55	50	119				
14020-05-P	14.0	20	25	59	50	124				
14520-05-P	14.5	20	25	59	50	124				
15020-05-P	15.0	20	25	63	50	129				
15520-05-P	15.5	20	25	63	50	129				
16020-05-P	16.0	20	25	67	50	133				
16525-06-P	16.5	25	34	67	56	139				
17025-06-P	17.0	25	34	71	56	143				
17525-06-P	17.5	25	34	71	56	143				
18025-06-P	18.0	25	34	75	56	148				
18525-06-P	18.5	25	34	75	56	148				
19025-06-P	19.0	25	34	79	56	152				
19525-06-P	19.5	25	34	79	56	152				
20025-07-P	20.0	25	34	83	56	158				
20525-07-P	20.5	25	34	83	56	158				
21025-07-P	21.0	25	34	87	56	162				
21525-07-P	21.5	25	34	87	56	162				
22025-07-P	22.0	25	34	91	56	166				
22525-07-P	22.5	25	34	91	56	166				
23025-07-P	23.0	25	34	95	56	172				
23525-07-P	23.5	25	34	95	56	172				
24032-09-P	24.0	32	44	99	60	181	1/4	SP□T090308-□□ XO□T090305-□□	FTKA0307	TW09S
24532-09-P	24.5	32	44	99	60	181				
25032-09-P	25.0	32	44	103	60	185				
25532-09-P	25.5	32	44	103	60	185				
26032-09-P	26.0	32	44	107	60	189				
26532-09-P	26.5	32	44	107	60	189				
27032-09-P	27.0	32	44	111	60	194				
27532-09-P	27.5	32	44	111	60	194				
28032-09-P	28.0	32	44	115	60	199				
28532-09-P	28.5	32	44	115	60	199				
29032-09-P	29.0	32	44	119	60	203				
29532-09-P	29.5	32	44	119	60	203				
30032-11-P	30.0	32	44	123	60	210				
30532-11-P	30.5	32	44	123	60	210				
31032-11-P	31.0	32	44	127	60	214				
31532-11-P	31.5	32	44	127	60	214				
32032-11-P	32.0	32	44	131	60	218				
32532-11-P	32.5	32	44	131	60	218				
33032-11-P	33.0	32	44	135	60	223				
33532-11-P	33.5	32	44	135	60	223				
34032-11-P	34.0	32	44	139	60	227				
34532-11-P	34.5	32	44	139	60	227				
35032-11-P	35.0	32	44	143	60	231				
35532-11-P	35.5	32	44	143	60	231				

↻ Applicable inserts F03-04

KED Plus Drill (4D)



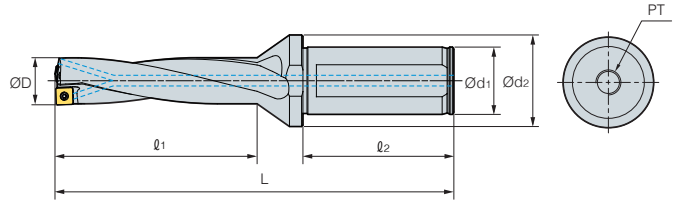
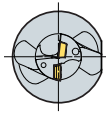
(mm)

Designation	ØD	Ød ₁	Ød ₂	l ₁	l ₂	L	PT	Insert	Screw	Wrench
E4D-										
36040-13-P	36.0	40	48	148	70	248	1/4	SP□T130410-□□ XO□T130406-□□	FTKA0410	TW15S
36540-13-P	36.5	40	48	148	70	248				
37040-13-P	37.0	40	48	152	70	252				
37540-13-P	37.5	40	48	152	70	252				
38040-13-P	38.0	40	48	156	70	257				
38540-13-P	38.5	40	48	156	70	257				
39040-13-P	39.0	40	48	160	70	261				
39540-13-P	39.5	40	48	160	70	261				
40040-13-P	40.0	40	48	164	70	266				
40540-13-P	40.5	40	48	164	70	266				
41040-13-P	41.0	40	48	168	70	270				
41540-13-P	41.5	40	48	168	70	270				
42040-13-P	42.0	40	48	172	70	275				
42540-13-P	42.5	40	48	172	70	275				
43040-15-P	43.0	40	58	177	70	282				
43540-15-P	43.5	40	58	177	70	282				
44040-15-P	44.0	40	58	181	70	286				
44540-15-P	44.5	40	58	181	70	286				
45040-15-P	45.0	40	58	185	70	291				
45540-15-P	45.5	40	58	185	70	291				
46040-15-P	46.0	40	58	189	70	295				
46540-15-P	46.5	40	58	189	70	295				
47040-15-P	47.0	40	58	193	70	300				
47540-15-P	47.5	40	58	193	70	300				
48040-15-P	48.0	40	58	197	70	304				
48540-15-P	48.5	40	58	197	70	304				
49040-15-P	49.0	40	58	201	70	308				
49540-15-P	49.5	40	58	201	70	308				
50040-15-P	50.0	40	58	205	70	312				
50540-15-P	50.5	40	58	205	70	312				
51040-18-P	51.0	40	68	210	70	320				
51540-18-P	51.5	40	68	210	70	320				
52040-18-P	52.0	40	68	214	70	324				
52540-18-P	52.5	40	68	214	70	324				
53040-18-P	53.0	40	68	218	70	328				
53540-18-P	53.5	40	68	218	70	328				
54040-18-P	54.0	40	68	222	70	332				
54540-18-P	54.5	40	68	222	70	332				
55040-18-P	55.0	40	68	226	70	336				
55540-18-P	55.5	40	68	226	70	336				
56040-18-P	56.0	40	68	230	70	342				
56540-18-P	56.5	40	68	230	70	342				
57040-18-P	57.0	40	68	235	70	347				
57540-18-P	57.5	40	68	235	70	347				
58040-18-P	58.0	40	68	240	70	352				
58540-18-P	58.5	40	68	240	70	352				
59040-18-P	59.0	40	68	245	70	357				
59540-18-P	59.5	40	68	245	70	357				
60040-18-P	60.0	40	68	250	70	362				
60540-18-P	60.5	40	68	250	70	362				
								SP□T180510-□□ XO□T180508-□□	FTNA0511	TW20-100

↻ Applicable inserts F03-04



KED Plus Drill (5D)

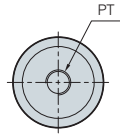
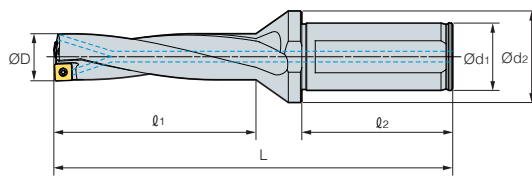
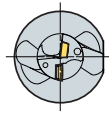


(mm)

Designation	ØD	Ød ₁	Ød ₂	l ₁	l ₂	L	PT	Insert	Screw	Wrench
E5D- 12020-04-P	12.0	20	25	63	50	127	1/8	SP□T040204-□□ XO□T040204-□□	FTNA0204	TW06P
12520-04-P	12.5	20	25	63	50	127				
13020-04-P	13.0	20	25	68	50	132				
13520-04-P	13.5	20	25	68	50	132				
14020-05-P	14.0	20	25	73	50	138				
14520-05-P	14.5	20	25	73	50	138		SP□T050204-□□ XO□T050204-□□	FTNA0204	TW06P
15020-05-P	15.0	20	25	78	50	144				
15520-05-P	15.5	20	25	78	50	144				
16020-05-P	16.0	20	25	83	50	149				
16525-06-P	16.5	25	34	83	56	155				
17025-06-P	17.0	25	34	88	56	160		SP□T060205-□□ XO□T060204-□□	FTKA02206S	TW07P
17525-06-P	17.5	25	34	88	56	160				
18025-06-P	18.0	25	34	93	56	166				
18525-06-P	18.5	25	34	93	56	166				
19025-06-P	19.0	25	34	98	56	171				
19525-06-P	19.5	25	34	98	56	171		SP□T07T208-□□ XO□T07T205-□□	FTKA02565	TW07S
20025-07-P	20.0	25	34	103	56	178				
20525-07-P	20.5	25	34	103	56	178				
21025-07-P	21.0	25	34	108	56	183				
21525-07-P	21.5	25	34	108	56	183				
22025-07-P	22.0	25	34	113	56	188	1/4	SP□T090308-□□ XO□T090305-□□	FTKA0307	TW09S
22525-07-P	22.5	25	34	113	56	188				
23025-07-P	23.0	25	34	118	56	195				
23525-07-P	23.5	25	34	118	56	195				
24032-09-P	24.0	32	44	123	60	205				
24532-09-P	24.5	32	44	123	60	205				
25032-09-P	25.0	32	44	128	60	210				
25532-09-P	25.5	32	44	128	60	210				
26032-09-P	26.0	32	44	133	60	215				
26532-09-P	26.5	32	44	133	60	215				
27032-09-P	27.0	32	44	138	60	221				
27532-09-P	27.5	32	44	138	60	221				
28032-09-P	28.0	32	44	143	60	227				
28532-09-P	28.5	32	44	143	60	227				
29032-09-P	29.0	32	44	148	60	232				
29532-09-P	29.5	32	44	148	60	232				
30032-11-P	30.0	32	44	153	60	240				
30532-11-P	30.5	32	44	153	60	240				
31032-11-P	31.0	32	44	158	60	245				
31532-11-P	31.5	32	44	158	60	245				
32032-11-P	32.0	32	44	163	60	250				
32532-11-P	32.5	32	44	163	60	250				
33032-11-P	33.0	32	44	168	60	256				
33532-11-P	33.5	32	44	168	60	256				
34032-11-P	34.0	32	44	173	60	261				
34532-11-P	34.5	32	44	173	60	261				
35032-11-P	35.0	32	44	178	60	266				
35532-11-P	35.5	32	44	178	60	266				
								SP□T11T308-□□ XO□T11T306-□□	FTKA03508	TW15S

↻ Applicable inserts F03-04

KED Plus Drill (5D)



(mm)

Designation	ØD	Ød ₁	Ød ₂	l ₁	l ₂	L	PT	Insert	Screw	Wrench
E5D-										
36040-13-P	36.0	40	48	184	70	284				
36540-13-P	36.5	40	48	184	70	284				
37040-13-P	37.0	40	48	189	70	289				
37540-13-P	37.5	40	48	189	70	289				
38040-13-P	38.0	40	48	194	70	295				
38540-13-P	38.5	40	48	194	70	295				
39040-13-P	39.0	40	48	199	70	300				
39540-13-P	39.5	40	48	199	70	300				
40040-13-P	40.0	40	48	204	70	306				
40540-13-P	40.5	40	48	204	70	306				
41040-13-P	41.0	40	48	209	70	311				
41540-13-P	41.5	40	48	209	70	311				
42040-13-P	42.0	40	48	214	70	317				
42540-13-P	42.5	40	48	214	70	317				
43040-15-P	43.0	40	58	220	70	325				
43540-15-P	43.5	40	58	221	70	326				
44040-15-P	44.0	40	58	225	70	330				
44540-15-P	44.5	40	58	225	70	330				
45040-15-P	45.0	40	58	230	70	336				
45540-15-P	45.5	40	58	230	70	336				
46040-15-P	46.0	40	58	235	70	341				
46540-15-P	46.5	40	58	235	70	341				
47040-15-P	47.0	40	58	240	70	347				
47540-15-P	47.5	40	58	240	70	347				
48040-15-P	48.0	40	58	245	70	352				
48540-15-P	48.5	40	58	245	70	352				
49040-15-P	49.0	40	58	250	70	357				
49540-15-P	49.5	40	58	250	70	357				
50040-15-P	50.0	40	58	255	70	362				
50540-15-P	50.5	40	58	255	70	362				
51040-18-P	51.0	40	68	261	70	371				
51540-18-P	51.5	40	68	261	70	371				
52040-18-P	52.0	40	68	266	70	376				
52540-18-P	52.5	40	68	266	70	376				
53040-18-P	53.0	40	68	271	70	381				
53540-18-P	53.5	40	68	271	70	381				
54040-18-P	54.0	40	68	276	70	386				
54540-18-P	54.5	40	68	276	70	386				
55040-18-P	55.0	40	68	281	70	391				
55540-18-P	55.5	40	68	281	70	391				
56040-18-P	56.0	40	68	286	70	398				
56540-18-P	56.5	40	68	286	70	398				
57040-18-P	57.0	40	68	292	70	404				
57540-18-P	57.5	40	68	292	70	404				
58040-18-P	58.0	40	68	298	70	410				
58540-18-P	58.5	40	68	298	70	410				
59040-18-P	59.0	40	68	304	70	416				
59540-18-P	59.5	40	68	304	70	416				
60040-18-P	60.0	40	68	310	70	422				
60540-18-P	60.5	40	68	310	70	422				
							1/4	SP□T130410-□□ XO□T130406-□□	FTKA0410	TW15S
								SP□T15M510-□□ XO□T15M508-□□	FTNC04511	TW20S
								SP□T180510-□□ XO□T180508-□□	FTNA0511	TW20-100

↻ Applicable inserts F03-04



F

Drills

High quality and high feed top solid indexable drill


TPDC Plus Drill **new**

(TPDC-XP, CP, CM, CN, CP-FC)

- The optimal tool shape for drilling realizing high precision and high feed machining as of carbide solid drill performance level
- Usable for various machining through enlarged line-up by workpieces, depth of cuts and workpiece shapes

Code system

• Insert

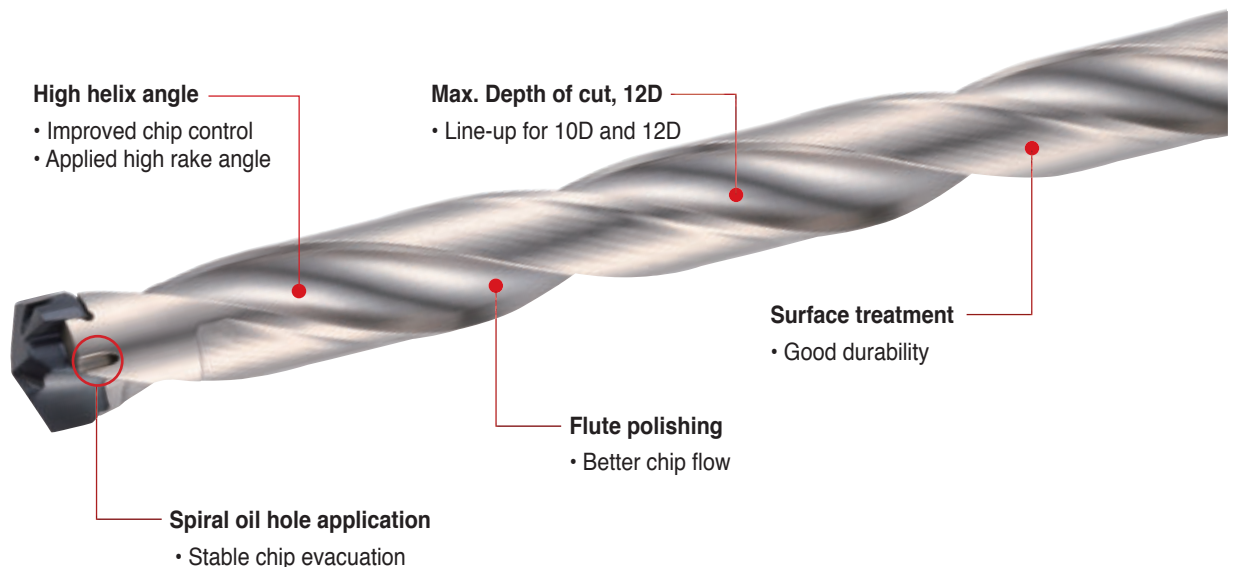
TPD	1500	C	P	-	
Top solid Piercing Drill	Drill dia. 1500: Ø15.00 mm	Insert type X, C: Cone type	Machining area P: Steel and general M: Stainless steel K: Cast iron N: Non-ferrous metal		Cutting edge No code: Standard F: Flat FC: Flat Candle

• Holder

TPD	C	5D	-	150	20	-	75
Top solid Piercing Drill	Insert type X, C: Cone type	Aspect ratio (L/D) 1.5D, 3D, 5D 8D, 10D, 12D		Drill dia. 150: Ø15.00-Ø15.99 mm	Shank dia. 20: Ø20 mm		Flute length 75: 75 mm

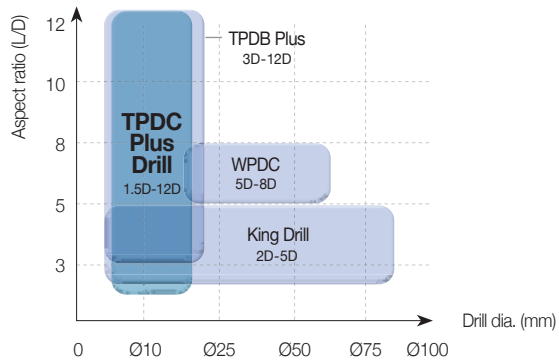
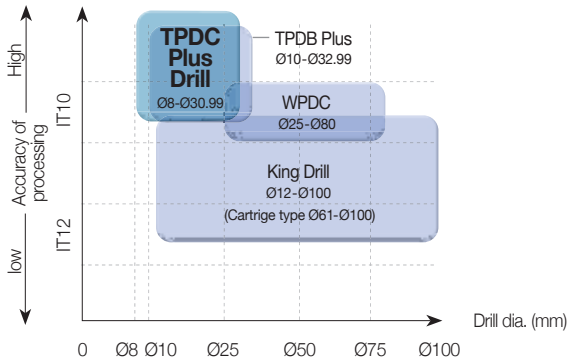
Features

- One step clamp system - Increased stability and shortened setting time
- High helix angle and flute polishing - Reduced cutting load and enhanced chip evacuation
- Various applications from enlarged line-up by depth of cuts and shapes of workpiece



F Technical Information for TPDC Plus Drill

Application range



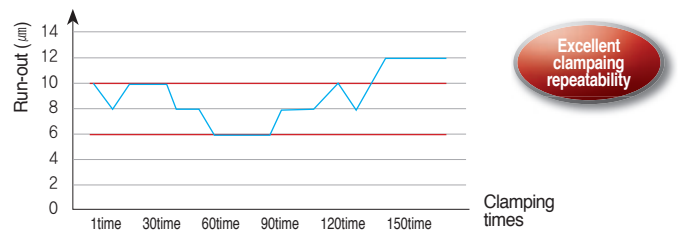
Run-out

Durability evaluation

- Workpiece** Alloy steel (SCM440, HRC22)
- Cutting conditions** vc (m/min) = 90, fn (mm/rev) = 0.25, ap (mm) = 60, wet (10bar)
- Tools** **Insert** TPD1500CP(PC5335)
Holder TPDC5D-15020-75 (Drill dia. = Ø15 mm)

Long tool life with the setting run-out, lower than 15 μm after using 40 inserts

Clamping repeatability evaluation

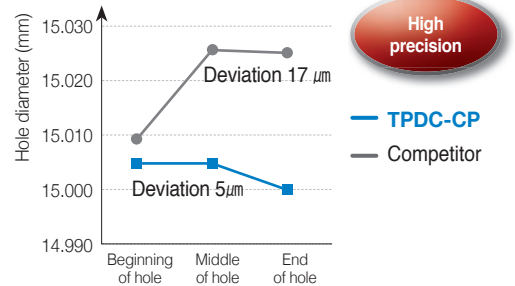
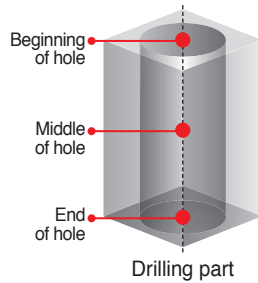


Excellent clamping system keeping the run-out, lower than 6 μm after clamping 150 times repeatedly

Performance evaluation

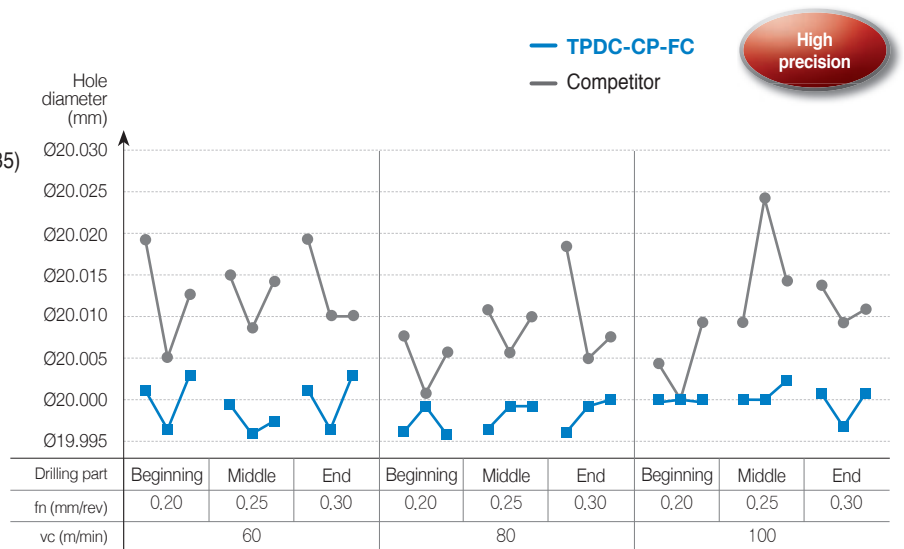
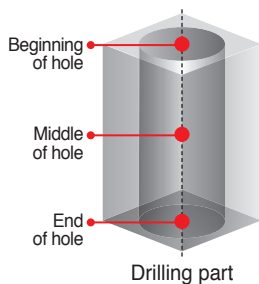
Precision

- Workpiece** Carbon steel (SM45C, HRC19)
- Cutting conditions** vc (m/min) = 60, fn (mm/rev) = 0.2, ap (mm) = 150, wet (20bar)
- Tools** **Insert** TPD1500CP (PC5335)
Holder TPDC12D-15020-170 (Drill dia. = Ø15 mm)



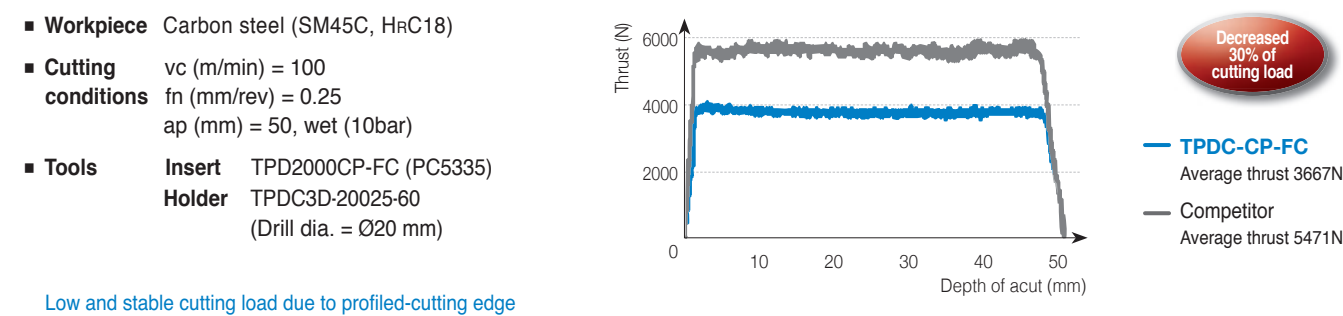
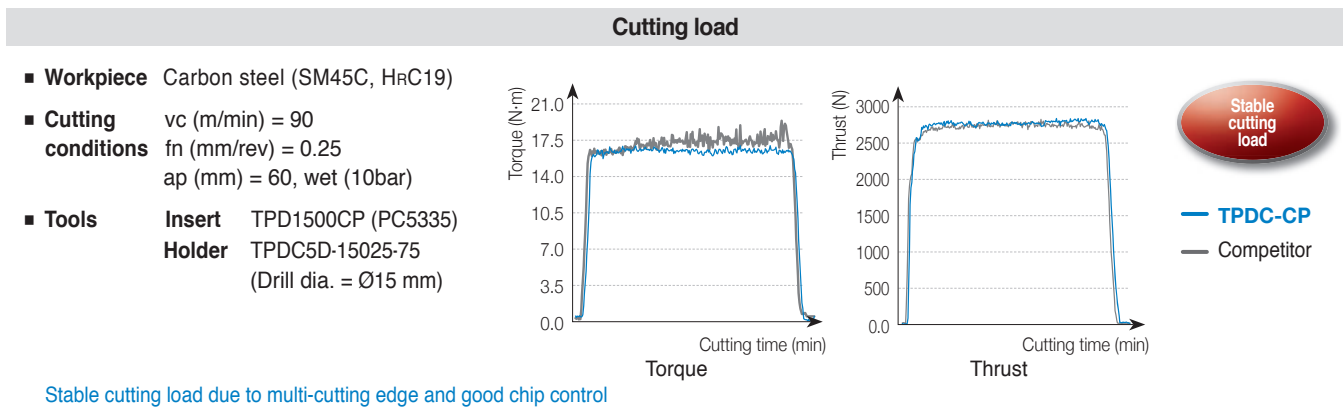
High precision in deep hole-making

- Workpiece** Carbon steel (SM45C, HRC18)
- Cutting conditions** vc (m/min) = 60~100, fn (mm/rev) = 0.2~0.3, ap (mm) = 50, wet (20 bar)
- Tools** **Insert** TPD2000CP-FC (PC5335)
Holder TPDC3D-20025-60 (Drill dia. = Ø20 mm)

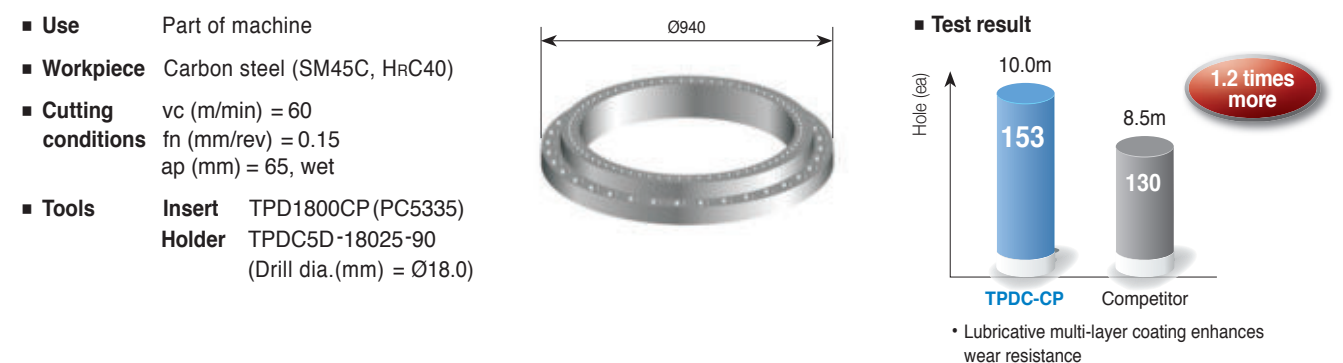
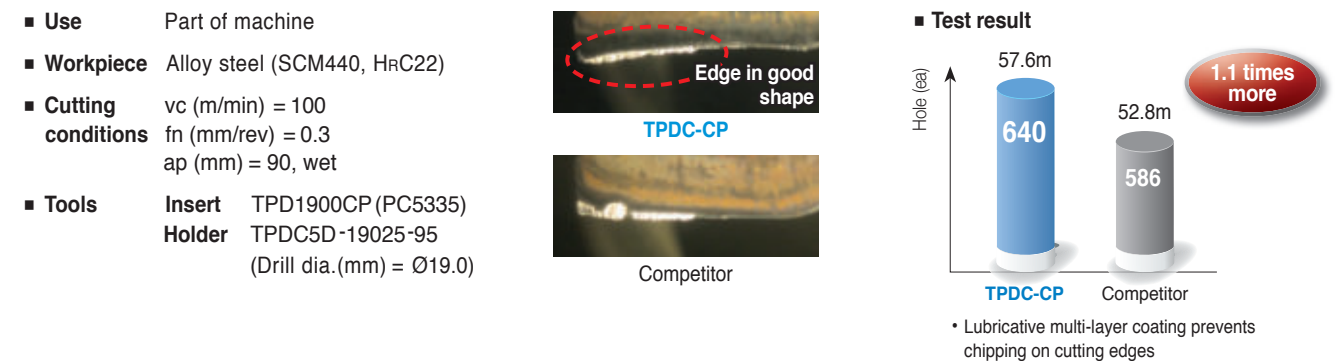


High precision and excellent centering due to profiled cutting edge

Performance evaluation



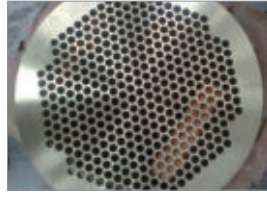
Application examples



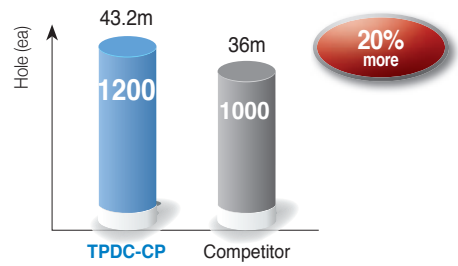
F Technical Information for TPDC Plus Drill

Application examples

- **Use** Tube sheet
- **Workpiece** Carbon steel (S235JR, HRC18)
- **Cutting conditions**
 - vc (m/min) = 85
 - n (rpm) = 1381
 - fn (mm/rev) = 0.27
 - ap (mm) = 12mm x 3Passes, wet
- **Tools**
 - Insert** TPD1960CP (PC330P)
 - Holder** TPDC3D-19025-57



Test result

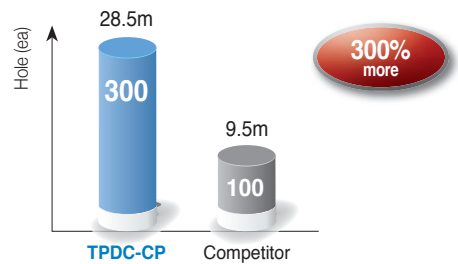


- Optimized cutting edge enhances wear resistance due to stable cutting load and lubricated multi-layer coating

- **Use** Turret flange
- **Workpiece** Alloy steel (SCM440, HRC22)
- **Cutting conditions**
 - vc (m/min) = 82
 - n (rpm) = 2000
 - fn (mm/rev) = 0.2
 - ap (mm) = 95, wet
- **Tools**
 - Insert** TPD1300CP (PC5335)
 - Holder** TPDC8D-13016-104








Test result



- Lubricated multi-layer coating improving chipping resistance prevents chipping on the cutting edge

Insert features

Shape	Application	Drill dia. (mm)	Features
 XP <small>new</small>	P	Ø8.00~Ø11.99	<ul style="list-style-type: none"> • High durability due to the strong clamping system • Excellent quality of machining and stable machining from high clamping force • Enhanced performance by high lubricated grade
 CP	P K	Ø12.00~Ø30.99	<ul style="list-style-type: none"> • High quality machining due to excellent centering: Good roundness and surface finish • Excellent chip control from exclusive edge design: Stable machining by good chip forming and chip evacuation
 CM <small>new</small>	M	Ø12.00~Ø30.99	<ul style="list-style-type: none"> • Ensuring strength of point and cutting edge: Stable machinability • Increased stability of machining due to low cutting load • Applied grade with high built up edge resistance and chipping resistance
 CN <small>new</small>	N	Ø12.00~Ø30.99	<ul style="list-style-type: none"> • Cutting edge with low cutting load: Excellent chip evacuation from increased surface finish of insert by special after treatment • Long tool life due to ultra-fine substrate application
 CP-FC <small>new</small>	P	Ø12.00~Ø30.99	<ul style="list-style-type: none"> • Cutting edge shape with excellent centering: Stable machinability from low cutting load • Available in various machining applications: Flat surface, angled surface, curved surface drilling, plunging and boring • Reduced cycle time by simplified tools: Endmill+drill machining → TPDC-CP-FC insert



How to clamp insert

Using the improved wrench

- Using the insert with slot on the top (Use the improved inserts only)



1 Clean the mounting seat with air or cloth

2 Put an insert on the holder

3 Put the wrench in the slot parallel



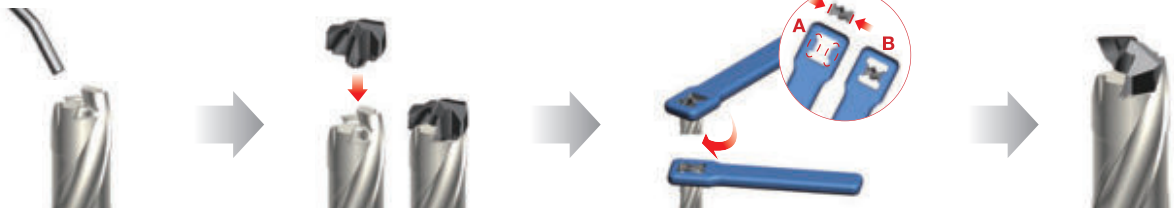
4 After fixing the wrench firmly, turn it clockwise and clamp the insert to the holder

Clamped state

Using the existing wrench

- Using any inserts (Use both existing inserts and improved inserts)

Use only the improved wrench later



1 Clean the mounting seat with air or cloth

2 Put an insert on the holder

3 A part of wrench and B part of insert must be parallel to each other before clamping the insert. Turn the wrench clockwise to finish clamping.

Clamped state

F Technical Information for TPDC Plus Drill

Recommended cutting conditions (TPDC-XP)

• 3D Drilling

Workpiece			Grade	vc (m/min)	Aspect ratio (L/D) = 3D		
ISO	Workpiece	HB			Feed rate (mm/rev) per drill dia. (mm)		
					Ø8.00~Ø9.99	Ø10.00~Ø11.99	
P	Carbon steel	Low carbon steel	80~120	PC325U	110 (80~140)	0.12~0.22	0.15~0.28
		High carbon steel	180~280	PC325U	90 (70~110)		
P	Alloy steel	Low alloy steel	140~260	PC325U	90 (70~110)	0.12~0.20	0.14~0.25
		Low alloy heat-treated steel	200~400	PC325U	70 (50~90)		
		High alloy steel	260~320	PC325U	70 (50~90)	0.10~0.15	0.12~0.18
		High alloy heat-treated steel	300~450	PC325U	60 (40~80)		
K	Cast iron	Gray cast iron	150~230	PC325U	125 (90~160)	0.15~0.30	0.20~0.35
		Ductile cast iron	160~260	PC325U	110 (80~140)		

※ In interrupted machining, reduce the feed to 0.1-0.15 machining around the interrupted part

• 5D Drilling

Workpiece			Grade	vc (m/min)	Aspect ratio (L/D) = 5D		
ISO	Workpiece	HB			Feed rate (mm/rev) per drill dia. (mm)		
					Ø8.00~Ø9.99	Ø10.00~Ø11.99	
P	Carbon steel	Low carbon steel	80~120	PC325U	110 (80~140)	0.12~0.22	0.15~0.28
		High carbon steel	180~280	PC325U	90 (70~110)		
P	Alloy steel	Low alloy steel	140~260	PC325U	90 (70~110)	0.12~0.20	0.14~0.25
		Low alloy heat-treated steel	200~400	PC325U	70 (50~90)		
		High alloy steel	260~320	PC325U	70 (50~90)	0.10~0.15	0.12~0.18
		High alloy heat-treated steel	300~450	PC325U	60 (40~80)		
K	Cast iron	Gray cast iron	150~230	PC325U	125 (90~160)	0.15~0.30	0.20~0.35
		Ductile cast iron	160~260	PC325U	110 (80~140)		

※ In interrupted machining, reduce the feed to 0.1-0.15 machining around the interrupted part

• 8D Drilling

Workpiece			Grade	vc (m/min)	Aspect ratio (L/D) = 8D		
ISO	Workpiece	HB			Feed rate (mm/rev) per drill dia. (mm)		
					Ø8.00~Ø9.99	Ø10.00~Ø11.99	
P	Carbon steel	Low carbon steel	80~120	PC325U	100 (70~130)	0.10~0.20	0.12~0.25
		High carbon steel	180~280	PC325U	80 (60~100)		
P	Alloy steel	Low alloy steel	140~260	PC325U	80 (60~100)	0.10~0.18	0.12~0.20
		Low alloy heat-treated steel	200~400	PC325U	60 (40~80)		
		High alloy steel	260~320	PC325U	60 (40~80)	0.09~0.13	0.10~0.16
		High alloy heat-treated steel	300~450	PC325U	50 (30~70)		
K	Cast iron	Gray cast iron	150~230	PC325U	115 (80~150)	0.12~0.27	0.17~0.32
		Ductile cast iron	160~260	PC325U	100 (70~130)		

※ In interrupted machining, reduce the feed to 0.1-0.15 machining around the interrupted part

※ In case of 8D drilling, please use a Pilot Drill



Recommended cutting conditions (TPDC-CP/CM/CN)

• 1.5D/3D Drilling

Workpiece			Insert	Grade	vc (m/min)	Aspect ratio (L/D) = 1.5D, 3D			
ISO	Workpiece	HB				Feed rate (mm/rev) per drill dia. (mm)			
						Ø12.00~Ø17.99	Ø18.00~Ø25.99	Ø26.00~Ø30.99	
P	Carbon steel	Low carbon steel	80~120	CP	PC5335 PC330P	120 (90~140)	0.25~0.35	0.30~0.40	0.35~0.45
		High carbon steel	180~280	CP	PC5335 PC330P	110 (80~130)	0.25~0.35	0.30~0.40	0.30~0.45
	Alloy steel	Low alloy steel	140~260	CP	PC5335 PC5300	120 (90~140)	0.28~0.40	0.33~0.43	0.38~0.48
		Low alloy heat-treated steel	200~400	CP	PC5335 PC5300	80 (60~100)	0.28~0.40	0.33~0.43	0.30~0.48
		High alloy steel	260~320	CP	PC5335 PC5300	75 (60~90)	0.20~0.35	0.22~0.40	0.25~0.45
		High alloy heat-treated steel	300~450	CP	PC5335 PC5300	65 (50~80)	0.20~0.35	0.22~0.40	0.22~0.45
M	Stainless steel	Austenitic	135~275	CM	PC330N	65 (50~80)	0.05~0.15	0.10~0.20	0.15~0.25
		Ferritic, martensitic	135~275	CM	PC330N	75 (60~90)	0.10~0.20	0.15~0.30	0.20~0.35
K	Cast iron	Gray cast iron	150~230	CP	PC5335 PC5300	130 (90~140)	0.35~0.45	0.40~0.50	0.45~0.55
		Ductile cast iron	160~260	CP	PC5335 PC5300	120 (80~130)	0.30~0.40	0.30~0.45	0.40~0.50
N	Non-ferrous metal	Aluminum	30~150	CN	H01	200 (120~220)	0.35~0.45	0.40~0.50	0.45~0.55
		Copper alloy	150~160	CN	H01	200 (120~220)	0.35~0.45	0.40~0.50	0.45~0.55

※ In interrupted machining, reduce the feed to 0.1-0.15 machining around the interrupted part

※ In stainless steel machining, start with low feed machining then, gradually get the cutting conditions higher and set the optimal cutting conditions

• 5D Drilling

Workpiece			Insert	Grade	vc (m/min)	Aspect ratio (L/D) = 5D			
ISO	Workpiece	HB				Feed rate (mm/rev) per drill dia. (mm)			
						Ø12.00~Ø17.99	Ø18.00~Ø25.99	Ø26.00~Ø30.99	
P	Carbon steel	Low carbon steel	80~120	CP	PC5335 PC330P	110 (80~140)	0.15~0.30	0.20~0.35	0.25~0.40
		High carbon steel	180~280	CP	PC5335 PC330P	100 (70~130)	0.15~0.30	0.20~0.35	0.25~0.40
	Alloy steel	Low alloy steel	140~260	CP	PC5335 PC5300	110 (80~140)	0.18~0.35	0.23~0.38	0.28~0.43
		Low alloy heat-treated steel	200~400	CP	PC5335 PC5300	75 (50~100)	0.18~0.35	0.23~0.38	0.28~0.43
		High alloy steel	260~320	CP	PC5335 PC5300	70 (50~90)	0.18~0.30	0.20~0.35	0.25~0.40
		High alloy heat-treated steel	300~450	CP	PC5335 PC5300	60 (40~80)	0.18~0.30	0.20~0.35	0.22~0.40
M	Stainless steel	Austenitic	135~275	CM	PC330N	60 (40~80)	0.05~0.15	0.10~0.20	0.15~0.25
		Ferritic, martensitic	135~275	CM	PC330N	70 (50~90)	0.10~0.20	0.15~0.30	0.20~0.35
K	Cast iron	Gray cast iron	150~230	CP	PC5335 PC5300	120 (80~140)	0.25~0.40	0.30~0.45	0.35~0.50
		Ductile cast iron	160~260	CP	PC5335 PC5300	110 (70~130)	0.20~0.35	0.25~0.40	0.30~0.45
N	Non-ferrous metal	Aluminum	30~150	CN	H01	200 (90~220)	0.35~0.45	0.40~0.50	0.45~0.55
		Copper alloy	150~160	CN	H01	200 (90~220)	0.35~0.45	0.40~0.50	0.45~0.55

※ In interrupted machining, reduce the feed to 0.1-0.15 machining around the interrupted part

※ In stainless steel machining, start with low feed machining then, gradually get the cutting conditions higher and set the optimal cutting conditions

F Technical Information for TPDC Plus Drill

• 8D Drilling

Workpiece			Insert	Grade	vc (m/min)	Aspect ratio (L/D) = 8D			
ISO	Workpiece	HB				Feed rate (mm/rev) per drill dia. (mm)			
						Ø12.00-Ø17.99	Ø18.00-Ø25.99	Ø26.00-Ø30.99	
P	Carbon steel	Low carbon steel	80~120	CP	PC5335 PC330P	100 (70~130)	0.12~0.25	0.17~0.30	0.22~0.35
		High carbon steel	180~280	CP	PC5335 PC330P	90 (60~120)	0.12~0.25	0.17~0.30	0.22~0.35
	Alloy steel	Low alloy steel	140~260	CP	PC5335 PC5300	100 (70~130)	0.15~0.30	0.20~0.33	0.25~0.38
		Low alloy heat-treated steel	200~400	CP	PC5335 PC5300	65 (40~90)	0.15~0.30	0.20~0.33	0.25~0.38
		High alloy steel	260~320	CP	PC5335 PC5300	60 (40~80)	0.15~0.25	0.17~0.30	0.22~0.35
		High alloy heat-treated steel	300~450	CP	PC5335 PC5300	50 (30~70)	0.15~0.25	0.17~0.30	0.22~0.35
M	Stainless steel	Austenitic	135~275	CM	PC330N	50 (30~70)	0.05~0.10	0.05~0.15	0.10~0.20
		Ferritic, martensitic	135~275	CM	PC330N	60 (40~80)	0.05~0.15	0.10~0.25	0.15~0.30
K	Cast iron	Gray cast iron	150~230	CP	PC5335 PC5300	110 (70~130)	0.22~0.35	0.27~0.40	0.32~0.45
		Ductile cast iron	160~260	CP	PC5335 PC5300	100 (60~120)	0.17~0.30	0.22~0.35	0.27~0.40
N	Non-ferrous metal	Aluminum	30~150	CN	H01	190 (80~200)	0.30~0.40	0.35~0.45	0.40~0.50
		Copper alloy	150~160	CN	H01	190 (80~200)	0.30~0.40	0.35~0.45	0.40~0.50

- ※ In interrupted machining, reduce the feed to 0.1-0.15 machining around the interrupted part
- ※ In stainless steel machining, start with low feed machining then, gradually get the cutting conditions higher and set the optimal cutting conditions

• 10D/12D Drilling



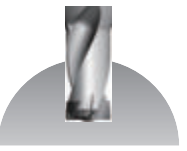


Workpiece			Insert	Grade	vc (m/min)	Aspect ratio (L/D) = 10D, 12D			
ISO	Workpiece	HB				Feed rate (mm/rev) per drill dia. (mm)			
						Ø12.00-Ø17.99	Ø18.00-Ø25.99	Ø26.00-Ø30.99	
P	Carbon steel	Low carbon steel	80~120	CP	PC5335 PC330P	90 (60~120)	0.10~0.20	0.15~0.25	0.20~0.30
		High carbon steel	180~280	CP	PC5335 PC330P	80 (50~110)	0.10~0.20	0.15~0.25	0.20~0.30
	Alloy steel	Low alloy steel	140~260	CP	PC5335 PC5300	90 (60~120)	0.13~0.25	0.18~0.28	0.23~0.33
		Low alloy heat-treated steel	200~400	CP	PC5335 PC5300	55 (40~80)	0.13~0.30	0.18~0.28	0.23~0.33
		High alloy steel	260~320	CP	PC5335 PC5300	50 (40~70)	0.13~0.25	0.15~0.25	0.20~0.30
		High alloy heat-treated steel	300~450	CP	PC5335 PC5300	40 (30~60)	0.13~0.25	0.15~0.25	0.20~0.30
M	Stainless steel	Austenitic	135~275	CM	PC330N	50 (30~60)	0.05~0.10	0.05~0.15	0.10~0.20
		Ferritic, martensitic	135~275	CM	PC330N	60 (40~70)	0.05~0.15	0.10~0.25	0.15~0.30
K	Cast iron	Gray cast iron	150~230	CP	PC5335 PC5300	100 (60~120)	0.20~0.30	0.25~0.35	0.30~0.40
		Ductile cast iron	160~260	CP	PC5335 PC5300	90 (50~110)	0.15~0.25	0.20~0.30	0.25~0.35
N	Non-ferrous metal	Aluminum	30~150	CN	H01	180 (70~190)	0.28~0.35	0.33~0.40	0.38~0.45
		Copper alloy	150~160	CN	H01	180 (70~190)	0.28~0.35	0.33~0.40	0.38~0.45

- ※ In interrupted machining, reduce the feed to 0.1-0.15 machining around the interrupted part
- ※ In case of 10D and 12D, apply the recommended cutting conditions in the other side
- ※ In stainless steel machining, start with low feed machining then, gradually get the cutting conditions higher and set the optimal cutting conditions



Recommended cutting conditions (TPDC-CP-FC)

Workpiece			Grade	vc (m/min)	Aspect ratio (L/D) = 1.5D, 3D, 5D		
ISO	Workpiece	HB			Feed rate (mm/rev) per drill dia. (mm)		
					Ø12.00-Ø17.99	Ø18.00-Ø25.99	Ø26.00-Ø30.99
P	Carbon steel	Low carbon steel (SM10C, SM20C etc)	PC5335	90 (70~110)	0.18~0.28	0.2~0.3	0.23~0.33
		High carbon steel (SM45C, SM50C etc)		80 (60~100)	0.18~0.28	0.2~0.3	0.23~0.33
	Alloy steel	Low alloy steel (SCM420, SCM440 etc)		90 (70~110)	0.18~0.28	0.2~0.3	0.23~0.33
		High alloy steel (SCM435, SCM445 etc)		70 (50~90)	0.18~0.28	0.2~0.3	0.23~0.33

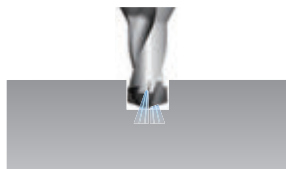
Machining	Flat surface drilling	Angled surface drilling	Curved surface drilling	Plunging	Boring
Pic.					
1.5D/3D	○	○	○	○	○
5D	○	×	×	×	×

※ Please refer to the precaution in drilling in case of angled surface drilling, curved surface drilling, plunging and boring

How to drill a deep hole (10D/12D)

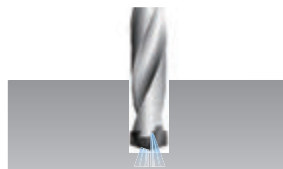
• Using a pilot drill (recommended)

1. Drilling a pilot hole (with a pilot drill)



- Drill a 0.5D pilot hole in 70% lower cutting speed with 1.5D drill or 3D drill

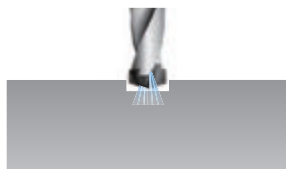
2. Start drilling



- Start drilling in recommended cutting conditions after replacing the drill

• Without pilot drill

1. Drilling a pilot hole (without a pilot drill)



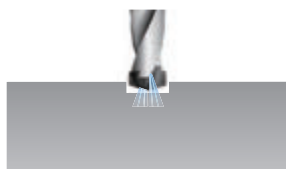
- After drill 0.5D with 70% lower cutting speed, stop drilling for 2-3 seconds putting the drill in the hole

2. Stop drilling



- Stop supplying the coolant and take out the drill from the hole. Then, stop drilling for 2-3 seconds

3. Ready to drill



- After putting the drill in the hole to 2-3 mm upper than the bottom of the pilot hole, start supplying the coolant. Then, be ready to start drilling

4. Stop drilling



- Start drilling in recommended cutting conditions

F Technical Information for TPDC Plus Drill

Precaution in drilling

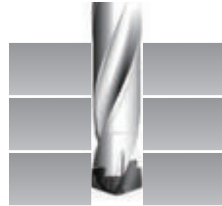
• TPDC-CP/CM/CN

Angled surface drilling



- The approach angle between drill and the workpiece at the beginning and the end should be less than 6°
- Reduce the feed (fn) to 30-50% than general cutting conditions at the beginning and the end of angled surface

Stacked plates drilling



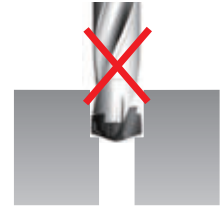
- Gap between the plates could make wrong chip evacuation causing fracture of the drill
- Place stacked plates without any gap between each

Plunging



- Irregular cutting resistance in plunging could cause fracture and deformation of the drill

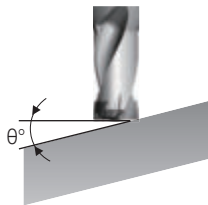
Boring



- Boring is not recommended due to wear and chipping in the corner of the insert

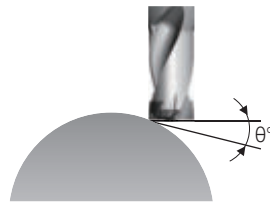
• TPDC-CP-FC

Angled surface drilling



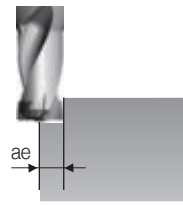
- Reduce the feed (fn) to 30% than general cutting conditions at the beginning and the end of angled surface (Recommended only in case of θ is less than 10°)

Curved surface drilling



- Reduce the feed (fn) to 30% than general cutting conditions at the beginning of curved surface (In case, θ is over 30° , reduce it to 50%)

Plunging



- Reduce the depth of cut (ae) to shorter than 1/2 of drill diameter
- In case, the depth of cut is longer than drill diameter, plunge with divided depth of cut

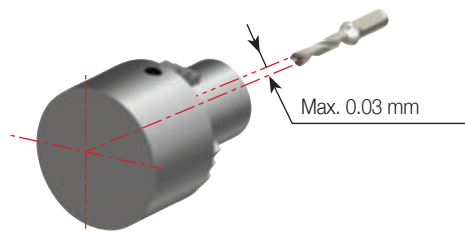
Boring



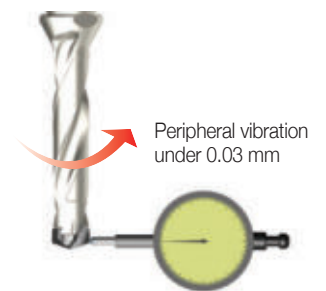
- Reduce the feed (fn) to 30% than general cutting conditions at the beginning of boring
- Start with 2 mm stepping before boring to prevent long chip

Check point in drilling

- Condition of the clamped workpiece
- Revolution of the main axis of the machine
- Condition of the holder
- Run-out of the clamped drill (Max. 0.03 mm)
- Condition of supplying coolant (pressure, flow, concentration)
- Chip evacuation



Setting of the horizontal equipment



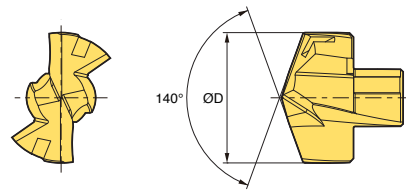
Setting of the vertical equipment

Supply of coolant

- Supply enough coolant to the beginning of the hole
- Minimum pressure of oil coolant: 5 bar
- Minimum flow of coolant: 5 l/min



Available insert



Drill dia. ØD (mm)	P type (XP)	Coated	Holder	Wrench
	TPDC-XP	PC325U		
8.0	TPD0800XP	●	TPDX□D-08012-□	TPDC -W0811
8.1	TPD0810XP	●		
8.2	TPD0820XP	●		
8.3	TPD0830XP	●		
8.4	TPD0840XP	●	TPDX□D-08512-□	
8.5	TPD0850XP	●		
8.6	TPD0860XP	●		
8.7	TPD0870XP	●		
8.8	TPD0880XP	●		
8.9	TPD0890XP	●	TPDX□D-09012-□	
9.0	TPD0900XP	●		
9.1	TPD0910XP	●		
9.2	TPD0920XP	●		
9.3	TPD0930XP	●	TPDX□D-09512-□	
9.4	TPD0940XP	●		
9.5	TPD0950XP	●		
9.6	TPD0960XP	●		
9.7	TPD0970XP	●		
9.8	TPD0980XP	●	TPDX□D-10016-□	
9.9	TPD0990XP	●		
10.0	TPD1000XP	●		
10.1	TPD1010XP	●		
10.2	TPD1020XP	●	TPDX□D-10516-□	
10.3	TPD1030XP	●		
10.4	TPD1040XP	●		
10.5	TPD1050XP	●		
10.6	TPD1060XP	●		
10.7	TPD1070XP	●	TPDX□D-11016-□	
10.8	TPD1080XP	●		
10.9	TPD1090XP	●		
11.0	TPD1100XP	●		
11.1	TPD1110XP	●	TPDX□D-11516-□	
11.2	TPD1120XP	●		
11.3	TPD1130XP	●		
11.4	TPD1140XP	●		
11.5	TPD1150XP	●		
11.6	TPD1160XP	●	TPDX□D-11516-□	
11.7	TPD1170XP	●		
11.8	TPD1180XP	●		
11.9	TPD1190XP	●		

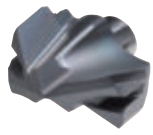
※ We can provide if you order exact machining specification

● : Stock Item

Parts (applicable wrench)

Picture	Designation	Drill diameter ØD (mm)	Torque (N·m)
	TPDC-W0811	8.00-11.99	0.7-1.5

Available insert



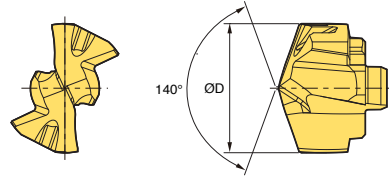
CP



CM



CN



Drill dia. ØD(mm)	P type (CP)				M type (CM)		N type (CN)		Holder	Wrench
	TPDC-CP	Coated			TPDC-CM	Coated	TPDC-CN	Uncoated		
		PC5335	PC5300	PC330P		PC330N		H01		
12.0	TPD1200CP	●			TPD1200CM	●	TPD1200CN		TPDC- W1216	
12.2	TPD1220CP	●			TPD1220CM	●	TPD1220CN			
12.5	TPD1250CP	●			TPD1250CM	●	TPD1250CN			
12.6	TPD1260CP	●			TPD1260CM	●	TPD1260CN			
13.0	TPD1300CP	●			TPD1300CM	●	TPD1300CN			
13.5	TPD1350CP	●			TPD1350CM	●	TPD1350CN			
14.0	TPD1400CP	●			TPD1400CM	●	TPD1400CN			
14.2	TPD1420CP	●			TPD1420CM	●	TPD1420CN			
14.3	TPD1430CP	●			TPD1430CM	●	TPD1430CN			
14.5	TPD1450CP	●			TPD1450CM	●	TPD1450CN			
15.0	TPD1500CP	●			TPD1500CM	●	TPD1500CN			
15.2	TPD1520CP	●			TPD1520CM	●	TPD1520CN			
15.5	TPD1550CP	●			TPD1550CM	●	TPD1550CN			
16.0	TPD1600CP	●			TPD1600CM	●	TPD1600CN			
16.3	TPD1630CP	●			TPD1630CM	●	TPD1630CN			
16.5	TPD1650CP	●			TPD1650CM	●	TPD1650CN			
16.7	TPD1670CP	●			TPD1670CM	●	TPD1670CN			
16.9	TPD1690CP	●			TPD1690CM	●	TPD1690CN			
17.0	TPD1700CP	●			TPD1700CM	●	TPD1700CN			
17.5	TPD1750CP	●			TPD1750CM	●	TPD1750CN			
17.7	TPD1770CP	●			TPD1770CM	●	TPD1770CN			
18.0	TPD1800CP	●			TPD1800CM	●	TPD1800CN			
18.1	TPD1810CP	●			TPD1810CM	●	TPD1810CN			
18.5	TPD1850CP	●			TPD1850CM	●	TPD1850CN			
18.6	TPD1860CP	●			TPD1860CM	●	TPD1860CN			
18.7	TPD1870CP	●			TPD1870CM	●	TPD1870CN			
19.0	TPD1900CP	●			TPD1900CM	●	TPD1900CN			
19.2	TPD1920CP	●			TPD1920CM	●	TPD1920CN			
19.3	TPD1930CP	●			TPD1930CM	●	TPD1930CN			
19.5	TPD1950CP	●			TPD1950CM	●	TPD1950CN			
19.7	TPD1970CP	●			TPD1970CM	●	TPD1970CN			
20.0	TPD2000CP	●			TPD2000CM	●	TPD2000CN			
20.5	TPD2050CP	●			TPD2050CM	●	TPD2050CN			
21.0	TPD2100CP	●			TPD2100CM	●	TPD2100CN			
21.5	TPD2150CP	●			TPD2150CM	●	TPD2150CN			
22.0	TPD2200CP	●			TPD2200CM	●	TPD2200CN			
22.5	TPD2250CP	●			TPD2250CM	●	TPD2250CN			
22.6	TPD2260CP	●			TPD2260CM	●	TPD2260CN			
22.7	TPD2270CP	●			TPD2270CM	●	TPD2270CN			
23.0	TPD2300CP	●			TPD2300CM	●	TPD2300CN			
23.5	TPD2350CP	●			TPD2350CM	●	TPD2350CN			
24.0	TPD2400CP	●			TPD2400CM	●	TPD2400CN			
24.5	TPD2450CP	●			TPD2450CM	●	TPD2450CN			
25.0	TPD2500CP	●			TPD2500CM	●	TPD2500CN			
25.3	TPD2530CP	●			TPD2530CM	●	TPD2530CN			
25.5	TPD2550CP	●			TPD2550CM	●	TPD2550CN			
25.8	TPD2580CP	●			TPD2580CM	●	TPD2580CN			
25.9	TPD2590CP	●			TPD2590CM	●	TPD2590CN			
26.0	TPD2600CP	●			TPD2600CM	●	TPD2600CN			
26.5	TPD2650CP	●			TPD2650CM	●	TPD2650CN			
27.0	TPD2700CP	●			TPD2700CM	●	TPD2700CN			
27.5	TPD2750CP	●			TPD2750CM	●	TPD2750CN			
28.0	TPD2800CP	●			TPD2800CM	●	TPD2800CN			
28.5	TPD2850CP	●			TPD2850CM	●	TPD2850CN			
29.0	TPD2900CP	●			TPD2900CM	●	TPD2900CN			
29.5	TPD2950CP	●			TPD2950CM	●	TPD2950CN			
30.0	TPD3000CP	●			TPD3000CM	●	TPD3000CN			
30.5	TPD3050CP	●			TPD3050CM	●	TPD3050CN			

※ We can provide if you order exact machining specification Ex) Ø15.9 and carbon steel machining → TPDC1590CP/PC330P

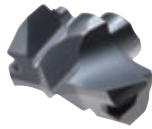
●: Stock Item

Parts (applicable wrench)

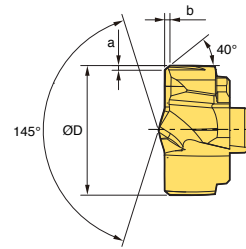
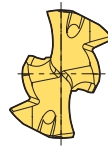
Picture	Designation	Drill diameter ØD (mm)	Torque (N·m)
	TPDC- W1216	12.00-16.99	2.0-3.0
	W1721	17.00-21.99	2.0-4.0
	W2225	22.00-25.99	3.0-4.0
	W2630	26.00-30.99	4.0-5.0



Available insert



FC



Drill dia. ØD(mm)	FC type (CP-FC)		Holder	Chamfer (mm)		Wrench
	TPDC-CP-FC	Coated PC5335		a	b	
12.0	TPD1200CP-FC		TPDC□D-12016-□	0.38	0.45	TPDC-W1216
12.2	TPD1220CP-FC					
12.5	TPD1250CP-FC		TPDC□D-12516-□			
12.6	TPD1260CP-FC					
13.0	TPD1300CP-FC		TPDC□D-13016-□			
13.5	TPD1350CP-FC		TPDC□D-13516-□			
14.0	TPD1400CP-FC					
14.2	TPD1420CP-FC		TPDC□D-14016-□			
14.3	TPD1430CP-FC					
14.5	TPD1450CP-FC		TPDC□D-14516-□			
15.0	TPD1500CP-FC		TPDC□D-15020-□			
15.5	TPD1550CP-FC					
16.0	TPD1600CP-FC					
16.3	TPD1630CP-FC		TPDC□D-16020-□			
16.5	TPD1650CP-FC					
16.7	TPD1670CP-FC					
17.0	TPD1700CP-FC					
17.5	TPD1750CP-FC		TPDC□D-17020-□	0.46	0.55	TPDC-W1721
17.7	TPD1770CP-FC					
18.0	TPD1800CP-FC		TPDC□D-18025-□			
18.1	TPD1810CP-FC					
18.5	TPD1850CP-FC					
18.6	TPD1860CP-FC					
18.7	TPD1870CP-FC					
19.0	TPD1900CP-FC					
19.2	TPD1920CP-FC		TPDC□D-19025-□			
19.5	TPD1950CP-FC					
19.7	TPD1970CP-FC					
20.0	TPD2000CP-FC		TPDC□D-20025-□			
20.5	TPD2050CP-FC					
21.0	TPD2100CP-FC		TPDC□D-21025-□			
21.5	TPD2150CP-FC					
22.0	TPD2200CP-FC					
22.5	TPD2250CP-FC		TPDC□D-22025-□			
22.6	TPD2260CP-FC					
22.7	TPD2270CP-FC					
23.0	TPD2300CP-FC		TPDC□D-23025-□			
23.5	TPD2350CP-FC					
24.0	TPD2400CP-FC		TPDC□D-24032-□			
24.5	TPD2450CP-FC					
25.0	TPD2500CP-FC					
25.3	TPD2530CP-FC		TPDC□D-25032-□			
25.5	TPD2550CP-FC					
25.8	TPD2580CP-FC					
25.9	TPD2590CP-FC					
26.0	TPD2600CP-FC					
26.5	TPD2650CP-FC		TPDC□D-26032-□	0.54	0.65	TPDC-W2630
26.5	TPD2650CP-FC					
27.0	TPD2700CP-FC		TPDC□D-27032-□			
27.5	TPD2750CP-FC					
28.0	TPD2800CP-FC		TPDC□D-28032-□			
28.5	TPD2850CP-FC					
29.0	TPD2900CP-FC		TPDC□D-29032-□			
29.5	TPD2950CP-FC					
30.0	TPD3000CP-FC					
30.5	TPD3050CP-FC		TPDC□D-30032-□			

※ We can provide if you order exact machining specification Ex) Ø15.9 and carbon steel machining → TPD1590CP-FC/PC5335

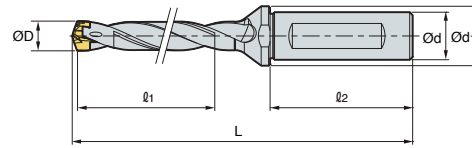
● : Stock Item

※ TPDC-CP-FC insert: impossible to be reground

Parts (applicable wrench)

Picture	Designation	Drill diameter ØD (mm)	Torque (N·m)
	TPDC- W1216	12.00-16.99	2.0-3.0
	W1721	17.00-21.99	2.0-4.0
	W2225	22.00-25.99	3.0-4.0
	W2630	26.00-30.99	4.0-5.0

TPDX (3D/5D/8D)



(mm)

Designation		ØD	Ød	Ød ₁	l ₁	l ₂	L	Insert
TPDX	3D-08012-24	8.0-8.4	12	16	24	45	82.2	TPD0800XP-0849XP
	3D-08512-26	8.5-8.9	12	16	26	45	84.1	TPD0850XP-0899XP
	3D-09012-27	9.0-9.4	12	16	27	45	85.9	TPD0900XP-0949XP
	3D-09512-29	9.5-9.9	12	16	29	45	87.7	TPD0950XP-0999XP
	3D-10016-30	10.0-10.4	16	20	30	48	94.6	TPD1000XP-1049XP
	3D-10516-32	10.5-10.9	16	20	32	48	96.5	TPD1050XP-1099XP
	3D-11016-33	11.0-11.4	16	20	33	48	98.2	TPD1100XP-1149XP
	3D-11516-35	11.5-11.9	16	20	35	48	100.1	TPD1150XP-1199XP
TPDX	5D-08012-40	8.0-8.4	12	16	40	45	98.2	TPD0800XP-0849XP
	5D-08512-43	8.5-8.9	12	16	43	45	101.1	TPD0850XP-0899XP
	5D-09012-45	9.0-9.4	12	16	45	45	103.9	TPD0900XP-0949XP
	5D-09512-48	9.5-9.9	12	16	48	45	106.7	TPD0950XP-0999XP
	5D-10016-50	10.0-10.4	16	20	50	48	114.6	TPD1000XP-1049XP
	5D-10516-53	10.5-10.9	16	20	53	48	117.5	TPD1050XP-1099XP
	5D-11016-55	11.0-11.4	16	20	55	48	120.2	TPD1100XP-1149XP
	5D-11516-58	11.5-11.9	16	20	58	48	123.1	TPD1150XP-1199XP
TPDX	8D-08012-64	8.0-8.4	12	16	64	45	122.2	TPD0800XP-0849XP
	8D-08512-68	8.5-8.9	12	16	68	45	126.6	TPD0850XP-0899XP
	8D-09012-72	9.0-9.4	12	16	72	45	130.9	TPD0900XP-0949XP
	8D-09512-76	9.5-9.9	12	16	76	45	135.2	TPD0950XP-0999XP
	8D-10016-80	10.0-10.4	16	20	80	48	144.6	TPD1000XP-1049XP
	8D-10516-84	10.5-10.9	16	20	84	48	149.0	TPD1050XP-1099XP
	8D-11016-88	11.0-11.4	16	20	88	48	153.2	TPD1100XP-1149XP
	8D-11516-92	11.5-11.9	16	20	92	48	157.6	TPD1150XP-1199XP

↻ Applicable inserts **F47**

※ We can provide if you order exact machining specification. Ex) Ø10 and 60 mm depth of cut → TPDX6D-10016-60



TPDC (1.5D/3D)

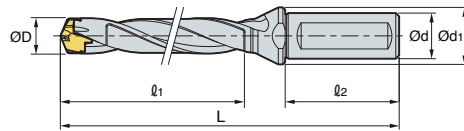


Fig.1

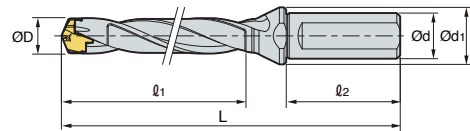


Fig.2

		(mm)							
	Designation	ØD	Ød	Ød ₁	l ₁	l ₂	L	Insert	Fig.
TPDC	1.5D-12016-18	12.0~12.4	16	20	18	48	85	TPD1200C□-1249C□	1
	1.5D-12516-19	12.5~12.9	16	20	19	48	86	TPD1250C□-1299C□	1
	1.5D-13016-20	13.0~13.4	16	20	20	48	87	TPD1300C□-1349C□	1
	1.5D-13516-20	13.5~13.9	16	20	20	48	88	TPD1350C□-1399C□	1
	1.5D-14016-21	14.0~14.4	16	20	21	48	93	TPD1400C□-1449C□	1
	1.5D-14516-22	14.5~14.9	16	20	22	48	94	TPD1450C□-1499C□	1
	1.5D-15020-23	15.0~15.9	20	25	23	50	95	TPD1500C□-1599C□	2
	1.5D-16020-24	16.0~16.9	20	25	24	50	98	TPD1600C□-1699C□	2
	1.5D-17020-26	17.0~17.9	20	25	26	50	100	TPD1700C□-1799C□	2
	1.5D-18025-27	18.0~18.9	25	33	27	56	110	TPD1800C□-1899C□	2
	1.5D-19025-28	19.0~19.9	25	33	28	56	112	TPD1900C□-1999C□	2
	1.5D-20025-30	20.0~20.9	25	33	30	56	114	TPD2000C□-2099C□	2
	1.5D-21025-31	21.0~21.9	25	33	31	56	116	TPD2100C□-2199C□	2
	1.5D-22025-33	22.0~22.9	25	33	33	56	119	TPD2200C□-2299C□	2
	1.5D-23025-34	23.0~23.9	25	33	34	56	121	TPD2300C□-2399C□	2
	1.5D-24032-36	24.0~24.9	32	43	36	60	130	TPD2400C□-2499C□	2
	1.5D-25032-37	25.0~25.9	32	43	37	60	132	TPD2500C□-2599C□	2
1.5D-26032-39	26.0~26.9	32	43	39	60	134	TPD2600C□-2699C□	2	
1.5D-27032-40	27.0~27.9	32	43	40	60	136	TPD2700C□-2799C□	2	
1.5D-28032-42	28.0~28.9	32	43	42	60	138	TPD2800C□-2899C□	2	
1.5D-29032-43	29.0~29.9	32	43	43	60	141	TPD2900C□-2999C□	2	
1.5D-30032-45	30.0~30.9	32	43	45	60	143	TPD3000C□-3099C□	2	
TPDC	3D-12016-36	12.0~12.4	16	20	36	48	99	TPD1200C□-1249C□	1
	3D-12516-38	12.5~12.9	16	20	38	48	101	TPD1250C□-1299C□	1
	3D-13016-39	13.0~13.4	16	20	39	48	103	TPD1300C□-1349C□	1
	3D-13516-41	13.5~13.9	16	20	41	48	105	TPD1350C□-1399C□	1
	3D-14016-42	14.0~14.4	16	20	42	48	106	TPD1400C□-1449C□	1
	3D-14516-44	14.5~14.9	16	20	44	48	107	TPD1450C□-1499C□	1
	3D-15020-45	15.0~15.9	20	25	45	50	113	TPD1500C□-1599C□	2
	3D-16020-48	16.0~16.9	20	25	48	50	117	TPD1600C□-1699C□	2
	3D-17020-51	17.0~17.9	20	25	51	50	120	TPD1700C□-1799C□	2
	3D-18025-54	18.0~18.9	25	33	54	56	132	TPD1800C□-1899C□	2
	3D-19025-57	19.0~19.9	25	33	57	56	135	TPD1900C□-1999C□	2
	3D-20025-60	20.0~20.9	25	33	60	56	138	TPD2000C□-2099C□	2
	3D-21025-63	21.0~21.9	25	33	63	56	141	TPD2100C□-2199C□	2
	3D-22025-66	22.0~22.9	25	33	66	56	145	TPD2200C□-2299C□	2
	3D-23025-69	23.0~23.9	25	33	69	56	149	TPD2300C□-2399C□	2
	3D-24032-72	24.0~24.9	32	43	72	60	159	TPD2400C□-2499C□	2
	3D-25032-75	25.0~25.9	32	43	75	60	162	TPD2500C□-2599C□	2
	3D-26032-78	26.0~26.9	32	43	78	60	173	TPD2600C□-2699C□	2
	3D-27032-81	27.0~27.9	32	43	81	60	176	TPD2700C□-2799C□	2
	3D-28032-84	28.0~28.9	32	43	84	60	180	TPD2800C□-2899C□	2
	3D-29032-87	29.0~29.9	32	43	87	60	185	TPD2900C□-2999C□	2
3D-30032-90	30.0~30.9	32	43	90	60	188	TPD3000C□-3099C□	2	

➔ Applicable inserts F48~49

※ We can provide if you order exact machining specification. Ex) Ø15 and 60 mm depth of cut → TPDC4D-15020-60

TPDC (5D/8D)

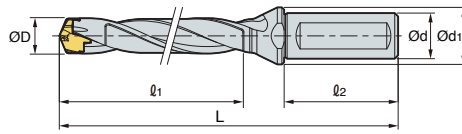


Fig.1

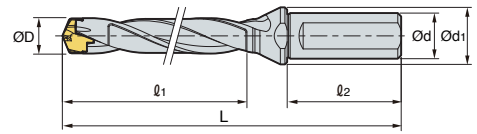


Fig.2

(mm)

	Designation	ØD	Ød	Ød ₁	l ₁	l ₂	L	Insert	Fig.
TPDC	5D-12016-60	12.0~12.4	16	20	60	48	123	TPD1200C□-1249C□	1
	5D-12516-63	12.5~12.9	16	20	63	48	126	TPD1250C□-1299C□	1
	5D-13016-65	13.0~13.4	16	20	65	48	129	TPD1300C□-1349C□	1
	5D-13516-68	13.5~13.9	16	20	68	48	132	TPD1350C□-1399C□	1
	5D-14016-70	14.0~14.4	16	20	70	48	134	TPD1400C□-1449C□	1
	5D-14516-73	14.5~14.9	16	20	73	48	136	TPD1450C□-1499C□	1
	5D-15020-75	15.0~15.9	20	25	75	50	143	TPD1500C□-1599C□	2
	5D-16020-80	16.0~16.9	20	25	80	50	149	TPD1600C□-1699C□	2
	5D-17020-85	17.0~17.9	20	25	85	50	154	TPD1700C□-1799C□	2
	5D-18025-90	18.0~18.9	25	33	90	56	168	TPD1800C□-1899C□	2
	5D-19025-95	19.0~19.9	25	33	95	56	173	TPD1900C□-1999C□	2
	5D-20025-100	20.0~20.9	25	33	100	56	178	TPD2000C□-2099C□	2
	5D-21025-105	21.0~21.9	25	33	105	56	183	TPD2100C□-2199C□	2
	5D-22025-110	22.0~22.9	25	33	110	56	189	TPD2200C□-2299C□	2
	5D-23025-115	23.0~23.9	25	33	115	56	195	TPD2300C□-2399C□	2
	5D-24032-120	24.0~24.9	32	43	120	60	207	TPD2400C□-2499C□	2
	5D-25032-125	25.0~25.9	32	43	125	60	212	TPD2500C□-2599C□	2
5D-26032-130	26.0~26.9	32	43	130	60	225	TPD2600C□-2699C□	2	
5D-27032-135	27.0~27.9	32	43	135	60	230	TPD2700C□-2799C□	2	
5D-28032-140	28.0~28.9	32	43	140	60	236	TPD2800C□-2899C□	2	
5D-29032-145	29.0~29.9	32	43	145	60	243	TPD2900C□-2999C□	2	
5D-30032-150	30.0~30.9	32	43	150	60	248	TPD3000C□-3099C□	2	
TPDC	8D-12016-96	12.0~12.4	16	20	96	48	159	TPD1200C□-1249C□	1
	8D-12516-100	12.5~12.9	16	20	100	48	163	TPD1250C□-1299C□	1
	8D-13016-104	13.0~13.4	16	20	104	48	168	TPD1300C□-1349C□	1
	8D-13516-108	13.5~13.9	16	20	108	48	173	TPD1350C□-1399C□	1
	8D-14016-112	14.0~14.4	16	20	112	48	176	TPD1400C□-1449C□	1
	8D-14516-116	14.5~14.9	16	20	116	48	180	TPD1450C□-1499C□	1
	8D-15020-120	15.0~15.9	20	25	120	50	188	TPD1500C□-1599C□	2
	8D-16020-128	16.0~16.9	20	25	128	50	197	TPD1600C□-1699C□	2
	8D-17020-136	17.0~17.9	20	25	136	50	205	TPD1700C□-1799C□	2
	8D-18025-144	18.0~18.9	25	33	144	56	222	TPD1800C□-1899C□	2
	8D-19025-152	19.0~19.9	25	33	152	56	230	TPD1900C□-1999C□	2
	8D-20025-160	20.0~20.9	25	33	160	56	238	TPD2000C□-2099C□	2
	8D-21025-168	21.0~21.9	25	33	168	56	246	TPD2100C□-2199C□	2
	8D-22025-176	22.0~22.9	25	33	176	56	255	TPD2200C□-2299C□	2
	8D-23025-184	23.0~23.9	25	33	184	56	264	TPD2300C□-2399C□	2
	8D-24032-192	24.0~24.9	32	43	192	60	279	TPD2400C□-2499C□	2
	8D-25032-200	25.0~25.9	32	43	200	60	287	TPD2500C□-2599C□	2
	8D-26032-208	26.0~26.9	32	43	208	60	303	TPD2600C□-2699C□	2
	8D-27032-216	27.0~27.9	32	43	216	60	311	TPD2700C□-2799C□	2
	8D-28032-224	28.0~28.9	32	43	224	60	320	TPD2800C□-2899C□	2
	8D-29032-232	29.0~29.9	32	43	232	60	330	TPD2900C□-2999C□	2
	8D-30032-240	30.0~30.9	32	43	240	60	338	TPD3000C□-3099C□	2

Applicable inserts F48~49

※ We can provide if you order exact machining specification. Ex) Ø15 and 60 mm depth of cut → TPDC4D-15020-60



TPDC (10D/12D)

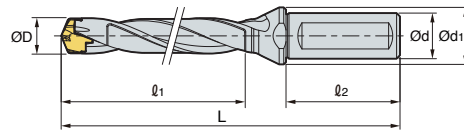


Fig.1

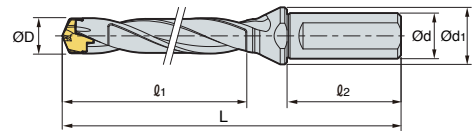


Fig.2

		(mm)							
	Designation	ØD	Ød	Ød ₁	l ₁	l ₂	L	Insert	Fig.
TPDC	10D-12016-120	12.0~12.4	16	20	120	48	183	TPD1200C□-1249C□	1
	10D-12516-125	12.5~12.9	16	20	125	48	188	TPD1250C□-1299C□	1
	10D-13016-130	13.0~13.4	16	20	130	48	194	TPD1300C□-1349C□	1
	10D-13516-135	13.5~13.9	16	20	135	48	199	TPD1350C□-1399C□	1
	10D-14016-140	14.0~14.4	16	20	140	48	204	TPD1400C□-1449C□	1
	10D-14516-145	14.5~14.9	16	20	145	48	208	TPD1450C□-1499C□	1
	10D-15020-150	15.0~15.9	20	25	150	50	218	TPD1500C□-1599C□	1
	10D-16020-160	16.0~16.9	20	25	160	50	229	TPD1600C□-1699C□	1
	10D-17020-170	17.0~17.9	20	25	170	50	239	TPD1700C□-1799C□	1
	10D-18025-180	18.0~18.9	25	33	180	56	258	TPD1800C□-1899C□	1
	10D-19025-190	19.0~19.9	25	33	190	56	268	TPD1900C□-1999C□	1
	10D-20025-200	20.0~20.9	25	33	200	56	278	TPD2000C□-2099C□	1
	10D-21025-210	21.0~21.9	25	33	210	56	288	TPD2100C□-2199C□	1
	10D-22025-220	22.0~22.9	25	33	220	56	299	TPD2200C□-2299C□	1
	10D-23025-230	23.0~23.9	25	33	230	56	310	TPD2300C□-2399C□	1
	10D-24032-240	24.0~24.9	32	43	240	60	327	TPD2400C□-2499C□	2
	10D-25032-250	25.0~25.9	32	43	250	60	337	TPD2500C□-2599C□	2
	10D-26032-260	26.0~26.9	32	43	260	60	355	TPD2600C□-2699C□	2
10D-27032-270	27.0~27.9	32	43	270	60	365	TPD2700C□-2799C□	2	
10D-28032-280	28.0~28.9	32	43	280	60	376	TPD2800C□-2899C□	2	
10D-29032-290	29.0~29.9	32	43	290	60	388	TPD2900C□-2999C□	2	
10D-30032-300	30.0~30.9	32	43	300	60	398	TPD3000C□-3099C□	2	
TPDC	12D-12016-144	12.0~12.4	16	20	144	48	207	TPD1200C□-1249C□	1
	12D-12516-150	12.5~12.9	16	20	150	48	213	TPD1250C□-1299C□	1
	12D-13016-156	13.0~13.4	16	20	156	48	220	TPD1300C□-1349C□	1
	12D-13516-162	13.5~13.9	16	20	162	48	226	TPD1350C□-1399C□	1
	12D-14016-168	14.0~14.4	16	20	168	48	232	TPD1400C□-1449C□	1
	12D-14516-174	14.5~14.9	16	20	174	48	237	TPD1450C□-1499C□	1
	12D-15020-180	15.0~15.9	20	25	180	50	248	TPD1500C□-1599C□	1
	12D-16020-192	16.0~16.9	20	25	192	50	261	TPD1600C□-1699C□	1
	12D-17020-204	17.0~17.9	20	25	204	50	273	TPD1700C□-1799C□	1
	12D-18025-216	18.0~18.9	25	33	216	56	294	TPD1800C□-1899C□	1
	12D-19025-228	19.0~19.9	25	33	228	56	306	TPD1900C□-1999C□	1
	12D-20025-240	20.0~20.9	25	33	240	56	318	TPD2000C□-2099C□	1
	12D-21025-252	21.0~21.9	25	33	252	56	330	TPD2100C□-2199C□	1
	12D-22025-264	22.0~22.9	25	33	264	56	343	TPD2200C□-2299C□	1
	12D-23025-276	23.0~23.9	25	33	276	56	356	TPD2300C□-2399C□	1
	12D-24032-288	24.0~24.9	32	43	288	60	375	TPD2400C□-2499C□	2
	12D-25032-300	25.0~25.9	32	43	300	60	387	TPD2500C□-2599C□	2
	12D-26032-312	26.0~26.9	32	43	312	60	407	TPD2600C□-2699C□	2
	12D-27032-324	27.0~27.9	32	43	324	60	419	TPD2700C□-2799C□	2
	12D-28032-336	28.0~28.9	32	43	336	60	432	TPD2800C□-2899C□	2
12D-29032-348	29.0~29.9	32	43	348	60	446	TPD2900C□-2999C□	2	
12D-30032-360	30.0~30.9	32	43	360	60	458	TPD3000C□-3099C□	2	

↻ Applicable inserts F48~49

We can provide if you order exact machining specification. Ex) Ø15 and 135 mm depth of cut → TPDC9D-15020-135



F Technical Information for TPDB Plus Drill

Highly precise and efficient top solid indexable drill

TPDB Plus Drill

(TPDB Plus / TPDB-F ^{new} / TPDB-H ^{new})

- Highly precise clamping system - Superior clamping precision with auto-centering system and highly precise grinding clamping parts
- Screw on clamping system - Easy to replace inserts
- Sharp cutting edge - Low cutting load and good chip control
- Holder with excellent durability - Holder with high rigidity and excellent wear resistance due to special surface treatment
- Holder with excellent chip control - Low cutting resistance and outstanding chip evaluation applying high helix angle

Code system

• Insert



• Holder



Features

Special surface treatment
• Improved durability of a holder

Auto-centering system

Screw on clamping system

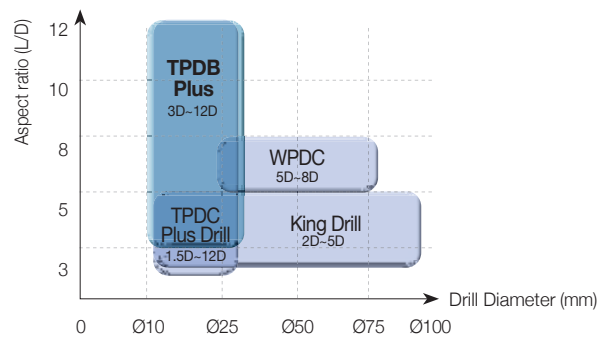
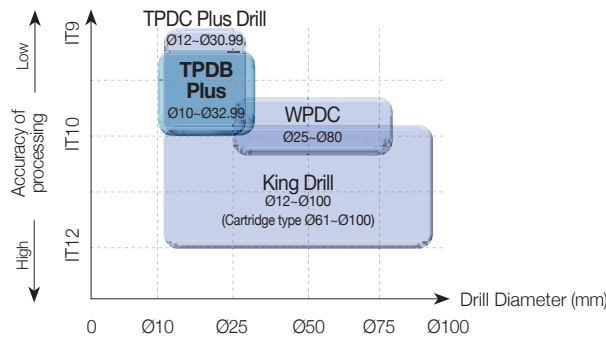
High helix angle
• High productivity
- Stable chip evacuation realizes stable machinability
- Decreased cycle time by applying improved cutting conditions
• Improvement in machining quality
- Good surface finish and regular size of the hole

20% higher productivity
← Applying flute with higher helix angle than TPDB's

Advanced chip control due to a chip breaker

Cutting edge with low cutting resistance
• Low cutting load and excellent chip control

Application range

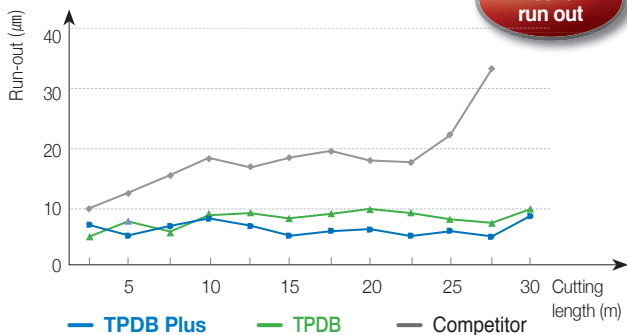


Tools	Application range					
	Drill Diameter (Ø)	Aspect ratio (L/D)	Tolerance of drill dia.	Tolerance of hole	Surface finish of hole (Ra)	Workpiece material
TPDB Plus	10~32.99 mm	3, 5, 8, 10, 12	h7	IT10	≤ 2.0 μm	P, K

Performance evaluation

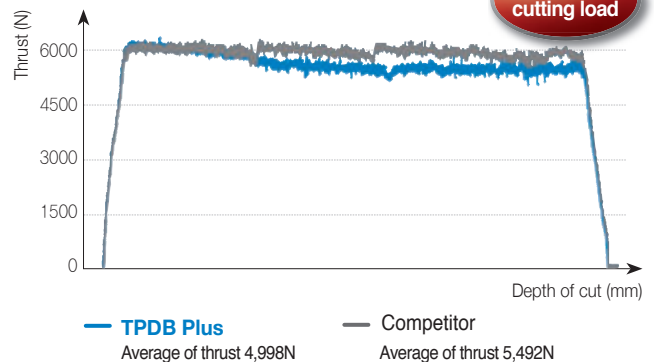
Run-out

- Workpiece Alloy steel (SCM440)
- Cutting conditions vc (m/min) = 90, fn (mm/rev) = 0.25, ap (mm) = 120, wet (20 bar)
- Tools Insert TPD250B (PC5300)
Holder TPDB250-32-5-P (Drill dia. = Ø25 mm)



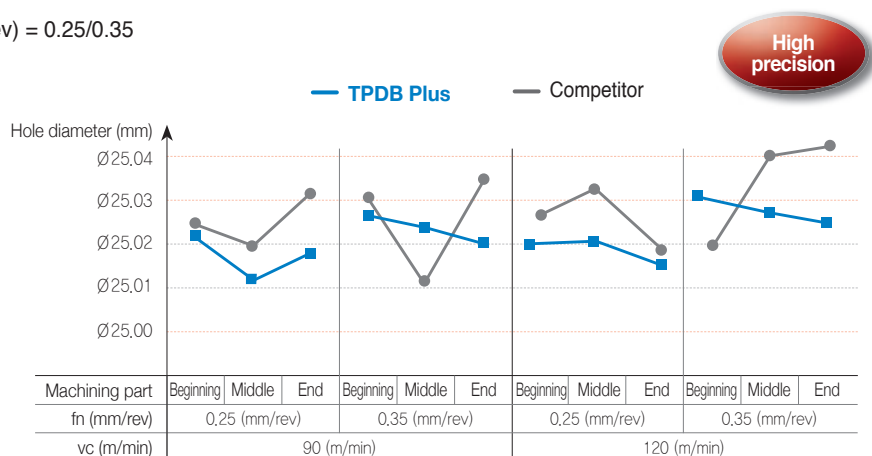
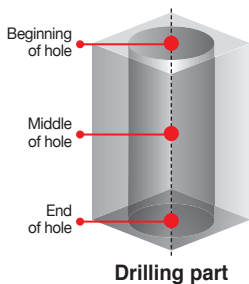
Cutting load

- Workpiece Alloy steel (SCM440)
- Cutting conditions vc (m/min) = 120, fn (mm/rev) = 0.25, ap (mm) = 120, wet (20 bar)
- Tools Insert TPD250B (PC5300)
Holder TPDB250-32-5-P (Drill dia. = Ø25 mm)



Outstanding roundness of hole

- Workpiece Alloy steel (SCM440)
- Cutting conditions vc (m/min) = 90/120, fn (mm/rev) = 0.25/0.35, ap (mm) = 120, wet (20 bar)
- Tools Insert TPD250B (PC5300)
Holder TPDB250-32-5-P (Drill dia. = Ø25 mm)



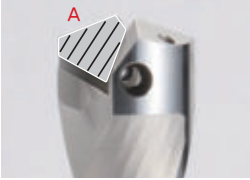
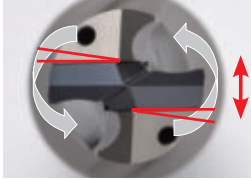
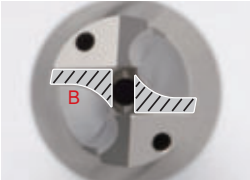



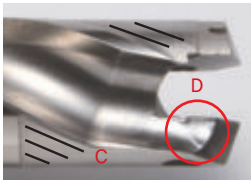
Recommended cutting conditions

Workpiece			Grade	vc (m/min)	Aspect ratio (L/D) = 3D, 5D			
ISO	Workpiece	HB			Feed rate (mm/rev) per drill dia. (mm)			
					Ø10~Ø16.9	Ø17~Ø26.9	Ø27~Ø32.9	
P	Carbon steel	Low carbon steel	80~120	PC5335 PC330P	110 (80~140)	0.15~0.30	0.20~0.35	0.25~0.40
		High carbon steel	180~280	PC5335 PC330P	100 (70~130)	0.15~0.30	0.20~0.35	0.25~0.40
	Alloy steel	Low alloy steel	140~260	PC5300	110 (80~140)	0.18~0.35	0.23~0.38	0.28~0.43
		Low alloy heat treated steel	200~400	PC5300	75 (50~100)	0.18~0.35	0.23~0.38	0.28~0.43
		High alloy steel	50~260	PC5300	70 (50~90)	0.18~0.30	0.20~0.35	0.25~0.40
		High alloy heat treated steel	220~450	PC5300	60 (40~80)	0.18~0.30	0.20~0.35	0.25~0.40
K	Cast iron	Gray cast iron	150~230	PC5300	110 (80~140)	0.18~0.35	0.20~0.40	0.25~0.45
		Ductile cast iron	160~260	PC5300	100 (70~130)	0.18~0.35	0.20~0.40	0.25~0.45

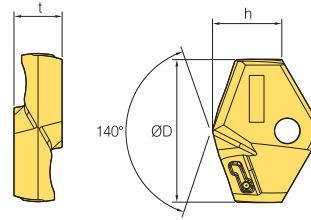
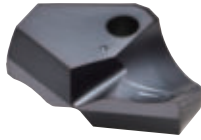
※ In case of 8D, machine in 20-30% lower cutting conditions than the mentioned above, or machine the beginning of hole (1.5D) before drilling.

※ In interrupted machining, reduce the feed to 0.1-0.15 machining around the interrupted part.

Replacement of holders and screws

Worn part	How to check	Description
[Pic.1] 	[Pic.2] Check the gap 	<ul style="list-style-type: none"> In case of drilling for a long time as shown in the [Pic.1] the 'A' part is torn and twisted due to torque As shown in the [Pic.2] check the gap between the insert and the tip seat turning the clamped insert from side to side. If there is a gap between them, replace the used holder to a new one
[Pic.3] 	[Pic.4] Check the moving 	<ul style="list-style-type: none"> The insert could move up or down due to the load on the Z-axis in drilling over an extended period of time which causes wear on the 'B' part as shown the [Pic.3] After clamping an insert, if the insert is moving or there is a gap between the insert and the tip seat as shown in the [Pic.4] replace the used holder to a new one
[Pic.5] 	[Pic.6] Check the moving 	<ul style="list-style-type: none"> After an extended period of use, the screw can be worn as shown in the 'E' part of [Pic.5] which could decrease the clamping force of the insert. When the screw is worn, replace the old screw to a new one among the enclosed extras Spreading the grease on the screw makes it last longer
[Pic.6] <ol style="list-style-type: none"> Check the 'C' and 'D' parts as shown in the [Pic.6] Check whether the chips are getting longer or not. 		<ul style="list-style-type: none"> Winding or jamming of long and tiny chips in drilling causes wear or scratch on the 'C' part as shown in the [Pic.6] due to chattering from machining in improper cutting conditions. In that case, reset the cutting conditions and check the Run-out before machining The excessive wear of the part 'D' as shown in the [Pic.6] relating to chip curling might cause long chips

Available insert



(mm)



Designation	Coated			ØD	h	t
	PC5300	PC5335	PC330P			
TPD 100B	●			10.0	5.5	3.5
105B	●			10.5	5.5	3.5
110B	●	●		11.0	5.8	3.5
115B	●			11.5	5.8	3.5
120B	●	●		12.0	6.3	3.5
125B	●	●		12.5	6.3	3.5
130B	●			13.0	6.5	4.0
135B	●			13.5	6.5	4.0
140B	●	●		14.0	6.8	4.0
145B	●	●		14.5	6.8	4.0
150B	●	●		15.0	7.0	4.0
155B	●	●		15.5	7.0	4.0
160B	●	●		16.0	7.7	5.5
165B	●			16.5	7.7	5.5
170B	●	●		17.0	7.9	5.5
175B	●	●		17.5	7.9	5.5
180B	●	●		18.0	8.1	6.0
185B	●	●		18.5	8.1	6.0
190B	●	●		19.0	8.3	6.0
195B	●			19.5	8.3	6.0
200B	●	●		20.0	9.7	6.5
205B	●			20.5	9.7	6.5
210B	●	●		21.0	9.4	6.5
215B	●			21.5	9.4	6.5
220B	●	●		22.0	9.6	7.0
225B	●			22.5	9.6	7.0
230B	●	●		23.0	9.8	7.0
235B	●			23.5	9.8	7.0
240B	●	●		24.0	10.7	7.5
245B	●			24.5	10.7	7.5
250B	●	●		25.0	10.9	7.5
255B	●			25.5	10.9	7.5
260B	●	●		26.0	11.0	8.5
265B	●			26.5	11.0	8.5
270B	●			27.0	11.8	8.5
275B	●			27.5	11.8	8.5
280B	●			28.0	12.6	9.5
285B	●			28.5	12.6	9.5
290B	●			29.0	12.9	9.5
295B	●			29.5	12.9	9.5
300B	●			30.0	13.0	10.0
305B	●			30.5	13.0	10.0
310B	●			31.0	13.2	10.0
315B	●			31.5	13.2	10.0
320B	●			32.0	13.4	10.0
325B	●			32.5	13.4	10.0

※ We can provide nonstock items with Ø10.00-Ø32.99

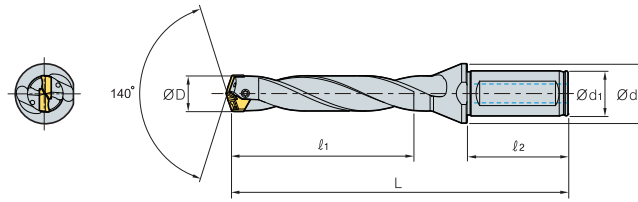
● : Stock Item

Parts

(mm)

Designation	Drill dia. (ØD)	Screw 	Wrench 	Torque (N·m)
TPD 100B~129B	10.0~12.9	FTNB0209-P	TW06P	0.4
130B~149B	13.0~14.9	FTNB02512-P	TW07S	0.8
150B~179B	15.0~17.9	FTNB02514-P	TW07S	0.8
180B~199B	18.0~19.9	FTNB0316-P	TW09S	1.2
200B~239B	20.0~23.9	FTNB0319	TW09S	1.2
240B~259B	24.0~25.9	FTNB03522	TW15S	3.0
260B~279B	26.0~27.9	FTNB03524	TW15S	3.0
280B~299B	28.0~29.9	FTNB0426	TW15S	3.0
300B~329B	30.0~32.9	FTNB0528	TW20-100	4.0

TPDB-P (3D)



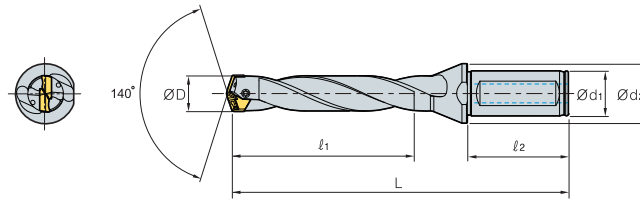
(mm)

Designation	ØD	Ød ₁	Ød ₂	l ₁	l ₂	L	Insert
TPDB 100-16-3-P	10.0~10.4	16	20	30.0	48	96.6	TPD100B~104B
105-16-3-P	10.5~10.9	16	20	31.5	48	97.6	TPD105B~109B
110-16-3-P	11.0~11.4	16	20	33.0	48	99.7	TPD110B~114B
115-16-3-P	11.5~11.9	16	20	34.5	48	100.7	TPD115B~119B
120-16-3-P	12.0~12.4	16	20	36.0	48	104.1	TPD120B~124B
125-16-3-P	12.5~12.9	16	20	37.5	48	106.2	TPD125B~129B
130-16-3-P	13.0~13.4	16	20	39.0	48	109.3	TPD130B~134B
135-16-3-P	13.5~13.9	16	20	40.5	48	111.4	TPD135B~139B
140-16-3-P	14.0~14.4	16	20	42.0	48	113.5	TPD140B~144B
145-16-3-P	14.5~14.9	16	20	43.5	48	116.6	TPD145B~149B
150-20-3-P	15.0~15.4	20	25	45.0	50	120.7	TPD150B~154B
155-20-3-P	15.5~15.9	20	25	46.5	50	122.7	TPD155B~159B
160-20-3-P	16.0~16.4	20	25	48.0	50	124.9	TPD160B~164B
165-20-3-P	16.5~16.9	20	25	49.5	50	126.9	TPD165B~169B
170-20-3-P	17.0~17.4	20	25	51.0	50	130.1	TPD170B~174B
175-20-3-P	17.5~17.9	20	25	52.5	50	132.1	TPD175B~179B
180-25-3-P	18.0~18.4	25	33	54.0	56	140.2	TPD180B~184B
185-25-3-P	18.5~18.9	25	33	55.5	56	142.2	TPD185B~189B
190-25-3-P	19.0~19.4	25	33	57.0	56	145.3	TPD190B~194B
195-25-3-P	19.5~19.9	25	33	58.5	56	147.3	TPD195B~199B
200-25-3-P	20.0~20.4	25	33	60.0	56	149.5	TPD200B~204B
205-25-3-P	20.5~20.9	25	33	61.5	56	151.5	TPD205B~209B
210-25-3-P	21.0~21.4	25	33	63.0	60	154.7	TPD210B~214B
215-25-3-P	21.5~21.9	25	33	64.5	60	156.7	TPD215B~219B
220-25-3-P	22.0~22.4	25	33	66.0	60	158.9	TPD220B~224B
225-25-3-P	22.5~22.9	25	33	67.5	60	160.9	TPD225B~229B
230-25-3-P	23.0~23.4	25	33	69.0	60	164.1	TPD230B~234B
235-25-3-P	23.5~23.9	25	33	70.5	60	166.1	TPD235B~239B
240-32-3-P	24.0~24.4	32	43	72.0	60	172.3	TPD240B~244B
245-32-3-P	24.5~24.9	32	43	73.5	60	174.3	TPD245B~249B
250-32-3-P	25.0~25.4	32	43	75.0	60	177.5	TPD250B~254B
255-32-3-P	25.5~25.9	32	43	76.5	60	179.5	TPD255B~259B
260-32-3-P	26.0~26.9	32	43	78.0	60	181.7	TPD260B~269B
270-32-3-P	27.0~27.9	32	43	81.0	60	186.9	TPD270B~279B
280-32-3-P	28.0~28.9	32	43	84.0	60	191.0	TPD280B~289B
290-32-3-P	29.0~29.9	32	43	87.0	60	196.2	TPD290B~299B
300-32-3-P	30.0~30.9	32	43	90.0	60	199.4	TPD300B~309B
310-32-3-P	31.0~31.9	32	43	93.0	60	204.6	TPD310B~319B
320-32-3-P	32.0~32.9	32	43	96.0	60	206.8	TPD320B~329B

↻ Applicable inserts F57



TPDB-P (5D)

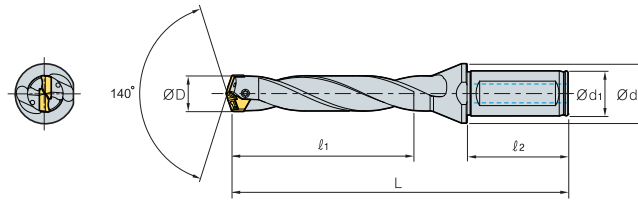


(mm)

Designation	ØD	Ød ₁	Ød ₂	ℓ ₁	ℓ ₂	L	Insert
TPDB 100-16-5-P	10.0~10.4	16	20	50.0	48	116.1	TPD100B~104B
105-16-5-P	10.5~10.9	16	20	52.5	48	118.9	TPD105B~109B
110-16-5-P	11.0~11.4	16	20	55.0	48	121.7	TPD110B~114B
115-16-5-P	11.5~11.9	16	20	57.5	48	124.5	TPD115B~119B
120-16-5-P	12.0~12.4	16	20	60.0	48	128.1	TPD120B~124B
125-16-5-P	12.5~12.9	16	20	62.5	48	131.2	TPD125B~129B
130-16-5-P	13.0~13.4	16	20	65.0	48	135.3	TPD130B~134B
135-16-5-P	13.5~13.9	16	20	67.5	48	138.4	TPD135B~139B
140-16-5-P	14.0~14.4	16	20	70.0	48	141.5	TPD140B~144B
145-16-5-P	14.5~14.9	16	20	72.5	48	145.6	TPD145B~149B
150-20-5-P	15.0~15.4	20	25	75.0	50	150.7	TPD150B~154B
155-20-5-P	15.5~15.9	20	25	77.5	50	153.7	TPD155B~159B
160-20-5-P	16.0~16.4	20	25	80.0	50	156.9	TPD160B~164B
165-20-5-P	16.5~16.9	20	25	82.5	50	159.9	TPD165B~169B
170-20-5-P	17.0~17.4	20	25	85.0	50	164.1	TPD170B~174B
175-20-5-P	17.5~17.9	20	25	87.5	50	167.1	TPD175B~179B
180-25-5-P	18.0~18.4	25	33	90.0	56	176.2	TPD180B~184B
185-25-5-P	18.5~18.9	25	33	92.5	56	179.2	TPD185B~189B
190-25-5-P	19.0~19.4	25	33	95.0	56	183.3	TPD190B~194B
195-25-5-P	19.5~19.9	25	33	97.5	56	186.3	TPD195B~199B
200-25-5-P	20.0~20.4	25	33	100.0	56	189.5	TPD200B~204B
205-25-5-P	20.5~20.9	25	33	102.5	56	192.5	TPD205B~209B
210-25-5-P	21.0~21.4	25	33	105.0	60	196.7	TPD210B~214B
215-25-5-P	21.5~21.9	25	33	107.5	60	199.7	TPD215B~219B
220-25-5-P	22.0~22.4	25	33	110.0	60	202.9	TPD220B~224B
225-25-5-P	22.5~22.9	25	33	112.5	60	205.9	TPD225B~229B
230-25-5-P	23.0~23.4	25	33	115.0	60	210.1	TPD230B~234B
235-25-5-P	23.5~23.9	25	33	117.5	60	213.1	TPD235B~239B
240-32-5-P	24.0~24.4	32	43	120.0	60	220.3	TPD240B~244B
245-32-5-P	24.5~24.9	32	43	122.5	60	223.3	TPD245B~249B
250-32-5-P	25.0~25.4	32	43	125.0	60	227.5	TPD250B~254B
255-32-5-P	25.5~25.9	32	43	127.5	60	230.5	TPD255B~259B
260-32-5-P	26.0~26.9	32	43	130.0	60	233.7	TPD260B~269B
270-32-5-P	27.0~27.9	32	43	135.0	60	240.9	TPD270B~279B
280-32-5-P	28.0~28.9	32	43	140.0	60	247.0	TPD280B~289B
290-32-5-P	29.0~29.9	32	43	145.0	60	254.2	TPD290B~299B
300-32-5-P	30.0~30.9	32	43	150.0	60	259.4	TPD300B~309B
310-32-5-P	31.0~31.9	32	43	155.0	60	266.6	TPD310B~319B
320-32-5-P	32.0~32.9	32	43	160.0	60	270.8	TPD320B~329B

→ Applicable inserts F57

TPDB-P (8D)



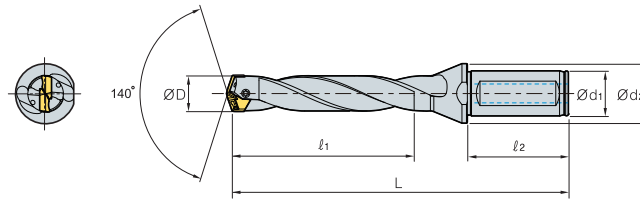
(mm)

Designation	ØD	Ød ₁	Ød ₂	l ₁	l ₂	L	Insert
TPDB 100-16-8-P	10.0~10.4	16	20	80	48	146.1	TPD100B~104B
105-16-8-P	10.5~10.9	16	20	84	48	150.4	TPD105B~109B
110-16-8-P	11.0~11.4	16	20	88	48	154.7	TPD110B~114B
115-16-8-P	11.5~11.9	16	20	92	48	159.0	TPD115B~119B
120-16-8-P	12.0~12.4	16	20	96	48	164.1	TPD120B~124B
125-16-8-P	12.5~12.9	16	20	100	48	168.7	TPD125B~129B
130-16-8-P	13.0~13.4	16	20	104	48	174.3	TPD130B~134B
135-16-8-P	13.5~13.9	16	20	108	48	178.9	TPD135B~139B
140-16-8-P	14.0~14.4	16	20	112	48	183.5	TPD140B~144B
145-16-8-P	14.5~14.9	16	20	116	48	189.1	TPD145B~149B
150-20-8-P	15.0~15.4	20	25	120	50	195.7	TPD150B~154B
155-20-8-P	15.5~15.9	20	25	124	50	200.2	TPD155B~159B
160-20-8-P	16.0~16.4	20	25	128	50	204.9	TPD160B~164B
165-20-8-P	16.5~16.9	20	25	132	50	209.4	TPD165B~169B
170-20-8-P	17.0~17.4	20	25	136	50	215.1	TPD170B~174B
175-20-8-P	17.5~17.9	20	25	140	50	219.6	TPD175B~179B
180-25-8-P	18.0~18.4	25	33	144	56	230.2	TPD180B~184B
185-25-8-P	18.5~18.9	25	33	148	56	234.7	TPD185B~189B
190-25-8-P	19.0~19.4	25	33	152	56	240.3	TPD190B~194B
195-25-8-P	19.5~19.9	25	33	156	56	244.8	TPD195B~199B
200-25-8-P	20.0~20.4	25	33	160	56	249.5	TPD200B~204B
205-25-8-P	20.5~20.9	25	33	164	56	254.0	TPD205B~209B
210-25-8-P	21.0~21.4	25	33	168	60	259.7	TPD210B~214B
215-25-8-P	21.5~21.9	25	33	172	60	264.2	TPD215B~219B
220-25-8-P	22.0~22.4	25	33	176	60	268.9	TPD220B~224B
225-25-8-P	22.5~22.9	25	33	180	60	273.4	TPD225B~229B
230-25-8-P	23.0~23.4	25	33	184	60	279.1	TPD230B~234B
235-25-8-P	23.5~23.9	25	33	188	60	283.6	TPD235B~239B
240-32-8-P	24.0~24.4	32	43	192	60	292.3	TPD240B~244B
245-32-8-P	24.5~24.9	32	43	196	60	296.8	TPD245B~249B
250-32-8-P	25.0~25.4	32	43	200	60	302.5	TPD250B~254B
255-32-8-P	25.5~25.9	32	43	204	60	307.0	TPD255B~259B
260-32-8-P	26.0~26.9	32	43	208	60	311.7	TPD260B~269B
270-32-8-P	27.0~27.9	32	43	216	60	321.9	TPD270B~279B
280-32-8-P	28.0~28.9	32	43	224	60	331.0	TPD280B~289B
290-32-8-P	29.0~29.9	32	43	232	60	341.2	TPD290B~299B
300-32-8-P	30.0~30.9	32	43	240	60	349.4	TPD300B~309B
310-32-8-P	31.0~31.9	32	43	248	60	359.6	TPD310B~319B
320-32-8-P	32.0~32.9	32	43	256	60	366.8	TPD320B~329B

↻ Applicable inserts F57



TPDB-P (10D)

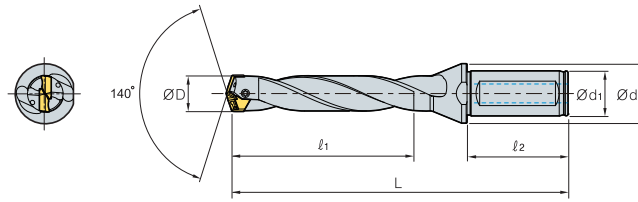


(mm)

Designation	ØD	Ød ₁	Ød ₂	ℓ ₁	ℓ ₂	L	Insert
TPDB 100-16-10-P	10.0~10.4	16	20	100	48	166.6	TPD100B~104B
105-16-10-P	10.5~10.9	16	20	105	48	171.6	TPD105B~109B
110-16-10-P	11.0~11.4	16	20	110	48	176.7	TPD110B~114B
115-16-10-P	11.5~11.9	16	20	115	48	181.7	TPD115B~119B
120-16-10-P	12.0~12.4	16	20	120	48	188.1	TPD120B~124B
125-16-10-P	12.5~12.9	16	20	125	48	193.7	TPD125B~129B
130-16-10-P	13.0~13.4	16	20	130	48	200.3	TPD130B~134B
135-16-10-P	13.5~13.9	16	20	135	48	205.9	TPD135B~139B
140-16-10-P	14.0~14.4	16	20	140	48	211.5	TPD140B~144B
145-16-10-P	14.5~14.9	16	20	145	48	218.1	TPD145B~149B
150-20-10-P	15.0~15.4	20	25	150	50	225.7	TPD150B~154B
155-20-10-P	15.5~15.9	20	25	155	50	231.2	TPD155B~159B
160-20-10-P	16.0~16.4	20	25	160	50	236.9	TPD160B~164B
165-20-10-P	16.5~16.9	20	25	165	50	242.4	TPD165B~169B
170-20-10-P	17.0~17.4	20	25	170	50	249.1	TPD170B~174B
175-20-10-P	17.5~17.9	20	25	175	50	254.6	TPD175B~179B
180-25-10-P	18.0~18.4	25	33	180	56	266.2	TPD180B~184B
185-25-10-P	18.5~18.9	25	33	185	56	271.7	TPD185B~189B
190-25-10-P	19.0~19.4	25	33	190	56	278.3	TPD190B~194B
195-25-10-P	19.5~19.9	25	33	195	56	283.8	TPD195B~199B
200-25-10-P	20.0~20.4	25	33	200	56	289.5	TPD200B~204B
205-25-10-P	20.5~20.9	25	33	205	56	295.0	TPD205B~209B
210-25-10-P	21.0~21.4	25	33	210	60	301.7	TPD210B~214B
215-25-10-P	21.5~21.9	25	33	215	60	307.2	TPD215B~219B
220-25-10-P	22.0~22.4	25	33	220	60	312.9	TPD220B~224B
225-25-10-P	22.5~22.9	25	33	225	60	318.6	TPD225B~229B
230-25-10-P	23.0~23.4	25	33	230	60	325.1	TPD230B~234B
235-25-10-P	23.5~23.9	25	33	235	60	330.6	TPD235B~239B
240-32-10-P	24.0~24.4	32	43	240	60	340.3	TPD240B~244B
245-32-10-P	24.5~24.9	32	43	245	60	345.8	TPD245B~249B
250-32-10-P	25.0~25.4	32	43	250	60	352.5	TPD250B~254B
255-32-10-P	25.5~25.9	32	43	255	60	358.0	TPD255B~259B
260-32-10-P	26.0~26.9	32	43	260	60	363.7	TPD260B~269B
270-32-10-P	27.0~27.9	32	43	270	60	375.9	TPD270B~279B
280-32-10-P	28.0~28.9	32	43	280	60	387.0	TPD280B~289B
290-32-10-P	29.0~29.9	32	43	290	60	399.2	TPD290B~299B
300-32-10-P	30.0~30.9	32	43	300	60	409.4	TPD300B~309B
310-32-10-P	31.0~31.9	32	43	310	60	421.6	TPD310B~319B
320-32-10-P	32.0~32.9	32	43	320	60	430.8	TPD320B~329B

↻ Applicable inserts F57

TPDB-P (12D)



(mm)

Designation	ØD	Ød ₁	Ød ₂	ℓ ₁	ℓ ₂	L	Insert
TPDB 100-16-12-P	10.0~10.4	16	20	120	48	186.6	TPD100B~104B
105-16-12-P	10.5~10.9	16	20	126	48	192.6	TPD105B~109B
110-16-12-P	11.0~11.4	16	20	132	48	198.7	TPD110B~114B
115-16-12-P	11.5~11.9	16	20	138	48	204.7	TPD115B~119B
120-16-12-P	12.0~12.4	16	20	144	48	212.1	TPD120B~124B
125-16-12-P	12.5~12.9	16	20	150	48	218.7	TPD125B~129B
130-16-12-P	13.0~13.4	16	20	156	48	226.3	TPD130B~134B
135-16-12-P	13.5~13.9	16	20	162	48	232.9	TPD135B~139B
140-16-12-P	14.0~14.4	16	20	168	48	239.5	TPD140B~144B
145-16-12-P	14.5~14.9	16	20	174	48	247.1	TPD145B~149B
150-20-12-P	15.0~15.4	20	25	180	50	255.7	TPD150B~154B
155-20-12-P	15.5~15.9	20	25	186	50	262.2	TPD155B~159B
160-20-12-P	16.0~16.4	20	25	192	50	268.9	TPD160B~164B
165-20-12-P	16.5~16.9	20	25	198	50	275.4	TPD165B~169B
170-20-12-P	17.0~17.4	20	25	204	50	283.1	TPD170B~174B
175-20-12-P	17.5~17.9	20	25	210	50	289.6	TPD175B~179B
180-25-12-P	18.0~18.4	25	33	216	56	302.2	TPD180B~184B
185-25-12-P	18.5~18.9	25	33	222	56	308.7	TPD185B~189B
190-25-12-P	19.0~19.4	25	33	228	56	316.3	TPD190B~194B
195-25-12-P	19.5~19.9	25	33	234	56	322.8	TPD195B~199B
200-25-12-P	20.0~20.4	25	33	240	56	329.5	TPD200B~204B
205-25-12-P	20.5~20.9	25	33	246	56	336.0	TPD205B~209B
210-25-12-P	21.0~21.4	25	33	252	60	343.7	TPD210B~214B
215-25-12-P	21.5~21.9	25	33	258	60	350.2	TPD215B~219B
220-25-12-P	22.0~22.4	25	33	264	60	356.9	TPD220B~224B
225-25-12-P	22.5~22.9	25	33	270	60	363.6	TPD225B~229B
230-25-12-P	23.0~23.4	25	33	276	60	371.1	TPD230B~234B
235-25-12-P	23.5~23.9	25	33	282	60	377.6	TPD235B~239B
240-32-12-P	24.0~24.4	32	43	288	60	388.3	TPD240B~244B
245-32-12-P	24.5~24.9	32	43	294	60	394.8	TPD245B~249B
250-32-12-P	25.0~25.4	32	43	300	60	402.5	TPD250B~254B
255-32-12-P	25.5~25.9	32	43	306	60	409.0	TPD255B~259B
260-32-12-P	26.0~26.9	32	43	312	60	415.7	TPD260B~269B
270-32-12-P	27.0~27.9	32	43	324	60	429.9	TPD270B~279B
280-32-12-P	28.0~28.9	32	43	336	60	443.0	TPD280B~289B
290-32-12-P	29.0~29.9	32	43	348	60	457.2	TPD290B~299B
300-32-12-P	30.0~30.9	32	43	360	60	469.4	TPD300B~309B
310-32-12-P	31.0~31.9	32	43	372	60	483.6	TPD310B~319B
320-32-12-P	32.0~32.9	32	43	384	60	494.8	TPD320B~329B

↻ Applicable inserts F57



Cutting edge with 180° point angle - Flat bottom machining

TPDB-F *new*

- High precision clamping system - High precision clamping due to high precise grinding and auto-centering
- Screw on clamping system - Easy to replace insert
- Low cutting load cutting edge - Low cutting load and excellent chip control
- High durability holder - Improved wear resistance and durability with special surface treatment implementation
- Holder with good chip evacuation - Good chip evacuation and reduced cutting load with high helix angle

Code system

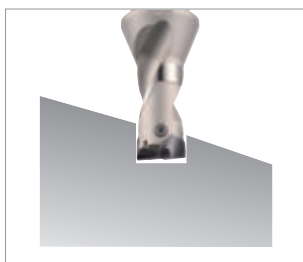
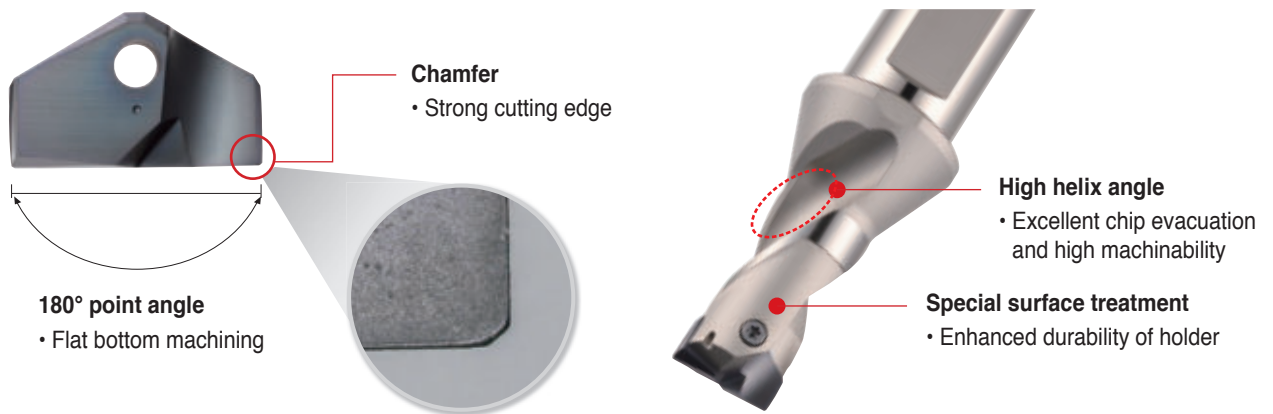
• Insert



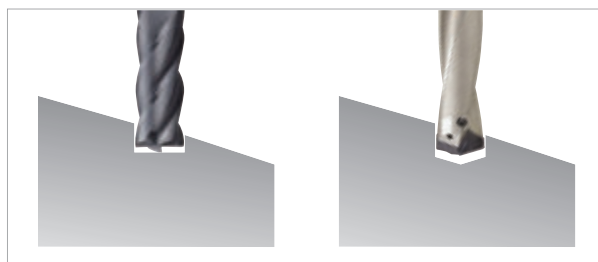
• Holder



Features



[Endmill + Drill]

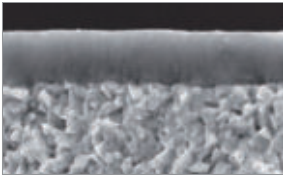


[Endmill]

[Drill]

F Technical Information for TPDB-F

Grade selection



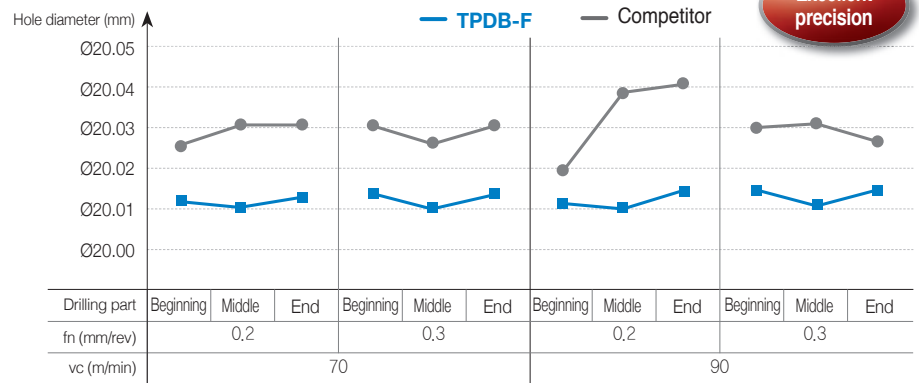
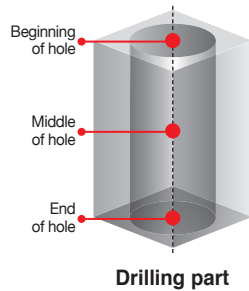
PC5400

- PVD coating technology with high lubrication, built up edge resistance and chipping resistance
- Excellent chipping resistance due to high toughness coating with high adhesive strength
- Enhanced fracture resistance and stable machinability due to ultra-fine substrate with high toughness substrate

Performance evaluation

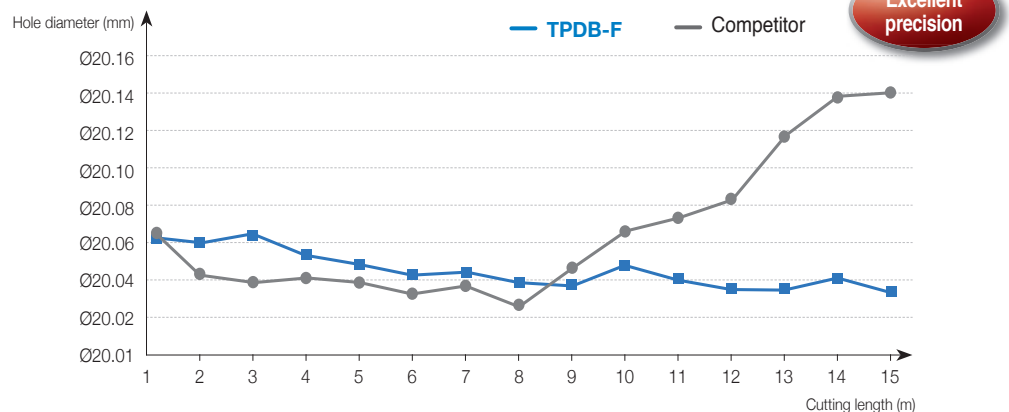
Precision

- **Workpiece** Alloy steel (SCM440, Hrc22)
- **Cutting conditions** vc (m/min) = 70/90, fn (mm/rev) = 0.2/0.3, ap (mm) = 30, wet (20 bar)
- **Tools** Insert TPD200B-F (PC5400) Holder TPDB200-25-1.5-F (Drill dia. = Ø20 mm)



Cutting edge with low cutting load enhances high precision

- **Workpiece** Alloy steel (SCM440, Hrc22), Angled surface 15°
- **Cutting conditions** vc (m/min) = 70, fn (mm/rev) = 0.21, ap (mm) = 20, wet (20 bar)
- **Tools** Insert TPD200B-F (PC5400) Holder TPDB200-25-1.5-F (Drill dia. = Ø20 mm)


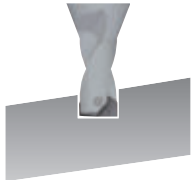
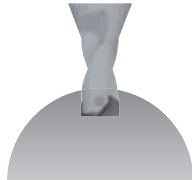




Cutting edge with low cutting load enhances high precision



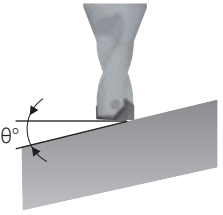
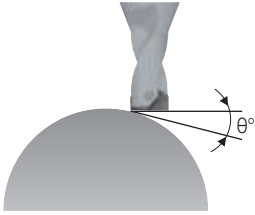
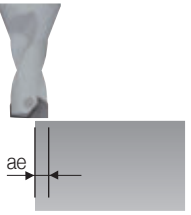
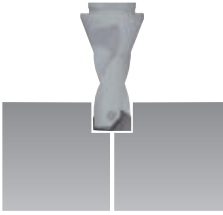
Recommended cutting condition (TPDB-F)

Workpiece			Grade	vc (m/min)	Aspect ratio (L/D) = 1.5D	
ISO	Workpiece	HB			Feed rate (mm/rev) per drill dia. (mm)	
					Ø14.0~Ø21.9	Ø22.0~Ø30.9
P	Carbon steel	Low carbon steel (SM10C, SM20C etc)	PC5400	80 (60~100)	0.2~0.3	0.22~0.32
		High carbon steel (SM45C, SM50C etc)		70 (50~90)	0.2~0.3	0.22~0.32
	Alloy steel	Low alloy steel (SCM420, SCM440 etc)		70 (50~90)	0.2~0.3	0.22~0.32
		High alloy steel (SCM435, SCM445 etc)		60 (40~80)	0.2~0.3	0.22~0.32

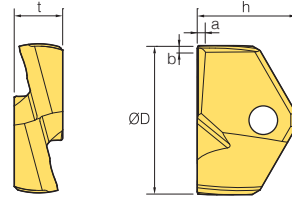
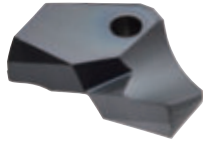
Machining	Flat surface drilling	Angled surface drilling	Curved surface drilling	Plunging	Boring
Pic.					
1.5D	○	○	○	○	○

※ Please refer to the precaution in drilling in case of angled surface, curved surface drilling, plunging and boring

Precaution in drilling

Angled surface drilling	Curved surface drilling	Plunging	Boring
			
<ul style="list-style-type: none"> Reduce the feed (fn) to 30% than general cutting conditions at the beginning and the end of angled surface (In case, θ is over 30°, reduce it to 50%) 	<ul style="list-style-type: none"> Reduce the feed (fn) to 30% than general cutting conditions at the beginning of curved surface (In case, θ is over 30°, reduce it to 50%) 	<ul style="list-style-type: none"> Reduce the depth of cut (ae) to shorter than 1/2 of drill diameter In case, the depth of cut is longer than drill diameter, plunge with divided depth of cut 	<ul style="list-style-type: none"> Reduce the feed (fn) to 30% than general cutting conditions at the beginning of boring Start with 2 mm stepping before boring to prevent long chip

Available insert



(mm)

Designation	Coated	ØD	h	t	a	b
	PC5400					
TPD 140B-F		14.0	8.75	4.0	0.065	0.055
145B-F		14.5	8.75	4.0	0.065	0.055
150B-F		15.0	9.25	4.0	0.065	0.055
155B-F		15.5	9.25	4.0	0.065	0.055
160B-F		16.0	10.25	5.5	0.065	0.055
165B-F		16.5	10.25	5.5	0.065	0.055
170B-F		17.0	10.75	5.5	0.065	0.055
175B-F		17.5	10.75	5.5	0.065	0.055
180B-F		18.0	11.75	6.0	0.065	0.055
185B-F		18.5	11.75	6.0	0.065	0.055
190B-F		19.0	12.25	6.0	0.065	0.055
195B-F		19.5	12.25	6.0	0.065	0.055
200B-F		20.0	12.75	6.5	0.065	0.055
205B-F		20.5	12.75	6.5	0.065	0.055
210B-F		21.0	13.25	6.5	0.065	0.055
215B-F		21.5	13.25	6.5	0.065	0.055
220B-F		22.0	13.75	7.0	0.065	0.055
225B-F		22.5	13.75	7.0	0.065	0.055
230B-F		23.0	14.25	7.0	0.065	0.055
235B-F		23.5	14.25	7.0	0.065	0.055
240B-F		24.0	14.75	7.5	0.065	0.055
245B-F		24.5	14.75	7.5	0.065	0.055
250B-F		25.0	15.25	7.5	0.065	0.055
255B-F		25.5	15.25	7.5	0.065	0.055
260B-F		26.0	15.75	8.5	0.065	0.055
265B-F		26.5	15.75	8.5	0.065	0.055
270B-F		27.0	16.75	8.5	0.065	0.055
275B-F		27.5	16.75	8.5	0.065	0.055
280B-F		28.0	17.75	9.5	0.065	0.055
285B-F		28.5	17.75	9.5	0.065	0.055
290B-F		29.0	18.25	9.5	0.065	0.055
295B-F		29.5	18.25	9.5	0.065	0.055
300B-F		30.0	18.75	10.0	0.065	0.055
305B-F		30.5	18.75	10.0	0.065	0.055

※ We can provide nonstock items with Ø14.00-Ø30.99

Parts

(mm)

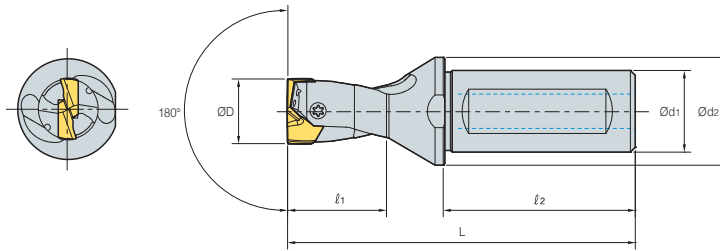
Designation	Drill dia. (ØD)	Screw	Wrench	Torque (N·m)
TPD 140B-F~149B-F	14.0~14.9	FTNB02512-P	TW07S	0.8
150B-F~179B-F	15.0~17.9	FTNB02514-P	TW07S	0.8
180B-F~199B-F	18.0~19.9	FTNB0316-P	TW09S	1.2
200B-F~239B-F	20.0~23.9	FTNB0319	TW09S	1.2
240B-F~259B-F	24.0~25.9	FTNB03522	TW15S	3.0
260B-F~279B-F	26.0~27.9	FTNB03524	TW15S	3.0
280B-F~299B-F	28.0~29.9	FTNB0426	TW15S	3.0
300B-F~309B-F	30.0~30.9	FTNB0528	TW20-100	4.0



F

Drills

TPDB-F (1.5D)



(mm)

Designation	ØD	Ød ₁	Ød ₂	l ₁	l ₂	L	Insert
TPDB 140-16-1.5-F	14.0~14.4	16	20	28	48	86.0	TPD140B-F~TPD144B-F
145-16-1.5-F	14.5~14.9	16	20	29	48	87.0	TPD145B-F~TPD149B-F
150-20-1.5-F	15.0~15.4	20	25	30	50	93.0	TPD150B-F~TPD154B-F
155-20-1.5-F	15.5~15.9	20	25	31	50	94.0	TPD155B-F~TPD159B-F
160-20-1.5-F	16.0~16.4	20	25	32	50	95.0	TPD160B-F~TPD164B-F
165-20-1.5-F	16.5~16.9	20	25	33	50	96.0	TPD165B-F~TPD169B-F
170-20-1.5-F	17.0~17.4	20	25	34	50	97.0	TPD170B-F~TPD174B-F
175-20-1.5-F	17.5~17.9	20	25	35	50	98.0	TPD175B-F~TPD179B-F
180-20-1.5-F	18.0~18.4	20	25	36	50	99.0	TPD180B-F~TPD184B-F
185-20-1.5-F	18.5~18.9	20	25	37	50	100.0	TPD185B-F~TPD189B-F
190-25-1.5-F	19.0~19.4	25	33	38	56	101.0	TPD190B-F~TPD194B-F
195-25-1.5-F	19.5~19.9	25	33	39	56	102.0	TPD195B-F~TPD199B-F
200-25-1.5-F	20.0~20.4	25	33	40	56	116.0	TPD200B-F~TPD204B-F
205-25-1.5-F	20.5~20.9	25	33	41	56	117.0	TPD205B-F~TPD209B-F
210-25-1.5-F	21.0~21.4	25	33	42	56	118.0	TPD210B-F~TPD214B-F
215-25-1.5-F	21.5~21.9	25	33	43	56	119.0	TPD215B-F~TPD219B-F
220-25-1.5-F	22.0~22.4	25	33	44	56	120.0	TPD220B-F~TPD224B-F
225-25-1.5-F	22.5~22.9	25	33	45	56	121.0	TPD225B-F~TPD229B-F
230-25-1.5-F	23.0~23.4	25	33	46	56	122.0	TPD230B-F~TPD234B-F
235-25-1.5-F	23.5~23.9	25	33	47	56	123.0	TPD235B-F~TPD239B-F
240-32-1.5-F	24.0~24.4	32	43	48	60	128.5	TPD240B-F~TPD244B-F
245-32-1.5-F	24.5~24.9	32	43	49	60	129.5	TPD245B-F~TPD249B-F
250-32-1.5-F	25.0~25.4	32	43	50	60	130.5	TPD250B-F~TPD254B-F
255-32-1.5-F	25.5~25.9	32	43	51	60	131.5	TPD255B-F~TPD259B-F
260-32-1.5-F	26.0~26.4	32	43	52	60	132.5	TPD260B-F~TPD264B-F
265-32-1.5-F	26.5~26.9	32	43	53	60	133.5	TPD265B-F~TPD269B-F
270-32-1.5-F	27.0~27.4	32	43	54	60	134.5	TPD270B-F~TPD274B-F
275-32-1.5-F	27.5~27.9	32	43	55	60	135.5	TPD275B-F~TPD279B-F
280-32-1.5-F	28.0~28.4	32	43	56	60	136.5	TPD280B-F~TPD284B-F
285-32-1.5-F	28.5~28.9	32	43	57	60	137.5	TPD285B-F~TPD289B-F
290-32-1.5-F	29.0~29.4	32	43	58	60	138.5	TPD290B-F~TPD294B-F
295-32-1.5-F	29.5~29.9	32	43	59	60	139.5	TPD295B-F~TPD299B-F
300-32-1.5-F	30.0~30.4	32	43	60	60	140.5	TPD300B-F~TPD304B-F
305-32-1.5-F	30.5~30.9	32	43	61	60	141.5	TPD305B-F~TPD309B-F

↻ Applicable inserts F66

F Technical Information for TPDB-H

The exclusive top solid indexable drill for steel-frame structure, H-Beam

TPDB-H new

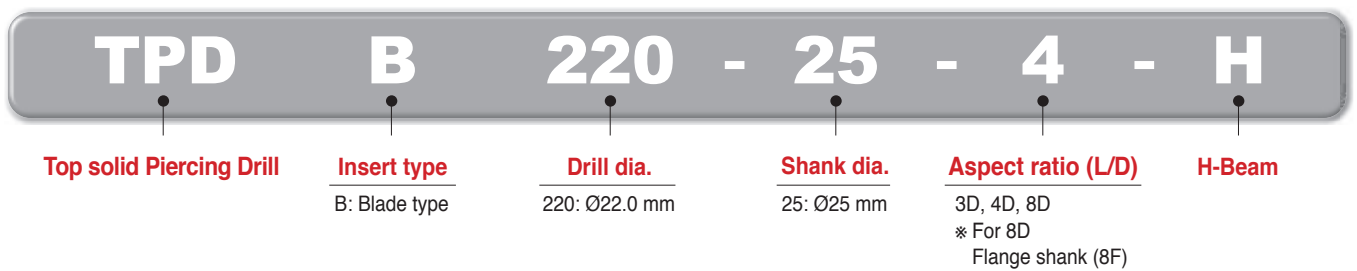
- High precision clamping system - High precision clamping due highly precise grinding and auto-centering
- Screw on clamping system - Easy to replace insert
- Edge design with excellent centering - Low cutting load and good chip control
- High durability holder - Improved wear resistance and durability with special surface treatment implementation
- Holder with good chip evacuation - Good chip evacuation and reduced cutting load with high helix angle
- Optimally designed oil hole - Long tool life

🔗 Code system

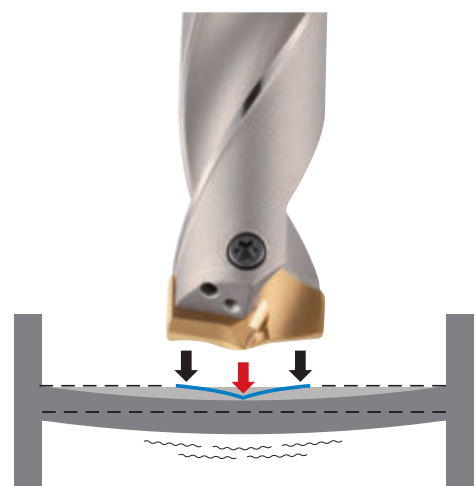
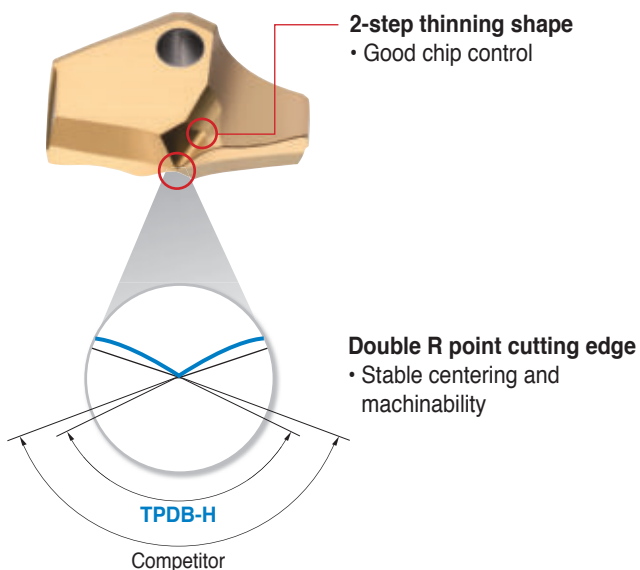
• Insert



• Holder



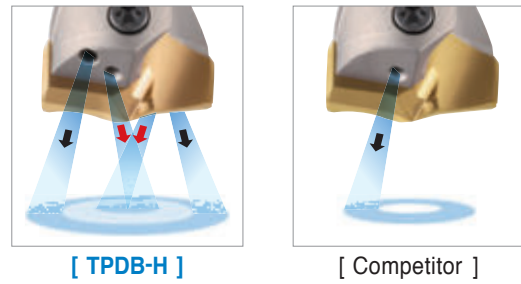
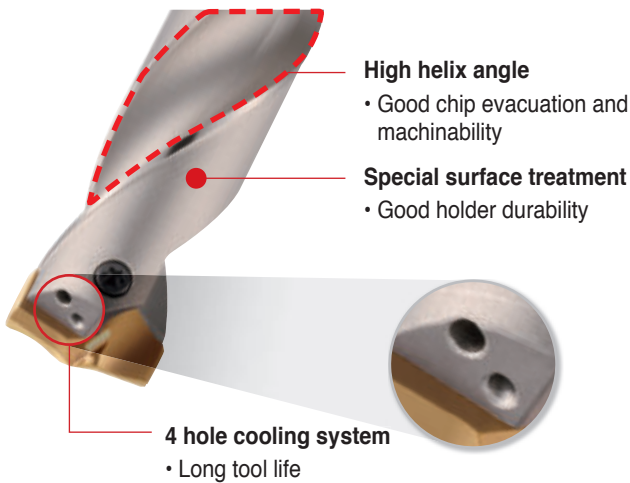
🔗 Features of insert



↓ Applied Double R point edge design is optimized for excellent centering and stable machinability

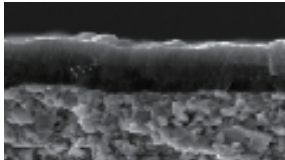
↓ Machinability and productivity are improved by minimizing both workpiece's bending and chipping at edge corner section

Features of holder



Concentrated coolant injection on delicate cutting edge increases tool life

Grade selection



PC340Q new

- Application of high hardness lubricative PVD coating technology with excellent resistance on wear, welding, and chipping
- The special surface treatment improves chip evacuation and reduces wear on the rake surface and relief face
- High hardness ultra-fine substrate ensures high rigidity of cutting edge and good chipping resistance

Performance evaluation

Chip control

- **Workpiece** Carbon steel (SS275, SM355A)
- **Cutting conditions** vc (m/min) = 80, fn (mm/rev) = 0.2
ap (mm) = 30, wet
- **Tools** **Insert** TPD270B-H (PC340Q)
Holder TPDB270-32-4-H
(Drill dia. = Ø27 mm)



SS275



SM355A



Wear resistance

- **Workpiece** Carbon steel (SS275)
- **Cutting conditions** vc (m/min) = 65, fn (mm/rev) = 0.25
ap (mm) = 30, wet
- **Tools** **Insert** TPD220B-H (PC340Q)
Holder TPDB220-25-4-H
(Drill dia. = Ø22 mm)
- **Workpiece** Carbon steel (SM355A)
- **Cutting conditions** vc (m/min) = 70, fn (mm/rev) = 0.25
ap (mm) = 30, wet
- **Tools** **Insert** TPD270B-H (PC340Q)
Holder TPDB270-32-4-H
(Drill dia. = Ø27 mm)

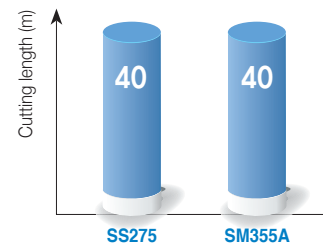


SS275



SM355A

Test result



• Normal wear and still usable

Workpiece and recommended cutting conditions

Workpiece			Grade	vc (m/min)	Aspect ratio (L/D) = 3D, 4D		
ISO	Workpiece	Workpiece materials			Feed rate (mm/rev) per drill dia. (mm)		
					Ø14.0~Ø21.0	Ø22.0~Ø30.0	
P	Carbon steel	H-Beam	SS275 (SS400*) SM355 (SM490*) SHN355 (SHN490*)	PC340Q	65 (60~75)	0.2~0.25	0.2~0.3
		Angle					
		Plate					
		Plate (Stacked)			60 (55~65)	0.15~0.25	0.15~0.25

*: old symbol

Precaution in drilling

Angled surface drilling



- The approach angle between drill and the workpiece at the beginning and the end should be less than 6°
- Reduce the feed (fn) to 30-50% than general cutting conditions at the beginning and the end of angled surface

Stacked plates drilling



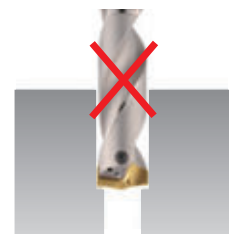
- Gap between the plates could make wrong chip evacuation causing fracture of the drill
- Place stacked plates without any gap between each

Plunging



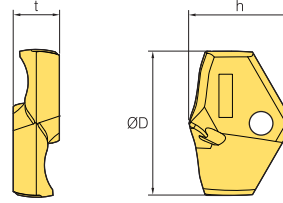
- Irregular cutting resistance in plunging could cause fracture and deformation of the drill

Boring



- Boring is not recommended due to wear and chipping in the corner of the insert

 Available insert



(mm)



Designation	Coated	ØD	h	t
	PC5300			
TPD	140B-H	14.0	10.0	4.0
	145B-H	14.5	10.0	4.0
	150B-H	15.0	10.5	4.0
	155B-H	15.5	10.5	4.0
	160B-H	16.0	11.5	5.5
	165B-H	16.5	11.5	5.5
	170B-H	17.0	12.0	5.5
	175B-H	17.5	12.0	5.5
	180B-H	18.0	13.0	6.0
	185B-H	18.5	13.0	6.0
	190B-H	19.0	13.5	6.0
	195B-H	19.5	13.5	6.0
	200B-H	20.0	14.5	6.5
	205B-H	20.5	14.5	6.5
	210B-H	21.0	15.0	6.5
	215B-H	21.5	15.0	6.5
	220B-H	22.0	15.5	7.0
	225B-H	22.5	15.5	7.0
	230B-H	23.0	16.0	7.0
	235B-H	23.5	16.0	7.0
	240B-H	24.0	16.5	7.5
	245B-H	24.5	16.5	7.5
	250B-H	25.0	17.0	7.5
	255B-H	25.5	17.0	7.5
	260B-H	26.0	17.5	8.5
	265B-H	26.5	17.5	8.5
	270B-H	27.0	18.5	8.5
	275B-H	27.5	18.5	8.5
	280B-H	28.0	19.5	9.5
	285B-H	28.5	19.5	9.5
	290B-H	29.0	20.0	9.5
	295B-H	29.5	20.0	9.5
300B-H	30.0	20.5	10.0	
305B-H	30.5	20.5	10.0	

※ We can provide nonstock items with Ø14.00-Ø30.99

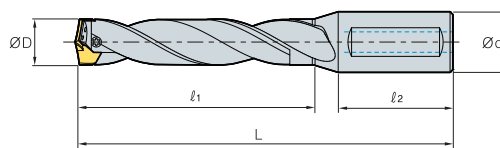
● : Stock Item

 Parts

(mm)

Designation	Drill dia. (ØD)	Screw 	Wrench 	Torque (N·m)	
TPD	140B-H~149B-H	14.0~14.9	FTNB02512-P	TW07S	0.8
	150B-H~179B-H	15.0~17.9	FTNB02514-P	TW07S	0.8
	180B-H~199B-H	18.0~19.9	FTNB0316-P	TW09S	1.2
	200B-H~239B-H	20.0~23.9	FTNB0319	TW09S	1.2
	240B-H~259B-H	24.0~25.9	FTNB03522	TW15S	3.0
	260B-H~279B-H	26.0~27.9	FTNB03524	TW15S	3.0
	280B-H~299B-H	28.0~29.9	FTNB0426	TW15S	3.0
	300B-H~309B-H	30.0~30.9	FTNB0528	TW20-100	4.0

TPDB-H (3D)



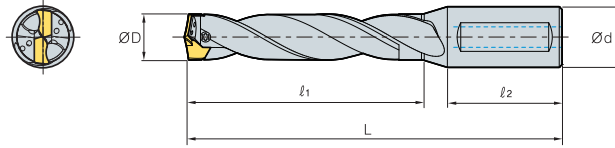
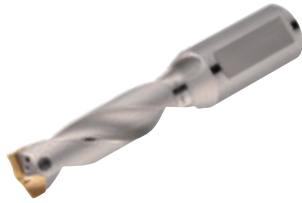
(mm)

Designation	ØD	Ød	ℓ ₁	ℓ ₂	L	Insert	
TPDB	140-16-3-H	14.0~14.4	16	42	48	98.8	TPD140B-144B-H
	145-16-3-H	14.5~14.9	16	43.5	48	100.8	TPD145B-149B-H
	150-20-3-H	15.0~15.4	20	45	50	104.4	TPD150B-154B-H
	155-20-3-H	15.5~15.9	20	46.5	50	106.4	TPD155B-159B-H
	160-20-3-H	16.0~16.4	20	48	50	108.0	TPD160B-164B-H
	165-20-3-H	16.5~16.9	20	49.5	50	110.0	TPD165B-169B-H
	170-20-3-H	17.0~17.4	20	51	50	111.5	TPD170B-174B-H
	175-20-3-H	17.5~17.9	20	52.5	50	113.5	TPD175B-179B-H
	180-20-3-H	18.0~18.4	20	54	50	115.1	TPD180B-184B-H
	185-20-3-H	18.5~18.9	20	55.5	50	117.1	TPD185B-189B-H
	190-20-3-H	19.0~19.4	20	57	50	118.7	TPD190B-194B-H
	195-20-3-H	19.5~19.9	20	58.5	50	120.7	TPD195B-199B-H
	200-25-3-H	20.0~20.4	25	60	56	128.3	TPD200B-204B-H
	205-25-3-H	20.5~20.9	25	61.5	56	130.3	TPD205B-209B-H
	210-25-3-H	21.0~21.4	25	63	56	131.9	TPD210B-214B-H
	215-25-3-H	21.5~21.9	25	64.5	56	133.9	TPD215B-219B-H
	220-25-3-H	22.0~22.4	25	66	56	135.5	TPD220B-224B-H
	225-25-3-H	22.5~22.9	25	67.5	56	137.5	TPD225B-229B-H
	230-25-3-H	23.0~23.4	25	69	56	139.1	TPD230B-234B-H
	235-25-3-H	23.5~23.9	25	70.5	56	141.1	TPD235B-239B-H
	240-32-3-H	24.0~24.4	32	72	60	146.8	TPD240B-244B-H
	245-32-3-H	24.5~24.9	32	73.5	60	148.8	TPD245B-249B-H
	250-32-3-H	25.0~25.4	32	75	60	150.3	TPD250B-254B-H
	255-32-3-H	25.5~25.9	32	76.5	60	152.3	TPD255B-259B-H
	260-32-3-H	26.0~26.4	32	78	60	153.8	TPD260B-264B-H
	265-32-3-H	26.5~26.9	32	79.5	60	155.8	TPD265B-269B-H
	270-32-3-H	27.0~27.4	32	81	60	157.5	TPD270B-274B-H
	275-32-3-H	27.5~27.9	32	82.5	60	159.5	TPD275B-279B-H
	280-32-3-H	28.0~28.4	32	84	60	161.0	TPD280B-284B-H
	285-32-3-H	28.5~28.9	32	85.5	60	163.0	TPD285B-289B-H
290-32-3-H	29.0~29.4	32	87	60	164.6	TPD290B-294B-H	
295-32-3-H	29.5~29.9	32	88.5	60	166.6	TPD295B-299B-H	
300-32-3-H	30.0~30.9	32	90	60	168.2	TPD300B-309B-H	

➔ Applicable inserts F71



TPDB-H (4D)

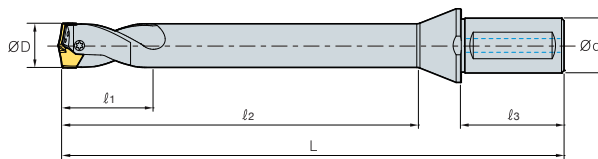


(mm)

Designation	ØD	Ød	l ₁	l ₂	L	Insert	
TPDB	140-16-4-H	14.0~14.4	16	56	48	112.8	TPD140B-144B-H
	145-16-4-H	14.5~14.9	16	58	48	115.3	TPD145B-149B-H
	150-20-4-H	15.0~15.4	20	60	50	119.4	TPD150B-154B-H
	155-20-4-H	15.5~15.9	20	62	50	121.9	TPD155B-159B-H
	160-20-4-H	16.0~16.4	20	64	50	124.0	TPD160B-164B-H
	165-20-4-H	16.5~16.9	20	66	50	126.5	TPD165B-169B-H
	170-20-4-H	17.0~17.4	20	68	50	128.5	TPD170B-174B-H
	175-20-4-H	17.5~17.9	20	70	50	131.0	TPD175B-179B-H
	180-20-4-H	18.0~18.4	20	72	50	133.1	TPD180B-184B-H
	185-20-4-H	18.5~18.9	20	74	50	135.6	TPD185B-189B-H
	190-20-4-H	19.0~19.4	20	76	50	137.7	TPD190B-194B-H
	195-20-4-H	19.5~19.9	20	78	50	140.2	TPD195B-199B-H
	200-25-4-H	20.0~20.4	25	80	56	148.3	TPD200B-204B-H
	205-25-4-H	20.5~20.9	25	82	56	150.8	TPD205B-209B-H
	210-25-4-H	21.0~21.4	25	84	56	152.9	TPD210B-214B-H
	215-25-4-H	21.5~21.9	25	86	56	155.4	TPD215B-219B-H
	220-25-4-H	22.0~22.4	25	88	56	157.5	TPD220B-224B-H
	225-25-4-H	22.5~22.9	25	90	56	160.0	TPD225B-229B-H
	230-25-4-H	23.0~23.4	25	92	56	162.1	TPD230B-234B-H
	235-25-4-H	23.5~23.9	25	94	56	164.6	TPD235B-239B-H
	240-32-4-H	24.0~24.4	32	96	60	170.8	TPD240B-244B-H
	245-32-4-H	24.5~24.9	32	98	60	173.3	TPD245B-249B-H
	250-32-4-H	25.0~25.4	32	100	60	175.3	TPD250B-254B-H
	255-32-4-H	25.5~25.9	32	102	60	177.8	TPD255B-259B-H
	260-32-4-H	26.0~26.4	32	104	60	179.8	TPD260B-264B-H
	265-32-4-H	26.5~26.9	32	106	60	182.3	TPD265B-269B-H
	270-32-4-H	27.0~27.4	32	108	60	184.5	TPD270B-274B-H
	275-32-4-H	27.5~27.9	32	110	60	187.0	TPD275B-279B-H
	280-32-4-H	28.0~28.4	32	112	60	189.0	TPD280B-284B-H
	285-32-4-H	28.5~28.9	32	114	60	191.5	TPD285B-289B-H
290-32-4-H	29.0~29.4	32	116	60	193.6	TPD290B-294B-H	
295-32-4-H	29.5~29.9	32	118	60	196.1	TPD295B-299B-H	
300-32-4-H	30.0~30.9	32	120	60	198.2	TPD300B-309B-H	

↻ Applicable inserts F71

TPDB-H (8D)



(mm)

Designation	ØD	Ød	ℓ ₁	ℓ ₂	ℓ ₃	L	Insert	
TPDB	140-16-8F-H	14.0~14.4	16	50	112	48	176.3	TPD140B-144B-H
	145-16-8F-H	14.5~14.9	16	50	116	48	180.3	TPD145B-149B-H
	150-20-8F-H	15.0~15.4	20	50	120	50	187.4	TPD150B-154B-H
	155-20-8F-H	15.5~15.9	20	50	124	50	191.4	TPD155B-159B-H
	160-20-8F-H	16.0~16.4	20	50	128	50	196.5	TPD160B-164B-H
	165-20-8F-H	16.5~16.9	20	50	132	50	200.5	TPD165B-169B-H
	170-20-8F-H	17.0~17.4	20	50	136	50	205.5	TPD170B-174B-H
	175-20-8F-H	17.5~17.9	20	50	140	50	209.5	TPD175B-179B-H
	180-20-8F-H	18.0~18.4	20	50	144	50	215.6	TPD180B-184B-H
	185-20-8F-H	18.5~18.9	20	50	148	50	219.6	TPD185B-189B-H
	190-20-8F-H	19.0~19.4	20	50	152	50	223.7	TPD190B-194B-H
	195-20-8F-H	19.5~19.9	20	50	156	50	227.7	TPD195B-199B-H
	200-25-8F-H	20.0~20.4	25	50	160	56	237.8	TPD200B-204B-H
	205-25-8F-H	20.5~20.9	25	50	164	56	241.8	TPD205B-209B-H
	210-25-8F-H	21.0~21.4	25	50	168	56	245.9	TPD210B-214B-H
	215-25-8F-H	21.5~21.9	25	50	172	56	249.9	TPD215B-219B-H
	220-25-8F-H	22.0~22.4	25	50	176	56	254.0	TPD220B-224B-H
	225-25-8F-H	22.5~22.9	25	50	180	56	263.0	TPD225B-229B-H
	230-25-8F-H	23.0~23.4	25	50	184	56	267.1	TPD230B-234B-H
	235-25-8F-H	23.5~23.9	25	50	188	56	271.1	TPD235B-239B-H
	240-32-8F-H	24.0~24.4	32	50	192	60	279.3	TPD240B-244B-H
	245-32-8F-H	24.5~24.9	32	50	196	60	283.3	TPD245B-249B-H
	250-32-8F-H	25.0~25.4	32	50	200	60	287.3	TPD250B-254B-H
	255-32-8F-H	25.5~25.9	32	50	204	60	291.3	TPD255B-259B-H
	260-32-8F-H	26.0~26.4	32	50	208	60	295.3	TPD260B-264B-H
	265-32-8F-H	26.5~26.9	32	50	212	60	299.3	TPD265B-269B-H
	270-32-8F-H	27.0~27.4	32	50	216	60	303.5	TPD270B-274B-H
	275-32-8F-H	27.5~27.9	32	50	220	60	307.5	TPD275B-279B-H
	280-32-8F-H	28.0~28.4	32	50	224	60	313.5	TPD280B-284B-H
	285-32-8F-H	28.5~28.9	32	50	228	60	317.5	TPD285B-289B-H
290-32-8F-H	29.0~29.4	32	50	232	60	322.6	TPD290B-294B-H	
295-32-8F-H	29.5~29.9	32	50	236	60	326.6	TPD295B-299B-H	
300-32-8F-H	30.0~30.9	32	50	240	60	330.7	TPD300B-309B-H	

↻ Applicable inserts F71

※ The maximum length of flute could be ℓ₂



Convenient and quickly adjustable drill height

WPDC

Indexable drill clamped with center drill

Code system

• Holder

WPDC	410	40	8
Type	Drill dia.	Shank dia.	Aspect ratio (L/D)
WPDC: Using W-type I/S center drill NPDC: Using N-type I/S center drill	410: Ø41.0 mm 6570: Ø65~70 mm	32: Ø32 mm 40: Ø40 mm	5: 5D 6.5: 6.5D 8: 8D

• Cartridge

CWP	4145	C
Type	Drill dia.	Classification
CWP: Cartridge-WPDC	4145: Ø41~45 mm 450: Ø45.0 mm	C: Central P: Peripheral

• Center drill

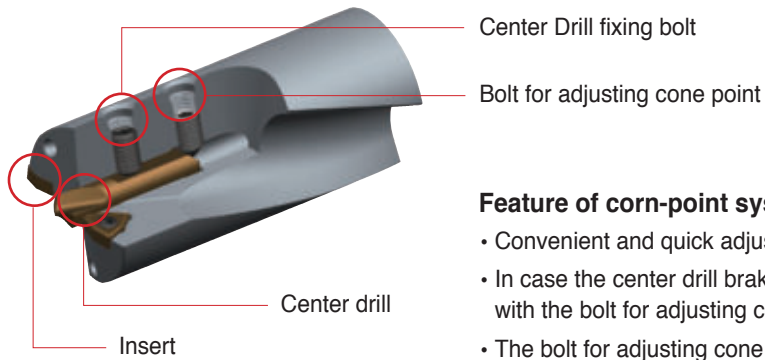
CD	H	1035
Type	Coolant	Diameter × length of tool
Center Drill	H: Coolant Unmarked: None	0630: Ø6 X 30mm 0835: Ø8 X 35 mm 1035: Ø10 X 35mm 1238: Ø12 X 38 mm 1645: Ø16 X 45 mm

• Grade

PC	40H
Product name	Coating layer
PVD coating	40H: TiN coating

F Technical Information for WPDC

How to clamp the drills



Feature of corn-point system

- Convenient and quick adjustable heights when inserting the center drill
- In case the center drill brakes while in usage, it can be replaced with the bolt for adjusting cone point
- The bolt for adjusting cone point prevents chattering on the center drill

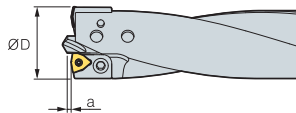
Clamping

1	2	3	4	5
Place a center drill	Clamp insert and cartridge	Adjust the center drill with the bolt for adjusting cone point	Clamp the center drill firmly with fixing bolt	Reassure the clamp with bolt for adjusting cone point

- ※ Use safety covers for your safety when clamping the center drill and insert
- ※ When machining, be careful of the drill disk

Length of the 'a' part of center drill

- The length of 'a' being too short can cause bad surface finish or high cutting load
- On the other hand, the length of 'a' being too long can make tool failure and chattering while drilling

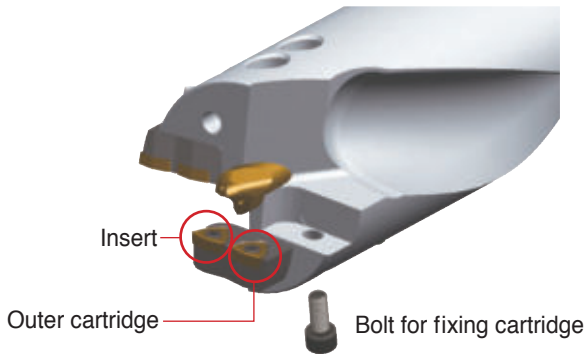


Diameter (ØD)	Length of the 'a' part of center drill		
	Steel	Alloy steel	Non-ferrous metal
25~30	1.2	1.0	1.5
31~40	1.5	1.3	1.8
41~50	1.8	1.5	2.2
51~59	2.2	1.8	2.5
60~75	2.5	2.0	2.8
76~80	3.0	2.5	3.5



Adjusting diameter of cartridge type drill

- 1) Disassemble a cartridge from the holder by loosening the bolt fixed for outer cartridge
- 2) Machine after calculating the hole size on the side of the outer cartridge
- 3) Trim the sharp part after machining
- 4) Clamp the bolt for fixing cartridge without any gap in between the holder and the machined outer cartridge



1) Range of adjustable drill diameter

- ① Single cartridge type (Drill diameter $\varnothing 41 \sim \varnothing 59$) \rightarrow -1.0 mm
- ② Dual cartridge type (Drill diameter $\varnothing 60 \sim \varnothing 80$) \rightarrow -5.0 mm

2) Diameter of the standard drills is provided with maximum size of standards

Ex) WPDC6570-40-6.5 \rightarrow Drill diameter 70.0 mm

Ex) How to adjust drill diameter to $\varnothing 66.0$ machining with WPDC6570-40-8

\rightarrow To make the drill diameter of outer cartridge to $\varnothing 66.0$, machine 2.0 mm ($\varnothing 70.0 - \varnothing 66.0 = 4 \rightarrow 4 \div 2 = 2$ (radius))

Recommended cutting condition

Workpiece			Chip breaker	Grade	vc (m/min)	Aspect ratio (L/D) = 5D, 6.5D, 8D						
ISO	Workpiece	HB				Feed rate (mm/rev) per drill dia. (mm)						
						$\sim \varnothing 30$	$\varnothing 31 \sim \varnothing 40$	$\varnothing 41 \sim \varnothing 50$	$\varnothing 51 \sim \varnothing 59$	$\varnothing 60 \sim \varnothing 75$	$\varnothing 76 \sim \varnothing 80$	
P	Carbon steel	Low carbon steel ($\sim 0.25\%$)	80~180	C21N	PC5335	190 (160~220)	0.07~0.11	0.08~0.12	0.10~0.14	0.12~0.16	0.12~0.16	0.12~0.16
		High carbon steel (0.25%~)	180~280	C21N	PC5335	140 (110~170)	0.07~0.11	0.08~0.12	0.10~0.14	0.12~0.16	0.12~0.16	0.12~0.16
	Alloy steel	Low alloy steel	140~260	C21N	PC5335	130 (100~160)	0.08~0.12	0.08~0.12	0.10~0.14	0.12~0.18	0.12~0.18	0.12~0.18
		High alloy steel	50~260	C21N	PC5335	100 (70~130)	0.06~0.10	0.08~0.12	0.08~0.12	0.10~0.16	0.10~0.16	0.10~0.16
M	Stainless steel	Stainless steel	135~275	C21N	PC5335	100 (70~130)	0.06~0.10	0.08~0.12	0.10~0.12	0.12~0.14	0.12~0.14	0.12~0.14
K	Cast iron	Gray cast iron	150~220	C21N	PC5335	160 (130~190)	0.09~0.15	0.10~0.16	0.12~0.2	0.14~0.22	0.14~0.22	0.14~0.22
		Ductile cast iron	200~300	C21N	PC5335	140 (170~110)	0.09~0.15	0.10~0.16	0.12~0.2	0.14~0.22	0.14~0.22	0.14~0.22
		Malleable cast iron	130~230	C21N	PC5335	150 (180~120)	0.09~0.15	0.10~0.16	0.12~0.2	0.14~0.22	0.14~0.22	0.14~0.22
N	Non-ferrous metal	Aluminum	30~150	C21N	PC5335	300 (250~350)	0.08~0.12	0.10~0.14	0.12~0.16	0.14~0.18	0.14~0.18	0.14~0.18
		Alloyed copper	150~160	C21N	PC5335	250 (200~300)	0.08~0.12	0.10~0.14	0.12~0.16	0.14~0.18	0.14~0.18	0.14~0.18
S	Heat resistant alloy	Heat resistant alloy	130~400	C21N	PC5335	50 (70~30)	0.05~0.08	0.05~0.08	0.06~0.10	0.06~0.10	0.06~0.10	0.06~0.10

Parts of WPDC type indexable drills

Designation	ØD	Insert			Center drill			Cartridge										
		Insert	Screw	Wrench	Center drill	fixed bolt	cone point bolt	Inner	Outer	Fixed bolt								
WPDC250-32-□	25	WC□T030204-C21N	FTKA02206	TW06S	CD0630	KHA0508	KHC0510											
WPDC260~280-32-□	26~28	WC□T040204-C21N	FTNA02555	TW07S							KHA0510							
WPDC290~300-32-□	29~30					WC□T050308-C21N	FTKA0307				TW09S	KHA0610						
WPDC310~350-32-□	31~35	KHA0612																
WPDC360~400-32-□	36~40	KHC0610																
WPDC410-40-□	41	WC□T06T308-C21N	FTKA03508	TW15S	CDH1035	KHA0812	KHC0812				CWP4145C	CWP410P	BHA0510					
WPDC420-40-□	42											CWP420P						
WPDC430-40-□	43											CWP430P						
WPDC440-40-□	44											CWP440P						
WPDC450-40-□	45											CWP450P						
WPDC460-40-□	46							CWP460P	BHA0512									
WPDC470-40-□	47							CWP470P										
WPDC480-40-□	48							CWP480P										
WPDC490-40-□	49							CWP490P										
WPDC500-40-□	50							CWP500P										
WPDC510-40-□	51							WC□T080408-C21N	FTKA0411K	TW15S		CDH1238		KHA1015	KHC1016	CWP5155C	CWP510P	BHA0612
WPDC520-40-□	52																CWP520P	
WPDC530-40-□	53																CWP530P	
WPDC540-40-□	54	CWP540P																
WPDC550-40-□	55	CWP550P																
WPDC560-40-□	56	CWP560P	BHA0614															
WPDC570-40-□	57	CWP570P																
WPDC580-40-□	58	CWP580P																
WPDC590-40-□	59	CWP590P																
WPDC6065-40-□	60~65	WC□T050308-C21N	FTKA0307	TW09S	CDH1645	KHA1020	KHA1020				CWP6065C		CWP6065P				BHA0510	
WPDC6570-40-□	65~70							CWP6570C	CWP6570P									
WPDC7075-40-□	70~75							CWP7075C	CWP7075P									
WPDC7580-40-□	75~80							CWP7580C	CWP7580T	BHA0612								

↻ Applicable inserts F03~04

Center Drill



(mm)

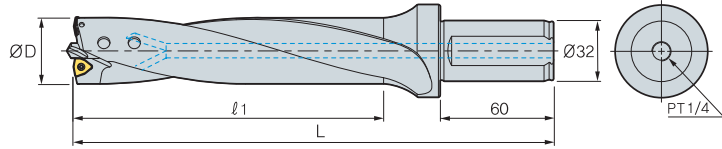
Designation	Grade	ØD	L	Oil-hole
CD 0630	PC40H	6	30	×
CD 0835	PC40H	8	35	×
CDH 1035	PC40H	10	35	○
CDH 1238	PC40H	12	38	○
CDH 1645	PC40H	16	45	○

• This is HSS with Tin coating



WPDC (5D/6.5D/8D)

Standard type



(mm)

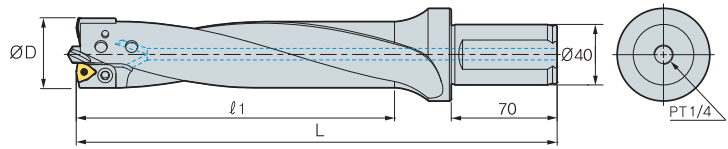
Designation	ØD	5D		6.5D		8D		Insert	Center drill	
		ℓ ₁	L	ℓ ₁	L	ℓ ₁	L			
WPDC	250-32-□	25	150	240	185	275	220	310	WC□T030204-C21N	CD0630
	260-32-□	26	150	240	185	275	220	310		
	270-32-□	27	150	240	185	275	220	310		
	280-32-□	28	150	240	185	275	220	310		
	290-32-□	29	150	240	185	275	220	310		
	300-32-□	30	150	240	185	275	220	310		
	310-32-□	31	175	265	218	308	260	350	WC□T050308-C21N	CD0835
	320-32-□	32	175	265	218	308	260	350		
	330-32-□	33	175	265	218	308	260	350		
	340-32-□	34	175	265	218	308	260	350		
	350-32-□	35	175	265	218	308	260	350		
	360-32-□	36	200	290	250	340	300	390		
	370-32-□	37	200	290	250	340	300	390		
	380-32-□	38	200	290	250	340	300	390		
	390-32-□	39	200	290	250	340	300	390		
	400-32-□	40	200	290	250	340	300	390		

↻ Applicable inserts **F04**

* We can provide if you order exact diameter
Ex) machining hole 32.5 mm • 6.5D → WPDC325-32-6.5

WPDC (5D/6.5D/8D)

Single insert cartridge type



(mm)

Designation	ØD	5D		6.5D		8D		Insert	Center drill	Cartridge		
		l ₁	L	l ₁	L	l ₁	L			Inner	Outer	
WPDC	410-40-□	41	225	330	283	388	340	445	WC□T06T308-C21N	CDH1035	CWP4145C	CWP410P
	420-40-□	42	225	330	283	388	340	445				CWP420P
	430-40-□	43	225	330	283	388	340	445				CWP430P
	440-40-□	44	225	330	283	388	340	445				CWP440P
	450-40-□	45	225	330	283	388	340	445				CWP450P
	460-40-□	46	250	355	315	420	380	485			CWP4650C	CWP460P
	470-40-□	47	250	355	315	420	380	485				CWP470P
	480-40-□	48	250	355	315	420	380	485				CWP480P
	490-40-□	49	250	355	315	420	380	485				CWP490P
	500-40-□	50	250	355	315	420	380	485				CWP500P
	510-40-□	51	275	380	348	453	420	525			CWP5155C	CWP510P
	520-40-□	52	275	380	348	453	420	525				CWP520P
	530-40-□	53	275	380	348	453	420	525				CWP530P
	540-40-□	54	275	380	348	453	420	525				CWP540P
	550-40-□	55	275	380	348	453	420	525				CWP550P
	560-40-□	56	300	405	380	485	460	565			CWP5659C	CWP560P
	570-40-□	57	300	405	380	485	460	565				CWP570P
	580-40-□	58	300	405	380	485	460	565				CWP580P
	590-40-□	59	300	405	380	485	460	565				CWP590P

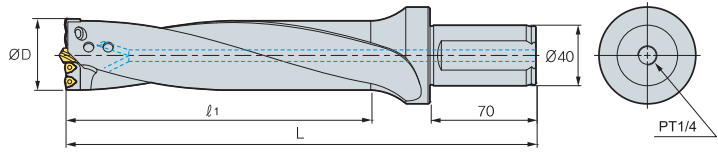
↻ Applicable inserts F04

* We can provide if you order exact diameter
Ex) machining hole 47.5 mm * 5D -> WPDC475-40-5



WPDC (5D/6.5D/8D)

Dual insert cartridge type



(mm)

Designation	ØD	5D		6.5D		8D		Insert	Center drill	Cartridge	
		l ₁	L	l ₁	L	l ₁	L			Inner	Outer
WPDC	6065-40-□	60~65	325 430	423 528	520 625	WC□T050308-C21N	CDH1238	CWP6065C	CWP6065P		
	6570-40-□	65~70	350 455	455 560	560 665			CWP6570C	CWP6570P		
	7075-40-□	70~75	375 480	488 593	600 705			CWP7075C	CWP7075P		
	7580-40-□	75~80	400 505	520 625	640 745			WC□T06T308-C21N	CDH1645	CWP7580C	CWP7580P

↻ Applicable inserts **F04**

* We can provide if you order exact diameter
Ex) machining hole 70.5 mm * 6.5D -> WPDC705-40-6.5

F Technical Information for Indexable Reamer

Mass production and High performance

Indexable Reamer

- Suitable for mass production and high performance
- Using PCD or coated insert for high speed machining
- Excellent high accuracy and adjustable machining hole
- Using accuracy chucking system (Hydraulic, rotating type arbor)
- Using inner coolant type machine to evacuate chips
- Using suitable holder and insert
- As insert setting, using setting fixture (KIRSD-210)

Code system

• Insert

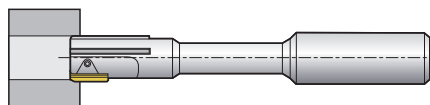
RI	16	-	B	06
Type Reamer Insert	Insert size 15: 15.0 × 3.0 16: 16.0 × 3.5 17: 17.0 × 4.5 22: 22.0 × 6.5		Insert reed type A: Excellent surface finish, low cutting condition B: General surface finish, high cutting condition C: Aluminum and copper alloy D: Blind hole, low feed	Angle of C/B 00: 0°, Cast iron 06: 6°, General steel 12: 12°, Stainless, Al

• Holder

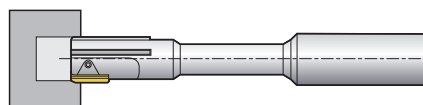
IR	T	12.000	-	16	135	-	16
Type Indexable Reamer	Application T: Throughout hole machining B: Blind hole machining	Reamer dia. 12.000: Ø12.0 mm		Shank Dia. 16: Ø16 mm	length 135: 135		Insert size 15: 15.0 × 3.0 16: 16.0 × 3.5 17: 17.0 × 4.5 22: 22.0 × 6.5

Application

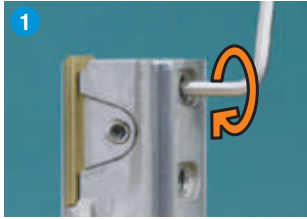
Throughout hole machining (IRT type)



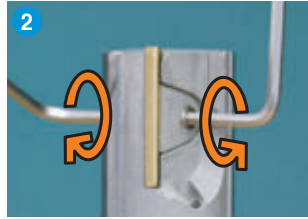
Stuffed hole machining (IRB type)



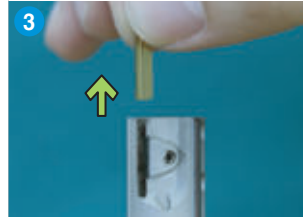
How to set an insert



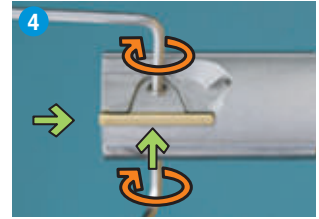
1. Screw the wedge screw counter clockwise with the exclusive wrench



2. Screw the clamp screw
 ① Top side: counter clockwise
 ② Lower side: clockwise



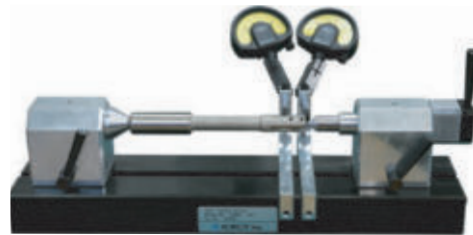
3. Remove the insert and clean the pocket



4. Put the insert up to the edge stopper and clamp the insert
 ① Top side: clockwise
 ② Lower side: counterclockwise

Exclusive fixture

- Designation: KIRSD-210
- Maximum diameter of reamer: $\varnothing 60 \times 210$ mm
- The fixture is also available for setting special reamer and mono tool
- Special reamers (out of maximum setting range) are available quotation



How to set an insert with fixture



1. Adjust the gauge to '0'



2. Rotate the reamer for the insert to touch the gauge



3. Set the back taper and adjust the insert height with screw the wedge screw
 ① Top side of insert: $+0.015 \sim +0.020$ mm
 ② Bottom side of insert: $+0.005 \sim +0.010$ mm
 ③ Back taper: $0.010 \sim 0.015$ mm

Back taper

- Ensures low cutting load and excellent surface finish with good chip evacuation
- Inaccurate back taper could cause unstable machining with wear of insert
- The size of back taper of insert down side should be less to $0.010 \sim 0.015$ mm than one of insert upper side

Insert setting with a micrometer



- Lathe with both centers or bench center are also available

Notice: The setting with a micrometer is not recommended due to chipping on the cutting edge

F Technical Information for Indexable Reamer

Recommended cutting condition

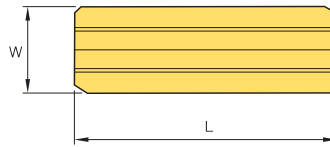
Workpiece	Insert type		Feed rate (mm/rev) per drill dia. (mm)	Cutting speed v_c (m/min)		
	Rake angle	Lead type		Coated	Uncoated	Cermet
Carbon steel General steel	6	A	0.1~0.4	60~80	40~60	110~160
		B	0.1~0.3	80~120	60~80	
		D	0.05~0.2			
Mild steel Alloy steel	6	A	0.1~0.4	40~60	20~40	110~160
		B	0.1~0.3	80~120	60~80	
		D	0.05~0.2			
High alloy steel Tool steel	6	A	0.1~0.4	20~60	20~40	20~60
		B	0.1~0.3	40~80	40~60	40~80
		D	0.05~0.2			
Stainless steel	12	A	0.1~0.3	40~60	20~40	40~60
		B	0.1~0.2	60~80	40~60	60~80
		D	0.05~0.2			
Cast iron	0.6	A	0.1~0.3	60~100	40~60	
		B	0.1~0.25	80~120	60~80	
		D	0.05~0.2			
Alloyed aluminum	12	B	0.1~0.3		160~200	
		C	0.15~0.3		150~250	
		D	0.05~0.2		110~200	
Alloyed copper	0	B	0.1~0.2		80~100	
		D	0.05~0.2			
Non-ferrous alloy	0	B	0.1~0.3		10~70	

Parts

Reamer size	Clamp	Wedge	Clamp Screw	Wedge Screw	Clamp Wrench	Wedge Wrench
10.0~11.9	CV 15	AW2430	DHA0308	HSO306	HW15L	HW15L
12.0~17.9	CV 16	AW2435				
18.0~27.9	CV 17	AW3240	DHA0409	HSO406	HW20L	HW20L
28.0~31.9	CV 22	AW3260				



Available insert



Designation	Grade			Dimensions			Lead type	Rake angle (α°)
	K10 (Uncoated)	BPK110 (TiAlN)	BPK210 (TiN)	L	W	S		
RI	15-A06		○	15	3.0	1.5	A	6°
	15-A12	○		15	3.0	1.5	A	12°
	15-B06		○	15	3.0	1.5	B	6°
	15-B12		○	15	3.0	1.5	B	12°
	16-A06		○	16	3.5	1.5	A	6°
	16-A12	○		16	3.5	1.5	A	12°
	16-B06		○	16	3.5	1.5	B	6°
	16-B12		○	16	3.5	1.5	B	12°
	17-A06		○	17	4.5	2.0	A	6°
	17-A12	○		17	4.5	2.0	A	12°
	17-B06		○	17	4.5	2.0	B	6°
	17-B12		○	17	4.5	2.0	B	12°
	22-A06		○	22	6.5	3.0	A	6°
	22-A12	○		22	6.5	3.0	A	12°
	22-B06		○	22	6.5	3.0	B	6°
	22-B12		○	22	6.5	3.0	B	12°

※ ○ This is recommended grade as for insert type

Angle of chip breaker

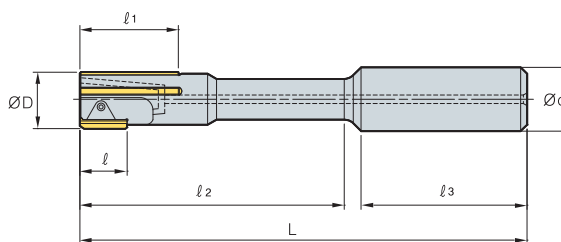
Division	00	06	12
Shape			
Application	For cast iron machining	For general machining	For stainless and aluminum machining

Insert lead type

Type	Shape	Working condition	Type	Shape	Working condition
A		For excellent surface, low cutting condition	C		For aluminum and copper alloy machining
B		For general application, high cutting condition	D		For blind hole machining, low feed

IRT

Throughout hole



(mm)

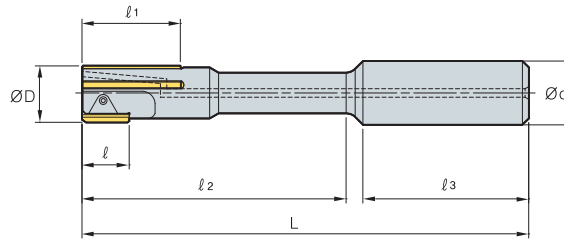
	Designation	ØD	ℓ	ℓ ₁	ℓ ₂	ℓ ₃	L	Ød	Insert
IRT	10.000-16125-15	10	15	30	75	45	125	16	RI 15
	11.000-16125-15	11	15	30	75	45	125	16	RI 15
	12.000-16135-16	12	16	30	85	45	135	16	RI 16
	13.000-16135-16	13	16	30	85	45	135	16	RI 16
	14.000-16135-16	14	16	30	85	45	135	16	RI 16
	15.000-16135-16	15	16	30	85	45	135	16	RI 16
	16.000-20155-16	16	16	30	100	50	155	20	RI 16
	17.000-20155-16	17	16	30	100	50	155	20	RI 16
	18.000-20155-17	18	17	30	100	50	155	20	RI 17
	19.000-20155-17	19	17	30	100	50	155	20	RI 17
	20.000-25165-17	20	17	30	110	56	165	25	RI 17
	21.000-25165-17	21	17	30	110	56	165	25	RI 17
	22.000-25165-17	22	17	30	110	56	165	25	RI 17
	23.000-25165-17	23	17	30	110	56	165	25	RI 17
	24.000-25165-17	24	17	30	110	56	165	25	RI 17
	25.000-25165-17	25	17	30	110	56	165	25	RI 17
	26.000-25165-17	26	17	30	110	56	165	25	RI 17
	27.000-25165-17	27	17	30	110	56	165	25	RI 17
	28.000-32165-22	28	22	30	110	56	165	32	RI 22
	29.000-32165-22	29	22	30	110	56	165	32	RI 22
30.000-32165-22	30	22	30	110	56	165	32	RI 22	
31.000-32165-22	31	22	30	110	56	165	32	RI 22	

➔ Applicable inserts F85



IRB

Stuffed hole



(mm)

	Designation	ØD	ℓ	ℓ ₁	ℓ ₂	ℓ ₃	L	Ød	Insert
IRB	10.000-16125-15	10	15	30	75	45	125	16	RI 15
	11.000-16125-15	11	15	30	75	45	125	16	RI 15
	12.000-16135-16	12	16	30	85	45	135	16	RI 16
	13.000-16135-16	13	16	30	85	45	135	16	RI 16
	14.000-16135-16	14	16	30	85	45	135	16	RI 16
	15.000-16135-16	15	16	30	85	45	135	16	RI 16
	16.000-20155-16	16	16	30	100	50	155	20	RI 16
	17.000-20155-16	17	16	30	100	50	155	20	RI 16
	18.000-20155-17	18	17	30	100	50	155	20	RI 17
	19.000-20155-17	19	17	30	100	50	155	20	RI 17
	20.000-25165-17	20	17	30	110	56	165	25	RI 17
	21.000-25165-17	21	17	30	110	56	165	25	RI 17
	22.000-25165-17	22	17	30	110	56	165	25	RI 17
	23.000-25165-17	23	17	30	110	56	165	25	RI 17
	24.000-25165-17	24	17	30	110	56	165	25	RI 17
	25.000-25165-17	25	17	30	110	56	165	25	RI 17
	26.000-25165-17	26	17	30	110	56	165	25	RI 17
	27.000-25165-17	27	17	30	110	56	165	25	RI 17
	28.000-32165-22	28	22	30	110	56	165	32	RI 22
	29.000-32165-22	29	22	30	110	56	165	32	RI 22
30.000-32165-22	30	22	30	110	56	165	32	RI 22	
31.000-32165-22	31	22	30	110	56	165	32	RI 22	

↻ Applicable inserts **F85**

TOOLING SYSTEM

G



Tooling System

G02	Tooling System Index	G49	FMA
G04	DHE/S	G50	FMC
G07	DHE	G52	MD
G11	DHC/DHJ Collet	G54	EXT Bar
G12	DSC	G54	RDC Bar
G20	NPM	G55	FBH/B
G23	DCS/DC/TC	G62	DBCA
G24	Collet Chuck Series	G66	DBC
G25	SDC/P	G68	SMB
G30	DSK	G70	KMB
G32	GSK	G72	SMH
G34	GERC	G74	TBCA
G36	ER	G79	TBC
G37	ER/L	G82	FBC
G38	RTJW	G85	SAH
G40	NPU	G86	Angular Head
G41	DST	G94	DZC
G43	TER Tap Collet	G95	DCJ
G44	DTN	G96	DCL
G46	TCA Tap Adaptor	G97	DAMPHNG PRO
G47	SLA	G104	Others

H Tooling System Index

DHE/S

Slim hydraulic expansion chuck



G5

DHE

Hydraulic expansion chuck



G8

DSC

Shrinking chuck



G14

NPM

New power milling chuck



G21

SDC/P

Precision collet chuck for multi purpose machining



G25

DSK

Slim type collet chuck



G30

GSK

Great speed slim type collet chuck



G32

HC Collet

HC slim collet



G33

GERC

GERC collet



G35

ER Collet

ER collet



G36

ER/L

Lock collet for ER collet chuck



G37

RTJW

Jet coolant disk



G39

NPU

Drill chuck



G40

DST

High speed synchro tapping chuck



G42

TER

TER collet ER tap collet



G43

DTN

Tapping holder



G45

TCA

Tap adapter



G46

SLA

Side lock arbor



G47

FMA

Face mill arbor



G49

FMC

Face mill arbor



G50

MD

Modular arbor



G52

EXT

Extension bar



G54

RDC

Reducer bar



G54

FBH/B

FBH Back boring & balanced type



G55



DBCA

New balance cut tool



G63

DBC

Balance cut tool (Rough boring)



G66

SMB

Small micro boring bar



G68

KMB

Micro boring



G70

SMH

Small micro boring bar (precision type)



G72

TBCA

Wide diameter boring system



G75

TBC

Balance cut tool for Rough boring



G80

FBC

Balance cut tool for Fine boring



G83

SAH

Slim angular head



G85

MAH

MAH for mold (0°-90°)
Rigidity-reinforced angular head



G88

KHU

Collet type angular head (0° - 90°)



G89

HARG

HRAG (90° fixed)
Rigidity-reinforced angular head



G90

KAG

Attachment type KAG



G91

KAH

Modular type KAH (90° type)
Fixed angle-type angular head



G92

KAC

Modular type KAC (45° type)
Fixed angle-type angular head



G93

DZC

Zero fit collet



G94

DCJ

DINE Jetcoolant collet



G95

DCL

Lock collet for milling chuck



G96

FMA

DAMPING PRO



G99, 101

FMC

DAMPING PRO



H100, 102, 103

Slim hydraulic expansion chuck

DHE/S

- Optimized chuck for machining that requires high-quality surface roughness and accuracy
- Suitable for challenging mold and automotive parts machining that involves complicated shapes and a lot of interferences
- Ideal for metal impeller machining, which requires deep penetration
- Enables easy tool connection without any additional connecting device
- Easy to perform fine boring operations (0.02-0.2 mm)
- Application scope: milling, drilling, reaming



Code system

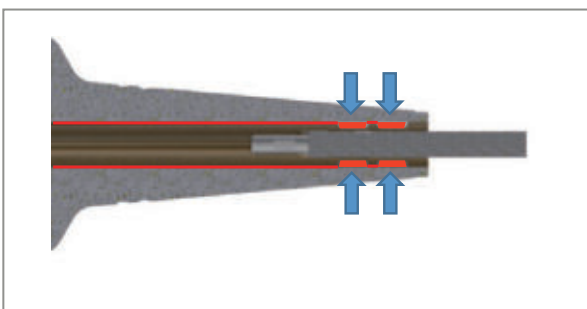


Recommended Machining Works



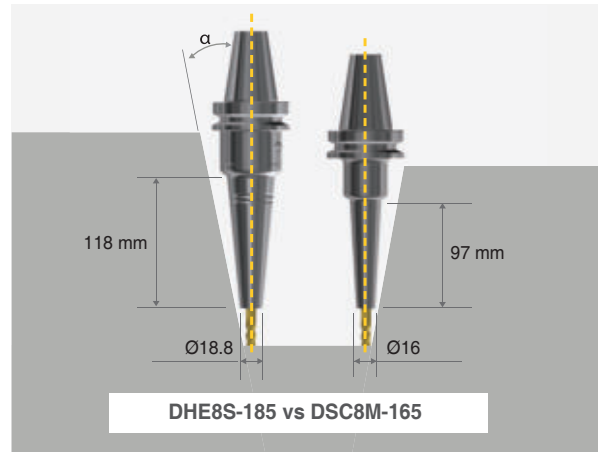
- Optimized for machining that requires high precision
- Enables challenging narrow and deep machining
- Products that require fine boring operations

Stable Clamping force



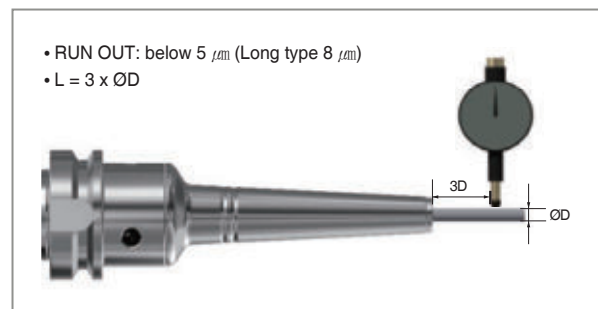
- Maintains high clamping force and good accuracy by holding the tool at two points

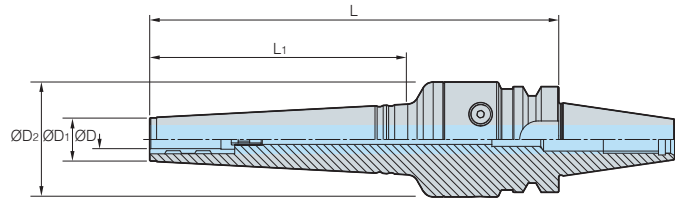
Product Comparison




- Length and thickness are the same as those of DSC/M Type (if the tool projection length is 40 mm, difference of α = around 2°)
- Longer gauge line and higher rigidity (versus the DSC/M Type)
- Ideal for mold machining due to its 3-degree taper shape


High-precision



BT-DHE/S

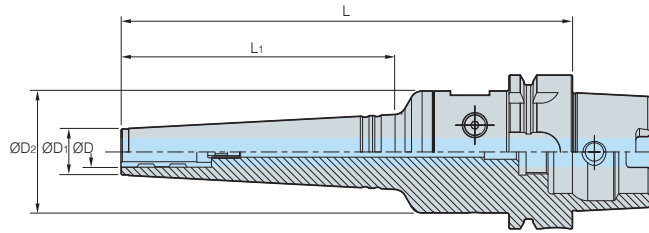
(mm)

Designation		ØD	ØD ₁	ØD ₂	L	L ₁	RPM	Run-out Based on 3D	 kg
BT30 -	DHE6S-115	6	16.8	50	115	50	25,000	5 µm	1.1
	DHE6S-180	6	16.8	50	180	115	25,000	8 µm	1.4
	DHE8S-115	8	18.8	50	115	50	25,000	5 µm	1.1
	DHE8S-180	8	18.8	50	180	115	25,000	8 µm	1.4
	DHE10S-120	10	20.8	50	120	55	25,000	5 µm	1.4
	DHE10S-180	10	20.8	50	180	115	25,000	8 µm	1.9
	DHE12S-130	12	22.8	50	130	65	25,000	5 µm	1.2
	DHE12S-180	12	22.8	50	180	115	25,000	8 µm	1.6
BT40 -	DHE6S-120	6	16.8	50	120	50	15,000	5 µm	1.7
	DHE6S-185	6	16.8	50	185	115	15,000	8 µm	2.0
	DHE8S-120	8	18.8	50	120	50	15,000	5 µm	2.0
	DHE8S-185	8	18.8	50	185	115	15,000	8 µm	2.0
	DHE10S-125	10	20.8	50	125	55	15,000	5 µm	1.6
	DHE10S-185	10	20.8	50	185	115	15,000	8 µm	2.0
	DHE12S-135	12	22.8	50	135	65	15,000	5 µm	1.8
	DHE12S-185	12	22.8	50	185	115	15,000	8 µm	2.2

 Spare Part **G06**

• Through coolant system installed

HSK-DHE/S



(mm)

Designation		ØD	ØD ₁	ØD ₂	L	L ₁	RPM	Run-out Based on 3D	kg
HSK63A -	DHE6S-120	6	16.8	50	120	50	10,000	5 µm	1.4
	DHE6S-185	6	16.8	50	185	115	10,000	8 µm	1.7
	DHE8S-120	8	18.8	50	120	50	10,000	5 µm	1.4
	DHE8S-185	8	18.8	50	185	115	10,000	8 µm	1.8
	DHE10S-125	10	20.8	50	125	55	10,000	5 µm	1.5
	DHE10S-185	10	20.8	50	185	115	10,000	8 µm	1.8
	DHE12S-135	12	22.8	50	135	65	10,000	5 µm	1.8
	DHE12S-185	12	22.8	50	185	115	10,000	8 µm	1.8

• Through coolant system installed

Parts

Basic					
Division		Clamp bolt	Wrench	Division	Adjust screw
Parts				Parts	
Designation				Designation	
BT30	DHE/S 6, 8, 10, 12	BTF1010	DHETW-5	DHE/S 6, 8, 10	DHE-M5 (ADJ)
BT40/HSK63A	DHE/S 6, 8, 10, 12	BTF1010	DHETW-5	DHE/S 12	DHE-M10 (ADJ)



Hydraulic expansion chuck

DHE

- Ideal for mold making and machining automobile components & precise parts due to high precision machining
- Improved surface roughness due to vibration proof by hydraulic chamber
- Reduced replacement time and tiredness of worker with the use of T wrench for removal
- Applicable shank diameter: Ø6~32



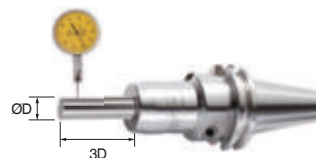
Code system



Features

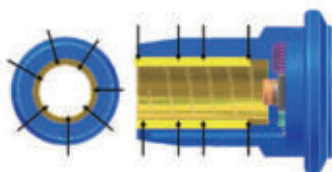
High accuracy provides long tool life due to reduced wear and hydraulic room enhances a surface roughness by lessening vibrations

- RUN OUT: under 5 μm
- L = 3 x ØD
- Shank: Tolerance of ØD: h6



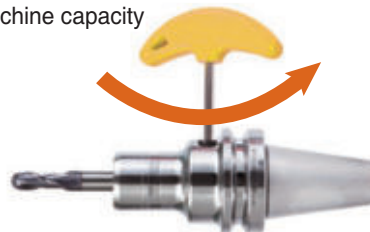
Internal sealing structure (Durability)

- Internal sealing system protects the chuck against dust, cutting oil, lubricant and chips getting into it
- Maintaining clamping force and accuracy for a long time



With simple t-wrench, very easy to change a tool

- Clamping structure for easy operation (Convenience)
- Decrease of worker's fatigue
- Improving machine capacity



Shank	Grade	Max.rpm
BT50, HSK100A	G6.3	8,000
BT40, HSK63A		10,000
BT30, SK30		15,000

Stable clamping

The clearance between holder and tool is fixed by hydraulic pressure



BT-DHE

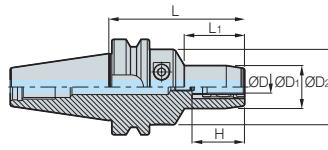


Fig. 1

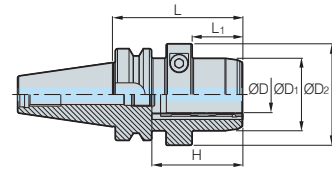


Fig. 2

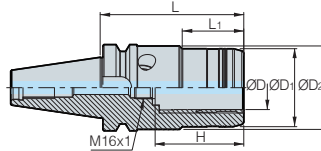


Fig. 3

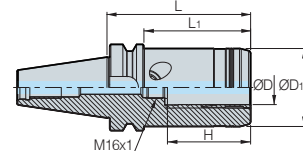


Fig. 4

(mm)

Designation	ØD	ØD ₁	ØD ₂	L	L ₁	H	Adjust screw	kg	Fig.	
BT30 -	DHE6-65	6	29	46	65	33	30~39.8	M5	0.7	1
	DHE8-65	8	31	46	65	33	30~39.8	M5	0.7	1
	DHE10-65	10	32	46	65	34	35~44.8	M5	0.7	1
	DHE12-70	12	35	46	70	34	41~50.8	M5	0.8	1
	DHE14-90	14	36	46	90	40	43~52.8	M5	1.0	1
	DHE16-90	16	40	46	90	45	46~55.8	M5	1.0	1
	DHE18-90	18	42	46	90	40	49~58.8	M5	1.1	1
	DHE20-90	20	44	46	90	45	49~58.8	M5	1.1	1
BT40 -	DHE6-90	6	29	50	90	40	30~39.8	M5	1.4	1
	DHE6-140	6	29	50	140	40	30~39.8	M5	2.2	1
	DHE8-90	8	31	50	90	40	30~39.8	M5	1.4	1
	DHE8-140	8	31	50	140	40	30~39.8	M5	2.2	1
	DHE10-90	10	33	50	90	40	35~44.8	M5	1.5	1
	DHE10-140	10	33	50	140	40	35~44.8	M5	2.2	1
	DHE12-90	12	35	50	90	40	41~50.8	M10	1.5	1
	DHE12-140	12	35	50	140	40	41~50.8	M10	2.3	1
	DHE14-90	14	36	50	90	40	43~52.8	M10	1.5	1
	DHE14-140	14	36	50	140	40	43~52.8	M10	2.2	1
	DHE16-90	16	40	50	90	45	46~55.8	M10	1.5	1
	DHE16-140	16	40	50	140	45	46~55.8	M10	2.2	1
	DHE18-90	18	42	50	90	45	49~58.8	M10	1.5	1
	DHE18-140	18	42	50	140	45	49~58.8	M10	2.2	1
	DHE20-90	20	44	50	90	47	49~58.8	M10	1.5	1
	DHE20-140	20	44	50	140	50	49~58.8	M10	2.3	1
	DHE25-90	25	50	70	90	35	58~67.8	M16	2.0	2
	DHE25-105	25	57	-	105	78	51~61	M16	2.0	4
	DHE25-140	25	57	-	140	113	51~61	M16	2.6	4
	DHE32-90	32	63	75	90	35	58~67.8	M16	2.3	2
DHE32-105	32	57	61	105	45	55~65	M16	2.4	3	
DHE32-140	32	57	61	140	45	55~65	M16	3.0	3	

Spare Part **G10** Applicable collet **G11**

• H: Insertion depth of tool (Min.~max.) • Through coolant system installed



BT-DHE

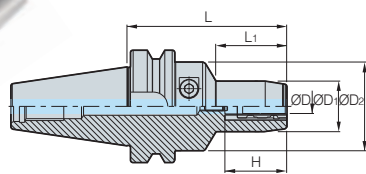


Fig. 1

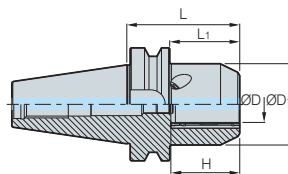


Fig. 2

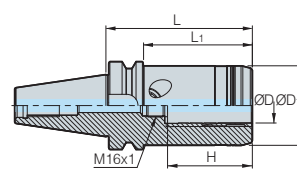


Fig. 3

(mm)

Designation	ØD	ØD ₁	ØD ₂	L	L ₁	H	Adjust screw	kg	Fig.	
BT50 -	DHE6-90	6	29	50	90	34	30~39.8	M5	3.9	1
	DHE6-140	6	29	50	140	40	30~39.8	M5	4.4	1
	DHE8-90	8	31	50	90	34	30~39.8	M5	4.2	1
	DHE8-140	8	31	50	140	40	30~39.8	M5	4.6	1
	DHE10-90	10	33	50	90	34	35~44.8	M5	3.9	1
	DHE10-140	10	33	50	140	34	35~44.8	M5	4.5	1
	DHE12-90	12	35	50	90	34	41~50.8	M10	4.0	1
	DHE12-140	12	35	50	140	34	41~50.8	M10	4.6	1
	DHE14-90	14	36	50	90	34	43~52.8	M10	3.9	1
	DHE14-140	14	36	50	140	34	43~52.8	M10	4.5	1
	DHE16-90	16	40	50	90	34	46~55.8	M10	4.1	1
	DHE16-140	16	40	50	140	34	46~55.8	M10	4.7	1
	DHE18-90	18	42	50	90	40	49~58.8	M10	4.0	1
	DHE18-140	18	42	50	140	45	49~58.8	M10	4.5	1
	DHE20-90	20	44	50	90	34	49~58.8	M10	4.0	1
	DHE20-140	20	44	50	140	47	49~58.8	M10	4.5	1
	DHE25-90	25	66	-	90	52	58~67.8	M16	4.7	2
	DHE25-150	25	57	-	150	112	51~61	M16	4.5	3
DHE32-90	32	72	-	90	52	58~67.8	M16	5.8	2	

Spare Part **G10** Applicable collet **G11**

• H: Insertion depth of tool (Min.-max.) • Through coolant system installed

HSK-DHE

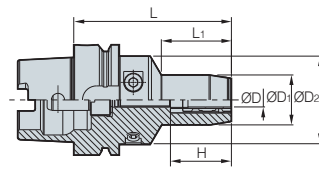


Fig. 1

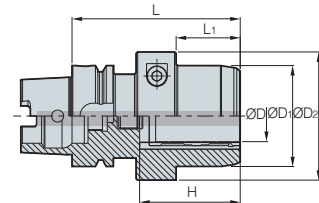


Fig. 2

(mm)

Designation	ØD	ØD ₁	ØD ₂	L	L ₁	H	Adjust Screw	RPM	kg	Fig.	
HSK63A -	DHE6-75	6	29	50	75	34	30~39.8	M5	10,000	1.0	1
	DHE8-75	8	31	50	75	34	30~39.8	M5	10,000	1.0	1
	DHE10-85	10	33	50	85	40	35~44.8	M5	10,000	1.2	1
	DHE12-90	12	35	50	90	40	41~50.8	M5	10,000	1.2	1
	DHE16-95	16	40	50	95	45	46~55.8	M10	10,000	1.3	1
	DHE20-100	20	44	50	100	50	49~58.8	M10	10,000	1.4	1
	DHE20-150	20	44	50	150	50	49~58.8	M10	10,000	2.2	1
	DHE25-110	25	50	70	110	48	56~67.8	M16	10,000	2.0	2
HSK100A -	DHE32-110	32	63	80	110	48	56~67.8	M16	10,000	2.0	2
	DHE20-105	20	44	50	105	50	49~58.8	M10	8,000	2.9	1
	DHE25-115	25	50	63	115	62	58~67.8	M16	8,000	3.2	1
DHE32-115	32	63	75	115	62	58~67.8	M16	8,000	3.8	1	

Applicable collet **G11**

• H: Insertion depth of tool (Min.-max.) • Through coolant system is optional

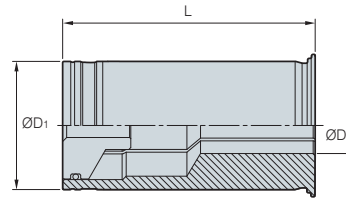
Parts

Basic					
Division		Clamp bolt	Wrench	Division	Adjust screw
Parts				Parts	
Designation				Designation	
BT30 / HSK50	DHE 6, 8, 10, 12	BTF1010	DHETW-5	DHE 6, 8, 10	DHE-M5 (ADJ)
	DHE 14, 16, 18, 20	BTF1010	DHETW-5		
BT40 / BT50 HSK63A / HSK100A	DHE 6, 8, 10, 12, 14, 16, 18, 20	BTF1010	DHETW-5	DHE 12, 14, 16, 18, 20	DHE-M10 (ADJ)
	DHE 25, 32	BTF1212-1.5	DHETW-6	DHE 25, 32	DHE-M16 (ADJ)



DHC Collet

General type



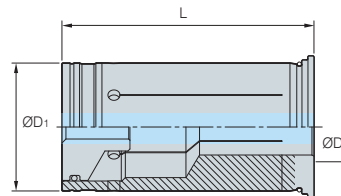
(mm)

Designation	ØD	ØD ₁	L
DHC12-3, 4, 5, 6, 8	3, 4, 5, 6, 8	12	47
DHC20-3, 4, 5, 6, 7, 8, 9, 10, 11, 12, 14, 16	3, 4, 5, 6, 7, 8, 9, 10, 11, 12, 14, 16	20	52
DHC32-6, 8, 10, 12, 14, 16, 18, 19, 20, 25	6, 8, 10, 12, 14, 16, 18, 19, 20, 25	32	63

• Through coolant system not available

DHC Collet

Accuracy type



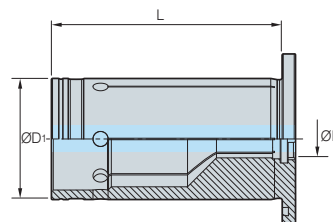
(mm)

Designation	ØD	ØD ₁	L
DHC12-3(P), 4(P), 5(P), 6(P), 8(P)	3, 4, 5, 6, 8	12	47
DHC20-3(P), 4(P), 5(P), 6(P), 7(P), 8(P), 9(P), 10(P), 11(P), 12(P), 14(P), 16(P)	3, 4, 5, 6, 7, 8, 9, 10, 11, 12, 14, 16	20	52
DHC32-6(P), 8(P), 10(P), 12(P), 14(P), 16(P), 18(P), 19(P), 20(P), 25(P)	6, 8, 10, 12, 14, 16, 18, 19, 20, 25	32	63

• Through coolant system installed

DHJ Collet

Jet coolant



(mm)

Designation	ØD	ØD	L
DHJ20-6, 8, 10, 12, 14, 16	6, 8, 10, 12, 14, 16	20	50

• Through coolant system installed



Shrinking chuck

DSC

- Use of specially heat-treated steel
- High precision machining and clamping
- Increased precision and longer tool life due to minimized overhang when machining deep grooves
- Applicable shank diameter: Ø3~32



Code System

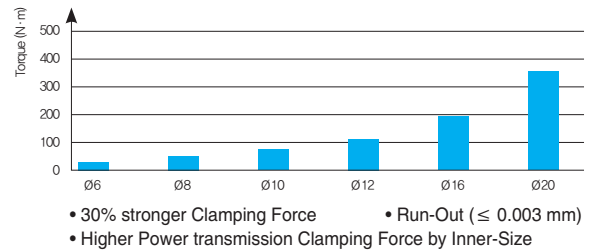
BT50 - DSC 6 - S - 165 - S					
Shank type	Holder type	Tool Dia.	Type	Length	Special
BT, HSK, ST, CS, CM	DSC: Shrinking chuck SLK: 2piece holder Collet		S: Slim M: Middle None: General		S: Curve type None: General

Mono curve type

- Integral DSC with excellent precision and balancing
- Long but stable holder design



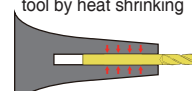
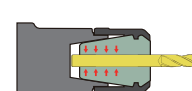
High clamping force



Symmetric design

- High clamping force



Shrinking chuck	Collet chuck
Fix the clearance between holder and tool by heat shrinking	Fix the tool by elasticity of collet
	
Thermal expansion \rightarrow Thermal shrinking Highly strong clamping	Elastic deformation Strong clamping

Slim type series

Straight type	Mono type	2piece type
		
Used by combining with various holders such as hydraulic expansion chuck, milling chuck, and collet chuck	Used with high precision as integral types	Holder + collet connection shape Connecting the holder and collet by the bolt tightening method



2-pieces type

2Piece types enable various machining operations by collet replacement and provide convenience in tool management and use based on easy and fast assembly using tightening bolts.

Figure	Accuracy	Type
		<p>Holder + collet connection shape Connecting the holder and collet by the bolt tightening method</p>

Mono type

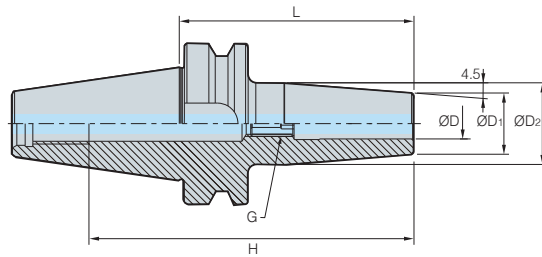
Figure	Accuracy	Type

Straight type

Figure	Accuracy	Type
		<p>Used by combining with various holders such as hydraulic expansion chuck, milling chuck, and collet chuck, etc.</p>



BT-DSC



(mm)

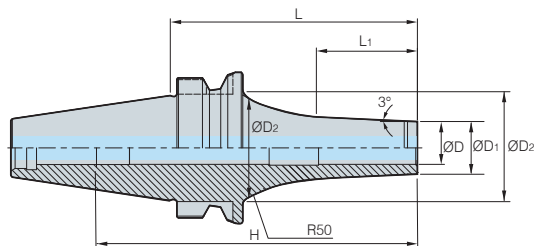
Designation	ØD	ØD ₁	ØD ₂	L	H	G	RPM	kg
BT30 - DSC3-60	3	11	18.5	60	82	-	25,000	0.4
DSC4-60	4	13	20.5	60	82	-	25,000	0.4
BT40 - DSC6-90	6	21	27	90	36	M5	20,000	1.1
DSC6-120	6	21	27	120	36	M5	20,000	1.2
DSC6-160	6	21	27	160	36	M5	20,000	1.4
DSC8-90	8	21	27	90	36	M5	20,000	1.1
DSC8-120	8	21	27	120	36	M5	20,000	1.2
DSC8-160	8	21	27	160	36	M5	20,000	1.4
DSC10-90	10	24	32	90	42	M8	20,000	1.1
DSC10-120	10	24	32	120	42	M8	20,000	1.3
DSC10-160	10	24	32	160	42	M8	20,000	1.6
DSC12-90	12	24	32	90	47	M8	20,000	1.1
DSC12-120	12	24	32	120	47	M8	20,000	1.3
DSC12-160	12	24	32	160	47	M8	20,000	1.6
DSC16-90	16	27	34	90	50	M12	20,000	1.2
DSC16-120	16	27	34	120	50	M12	20,000	1.3
DSC16-160	16	27	34	160	50	M12	20,000	1.7
DSC20-90	20	33	42	90	52	M12	20,000	1.3
DSC20-120	20	33	42	120	52	M12	20,000	1.5
DSC20-160	20	33	42	160	52	M12	20,000	2.0

Adjust screw G19

• H: Insertion depth of tool • Through coolant system installed

BT-DSC/M

Mono Curve type



(mm)

Designation	ØD	ØD ₁	ØD ₂	L	L ₁	H	RPM	kg
BT30 - DSC3M-75S	3	8	25	75	29.8	97	25,000	0.4
DSC4M-75S	4	10	25	75	31.8	97	25,000	0.4
DSC6M-75S	6	12	30	75	28.9	97	25,000	0.5
DSC8M-75S	8	14	32	75	28.9	97	25,000	0.5
DSC10M-75S	10	16	32	75	30.7	45	25,000	0.5
DSC12M-75S	12	19	32	75	33.8	45	25,000	0.5

• H: Insertion depth of tool • Not able to use the adjust screw • Through coolant system installed



BT-DSC/M

Mono type

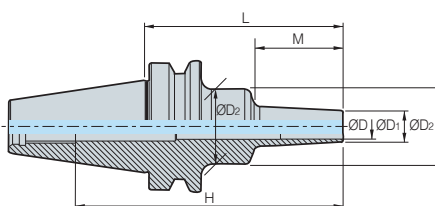


Fig. 1

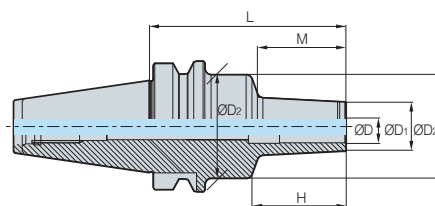




Fig. 2

(mm)

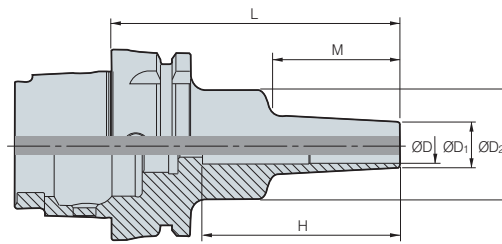
Designation	ØD	ØD ₁	ØD ₂	L	M	H	RPM	 kg	Fig.	
BT40 -	DSC3M-95	3	8	26	95	42	128	20,000	1.1	1
	DSC4M-95	4	8	26	95	42	128	20,000	1.1	1
	DSC6M-95	6	10	26	95	42	128	20,000	1.0	1
	DSC6M-120	6	10	26	120	67	153	20,000	1.0	1
	DSC6M-160	6	10	36	160	97	193	20,000	1.2	1
	DSC8M-95	8	13	36	95	42	128	20,000	1.3	1
	DSC8M-120	8	13	36	120	67	153	20,000	1.3	1
	DSC8M-160	8	13	36	160	97	193	20,000	1.3	1
	DSC10M-95	10	16	36	95	42	128	20,000	1.1	1
	DSC10M-120	10	16	36	120	67	153	20,000	1.1	1
	DSC10M-160	10	16	36	160	97	193	20,000	1.3	1
	DSC12M-95	12	19	36	95	42	128	20,000	1.1	1
	DSC12M-120	12	19	36	120	67	153	20,000	1.2	1
	DSC12M-160	12	19	36	160	97	193	20,000	1.4	1
	DSC16M-95	16	24	50	95	42	47	20,000	1.3	2
DSC16M-120	16	24	50	120	67	47	20,000	1.4	2	
DSC16M-160	16	24	50	160	97	47	20,000	1.7	2	
DSC20M-95	20	29	50	95	42	55	20,000	1.3	2	
DSC20M-120	20	29	50	120	67	55	20,000	1.5	2	
DSC20M-160	20	29	50	160	97	55	20,000	1.9	2	
BT50 -	DSC6M-110	6	10	26	110	42	163	15,000	3.5	1
	DSC6M-160	6	10	36	160	97	213	15,000	3.6	1
	DSC8M-110	8	13	36	110	42	163	15,000	3.7	1
	DSC8M-160	8	13	36	160	97	213	15,000	3.7	1
	DSC10M-110	10	16	36	110	42	163	15,000	3.7	1
	DSC10M-160	10	16	36	160	97	213	15,000	3.7	1
	DSC12M-110	12	19	36	110	42	163	15,000	3.7	1
	DSC12M-160	12	19	50	160	97	213	15,000	4.0	1
	DSC16M-110	16	24	50	110	42	163	15,000	3.9	1
	DSC16M-160	16	24	50	160	97	213	15,000	4.1	1
	DSC20M-110	20	29	50	110	42	55	15,000	3.9	2
	DSC20M-160	20	29	50	160	97	55	15,000	4.2	2

 Adjust screw G19

• H: Insertion depth of tool • Through coolant system installed

HSK-DSC/M

Mono type



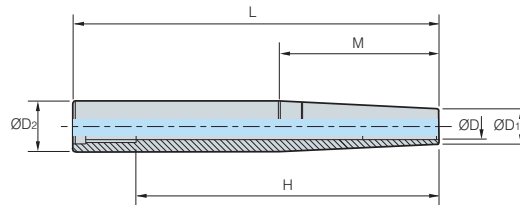
(mm)

Designation	ØD	ØD ₁	ØD ₂	L	M	H	RPM	kg	
HSK63A -	DSC6M-95	6	10	26	95	42	73	20,000	0.7
	DSC8M-95	8	13	36	95	42	39	20,000	0.8
	DSC10M-120	10	16	36	120	67	45	20,000	0.8
	DSC12M-120	12	19	36	120	67	45	20,000	0.9
	DSC16M-120	16	24	50	120	67	47	20,000	1.1

• H: Insertion depth of tool • Not able to use the adjust screw • Through coolant system is optional

ST-DSC/M

Straight Shank Shrinking Chuck



(mm)

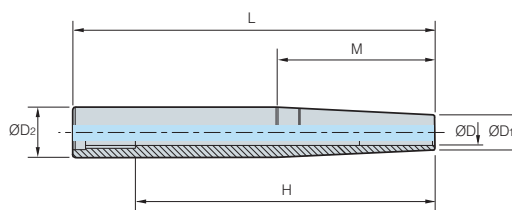
Designation	ØD	ØD ₁	ØD ₂	L	M	H	kg	
ST16 -	DSC6M-115	6	10	16	115	50	95	0.1
	DSC6M-140	6	10	16	140	60	120	0.1
ST20 -	DSC6M-175	6	10	20	175	95	155	0.2
	DSC8M-145	8	13	20	145	70	125	0.2
	DSC10M-120	10	16	20	120	50	45	0.2
ST25 -	DSC8M-175	8	13	25	175	105	155	0.4
	DSC10M-145	10	16	25	145	75	45	0.4
	DSC10M-175	10	16	25	175	105	45	0.4
	DSC12M-120	12	19	25	120	50	45	0.3
	DSC12M-150	12	19	25	150	80	45	0.4
ST32 -	DSC16M-175	16	24	25	175	50	47	0.5
	DSC20M-175	20	29	32	175	50	55	0.8

• H: Insertion depth of tool • Not able to use the adjust screw • Through coolant system installed



ST-DSC/S

Straight Shank Shrinking Chuck



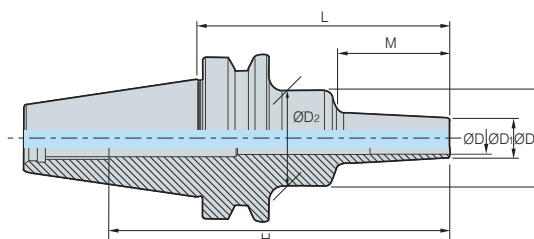
(mm)

Designation	ØD	ØD ₁	ØD ₂	L	M	H	
ST16 -	DSC6S-115	6	9	16	115	55	95
	DSC6S-140	6	9	16	140	70	120
	DSC8S-115	8	11	16	115	50	95
ST20 -	DSC6S-175	6	9	20	175	105	155
	DSC8S-175	8	11	20	175	85	155
	DSC10S-145	10	13	20	145	75	77
	DSC12S-120	12	15	20	120	50	52
ST32 -	DSC12S-315	12	15	32	315	185	295


• H: Insertion depth of tool • Not able to use the adjust screw • Through coolant system installed

BT-DSC/S

Mono slim type



(mm)

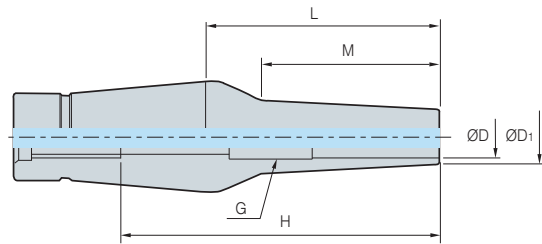
Designation	ØD	ØD ₁	ØD ₂	L	M	H	RPM		
BT30 -	DSC6S-60	6	9	20	60	22	82	25,000	0.4
	DSC6S-80	6	9	20	80	42	102	25,000	0.5
	DSC6S-120	6	9	25	120	67	142	25,000	0.5
BT40 -	DSC6S-95	6	9	26	95	42	128	20,000	1.0
	DSC6S-120	6	9	26	120	67	153	20,000	1.0
	DSC6S-160	6	9	36	160	97	193	20,000	1.2
	DSC8S-95	8	11	36	95	42	128	20,000	1.1
	DSC8S-120	8	11	36	120	67	153	20,000	1.1
	DSC8S-160	8	11	36	160	97	193	20,000	1.2
	DSC10S-95	10	13	36	95	42	128	20,000	1.0
	DSC10S-120	10	13	36	120	67	153	20,000	1.1
	DSC10S-160	10	13	36	160	97	193	20,000	1.2
	DSC12S-95	12	15	36	95	42	128	20,000	1.1
	DSC12S-120	12	15	36	120	67	153	20,000	1.1
	DSC12S-160	12	15	36	160	97	193	20,000	1.2
BT50 -	DSC6S-110	6	9	26	110	42	166	15,000	3.5
	DSC6S-160	6	9	36	160	97	216	15,000	3.6
	DSC8S-110	8	11	36	110	42	166	15,000	3.6
	DSC8S-160	8	11	36	160	97	216	15,000	3.6
	DSC10S-110	10	13	36	110	42	166	15,000	3.6
	DSC10S-160	10	13	36	160	97	216	15,000	3.6
	DSC12S-110	12	15	36	110	42	166	15,000	3.6
	DSC12S-160	12	15	36	160	97	216	15,000	3.7

• H: Insertion depth of tool • Not able to use the adjust screw • Through coolant system installed




CS/CM

2-pieces type




(mm)

Designation	ØD	ØD ₁	L	M	H		
CS12	6-35	6	9	35	22	55	0.1
	6-80	6	9	80	67	100	0.2
	6-110	6	9	110	97	130	0.2
	8-35	8	11	35	22	55	0.1
	8-110	8	11	110	97	130	0.3
	10-35	10	13	35	22	45	0.1
	10-80	10	13	80	67	65	0.2
	10-110	10	13	110	97	65	0.3
	12-35	12	15	35	22	45	0.1
	12-55	12	15	55	42	49.5	0.2
	12-80	12	15	80	67	65	0.2
	12-110	12	15	110	97	65	0.3

• H: Insertion depth of tool • Not able to use the adjust screw • Through coolant system installed

(mm)

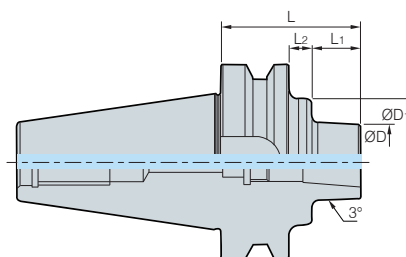
Designation	ØD	ØD ₁	L	M	H	G		
CM12	6-35	6	12	35	22	55	M5	0.2
	6-80	6	12	80	67	100	M5	0.2
	8-35	8	14	35	22	55	M5	0.2
	8-55	8	14	55	42	75	M5	0.2
	8-80	8	14	80	67	100	M5	0.3
	10-35	10	16	35	22	45	M8	0.2
	10-55	10	16	55	42	45	M8	0.2
	10-80	10	16	80	67	45	M8	0.3
	12-35	12	20	35	22	45	M8	0.2
	12-55	12	20	55	42	45	M8	0.3
	12-80	12	20	80	52	55	M8	0.3

• H: Insertion depth of tool • Not able to use the adjust screw • Through coolant system installed




BT-SLK

2-pieces type




(mm)

Designation		ØD	ØD ₁	L	L ₁	L ₂	 kg
BT30 -	SLK12-35	38	-	35	13	-	0.4
	SLK12-45F	41	-	45	18	-	1.0
	SLK12-75F	41	-	75	48	-	1.3
	SLK12-135F	41	-	135	108	-	2.1
BT50 -	SLK12-75	38	65	75	25	12	4.1
	SLK12-75F	41	65	75	25	12	4.1
	SLK12-105F	41	65	105	55	12	4.5
	SLK12-135F	41	65	135	85	12	5.3
	SLK12-225	38	65	225	150	37	6.2
	SLK12-315	38	90	315	150	127	11.5

• Through coolant system installed • PULL STUD BOLT is needed for BT30-SLK12-35

Parts

		Basic									
Type		DSC6	DSC8	DSC10	DSC12	DSC14	DSC16	DSC18	DSC20	DSC25	DSC32
Adjust screw		M520C		M820C				M1230C			



New power milling chuck

NPM

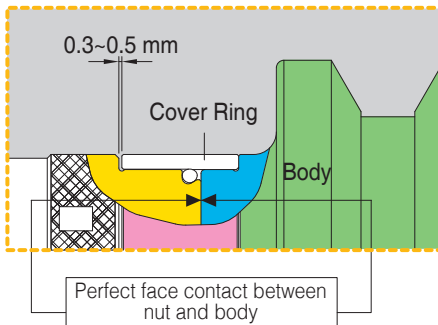
- Strong clamping over 500kgf·m (on NPM42 basis)
- DUST BLOCK functions for blocking foreign substance
- Jet coolant available
- High precision within 15 μm at L/D = 3
- Boring range: Ø20~42



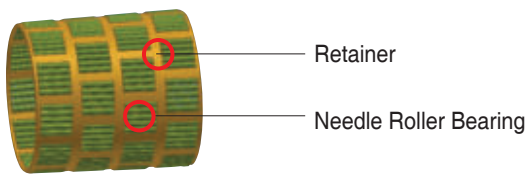
Code system



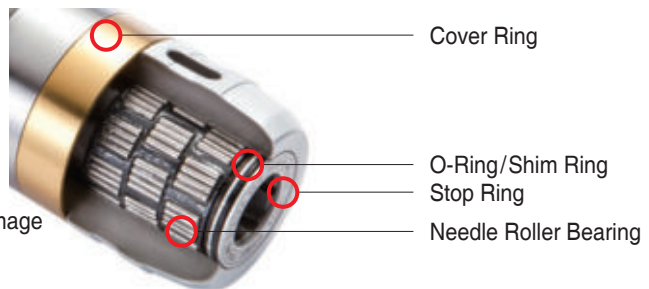
Improvement of durability by preventing minute dust, chips and coolant



- Adopted Stop Ring on Head parts
- Preventing minute dust by Shim & O-Ring



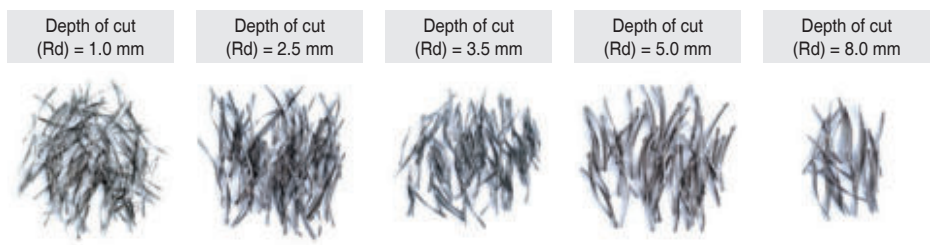
- Specially designed Steel Bearing for prevention of damage
- Strong clamping by spreading the force



Needle Roller Bearing

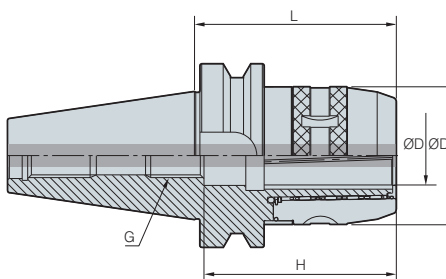
Stable machining from heavy to fine

Perfect face contact and Powerful clamping force strengthen both Cutting force and Absorbtion of vibration.




Possible machining from heavy milling to fine finishing

BT-NPM



(mm)




Designation	ØD	ØD ₁	L	H	G	Collet	
BT30 - NPM20-85	20	54	85	85	M16	DC20, DCS20, DCJ20	1.2
BT40 -	NPM20-85	20	54	85	M16	DC20, DCS20, DCJ20	2.6
	NPM20-100	20	54	100	M16	DC20, DCS20, DCJ20	2.3
	NPM25-85	25	61	85	M16	DC25	1.7
	NPM32-90	32	75	90	M16	DC32, DCS32, DCJ32	2.3
	NPM32-110	32	75	110	M16	DC32, DCS32, DCJ32	2.8
	NPM32-135	32	75	135	M16	DC32, DCS32, DCJ32	3.5
BT50 -	NPM20-95	20	54	95	M16	DC20, DCS20, DCJ20	4.3
	NPM20-125	20	54	125	M16	DC20, DCS20, DCJ20	4.7
	NPM20-165	20	54	165	M16	DC20, DCS20, DCJ20	5.2
	NPM32-110	32	75	110	M24	DC32, DCS32, DCJ32	5.0
	NPM32-135	32	75	135	M24	DC32, DCS32, DCJ32	5.7
	NPM32-165	32	75	165	M24	DC32, DCS32, DCJ32	6.9
	NPM42-110	42	90	110	M24	DC42, DCS42	5.4
	NPM42-135	42	90	135	M24	DC42, DCS42	6.5
NPM42-165	42	90	165	M24	DC42, DCS42	7.9	

 Applicable collet **G23**

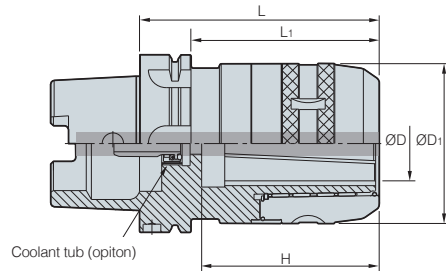
• H: Insertion depth of tool • Through coolant system is optional

• In case of L ≤ 90, chucks with over 90mm are recommended for medium cutting by short cap


Parts

For separate purchase			
Division	Collet	Spanner	Through coolant system
Parts			
Designation			
NPM20	DC20, DCS20, DCJ20	57-60	CTC20-□□
NPM32	DC32, DCS32, DCJ20	75-79	CTC32-□□
NPM42	DC42, DCS42	92-96	CTC42-□□

HSK-NPM




(mm)

Designation	ØD	ØD ₁	L	L ₁	H	Collet	
HSK63A - NPM20-100	20	54	100	74	75	DC20, DSC20, DCJ20	2.5
	NPM32-120	32	75	120	84	DC32, DCS32, DCJ32	2.9
HSK100A - NPM32-130	32	75	130	101	90	DC32, DCS32, DCJ32	4.0

 Spare Part **G21, G22**  Applicable collet **G23**

• H: Insertion depth of tool • Through coolant system is optional

Parts

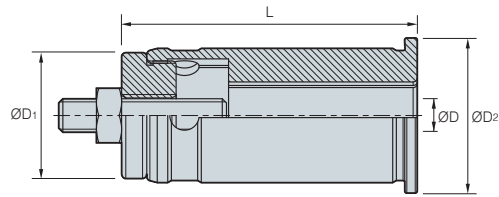
Division	For separate purchase
Internal coolant system	

Classification by shank	
HSK50	HSK50A-CNS
HSK63	HSK63A-CNS
HSK100	HSK100A-CNS



DCS

Straight Collet

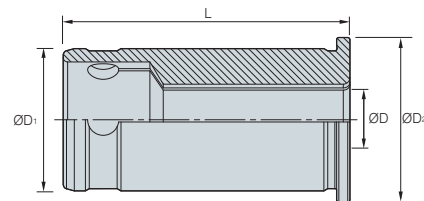


(mm)

Designation	ØD	ØD ₁	ØD ₂	L	/ kg
DCS20-6, 8, 10, 12, 16	6, 8, 10, 12, 16	20	26	55	0.2
DCS32-6, 8, 10, 12, 14, 16, 19, 20, 25	6, 8, 10, 12, 14, 16, 19, 20, 25	32	38	70	0.4
DCS42-6, 8, 10, 12, 16, 20, 25, 32	6, 8, 10, 12, 16, 20, 25, 32	42	48	75	0.7

DC

Straight Collet

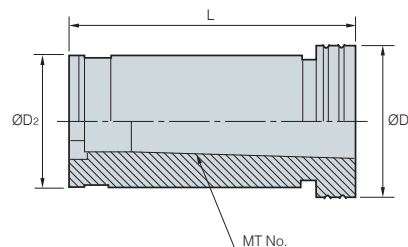


(mm)

Designation	ØD	ØD ₁	ØD ₂	L	/ kg
DC20-6, 8, 10, 12, 14, 16	6, 8, 10, 12, 14, 16	20	26	53	0.1
DC25-6, 8, 10, 12, 16	6, 8, 10, 12, 16	25	29	61.5	0.2
DC32-6, 8, 10, 12, 14, 16, 19, 20, 25	6, 8, 10, 12, 14, 16, 19, 20, 25	32	38	64.5	0.2
DC42-6, 8, 10, 12, 16, 20, 25, 32	6, 8, 10, 12, 16, 20, 25, 32	42	48	73	0.5

TC

Taper Collet



(mm)

Designation	ØD	ØD ₁	L	MT No.	Designation	ØD	ØD ₁	L	MT No.
TC20-1	26	20	60	MT1	TC32-3	38	32	90	MT3
TC20-2	26	20	72	MT2	TC42-1	48	42	60	MT1
TC25-1	32	25	60	MT1	TC42-2	48	42	72	MT2
TC25-2	32	25	72	MT2	TC42-3	48	42	90	MT3
TC32-1	38	32	60	MT1	TC42-4	48	42	112.5	MT4
TC32-2	38	32	72	MT2					

G Collet Chuck Series

Collet chuck

SDC/P

- Improved precision (higher than conventional SDC)
- Simpler model number management than conventional SDC due to its organized gauge line
- Collet chuck suitable for multi-purpose machining with SWISSMADE sleeve nut adopted
- Boring range: $\varnothing 1 \sim \varnothing 25$

Best functional nut (SWISS Made)



General R/RU Nut
Before




Soft sleeve bearing RN Nut
After



High speed collet chuck

DSK

- Available for machining at max.15,000 RPM and balancing of G6.3
- Minimized tool vibration during operation by using collet 8°
- Swiss made high precision nut enhances stability
- Tool clamping range: $\varnothing 2 \sim 25$

Standard type & Precision type	Designation	Max chucking	Run-out
	HC6- $\varnothing d$	6.0	Standard type 5 μm
	HC10- $\varnothing d$	10.0	
	HC13- $\varnothing d$	13.0	Precision type 3 μm
	HC16- $\varnothing d$	16.0	
	HC20- $\varnothing d$	20.0	
	HC25- $\varnothing d$	25.0	



8° HC collet



Minimized tool vibration during operation

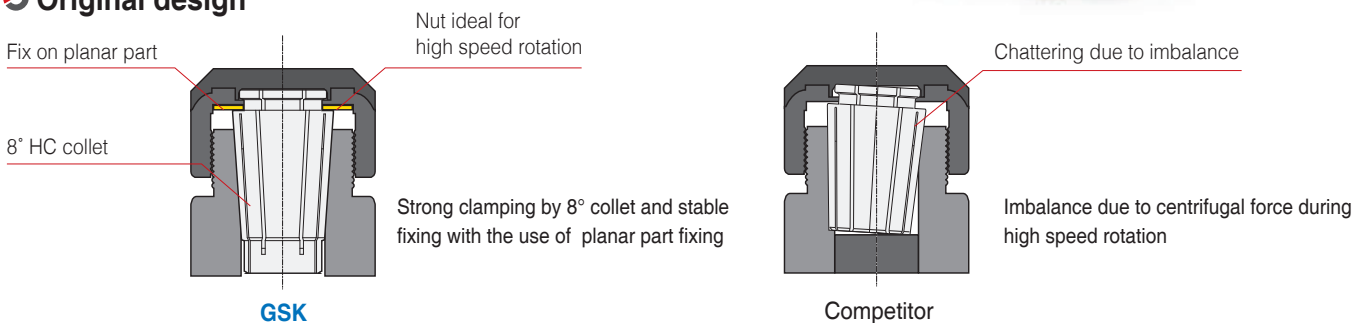
Great speed slim collet chuck

GSK

- Available for machining at max.25,000 RPM and balancing of G6.3
- Increased productivity due to high speed machining
- Minimized tool vibration during operation by using collet 8°
- Swiss made high precision nut enhances stability by pressing collet uniformly
- Tool clamping range: $\varnothing 2 \sim 25$



Original design



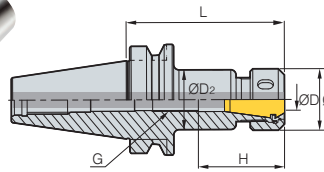
BT-SDC/P

Fig. 1

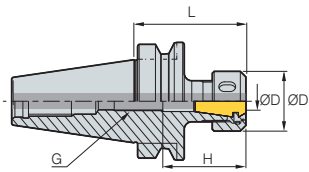


Fig. 2

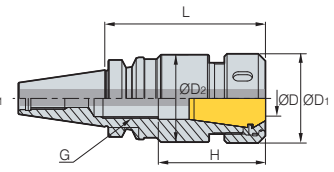


Fig. 3

(mm)

Designation	ØD	ØD ₁	ØD ₂	L	H	Collet	G	$\frac{G}{kg}$	Fig.	
BT30 -	SDC7P-70	1.0~7.0	18	17	70	33	GERC11	M7	0.5	1
	SDC7P-100	1.0~7.0	18	17	100	33	GERC11	M7	0.5	1
	SDC10P-50	1.0~10.0	32	-	50	44.5	GERC16	M10	0.5	2
	SDC10P-70	1.0~10.0	32	31	70	44.5	GERC16	M10	0.6	1
	SDC10P-100	1.0~10.0	32	31	100	44.5	GERC16	M10	0.7	1
	SDC13P-50	1.0~13.0	35	-	50	49	GERC20	M7	0.5	2
	SDC13P-70	1.0~13.0	35	34	70	49	GERC20	M13	0.6	1
	SDC13P-100	1.0~13.0	35	34	100	49	GERC20	M13	0.8	1
	SDC16P-50	2.0~16.0	42	-	50	50	GERC25	M7	0.5	2
	SDC16P-70	2.0~16.0	42	41	70	50	GERC25	M18	0.7	1
	SDC16P-100	2.0~16.0	42	41	100	50	GERC25	M18	1.0	1
	SDC20P-60	2.0~20.0	50	-	60	60	GERC32	M7	0.6	2
	SDC20P-90	2.0~20.0	50	49	90	60	GERC32	M22	1.0	3
	SDC20P-120	2.0~20.0	50	49	120	60	GERC32	M22	1.4	3
BT40 -	SDC7P-70	1.0~7.0	18	17	70	33	GERC11	M7	0.9	1
	SDC7P-90	1.0~7.0	18	17	90	33	GERC11	M7	0.9	1
	SDC7P-130	1.0~7.0	18	17	130	33	GERC11	M7	1.0	1
	SDC10P-70	1.0~10.0	32	31	70	44.5	GERC16	M10	1.0	1
	SDC10P-90	1.0~10.0	32	31	90	44.5	GERC16	M10	1.2	1
	SDC10P-130	1.0~10.0	32	31	130	44.5	GERC16	M10	1.4	1
	SDC13P-70	1.0~13.0	35	34	70	49	GERC20	M13	1.1	1
	SDC13P-90	1.0~13.0	35	34	90	49	GERC20	M13	1.2	1
	SDC13P-130	1.0~13.0	35	34	130	49	GERC20	M13	1.4	1
	SDC13P-150	1.0~13.0	35	34	150	49	GERC20	M13	1.6	1
	SDC16P-70	2.0~16.0	42	41	70	50	GERC25	M18	1.1	1
	SDC16P-90	2.0~16.0	42	41	90	50	GERC25	M18	1.3	1
	SDC16P-130	2.0~16.0	42	41	130	50	GERC25	M18	1.7	1
	SDC20P-70	2.0~20.0	50	-	70	60	GERC32	M22	1.1	2
	SDC20P-90	2.0~20.0	50	49	90	60	GERC32	M22	1.4	1
	SDC20P-130	2.0~20.0	50	49	130	60	GERC32	M22	1.9	1
	SDC20P-150	2.0~20.0	50	49	150	60	GERC32	M22	2.2	1
	SDC26P-90	16.0~26.0	63	62	90	71	GERC40	M28	1.7	1

➔ Spare Part **G26** ➔ Applicable collet **G33**

• H: Insertion depth of tool • Through coolant system is optional
• Collets in the right size are recommended for oil hole type

BT-SDC/P

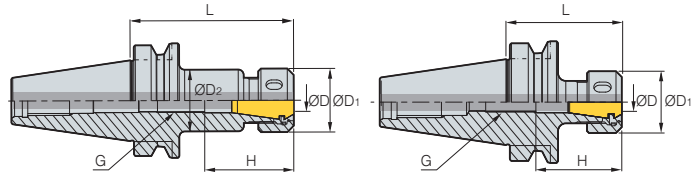



Fig. 1

Fig. 2





(mm)

Designation	ØD	ØD ₁	ØD ₂	L	H	Collet	G	 kg	Fig.	
BT50 -	SDC10P-100	1.0~10.0	32	31	100	44.5	GERC16	M10	3.7	1
	SDC10P-120	1.0~10.0	32	31	120	44.5	GERC16	M10	3.7	1
	SDC10P-160	1.0~10.0	32	31	160	44.5	GERC16	M10	3.8	1
	SDC13P-100	1.0~13.0	35	34	100	49	GERC20	M13	3.8	1
	SDC13P-130	1.0~13.0	35	34	130	49	GERC20	M13	3.8	1
	SDC13P-160	1.0~13.0	35	34	160	49	GERC20	M13	4.1	1
	SDC13P-180	1.0~13.0	35	34	180	49	GERC20	M13	4.2	1
	SDC16P-100	2.0~16.0	42	41	100	50	GERC25	M18	3.9	1
	SDC16P-160	2.0~16.0	42	41	160	50	GERC25	M18	4.3	1
	SDC20P-70	2.0~20.0	50	-	70	60	GERC32	M22	1.7	2
	SDC20P-100	2.0~20.0	50	49	100	60	GERC32	M22	4.0	1
	SDC20P-130	2.0~20.0	50	49	130	60	GERC32	M22	4.3	1
	SDC20P-160	2.0~20.0	50	49	160	60	GERC32	M22	4.7	1
	SDC20P-180	2.0~20.0	50	49	180	60	GERC32	M22	5.0	1
SDC26P-160	16.0~26.0	63	62	160	71	GERC40	M28	5.5	1	

 Spare Part **G26**  Applicable collet **G33**

• H: Insertion depth of tool • Through coolant system is optional
• Collets in the right size are recommended for oil hole type

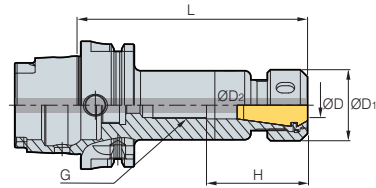
Parts

Division	Basic		For separate purchase	
	Sleeve bearing nut	Adjust screw	Spanner	Collet
Parts				
Designation				
SDC7P	RN11	BN0716F	20-22	GERC/ER 11-ØD
SDC10P	RN16	BN1025F	32-35	GERC/ER 16-ØD
SDC13P	RN20	BN1325F	35-38	GERC/ER 20-ØD
SDC16P	RN25	BN1830F	42-46	GERC/ER 25-ØD
SDC20P	RN32	BN2230F	48-52	GERC/ER 32-ØD
SDC26P	RN40	BN2838F	62-65	GERC/ER 40-ØD


* NOTES: In case of the BT30-SDC13P-50/HSK63A-SDC13P-100, a BN0716F screw



HSK-SDC/P




(mm)

Designation	ØD	ØD ₁	ØD ₂	L	H	Collet	G		
HSK63A -	SDC10P-100	1.0~10.0	32	31	100	44.5	GER16	M10	1.0
	SDC13P-100	1.0~13.0	35	34	100	49	GER20	M7	1.1
	SDC16P-100	1.0~16.0	42	41	100	50	GER25	M7	1.2
	SDC20P-110	1.0~20.0	50	49	110	60	GER32	M7	1.5
HSK100A -	SDC16P-110	1.0~16.0	42	41	110	50	GER25	M13	2.6
	SDC20P-120	2.0~20.0	50	49	120	60	GER32	M10	2.9

 Spare Part **G26, G27**  Applicable collet **G33**

• H: Insertion depth of tool • Through coolant system is optional
• Collets in the right size are recommended for oil hole type

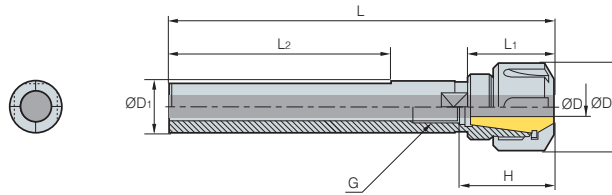
Parts

Division	For separate purchase
Internal coolant system	


Classification by shank	
HSK50	HSK50A-CNS
HSK63	HSK63A-CNS
HSK100	HSK100A-CNS




S-SDC



(mm)

Designation	ØD	ØD ₁	ØD ₂	L	L ₁	L ₂	H	Collet	G		
S16 -	SDC7-120M	1.0~7.0	19	16	120	-	-	33	GERC11	M7	0.1
	SDC7-120T	1.0~7.0	19	16	120	-	73	33	GERC11	M7	0.1
	SDC10-150T	1.0~10.0	28	16	150	46.5	83	34.5	GERC16	M10	0.2
S20 -	SDC10-150M	1.0~10.0	28	20	150	26.5	-	34.5	GERC16	M10	0.3
	SDC10-150T	1.0~10.0	28	20	150	26.5	83	34.5	GERC16	M10	0.3
	SDC13-150M	1.0~13.0	35	20	150	50	-	49	GERC20	M13	0.3
	SDC13-150T	1.0~13.0	35	20	150	50	83	49	GERC20	M13	0.3
S25 -	SDC10-150M	1.0~10.0	28	25	150	-	-	34.5	GERC16	M10	0.4
	SDC10-150T	1.0~10.0	28	25	150	-	83	34.5	GERC16	M10	0.4
	SDC13-150M	1.0~13.0	35	25	150	-	-	49	GERC20	M13	0.4
	SDC13-150T	1.0~13.0	35	25	150	-	83	49	GERC20	M13	0.4
S32 -	SDC13-150M	1.0~13.0	35	32	150	-	-	49	GERC20	M13	0.7
	SDC13-150T	1.0~13.0	35	32	150	-	83	49	GERC20	M13	0.7
	SDC20-165M	2.0~20.0	50	32	165	-	-	60	GERC32	M22	0.9
	SDC20-165T	2.0~20.0	50	32	165	-	83	60	GERC32	M22	0.9

 Applicable collet **G33**

• H: Insertion depth of tool • Through coolant system is optional



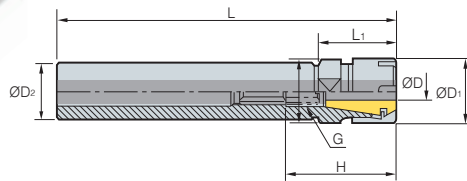
S-SDC/S

Fig. 1

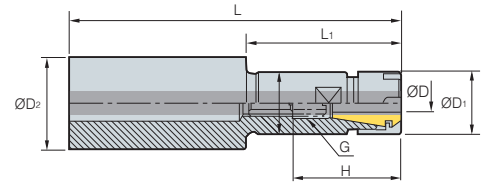




Fig. 2

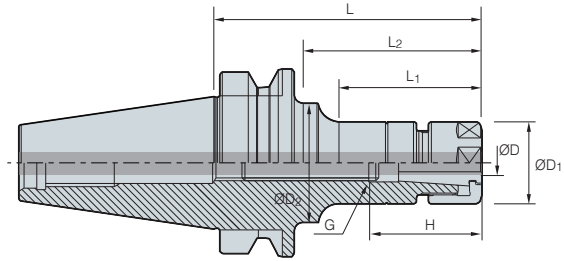
Designation		ØD	ØD ₁	ØD ₂	L	L ₁	H	Collet/Step	G	
S16 -	SDC7S-100M	1.0~7.0	16	16	100	21	33	GERC11/0.5	M7	0.1
	SDC7S-150M	1.0~7.0	16	16	150	21	33	GERC11/0.5	M7	0.1
	SDC10S-100M	1.0~10.0	22	16	100	50	44.5	GERC16/1.0	M10	0.1
	SDC10S-150M	1.0~10.0	22	16	150	50	44.5	GERC16/1.0	M10	0.1
S20 -	SDC7S-100M	1.0~7.0	16	20	100	30	35	GERC11/0.5	M7	0.1
	SDC7S-150M	1.0~7.0	16	20	150	80	35	GERC11/0.5	M7	0.2
	SDC10S-100M	1.0~10.0	22	20	100	50	44.5	GERC16/1.0	M10	0.1
	SDC10S-150M	1.0~10.0	22	20	150	50	44.5	GERC16/1.0	M10	0.2
	SDC10S-200M	1.0~10.0	22	20	200	50	44.5	GERC16/1.0	M10	0.3
	SDC13S-100M	1.0~13.0	28	20	100	50	49	GERC20/1.0	M13	0.1
	SDC13S-150M	1.0~13.0	28	20	150	50	49	GERC20/1.0	M13	0.2
S25 -	SDC7S-100M	1.0~7.0	16	25	100	30	33	GERC11/0.5	M7	0.2
	SDC7S-150M	1.0~7.0	16	25	150	80	33	GERC11/0.5	M7	0.2
	SDC10S-100M	1.0~10.0	22	25	100	30	44.5	GERC16/1.0	M10	0.2
	SDC10S-150M	1.0~10.0	22	25	150	80	44.5	GERC16/1.0	M10	0.3
	SDC13S-100M	1.0~13.0	28	25	100	50	49	GERC20/1.0	M13	0.2
	SDC13S-150M	1.0~13.0	28	25	150	50	49	GERC20/1.0	M13	0.4
	SDC16S-100M	1.0~16.0	35	25	100	50	50	GERC25/1.0	M18	0.3
	SDC16S-150M	1.0~16.0	35	25	150	50	50	GERC25/1.0	M18	0.4
S32 -	SDC16S-120M	1.0~16.0	35	32	120	50	50	GERC25/1.0	M18	0.5
	SDC16S-150M	1.0~16.0	35	32	150	50	50	GERC25/1.0	M18	0.6

(mm)


 Applicable collet **G33**

• H: Insertion depth of tool • Through coolant system is optional

BT-DSK



(mm)

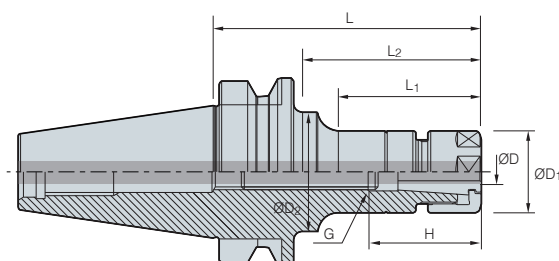
Designation	ØD	ØD ₁	ØD ₂	L	L ₁	L ₂	H	Collet	G	RPM		
BT30 -	DSK6-60	3.0~6.0	19.5	19.5	60	33	33	31	HC6	M8	15,000	0.4
	DSK6-90	3.0~6.0	19.5	32	90	56	65	31	HC6	M8	15,000	0.5
	DSK10-60	2.0~10.0	27.5	27.5	60	35	35	38	HC10	M12	15,000	0.5
	DSK10-90	2.0~10.0	27.5	27.5	90	65	65	38	HC10	M12	15,000	0.6
	DSK13-60	3.0~13.0	33	33	60	36	36	43	HC13	M12	15,000	0.5
	DSK16-60	3.0~16.0	40	40	60	37	37	52	HC16	M12	15,000	0.6
	DSK16-90	3.0~16.0	40	40	90	67	67	52	HC16	M18	15,000	0.8
	DSK25-90	16.0~25.0	55	55	90	67.5	67.5	63.5	HC25	M12	15,000	0.9
BT40 -	DSK6-90	3.0~6.0	19.5	32	90	51	61	31	HC6	M8	10,000	1.1
	DSK6-120	3.0~6.0	19.5	32	120	60	90	31	HC6	M8	10,000	1.1
	DSK6-150	3.0~6.0	19.5	25	150	60	120	31	HC6	M8	10,000	1.1
	DSK10-90	2.0~10.0	27.5	40	90	48	60	38	HC10	M12	10,000	1.2
	DSK10-120	2.0~10.0	27.5	40	120	73	90	38	HC10	M12	10,000	1.2
	DSK10-150	2.0~10.0	27.5	34.5	150	73	118	38	HC10	M12	10,000	1.4
	DSK13-90	3.0~13.0	33	33	90	59	59	43	HC13	M15	10,000	1.3
	DSK16-90	3.0~16.0	40	40	90	58	58	52	HC16	M18	10,000	1.3
	DSK16-120	3.0~16.0	40	40	120	88	88	52	HC16	M18	10,000	1.5
	DSK16-150	3.0~16.0	40	40	150	118	118	52	HC16	M18	10,000	1.9
	DSK20-90	4.0~20.0	48.5	48.5	90	60	60	60	HC20	M22	10,000	1.5
	DSK20-120	4.0~20.0	48.5	48.5	120	90	90	60	HC20	M22	10,000	1.8
	DSK25-90	16.0~25.0	55	55	90	61	61	63.5	HC25	M28	10,000	1.6
	DSK25-120	16.0~25.0	55	55	120	91	91	85	HC25	M28	10,000	2.0

 Spare Part **G31**  Applicable collet **G33**

- H: Insertion depth of tool
- Through coolant system is optional
- Coolant collets are recommended when using the coolant system



BT-DSK



(mm)

Designation	ØD	ØD ₁	ØD ₂	L	L ₁	L ₂	H	Collet	G	RPM	kg	
BT50 -	DSK6-105	3.0~6.0	19.5	32	105	55	64	31	HC6	M8	8,000	3.6
	DSK6-135	3.0~6.0	19.5	32	135	60	92	31	HC6	M8	8,000	3.7
	DSK6-165	3.0~6.0	19.5	32	165	60	114	31	HC6	M8	8,000	4.1
	DSK10-105	2.0~10.0	27.5	27.5	105	57	57	38	HC10	M12	8,000	3.8
	DSK10-135	2.0~10.0	27.5	32	135	70	92	38	HC10	M12	8,000	3.9
	DSK10-165	2.0~10.0	27.5	36	165	75	114	38	HC10	M12	8,000	4.1
	DSK13-135	3.0~13.0	33	33	135	92	92	43	HC13	M15	8,000	3.8
	DSK16-105	3.0~16.0	40	40	105	62	62	52	HC16	M18	8,000	4.0
	DSK16-135	3.0~16.0	40	40	135	92	92	52	HC16	M18	8,000	4.2
	DSK16-165	3.0~16.0	40	50	165	40	122	52	HC16	M18	8,000	4.6
	DSK20-105	4.0~20.0	48	40	105	62	62	60	HC20	M22	8,000	4.2
	DSK20-135	4.0~20.0	48	40	135	92	92	60	HC20	M22	8,000	4.5
	DSK20-165	4.0~20.0	48	40	165	122	122	60	HC20	M22	8,000	4.9
	DSK25-105	16.0~25.0	55	55	105	62	62	63.5	HC25	M28	8,000	4.4
	DSK25-135	16.0~25.0	55	55	135	92	92	63.5	HC25	M28	8,000	4.5
DSK25-165	16.0~25.0	55	55	165	122	122	63.5	HC25	M28	8,000	5.2	

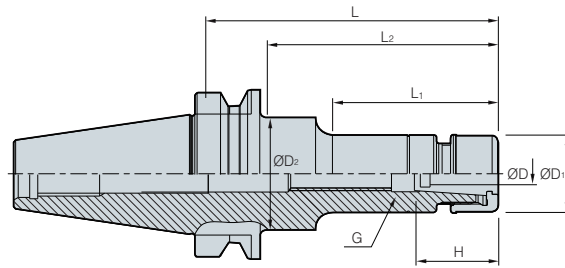
Applicable collet **G33**

- H: Insertion depth of tool
- Through coolant system is optional
- Coolant collets are recommended when using the coolant system

Parts

Division	Basic			For separate purchase
	Nut	Adjust screw	Extractor	Spanner
Parts				
Designation				
DSK6	DN6	BN0825F	DSK-6CE	DSS-6
DSK10	DN10	BN1225F	DSK-10CE	DSS-10
DSK13	DN13	BN1230 (BT30)/BN1524F (Others)	DSK-13CE	DSS-13
DSK16	DN16	BN1830F	DSK-16CE	DSS-16
DSK20	DN20	BN2230F	DSK-20CE	DSS-20
DSK25	DN25	BN2838F	DSK-25CE	DSS-25

BT-GSK



(mm)

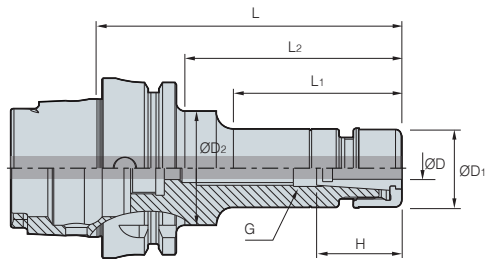
Designation	ØD	ØD ₁	ØD ₂	L	L ₁	L ₂	H	Collet/ Step	G	RPM	$\frac{kg}{kg}$	
BT30 -	GSK6-60	3.0~6.0	19.5	19.5	60	33	33	31	HC6/1.0	M8	25,000	0.4
	GSK6-90	3.0~6.0	19.5	32	90	56	65	31	HC6/1.0	M8	25,000	0.5
	GSK10-60	2.0~10.0	27	27	60	35	35	38	HC10/1.0	M12	25,000	0.5
	GSK10-90	2.0~10.0	27	27	90	65	65	38	HC10/1.0	M12	25,000	0.6
	GSK13-60	3.0~13.0	35	35	60	36	36	43	HC13/1.0	M12	25,000	0.6
	GSK16-60	3.0~16.0	40	40	60	37	37	52	HC16/1.0	M12	25,000	0.6
	GSK16-90	3.0~16.0	40	40	90	67	67	52	HC16/1.0	M18	25,000	0.8
	GSK25-90	16.0~25.0	55	55	90	67.5	67.5	63.5	HC25/1.0	M12	25,000	1.0
BT40 -	GSK6-90	3.0~6.0	19.5	32	90	51	61	31	HC6/1.0	M8	20,000	1.0
	GSK6-120	3.0~6.0	19.5	32	120	60	90	31	HC6/1.0	M8	20,000	1.2
	GSK6-150	3.0~6.0	19.5	25	150	60	120	31	HC6/1.0	M8	20,000	1.2
	GSK10-90	2.0~10.0	27	40	90	48	60	38	HC10/1.0	M12	20,000	1.1
	GSK10-120	2.0~10.0	27	40	120	73	90	38	HC10/1.0	M12	20,000	1.3
	GSK10-150	2.0~10.0	27	34.5	150	73	118	38	HC10/1.0	M12	20,000	1.4
	GSK13-90	3.0~13.0	35	35	90	59	59	43	HC13/1.0	M15	20,000	1.2
	GSK16-90	3.0~16.0	40	40	90	58	58	52	HC16/1.0	M18	20,000	1.3
	GSK16-120	3.0~16.0	40	40	120	88	88	52	HC16/1.0	M18	20,000	1.5
	GSK16-150	3.0~16.0	40	40	150	118	118	52	HC16/1.0	M18	20,000	1.8
	GSK20-90	4.0~20.0	48	48	90	60	60	60	HC20/1.0	M22	20,000	1.4
	GSK20-120	4.0~20.0	48	48	120	90	90	60	HC20/1.0	M22	20,000	1.8
	GSK25-90	16.0~25.0	55	55	90	61	61	63.5	HC25/1.0	M28	20,000	1.6
GSK25-120	16.0~25.0	55	55	120	91	91	63.5	HC25/1.0	M28	20,000	2.0	
BT50 -	GSK6-105	3.0~6.0	19.5	32	105	55	64	31	HC6	M8	15,000	3.6
	GSK6-135	3.0~6.0	19.5	32	135	60	92	31	HC6	M8	15,000	3.6
	GSK6-165	3.0~6.0	19.5	32	165	60	114	31	HC6	M8	15,000	3.9
	GSK10-105	2.0~10.0	27	27	105	57	57	38	HC10	M12	15,000	3.7
	GSK10-135	2.0~10.0	27	32	135	70	92	38	HC10	M12	15,000	3.7
	GSK10-165	2.0~10.0	27	36	165	75	114	38	HC10	M12	15,000	4.0
	GSK13-135	3.0~13.0	35	35	135	92	92	43	HC13	M15	15,000	3.9
	GSK16-105	3.0~16.0	40	40	105	62	62	52	HC16	M18	15,000	3.9
	GSK16-135	3.0~16.0	40	40	135	92	92	52	HC16	M18	15,000	4.1
	GSK16-165	3.0~16.0	40	50	165	40	122	52	HC16	M18	15,000	4.3
	GSK20-105	4.0~20.0	48	-	105	62	62	60	HC20	M22	15,000	4.1
	GSK20-135	4.0~20.0	48	-	135	92	92	60	HC20	M22	15,000	4.4
	GSK20-165	4.0~20.0	48	-	165	122	122	60	HC20	M22	15,000	4.9
	GSK25-105	16.0~25.0	55	55	105	62	62	63.5	HC25	M28	15,000	4.2
	GSK25-135	16.0~25.0	55	55	135	92	92	63.5	HC25	M28	15,000	4.6
GSK25-165	16.0~25.0	55	55	165	122	122	63.5	HC25	M28	15,000	5.1	

↻ Spare Part **G33** ↻ Applicable collet **G33**


- H: Insertion depth of tool
- Through coolant system is optional
- Coolant collets are recommended when using the coolant system



HSK-GSK







(mm)

Designation	ØD	ØD ₁	ØD ₂	L	L ₁	L ₂	H	Collet / Step	G	RPM		
HSK63A -	GSK6-100	3.0~6.0	19.5	32	100	51	61	35	HC6/0.5	M8	20,000	0.8
	GSK10-105	2.0~10.0	27	34.5	105	73	118	50	HC10/0.5	M12	20,000	0.9
	GSK16-120	3.0~16.0	40	40	120	58	58	60	HC16/0.5	M18	20,000	1.3
	GSK20-120	4.0~20.0	48	48	120	60	60	70	HC20/0.5	M22	20,000	1.6
HSK100A -	GSK6-120	3.0~6.0	19.5	32	120	55	64	35	HC6/0.5	M8	15,000	2.2
	GSK10-120	2.0~10.0	27	27	120	57	57	50	HC10/0.5	M12	15,000	2.3
	GSK16-140	3.0~16.0	40	40	140	62	62	60	HC16/0.5	M18	15,000	2.8
	GSK25-155	16.0~25.0	55	55	155	62	62	85	HC25/0.5	M28	15,000	3.6

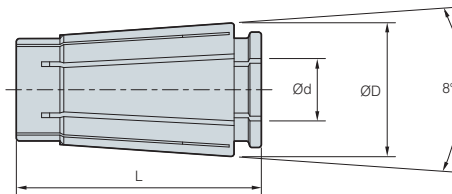
• H: Insertion depth of tool

Parts

Basic				For separate purchase
Division	Nut	Adjust screw	Extractor	Spanner
Parts				
Designation				
GSK6	GN6	M820C	DSK-6CE	GSK-6
GSK10	GN10	M1230C	DSK-10CE	GSK-10
GSK13	GN13	BN1530F	DSK-13CE	GSK-13
GSK16	GN16	BN1830F	DSK-16CE	GSK-16
GSK20	GN20	BN2230F	DSK-20CE	GSK-20
GSK25	GN25	BN2838F	DSK-25CE	GSK-25

HC Slim Collet

General & precision type



(mm)

Designation	ØD	L	Ød (Max.)	Distance (mm)	Tolerance	
					Standard type	Precision type (P)
HC6 - Ød(P)	10.5	25.0	6.0	1.0	5 µm	3 µm
HC10 - Ød(P)	15.6	30.5	10.0	1.0		
HC13 - Ød(P)	20.1	39.0	13.0	1.0		
HC16 - Ød(P)	24.6	45.0	16.0	1.0		
HC20 - Ød(P)	29.2	54.3	20.0	2.0		
HC25 - Ød(P)	35.7	57.0	25.0	1.0		



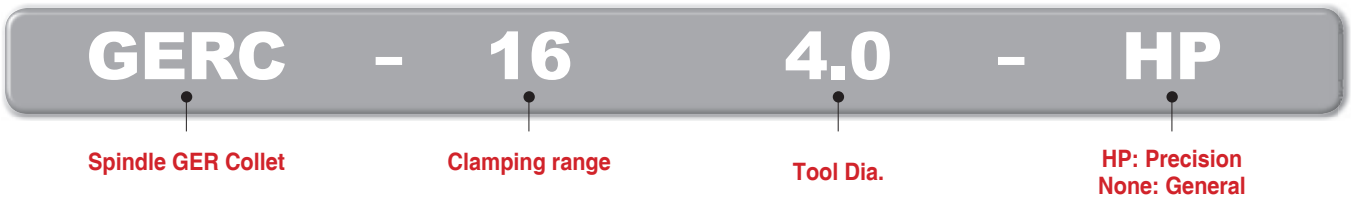
GERC Collet

GERC new

- Corrosion resistant collet to micro unit
- High tech coating for long lasting precision
- Longer tool life and higher productivity

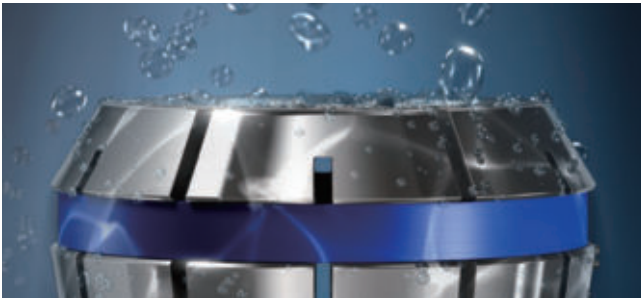


Code system

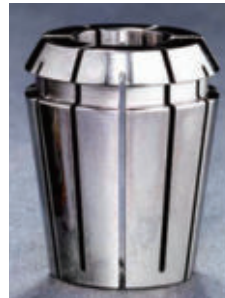


Special coating technology

Unlike GERC collets, Conventional non-coated collets have the following features:
 Non-coated collets are affected by corrosion due to high humidity, cutting fluid, cleaner, salt, gas and many other factors, which in result deteriorates whole quality of machining



When a collet gets rusty, the tool life is shortened and precision considerably decreases. To prevent this problem, surface treatment by micro unit was applied to GERC collets for effective protection and long lasting precision



GERC



Competitor

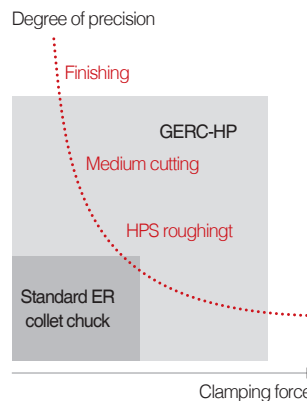
Two samples of collets after 4 months of use:
 Left: GERC collet, Right: Non-coated

GERC-HP

A precision type collet chuck is expensive than standard one, but still it has more advantages in long term cost and efficiency. Using GERC-HP can minimize pricy reworking due to smaller tolerance with maximum precision

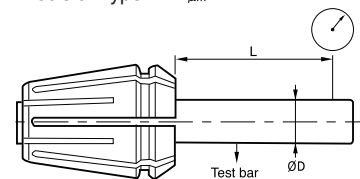


Precision type collet 2 μ m



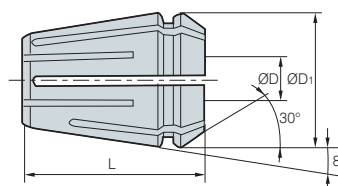
Precision (L/D = 3)

Standard type = 5 μ m
 Precision type = 2 μ m



GERC Collet

General/Precision/Water proof type



(mm)


Designation	ER size	ØD (Max.)	ØD ₁	L	Min. pi of water proof type	Distance (mm)	Tolerance	
							Standard type	Precision type (HP)
GER11-Ød(HP)	11	7.0	11.5	18.0	-	0.5	5 µm	2 µm
GER16-Ød(HP, C)	16	10.0	17.0	27.5	5.0	1.0		
GER20-Ød(HP, C)	20	13.0	21.0	31.5	6.0	1.0		
GER25-Ød(HP, C)	25	16.0	26.0	34.0	6.0	1.0		
GER32-Ød(HP, C)	32	20.0	33.0	40.0	8.0	1.0		
GER40-Ød	40	26.0	41.0	46.0	10.0	1.0		

GERC Collet

General type



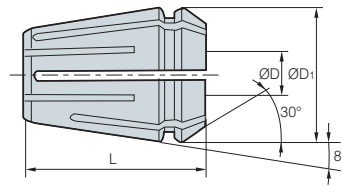
(mm)

Designation	ØD	Distance	Collet amount	Tolerance	
GERC11 1.0-7.0 mm/0.5 mm	1.0-7.0	0.5	13 pcs	5 µm	0.1
GERC16 1.0-10.0 mm/1.0 mm	1.0-10.0	1.0	10 pcs	5 µm	0.2
GERC20 2.0-13.0 mm/1.0 mm	2.0-13.0	1.0	12 pcs	5 µm	0.5
GERC25 2.0-16.0 mm/1.0 mm	2.0-16.0	1.0	15 pcs	5 µm	1.1
GERC32 3.0-20.0 mm/1.0 mm	3.0-20.0	1.0	18 pcs	5 µm	2.6
GERC40 4.0-26.0 mm/1.0 mm	4.0-26.0	1.0	23 pcs	5 µm	5.8



ER Collet

General/Water proof type



(mm)

Designation	ER size	ØD (Max.)	ØD ₁	L	Min. pi of water proof type	Distance (mm)	Tolerance
ER11-Ød	11	7.0	11.5	18.0	-	0.5	10 µm
ER16-Ød(C)	16	10.0	17.0	27.5	5.0	1.0	
ER20-Ød(C)	20	13.0	21.0	31.5	6.0	1.0	
ER25-Ød(C)	25	16.0	26.0	34.0	6.0	1.0	
ER32-Ød(C)	32	20.0	33.0	40.0	8.0	1.0	

ER Collet

General type



(mm)

Designation	ØD	Distance	Collet amount	Tolerance
ER11(SET)	1.0-7.0	0.5	12 pcs	10 µm
ER16(SET)	1.0-10.0	1.0	10 pcs	10 µm
ER20(SET)	2.0-13.0	1.0	12 pcs	10 µm
ER25(SET)	2.0-16.0	1.0	15 pcs	10 µm
ER32(SET)	3.0-20.0	1.0	18 pcs	10 µm



Lock collet for ER collet chuck

ER/L

- Designed to prevent the end mill from falling out
- Prevents tool fallout, slipping, or idle running
- Uses the Weldon flat (DIN 6535HB) end mill without any special endmill
- Useful for machining large-sized mold or difficult-to-cut materials



Structural Features

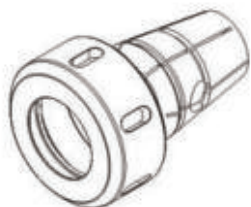
Designed to prevent fallout

- Tool fallout is prevented by a key inserted in the collet
- A key is inserted to prevent the tool from falling out

How to use

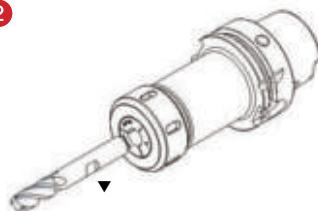
- Assemble the collet with nut (same for general ER collet in use)
- Assemble the end tool (in the direction of assembling notch with key)
- Tighten the nut with the body

1



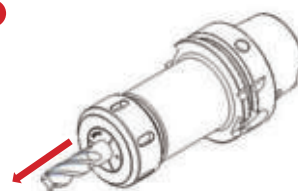
Combine the non-slip ER collet with nut

2



Clamp the nut after inserting no. 1 into the collet chuck. After that, insert the end mill notch to be aligned with the part ▼ (steel ball position)

3

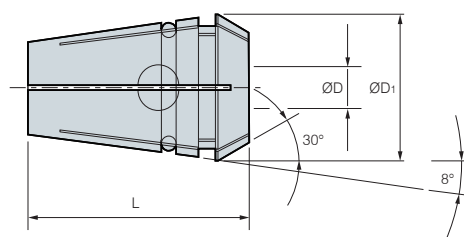


After checking that the steel ball in the collet is caught in the notched part, completely clamp the nut by pulling the end mill in the axial direction (arrow direction)

Note If an auto clamp device is used, skip step 3 (Endmill rotation may cause injury)

ER/L Collet

Non-slip collet chuck collet



(mm)

Designation	ØD	ØD	ØD ₁	L
ER20-6L	20	6	20.7	31.5
ER20-8L	20	8	20.7	31.5
ER20-10L	20	10	20.7	31.5
ER20-12L	20	12	20.7	31.5
ER32-12L	32	12	32.7	40
ER32-16L	32	16	32.7	40
ER32-20L	32	20	32.7	40



Jet coolant disk

RTJW

- Provides a longer cutting tool service life by preventing chips from adhering to the tool
- Improves chip breakability/breaking strong jet injection
- Reduces equipment non-operation time as nozzle position change is not necessary

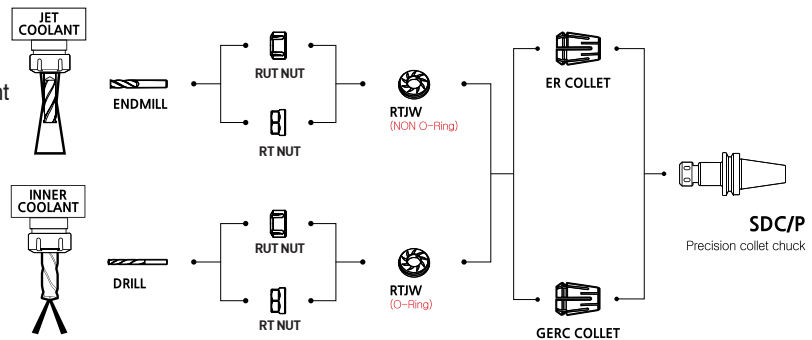


Code system



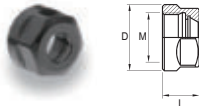
Application

- With one waterproof type (RT, RUT) NUT, the inside jet coolant is simultaneously used
- Enables a fast change of the inside jet coolant only by disk replacement
- Strong jet injection with no scattering even in the high-speed rotation



RT NUT

Type	M	D	L
RT16	M22x1.50	28.0	22.5

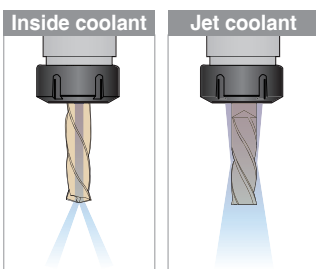


RUT NUT

Type	M	D	L
RUT20	M25x1.50	35.0	24.0
RUT25	M32x1.50	42.0	25.0
RUT32	M40x1.50	50.0	27.5
RUT40	M50x1.50	63.0	30.5

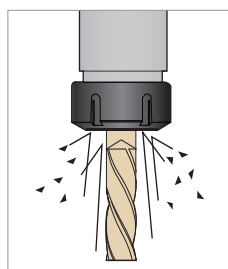


	Pocket machining	After	Remarks
Jet coolant			▶ The chips in the pocket completely are removed by a strong jet injection
Outside coolant			▶ The chips in the pocket are not removed ▶ Chips are accumulated in the collet and nut



Coolant method

According to use, inside coolant and jet coolant refueling can be used



Mixing prevention

Effective for vibration proof by preventing mixing of cutting chips by using RTJW

RTJW



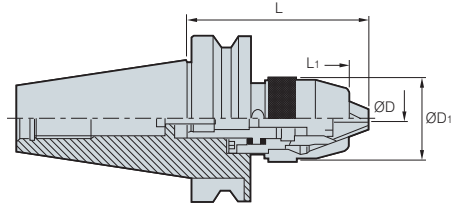
(mm)

Designation		ER size	Inner diameter	Designation		ER size	Inner diameter
RTJW16 -	RTJW16-6	16	6	RTJW32 -	RTJW32-6	32	6
	RTJW16-7	16	7		RTJW32-7	32	7
	RTJW16-8	16	8		RTJW32-8	32	8
RTJW20 -	RTJW20-6	20	6		RTJW32-9	32	9
	RTJW20-7	20	7		RTJW32-10	32	10
	RTJW20-8	20	8		RTJW32-11	32	11
	RTJW20-9	20	9		RTJW32-12	32	12
	RTJW20-10	20	10		RTJW32-13	32	13
RTJW25 -	RTJW25-6	25	6		RTJW32-14	32	14
	RTJW25-7	25	7		RTJW32-15	32	15
	RTJW25-8	25	8		RTJW32-16	32	16
	RTJW25-9	25	9		RTJW32-17	32	17
	RTJW25-10	25	10		RTJW32-18	32	18
	RTJW25-11	25	11	RTJW32-20	32	20	
	RTJW25-12	25	12	RTJW40 -	RTJW40-18	40	18
	RTJW25-13	25	13		RTJW40-19	40	19
	RTJW25-14	25	14		RTJW40-20	40	20
	RTJW25-15	25	15		RTJW40-21	40	21
RTJW25-16	25	16	RTJW40-22		40	22	
			RTJW40-24		40	24	


→ Clamping items: G25~G27

• Less than Ø5 cannot be used for production

BT-NPU

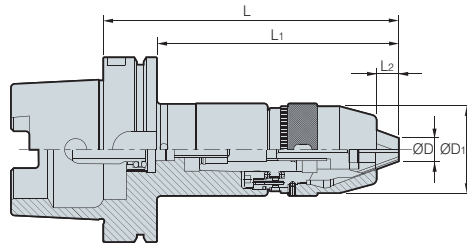


(mm)


Designation		ØD	ØD ₁	L	L ₁	
BT30 -	NPU8-97	1~ 8	38	97	8.5	0.8
	NPU13-125	1~13	50	125	12.5	1.4
BT40 -	NPU8-87	1~ 8	38	87	8.5	1.2
	NPU13-105	1~13	50	105	12.5	1.6
	NPU13-130	1~13	50	130	12.5	1.9
BT50 -	NPU13-130	1~13	50	130	12.5	4.5
	NPU13-190	1~13	50	190	12.5	5.3

• Through coolant system not available

HSK-NPU






(mm)

Designation		ØD	ØD ₁	L	L ₁	L ₂	
HSK63A -	NPU13-175	1~13	50	175	149	12.5	2.4
HSK100A -	NPU13-180	1~13	50	180	151	12.5	3.6

• Through coolant system not available

Parts

Basic			For separate purchase
Division	Chuck	Bolt	Spanner
Parts			
Designation			
NPU8	NPU08	BX0620	NPU0836
NPU13	NPU13	BX0825	NPU1348



High speed synchro tapping chuck

DST *new*

- Tapping chuck for high speed machining
- Specially designed structure for absorbing thrust load and preventing damage on the tap
- Through coolant system available
- Applicable range: M1~M22



Code system



Excellent performance, precise machining

Expanded machining area



DST22
(vc = 100 m/min)

Excellent cutting face

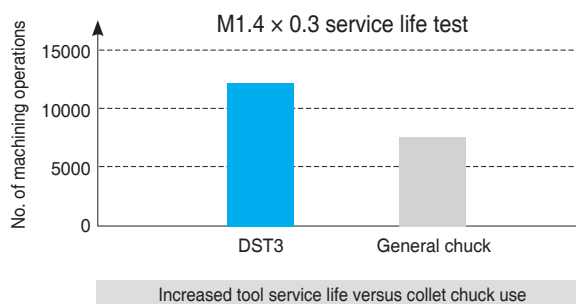


Conventional one



Exclusive collet for tapping

- At tapping work use of TER collet
- DST3: Use of ER11 collet

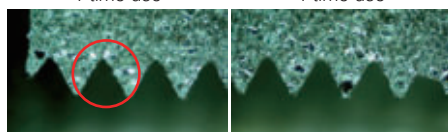


Comparison of thread figures

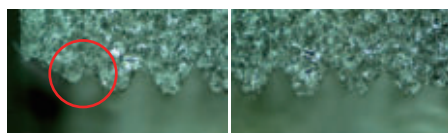
Intro part after 1 time use

End part after 1 time use

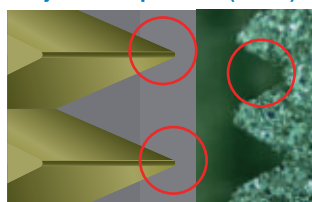
DST



Collet chuck

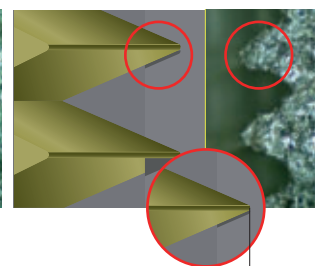


Synchro tap chuck (DST7)



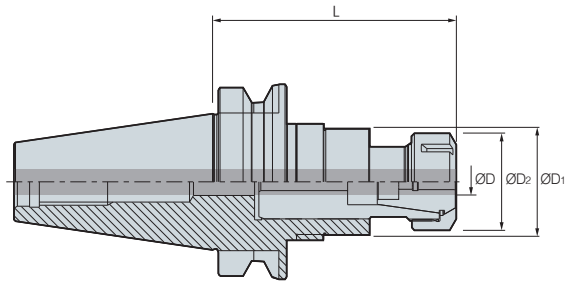
The threads have a good figure, and didn't get out of its shape

General collet chuck





The thread is out of its shape due to synchronization error

BT-DST



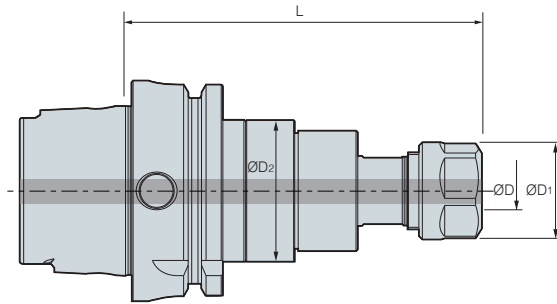
(mm)

Designation	ØD	ØD ₁	ØD ₂	L	Collet	F-	F +		
BT30 -	DST3-70	M1~M3	20	19	70	ER11	0.5	0.5	0.5
	DST10-100	M3~M10	40.4	28	100	TER16	0.5	0.5	0.8
BT40 -	DST3-70	M1~M3	20	19	70	ER11	0.5	0.5	1.0
	DST10-100	M3~M10	40.4	28	100	TER16	0.5	0.5	1.3
	DST22-110	M6~M22	60	49.5	110	TER32	0.7	0.7	1.7
BT50 -	DST10-110	M3~M10	60	49.5	110	TER16	0.5	0.5	3.8
	DST22-130	M6~M22	60	49.5	130	TER32	0.7	0.7	4.5


 Applicable collet **G36, G43**


• Through coolant system is optional

HSK-DST

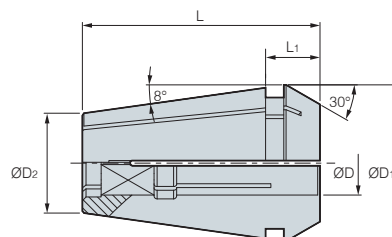
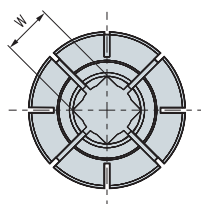
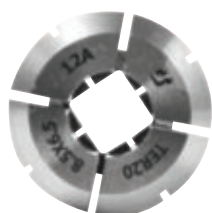


(mm)


Designation	ØD	ØD ₁	ØD ₂	L	Collet	F-	F +		
HSK63A -	DST3-80	M1~M3	19	20	80	ER11	0.5	0.5	0.7
	DST10-100	M3~M10	28	40.4	100	TER16	0.5	0.5	0.9
	DST22 130	M6~M22	49.5	60	130	TER32	0.7	0.7	1.8

 Applicable collet **G36, G43**

• Through coolant system is optional



(mm)

Designation	Tapping Range	ØD	ØD ₁	ØD ₂	L	L ₁	W		
TER16 -	4x3.2	M3	4	16.74	10.1	27.5	6.3	3.2	0.03
	5x4	M4	5	16.74	10.1	27.5	6.3	4	0.03
	5.5x4.5	M5	5.5	16.74	10.1	27.5	6.3	4.5	0.02
	6x4.5	M6, U1/4	6	16.74	10.1	27.5	6.3	4.5	0.02
	6.2x5	M7, M8	6.2	16.74	10.1	27.5	6.3	5	0.02
	7x5.5	M9, M10, U3/8	7	16.74	10.1	27.5	6.3	5.5	0.02
TER20 -	5x4	M4	5	20.74	13.2	31.5	7.2	4	0.05
	5.5x4.5	M5	5.5	20.74	13.2	31.5	7.2	4.5	0.05
	6x4.5	M6, U1/4	6	20.74	13.2	31.5	7.2	4.5	0.05
	6.2x5	M7, M8	6.2	20.74	13.2	31.5	7.2	5	0.04
	7x5.5	M9, M10, U3/8	7	20.74	13.2	31.5	7.2	5.5	0.05
	8x6	M11, U7/16, P1/8	8	20.74	-	-	-	6	0.04
	8.5x6.5	M12	8.5	20.74	13.2	31.5	7.2	6.5	0.04
TER25 -	5x4	M4	5	25.74	17.6	34	7.5	4	0.9
	5.5x4.5	M5	5.5	25.74	17.6	34	7.5	4.5	0.8
	6x4.5	M6	6	25.74	17.6	34	7.5	4.5	0.8
	6.2x5	M7, M8	6.2	25.74	17.6	34	7.5	5	0.1
	7x5.5	M9, M10, U3/8	7	25.74	17.6	34	7.5	5.5	0.8
	8.5x6.5	M12	8.5	25.74	17.6	34	7.5	6.5	0.8
TER32 -	6x4.5	M6, U1/4	6	32.74	23.1	40	8.2	4.5	0.2
	6.2x5	M7, M8	6.2	32.74	23.1	40	8.2	5	0.2
	7x5.5	M9, M10, U3/8	7	32.74	23.1	40	8.2	5.5	0.2
	8X6	M11, U7/16, P1/8	8	32.74	23.1	40	8.2	6	0.2
	8.5x6.5	M12	8.5	32.74	23.1	40	8.2	6.5	0.2
	10.5x8	M14, U9/16	10.5	32.74	23.1	40	8.2	8	0.2
	12.5x10	M16	12.5	32.74	23.1	40	8.2	10	0.2
	14x11	M18, P3/8	14	32.74	23.1	40	8.2	11	0.1
	15x12	M20	15	32.74	23.1	40	8.2	12	0.1
	17x13	M22, U7/8	17	32.74	23.1	40	8.2	13	0.1
	11x9	P1/4	11	32.74	23.1	40	8.2	9	0.2
	12x9	U5/8	12	32.74	23.1	40	8.2	9	0.2
	9x7	U1/2	9	32.74	23.1	40	8.2	7	0.2

• Water proof tapping is possible with the use of RTJW and nuts (limited to the right sizes)



Tapping holder

DTN

- Compact design and slim type
- Improvement of tapping force
- Tapping range: M3~M38

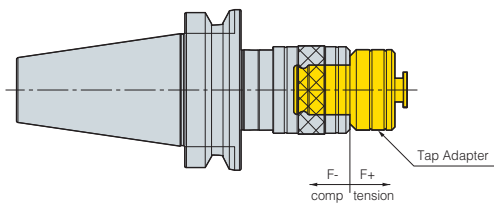


Code system



Easy exchange of TCA (Tap adaptor)

Convenient one-touch exchange type for high precision and longer tool life
 Contraction of length is possible by axial floating way

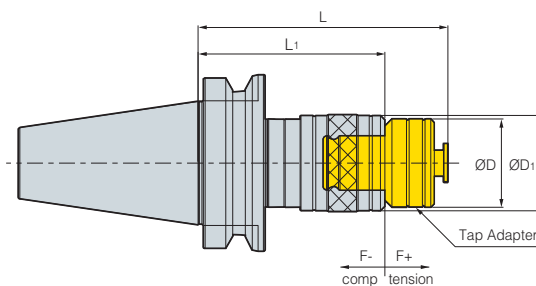


How to clamp TCA and a tap holder

Before installation	After installation	Disassembly
<ol style="list-style-type: none"> 1. Insert TCA pushing the cover of tap holder 2. Clamp the TCA in the Key groove and firmly 	<ol style="list-style-type: none"> 1. The cover of tap holder is placed correctly 	<ol style="list-style-type: none"> 1. Separate the TCA pushing the cover of tap holder



BT-DTN

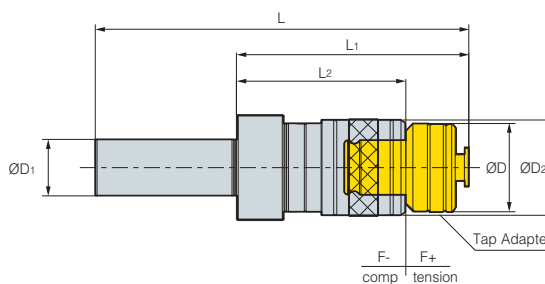


Designation		Tapping range	ØD	ØD ₁	L	L ₁	Adaptor	F-	F+	kg
BT30 -	DTN12-85	M3~M12	32	39	85	60	TCA1-M	4	10	0.5
	DTN12-90	M3~M12	32	39	90	65	TCA1-M	4	10	1.2
BT40 -	DTN12-120	M3~M12	32	39	120	95	TCA1-M	4	10	1.5
	DTN22-130	M8~M24	50	56	130	96	TCA2-M	12.5	12.5	1.7
	DTN22-160	M8~M24	50	56	160	126	TCA2-M	12.5	12.5	2.2
BT50 -	DTN12-100	M3~M12	32	39	100	75	TCA1-M	4	10	3.9
	DTN12-130	M3~M12	32	39	130	105	TCA1-M	4	10	3.9
	DTN22-140	M8~M24	50	56	140	106	TCA2-M	12.5	12.5	4.3
	DTN22-170	M8~M24	50	56	170	136	TCA2-M	12.5	12.5	4.7
	DTN38-185	M16~M38	72	81	185	140	TCA3-M	20	20	5.7
	DTN38-215	M16~M38	72	81	215	170	TCA3-M	20	20	6.7

Tap Adapter (TCA) G46

• Through coolant system not available

S-DTN

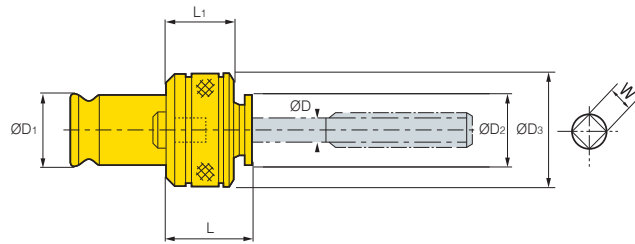


Designation		Tapping range	ØD	ØD ₁	ØD ₂	L	L ₁	L ₂	F-	F+	Adaptor	kg
S32 -	DTN12-90	M3-M12	32	32	39	170	90	65	4	10	TCA1	1.0
	DTN22-130	M8-M24	32	50	56	210	130	96	12.5	12.5	TCA2	1.8


Tap Adapter (TCA) G46

• Through coolant system not available

TCA Tap Adaptor



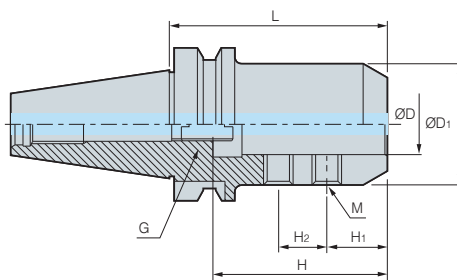
(mm)

Designation		ØD	ØD ₁	ØD ₂	ØD ₃	L	L ₁	W	
TCA1 -	M3	4	19	18.5	32	26.5	24.5	3.2	0.2
	M4	5	19	18.5	32	26.5	24.5	4	0.2
	M5	5.5	19	18.5	32	26.5	24.5	4	0.2
	M6	6	19	18.5	32	26.5	24.5	4	0.2
	M8	6.2	19	18.5	32	26.5	24.5	5	0.2
	M10	7	19	18.5	32	26.5	24.5	5.5	0.2
	M11	8	19	18.5	32	26.5	24.5	6	0.2
	M12	8.5	19	18.5	32	26.5	24.5	6.5	0.2
TCA2 -	M8	6.2	31	29	50	34	30.5	5	0.5
	M10	7	31	29	50	34	30.5	5.5	0.5
	M12	8.5	31	29	50	34	30.5	6.5	0.5
	M14	10.5	31	29	50	34	30.5	8	0.5
	P(=1/4)	11	31	29	50	34	30.5	9	0.5
	M16	12.5	31	29	50	34	30.5	10	0.5
	M18	14	31	29	50	34	30.5	11	0.5
	M20	15	31	29	50	34	30.5	12	0.5
	M22	17	31	29	50	34	30.5	13	0.5
	P1/2	18	31	29	50	34	30.5	14	0.5
	M24	19	31	29	50	34	30.5	15	0.5
	TCA3 -	M16	12.5	48	46	72	45	41	10
M18		14	48	46	72	45	41	11	1.4
M20		15	48	46	72	45	41	12	1.4
M22		17	48	46	72	45	41	13	1.4
M24		19	48	46	72	45	41	15	1.4
M27		20	48	46	72	45	41	15	1.4
M30		23	48	46	72	45	41	17	1.4
M33		25	48	46	72	45	41	19	1.4
M36	28	48	46	72	45	41	21	1.4	

• Through coolant system not available



BT-SLA



(mm)

Designation	ØD	ØD ₁	L	H	H ₁	H ₂	M	G	kg	
BT30 -	SLA16-90	16	40	90	72	25	20	M10	M12	0.9
	SLA20-90	20	50	90	72	25	20	M12	M12	1.2
	SLA25-90	25	50	90	72	25	20	M12	M12	1.1
BT40 -	SLA16-90	16	40	90	72	25	20	M10	M12	1.4
	SLA20-90	20	50	90	72	25	20	M12	M12	1.8
	SLA25-90	25	50	90	72	25	20	M12	M12	1.6
	SLA32-90	32	60	90	82	25	25	M14	M12	1.8
	SLA32-105	32	60	105	82	25	25	M14	M12	2.0
	SLA40-105	40	80	105	82	25	25	M16	M12	2.9
BT50 -	SLA20-105	20	50	105	72	25	20	M12	M12	4.4
	SLA25-105	25	50	105	72	25	20	M12	M12	4.3
	SLA32-105	32	60	105	82	25	25	M14	M12	4.5
	SLA40-105	40	90	105	82	25	20	M16	M12	6.1
	SLA42-105	42	90	105	80	25	25	M16	M12	5.9

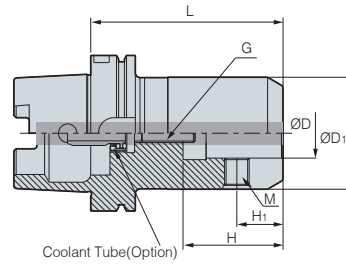
• H: Insertion depth of tool • Through coolant system installed

Parts

Division	Basic		Adjust screw	For separate purchase	
	Set screw			Wrench	
Parts					
	Designation	BT type		HSK type	BT type
	SLA16	BTF1010	BTF1414-1.5	LW-5	LW-6
	SLA20	BTF1212-1.5	BTF1616-1.5	LW-6	LW-8
	SLA25	BTF1212-1.5	BTF1818-1.5	LW-6	LW-8
	SLA32	BTF1414-1.5	BTF2020-1.5	LW-6	LW-10
	SLA40	BTF1624-1.5	BTF2020-1.5	LW-8	LW-10
	SLA42	BTF1624-1.5	BTF2020-1.5	LW-8	LW-10



HSK-SLA



(mm)

Designation		ØD	ØD ₁	L	H	H ₁	M	G	kg
HSK63A -	SLA20-100	20	52	100	51	25	M8	M12	1.6
	SLA25-105	25	65	105	59	25	M8	M12	2.1
	SLA32-105	32	72	105	63	30	M5	M12	2.3
HSK100A -	SLA20-105	20	52	105	51	25	M16	M12	3.1
	SLA25-110	25	65	110	59	25	M18	M12	3.8
	SLA32-125	32	72	125	63	30	M20	M12	4.4

• H: Insertion depth of tool • Through coolant system is optional

Parts

Basic			For separate purchase		
Division	Set screw		Adjust screw	Wrench	
Parts Designation					
	BT type	HSK type		BT type	HSK type
SLA20	BTF1212-1.5	BTF1616-1.5	M1230C	LW-6	LW-8
SLA25	BTF1212-1.5	BTF1818-1.5		LW-6	LW-8
SLA32	BTF1414-1.5	BTF2020-1.5		LW-6	LW-10

Division	For separate purchase
Internal coolant system	

Classification by shank	
HSK50	HSK50A-CNS
HSK63	HSK63A-CNS
HSK100	HSK100A-CNS



BT-FMA

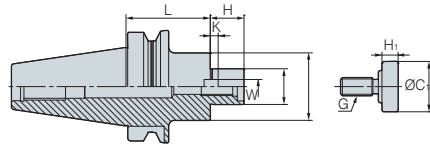


Fig. 1

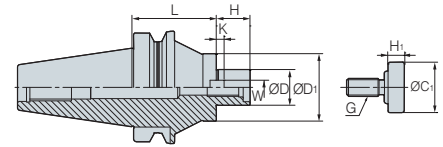


Fig. 2

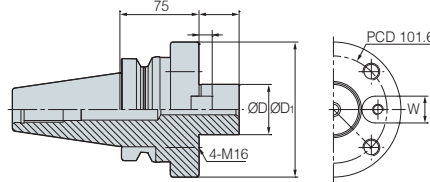


Fig. 3

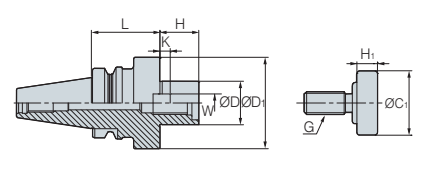


Fig. 4

(mm)

Designation	Cutter dia.	ØD	ØD ₁	L	H	W	K	G	$\frac{Q}{kg}$	Fig.
BT30 - FMA25.4-45	80	25.4	50	45	22	9.5	5	M12	1.0	4
BT40 - FMA25.4-45	80	25.4	50	45	22	9.5	5	M12	1.4	1
FMA25.4-90	80	25.4	50	90	22	9.5	5	M12	2.2	1
FMA31.75-45	100	31.75	60	45	30	12.7	7	M16	1.6	1
FMA31.75-90	100	31.75	60	90	30	12.7	7	M16	2.5	1
FMA38.1-60	125	38.1	80	60	34	15.87	9	M20	2.6	4
BT50 - FMA25.4-45	80	25.4	50	45	22	9.5	5	M12	4.0	1
FMA25.4-90	80	25.4	50	90	22	9.5	5	M12	4.7	1
FMA25.4-150	80	25.4	50	150	22	9.5	5	M12	6.4	2
FMA31.75-45	100	31.75	60	45	30	12.7	7	M16	4.1	1
FMA31.75-75	100	31.75	60	75	30	12.7	7	M16	4.8	1
FMA31.75-105	100	31.75	60	105	30	12.7	7	M16	5.6	2
FMA38.1-45	125	38.1	80	45	34	15.87	9	M20	4.4	1
FMA38.1-75	125	38.1	80	75	34	15.87	9	M20	5.6	1
FMA50.8-45	160	50.8	100	45	36	19.05	10	M24	4.9	1
FMA50.8-75	160	50.8	100	75	36	19.05	10	M24	6.8	1
FMA47.625-75	200	47.625	128	75	38	25.4	12.5	-	8.3	3

• H: Insertion depth of tool • Through coolant system is optional • The weight above exclude the face cutter

Parts

Division	Basic				For separate purchase
	Key	Key bolt	Mount bolt	Clamp bolt	Wrench
Parts					
Designation					
FMA25.4	K9.5	BX0412	MBA-M12	BX1230	LW-10
FMA31.75	K12.7	BX0515	MBA-M16	-	LW-14
FMA38.1	K15.87	BX0616	MBA-M20	-	LW-17
FMA50.8	K19.05	BX0820	MBA-M24	-	-
FMA47.625	K25.4	BX1020	-	BX1645	-



BT-FMC

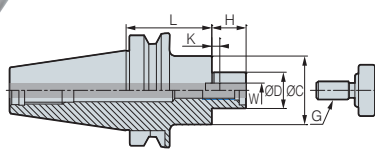
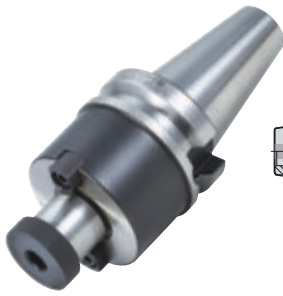


Fig. 1

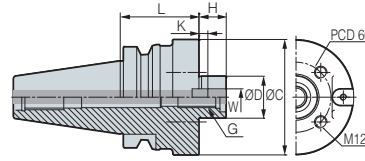


Fig. 2

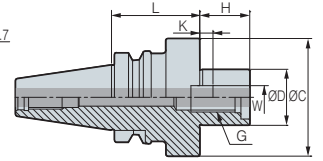








Fig. 3

(mm)

Designation	Cutter dia.	ØD	ØD ₁	L	H	W	K	G		Fig.	
BT30 -	FMC16-45	40	16	38	45	17	8	5.0	M8	0.7	1
	FMC22-45	50/63	22	48	45	19	10	5.6	M10	0.8	2
	FMC27-50	80	27	60	50	21	12	6.3	M12	1.2	2
BT40 -	FMC16-60	40	16	38	60	17	8	5.0	M8	1.2	1
	FMC22-45	50/63	22	48	45	19	10	5.6	M10	1.2	1
	FMC22-90	50/63	22	48	90	19	10	5.6	M10	1.2	1
	FMC27-60	80	27	60	60	21	12	6.3	M12	1.8	1
	FMC27-90	80	27	60	90	21	12	6.3	M12	3.2	1
	FMC32-60	100	32	78	60	24	14	7.0	M16	2.3	2
	FMC40-50	125/160	40	89	50	27	15.87	8.0	M20	3.3	3
	BT50 -	FMC16-60	40	16	38	60	17	8	5.0	M8	3.9
FMC22-60		50/63	22	48	60	19	10	5.6	M10	4.1	1
FMC27-40		80	27	60	40	21	12	6.3	M12	4.1	1
FMC27-90		80	27	60	90	21	12	6.3	M12	5.5	1
FMC27-150		80	27	60	150	21	12	6.3	M12	6.1	1
FMC32-45		100	32	78	45	24	14	7.0	M16	4.2	1
FMC32-75		100	32	78	75	24	14	7.0	M16	4.2	1
FMC32-105		100	32	78	105	24	14	7.0	M16	4.2	1
FMC40-50		125/160	40	89	50	27	15.87	8.0	M20	4.6	2

• H: Insertion depth of tool • Through coolant system is optional • The weight above exclude the face cutter

Parts

Division	Basic				For separate purchase
	Key	Mount bolt	Key bolt	Clamp bolt	Wrench
Parts					
Designation					
FMC16	K8.0	-	BX0310	BX0830	LW-6
FMC22	K10.0	-	BX0412	BX1030	LW-8
FMC27	K12.0	MBA-M12	BX0616	BX1230	LW-10
FMC32	K14.0	MBA-M16	BX0616	-	LW-14
FMC40	K15.87	MBA-M20	BX0616	BX1030	LW-17



HSK-FMC

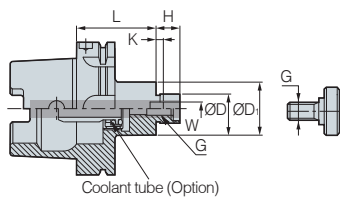


Fig. 1

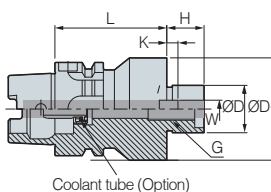


Fig. 2

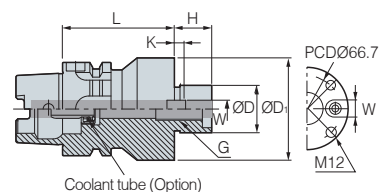


Fig. 3

(mm)

Designation	Cutter dia.	ØD	ØD ₁	L	H	W	K	G	kg	Fig.	
HSK50A -	FMC16-40	40	16	38	40	17	8	5	M8	0.4	1
	FMC22-50	50/63	22	48	50	19	10	5.6	M10	0.8	1
HSK63A -	FMC16-50	40	16	38	50	17	8	5.0	M8	0.9	1
	FMC22-50	50/63	22	48	50	19	10	5.6	M10	1.1	1
	FMC27-60	80	27	60	60	21	12	6.3	M12	1.4	1
	FMC32-60	100	32	78	60	24	14	7.0	M16	1.7	2
	FMC40-60	125/160	40	89	60	27	15.87	8.0	M20	2.5	3

• H: Insertion depth of tool • Through coolant system is optional • The weight above exclude the face cutter

Parts

Division	Basic				For separate purchase
	Key	Mount bolt	Key bolt	Clamp bolt	Wrench
Parts					
Designation					
FMC16	K8.0	-	BX0310	BX0830	LW-6
FMC22	K10.0	-	BX0412	BX1030	LW-8
FMC27	K12.0	MBA-M12	BX0516	BX1230	LW-10
FMC32	K14.0	MBA-M16	BX0616	-	LW-14
FMC40	K15.87	MBA-M20	BX0616	BX1230	LW-17

BT-MD

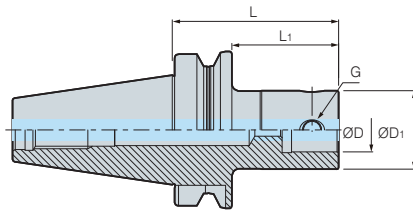


Fig. 1

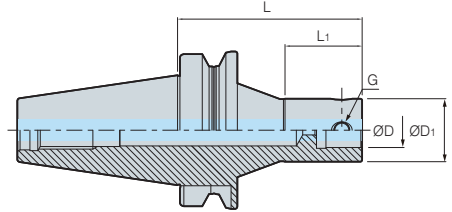



Fig. 2

(mm)

Designation	ØD	ØD ₁	L	L ₁	G	 kg	Fig.	
BT30 -	MD19F-70	11	19	70	45	M5	0.5	1
	MD25F-90	14	25	90	63	M6	0.6	1
	MD32F-80	18	32	80	55	M8	0.7	1
	MD40F-45	22	40	45	22	M10	0.5	1
	MD40F-60	22	40	60	36	M10	0.7	1
	MD40F-80	22	40	80	56	M10	0.9	1
	MD50F-70	28	50	70	48	M12	0.9	1
BT40 -	MD19F-70	11	19	70	40	M5	1.0	1
	MD25F-95	14	25	95	63	M6	1.1	1
	MD25F-105R	14	25	105	40	M6	1.2	2
	MD32F-100	18	32	100	70	M8	1.2	1
	MD32F-115R	18	32	115	45	M8	1.5	2
	MD40F-60	22	40	60	31	M10	1.1	1
	MD40F-110R	22	40	110	60	M10	1.6	2
	MD40F-115	22	40	115	83	M10	1.6	1
	MD50F-105	28	50	105	73	M12	1.8	1
	MD63F-64	36	63	64	37	M16	1.5	1
	MD63F-110	36	63	110	83	M16	2.4	1
	MD63F-135	36	63	135	108	M16	3.0	1
	MD80F-100	45	80	100	73	M16	2.9	1
BT50 -	MD19F-85	11	19	85	44	M5	3.7	1
	MD25F-105	14	25	105	62	M6	3.8	1
	MD25F-120R	14	25	120	40	M6	3.8	2
	MD32F-110	18	32	110	67	M8	4.0	1
	MD32F-115R	18	32	115	45	M8	4.1	2
	MD32F-235R	18	32	235	115	M8	5.5	2
	MD40F-60	22	40	60	22	M10	3.7	1
	MD40F-195	22	40	195	152	M10	4.8	1
	MD40F-230R	22	40	230	180	M10	5.0	2
	MD50F-125	28	50	125	82	M12	4.6	1
	MD50F-225	28	50	225	182	M12	6.0	1
	MD50F-250R	28	50	250	81	M12	7.0	2
	MD63F-75	36	63	75	35	M16	4.2	1
	MD63F-130	36	63	130	87	M16	5.3	1
	MD63F-195	36	63	195	152	M16	6.8	1
	MD63F-230	36	63	230	187	M16	7.5	1
	MD80F-75	45	80	75	36	M16	4.3	1
	MD80F-110	45	80	110	69	M16	5.7	1
	MD80F-175	45	80	175	134	M16	8.0	1
	MD90F-75	45	90	75	34	M16	4.8	1
MD90F-145	45	90	145	104	M16	7.4	1	
MD90F-195	45	90	195	154	M16	9.4	1	

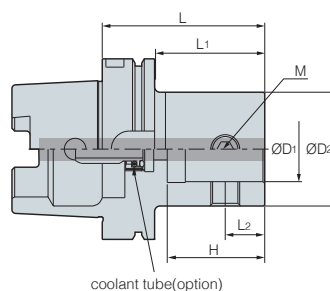
 Spare Part G53

• Through coolant system installed




HSK-MD

Modular Arbor






(mm)

Designation	ØD ₁	ØD ₂	L	L ₁	H	M		
HSK 63A -	MD19F-60	11	19	60	31	15.5	M5	0.7
	MD25F-60	14	25	60	31	18.5	M6	0.7
	MD32F-65	18	32	65	36	23.5	M8	0.8
	MD40F-70	22	40	70	41	29	M10	0.9
	MD50F-85	28	50	85	58	36	M12	1.3
	MD63F-95	36	63	95	69	46	M16	1.7

• Through coolant system is optional

Parts

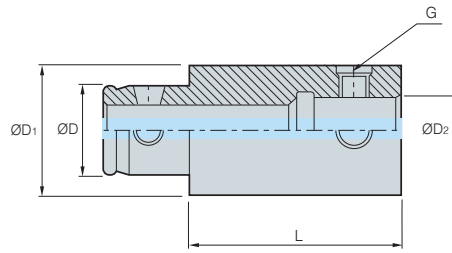
Basic		For separate purchase
Division	Taper screw	Wrench
Parts		
Designation		
MD19F	BTT0506F	LW-2.5
MD25F	BTT0608F	LW-3
MD32F	BTT0810F	LW-4
MD40F	BTT1013F	LW-5
MD50F	BTT1215F	LW-6
MD63F	BTT1620F	LW-8
MD80F	BTT1626F	LW-8
MD90F	BTT1631F	LW-8

Division	For separate purchase
Internal coolant system	


Classification by shank	
HSK50	HSK50A-CNS
HSK63	HSK63A-CNS
HSK100	HSK100A-CNS



EXT Extension Bar

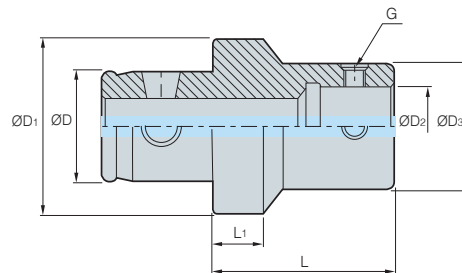


(mm)


Designation	ØD	ØD ₁	ØD ₂	L	G		
EXT	1930F	11	19	11	30	M5	0.1
	1950F	11	19	11	50	M5	0.1
	2530F	14	25	14	30	M6	0.1
	2550F	14	25	14	50	M6	0.2
	3235F	18	32	18	35	M8	0.2
	3260F	18	32	18	60	M8	0.4
	4040F	22	40	22	40	M10	0.4
	4090F	22	40	22	90	M10	0.9
	5050F	28	50	28	50	M12	0.7
	50100F	28	50	28	100	M12	1.4
	6360F	36	63	36	60	M16	1.4
	63120F	36	63	36	120	M16	2.9
	8070F	45	80	45	70	M16	2.5
	80120F	45	80	45	120	M16	4.5
	9080F	45	90	45	80	M16	3.8
90130F	45	90	45	130	M16	6.4	

• Through coolant system installed

RDC Reducer Bar



(mm)

Designation	ØD	ØD ₁	ØD ₂	ØD ₃	L	L ₁	G		
RDC	3225F	18	32	14	25	30	9	M6	0.1
	4025F	22	40	14	25	30	9	M6	0.3
	4032F	22	40	18	32	30	9	M8	0.2
	5025F	28	50	14	25	30	9	M6	0.3
	5032F	28	50	18	32	40	9	M8	0.3
	5040F	28	50	22	40	40	10	M10	0.5
	6325F	36	63	14	25	30	9	M6	0.6
	6332F	36	63	18	32	40	9	M8	0.6
	6340F	36	63	22	40	40	10	M10	0.7
	6350F	36	63	28	50	45	10	M12	0.9
	8040F	45	80	22	40	40	10	M10	1.2
	8050F	45	80	28	50	45	10	M12	1.3
	8063F	45	80	36	63	50	13	M16	1.6

• Through coolant system installed



FBH back boring & balanced type

FBH/B

- High speed boring and back boring capability
- High precision balancing: G2.5, Head: G6.3
- Min. adjustment range: 2 μm



Code system



Back boring range calculation



- A: Boring range (Ø)
- B: FBH/B body size (Ø)
- C: Diameter for pass (Ø)

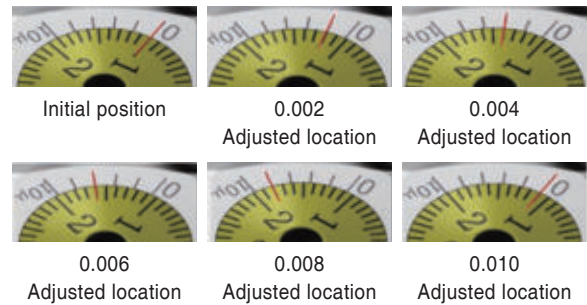
Designation	Min. diameter for pass (Ø)
FBH1920B	≥ Ø24
FBH2526B	≥ Ø30.5
FBH3233B	≥ Ø35
FBH4042B	≥ Ø44
FBH5053B	≥ Ø54
FBH6368B	≥ Ø71.5
FBH6398B	≥ Ø100
FBH8098B	≥ Ø100

A	Max. range of back boring (Ø)	A Max. value = (2 x C) - B
B	B Max. FBH body size (Ø)	B Max. value = (2 x C) - A
C	C Min. diameter for pass (Ø)	C Min. value = (A + B) / 2

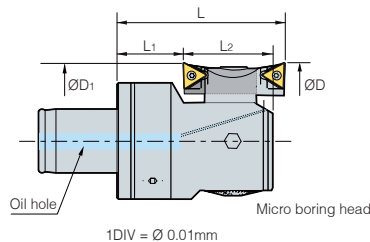
Boring range adjustment method

Fine adjustment: 2 μm Boring range

Can be adjusted at a rate of 2 μm by using the main scale and vernier scale



Boring range



Designation	Boring range Ø			Backboring Range (Ø)			
	Min	Max	L	Min	Max	L ₁	L ₂
FBH1920B	20	26 (30)	35.3	29	30	13.1	18.6
FBH2526B	26	34 (40)	40.9	36	40	15.1	21.9
FBH3233B	33	43 (50)	40.9	38	46 (50)	13.1	24.9
FBH4042B	42	54 (62)	50.4	48	54 (62)	15.2	31.4
FBH5053B	53	70 (82)	58.4	58	70 (82)	15.7	38.4
FBH6368B	68	100 (122)	80.6	78	100 (122)	27.4	48.6
FBH6398B	98	150 (172)	100.6	106	150 (172)	47.4	48.6
FBH8098B	98	150 (172)	100.6	106	150 (172)	47.4	48.6



BT-FBH/B

Micro Boring Balance type

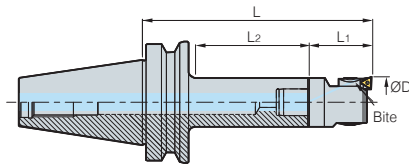
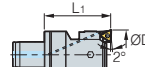


Fig. 1



Head

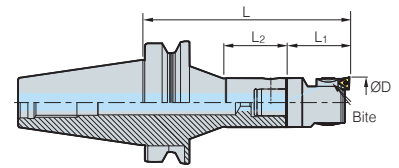


Fig. 2

(mm)

Head	Designation		Boring range ØD		ØD	ØD ₁	L	L ₁	L ₂	kg	Fig.
	Bite	Arbor	Min	Max							
FBH1920B	FBB20N-□-□□	BT30-MD19F-70	20 (24)	26 (30)	19	11	105.2	35.2	45	0.2	1
FBH2526B	FBB26N-□-□□	BT30-MD25F-90	26 (32)	34 (40)	25	14	131	41	63	0.2	1
FBH3233B	FBB33N-□-□□	BT30-MD32F-80	33 (40)	43 (50)	32	18	121	41	55	0.3	1
FBH4042B	FBB42N-□-□□	BT30-MD40F-45	42 (50)	54 (62)	40	22	95.5	50.5	22	0.5	1
FBH4042B	FBB42N-□-□□	BT30-MD40F-60	42 (50)	54 (62)	40	22	110.5	50.5	36	0.5	1
FBH4042B	FBB42N-□-□□	BT30-MD40F-80	42 (50)	54 (62)	40	22	130.5	50.5	56	0.5	1
FBH5053B	FBB53N-□-□□	BT30-MD50F-70	53 (65)	70 (82)	50	28	128.4	58.5	48	0.8	1
FBH1920B	FBB20N-□-□□	BT40-MD19F-70	20 (24)	26 (30)	19	11	105.4	35.2	40	0.2	1
FBH2526B	FBB26N-□-□□	BT40-MD25F-95	26 (32)	34 (40)	25	14	135.9	41	63	0.2	1
FBH2526B	FBB26N-□-□□	BT40-MD25F-105R	26 (32)	34 (40)	25	14	146	41	40	0.2	2
FBH3233B	FBB33N-□-□□	BT40-MD32F-100	33 (40)	43 (50)	32	18	140.9	41	70	0.3	1
FBH3233B	FBB33N-□-□□	BT40-MD32F-115R	33 (40)	43 (50)	32	18	156	41	45	0.3	2
FBH4042B	FBB42N-□-□□	BT40-MD40F-60	42 (50)	54 (62)	40	22	165.5	50.5	31	0.5	1
FBH4042B	FBB42N-□-□□	BT40-MD40F-110R	42 (50)	54 (62)	40	22	160.5	50.5	60	0.5	2
FBH4042B	FBB42N-□-□□	BT40-MD40F-15	42 (50)	54 (62)	40	22	165.5	50.5	83	0.5	1
FBH5053B	FBB53N-□-□□	BT40-MD50F-105	53 (65)	70 (82)	50	28	163.4	58.5	73	0.8	1
FBH5053B	FBB53N-□-□□	BT40-MD63F-64	53 (65)	70 (82)	50	28	122.5	58.5	37	0.8	1
FBH6368B	FBB68N-□-□□	BT40-MD63F-110	68 (90)	100 (122)	63	36	190.6	80.6	83	2.1	1
FBH6398B	FBB68N-□-□□	BT40-MD63F-135	98 (120)	150 (172)	63	36	235.6	100.6	108	3.6	1
FBH8098B	FBB68N-□-□□	BT40-MD80F-100	98 (120)	150 (172)	80	45	200.6	100.6	73	4.8	1

➔ Spare Part G59 ➔ FBB Bite G61

• Head: Basic, Bite/Arbor: For separate purchase • Through coolant system installed

* FBB bites are divided into two sorts Normal type: FBB□□N, Scalable type: FBB□□N-1
There are also the other options for your insert type: FBB□□N-□-C09 or T11

Bite	Applicable insert
FBB□□N, FBB□□N-1	TPGT, TPGW0802□□L
FBB□□N-□-C	CCMT, CCGT0602□□L
FBB□□N-□-C09	CCMT, CCGT09T3□□L
FBB□□N-□-T11	TPGT1103□□L



BT-FBH/B

Micro Boring Balance type

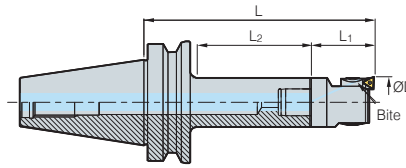
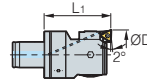


Fig. 1



Head

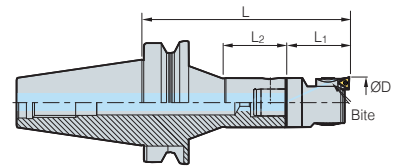


Fig. 2

(mm)

Head	Designation		Boring range ØD		ØD	ØD ₁	L	L ₁	L ₂	kg	Fig.
	Bite	Arbor	Min	Max							
FBH1920B	FBB20N-□-□□	BT50-MD19F-85	20 (24)	26 (30)	19	11	120.2	35.2	44	0.2	1
FBH2526B	FBB26N-□-□□	BT50-MD25F-105	26 (32)	34 (40)	25	14	146	41	62	0.2	1
FBH2526B	FBB26N-□-□□	BT50-MD25F-120R	26 (32)	34 (40)	25	14	161	41	40	0.2	2
FBH3233B	FBB33N-□-□□	BT50-MD32F-110	33 (40)	43 (50)	32	18	151	41	67	0.3	1
FBH3233B	FBB33N-□-□□	BT50-MD32F-115R	33 (40)	43 (50)	32	18	156	41	45	0.3	2
FBH3233B	FBB33N-□-□□	BT50-MD32F-235R	33 (40)	43 (50)	32	18	276	41	115	0.3	2
FBH4042B	FBB42N-□-□□	BT50-MD40F-60	42 (50)	54 (62)	32	18	110.5	50.5	22	0.5	1
FBH4042B	FBB42N-□-□□	BT50-MD40F-195	42 (50)	54 (62)	40	22	245.5	50.5	152	0.5	1
FBH4042B	FBB42N-□-□□	BT50-MD40F-230R	42 (50)	54 (62)	40	22	280.5	50.5	180	0.5	2
FBH5053B	FBB53N-□-□□	BT50-MD50F-125	53 (65)	70 (82)	40	22	183.5	58.5	82	0.8	1
FBH5053B	FBB53N-□-□□	BT50-MD50F-225	53 (65)	70 (82)	50	28	283.5	58.5	182	0.8	1
FBH5053B	FBB53N-□-□□	BT50-MD50F-205R	53 (65)	70 (82)	50	28	263.5	58.5	81	0.8	2
FBH6368B	FBB68N-□-□□	BT50-MD63F-75	68 (90)	100 (122)	63	36	145.6	80.6	35	2.1	1
FBH6368B	FBB68N-□-□□	BT50-MD63F-130	68 (90)	100 (122)	63	36	210.6	80.6	87	2.1	1
FBH6368B	FBB68N-□-□□	BT50-MD63F-195	68 (90)	100 (122)	63	36	275.6	80.6	152	2.1	1
FBH6368B	FBB68N-□-□□	BT50-MD63F-230	68 (90)	100 (122)	63	36	310.6	80.6	187	2.1	1
FBH6398B	FBB68N-□-□□	BT50-MD63F-75	98 (120)	150 (172)	63	36	175.6	100.6	35	3.6	1
FBH6398B	FBB68N-□-□□	BT50-MD63F-130	98 (120)	150 (172)	63	36	230.6	100.6	87	3.6	1
FBH6398B	FBB68N-□-□□	BT50-MD63F-95	98 (120)	150 (172)	63	36	295.6	100.6	152	3.6	1
FBH6398B	FBB68N-□-□□	BT50-MD63F-230	98 (120)	150 (172)	63	36	330.6	100.6	187	3.6	1
FBH8098B	FBB68N-□-□□	BT50-MD80F-75	98 (120)	150 (172)	80	45	175.6	100.6	36	4.8	1
FBH8098B	FBB68N-□-□□	BT50-MD80F-110	98 (120)	150 (172)	80	45	215.6	100.6	69	4.8	1
FBH8098B	FBB68N-□-□□	BT50-MD80F-175	98 (120)	150 (172)	80	45	275.6	100.6	134	4.8	1

Spare Part **G59** FBB Bite **G61**

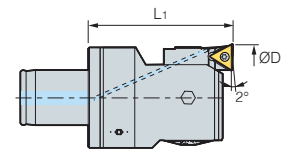
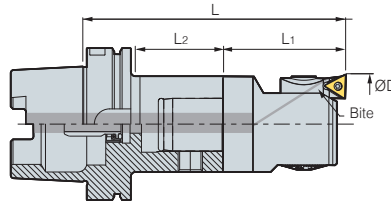
• Head: Basic, Bite/Arbor: For separate purchase • Through coolant system installed

* FBB bites are divided into two sorts Normal type: FBB□□N, Scalable type: FBB□□N-1
There are also the other options for your insert type: FBB□□N-□-C09 or T11

Bite	Applicable insert
FBB□□N, FBB□□N-1	TPGT, TPGW0802□□L
FBB□□N-□-C	CCMT, CCGT0602□□L
FBB□□N-□-C09	CCMT, CCGT09T3□□L
FBB□□N-□-T11	TPGT1103□□L

HSK-FBH/B

Micro Boring Balance type



(mm)

Designation			Boring range ØD		ØD	ØD ₁	L	L ₁	L ₂	
Head	Bite	Arbor	Min	Max						
FBH1920B	FBB20N-□-□□	HSK63A-MD19F 60	20 (24)	26 (30)	19	11	95.2	35.2	31	0.2
FBH2526B	FBB26N-□-□□	HSK63A-MD25F 60	26 (32)	34 (40)	25	14	101	41	31	0.2
FBH3233B	FBB33N-□-□□	HSK63A-MD32F 65	33 (40)	43 (50)	32	18	106	41	36	0.3
FBH4042B	FBB42N-□-□□	HSK63A-MD40F 70	42 (50)	54 (62)	40	22	120.5	50.5	41	0.5
FBH5053B	FBB53N-□-□□	HSK63A-MD50F 85	53 (65)	70 (82)	50	28	143.5	58.5	58	0.9
FBH6368B	FBB68N-□-□□	HSK63A-MD63F 95	68 (90)	100 (122)	63	36	175.6	80.6	69	2.3
FBH6398B	FBB68N-□-□□	HSK63A-MD63F 95	98 (120)	150 (172)	63	36	195.6	100.6	69	3.8

Spare Part **G59** FBB Bite **G61**

• Head: Basic, Bite/Arbor: For separate purchase • Through coolant system is optional

* FBB bites are divided into two sorts Normal type: FBB□□N, Scalable type: FBB□□N-1
There are also the other options for your insert type: FBB□□N-□-C09 or T11

Bite	Applicable insert
FBB□□N, FBB□□N-1	TPGT, TPGW0802□□L
FBB□□N-□-C	CCMT, CCGT0602□□L
FBB□□N-□-C09	CCMT, CCGT09T3□□L
FBB□□N-□-T11	TPGT1103□□L

Parts

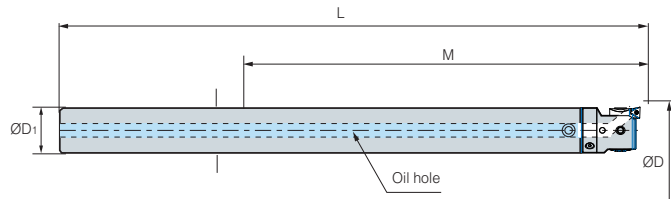
Division	For separate purchase
Internal coolant system	

Classification by shank	
HSK50	HSK50A-CNS
HSK63	HSK63A-CNS
HSK100	HSK100A-CNS



S-FBH/B

Micro Boring Balance type



(mm)

Designation	Boring range ØD		ØD ₁	L	M	Main component			kg
	Min	Max				Basic shank	Boring head	Bite	
S19W-FBH20B-120	20	26	19	192.35	120	S19W-MD19F-157	FBH1920B	FBB20N	0.6
S19W-FBH20B-140	20	26	19	212.35	140	S19W-MD19F-177	FBH1920B	FBB20N	0.7
S19W-FBH20B-160	20	26	19	232.35	160	S19W-MD19F-197	FBH1920B	FBB20N	0.8
S25W-FBH26B-150	26	34	25	238.35	150	S25W-MD25F-197.5	FBH2526B	FBB26N	1.4
S25W-FBH26B-175	26	34	25	263.35	175	S25W-MD25F-222.5	FBH2526B	FBB26N	1.6
S25W-FBH26B-200	26	34	25	288.35	200	S25W-MD25F-247.5	FBH2526B	FBB26N	1.8
S32W-FBH33B-180	33	43	32	279.9	180	S32W-MD32F-239	FBH3233B	FBB33N	2.7
S32W-FBH33B-240	33	43	32	339.9	240	S32W-MD32F-299	FBH3233B	FBB33N	3.4
S19-FBH20B-40	20	26	19	112.35	40	S19-MD19F-77	FBH1920B	FBB20N	0.2
S19-FBH20B-80	20	26	19	152.35	80	S19-MD19F-117	FBH1920B	FBB20N	0.2
S25-FBH26B-50	26	34	25	138.35	50	S25-MD25F-97.5	FBH2526B	FBB26N	0.4
S25-FBH26B-100	26	34	25	188.35	100	S25-MD25F-147.5	FBH2526B	FBB26N	0.6
S32-FBH33B-90	33	43	32	189.9	90	S32-MD32F-149	FBH3233B	FBB33N	1.1
S32-FBH33B-120	33	43	32	219.9	120	S32-MD32F-179	FBH3233B	FBB33N	1.2

Spare Part **G59** FBB Bite **G61**

• S□□W: Cemented carbide shank, S□□: steel shank • Through coolant system installed

* FBB bites are divided into two sorts Normal type: FBB□□N, Scalable type: FBB□□N-1
There are also the other options for your insert type: FBB□□N-□-C09 or T11

Bite	Applicable insert
FBB□□N, FBB□□N-1	TPGT, TPGW0802□□L
FBB□□N-□-C	CCMT, CCGT0602□□L
FBB□□N-□-C09	CCMT, CCGT09T3□□L
FBB□□N-□-T11	TPGT1103□□L

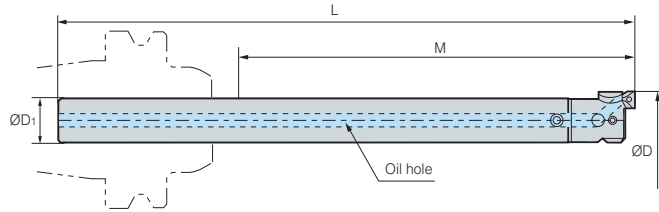
Parts

Basic			
Type (FBH/B)	Lock screw	Clamp screw	Wrench
FBH1920B	BTF0404	BXC0304	LW-2
FBH2526B	BTF0505	BXC0405	LW-2.5
FBH3233B	BTF0606	BXC0506	LW-3
FBH4042B	BTF0808	BXC0610	LW-4
FBH5053B	BTF0812	BXC0610	LW-4
FBH6368B	BTF1016	BXC0810	LW-5
FBH6398B	BTF1012	BXC0810	LW-5
FBH8098B	BTF1014	BXC0810	LW-5



S-FBH

Small Micro Boring



(mm)

Designation	Boring range ØD		ØD ₁	L	M	Designation			kg
	Min	Max				Basic shank	Boring head	Bite	
S14W-FBH15-85	15	18	14	155	85	S14W-M6-123	FBH15	FBB15-C	0.3
S14W-FBH15-110	15	18	14	180	110	S14W-M6-148	FBH15	FBB15-C	0.3
S16W-FBH18-95	18	22	16	165	95	S16W-M8-128	FBH18	FBB15-C	0.4
S16W-FBH18-125	18	22	16	195	125	S16W-M8-158	FBH18	FBB15-C	0.5
S14-FBH15-40	15	18	14	110	40	S14-M6-78	FBH15	FBB15-C	0.1
S16-FBH18-45	18	22	16	115	45	S16-M8-78	FBH18	FBB15-C	0.1





↻ Spare Part G59, G60 ↻ FBB Bite G61

• S□□W: Cemented carbide shank, S□□: steel shank • Through coolant system installed

* FBB bites are divided into two sorts Normal type: FBB□□N, Scalable type: FBB□□N-1
There are also the other options for your insert type: FBB□□N-□-C09 or T11

Bite	Applicable insert
FBB□□N, FBB□□N-1	TPGT, TPGW0802□□L
FBB□□N-□-C	CCMT, CCGT0602□□L
FBB□□N-□-C09	CCMT, CCGT09T3□□L
FBB□□N-□-T11	TPGT1103□□L

↻ Parts

Basic			
Type (FBH)	Lock screw	FBB	Clamp screw
			
FBH15	BT02503	FBB15-C	BFTX02505N
FBH18	BT02503	FBB15-C	BFTX02505N



FBB Bite

Designation	Boring range	Insert	Insert screw	Clamp bolt
FBB15-C	Ø15~Ø18 mm	CCET0301-□□L	BFTX01604N	BFTX02505N
	Ø18~Ø22 mm	CCET0301-□□L	BFTX01604N	BFTX02505N
FBB20N	Ø20~Ø26 mm	TPGT0802□□L,TPGW0802□□	BFTX0204A	BXC0304
FBB20N-C	Ø20~Ø26 mm	CCET0401□□L	FTNA0238	BXC0304
FBB20N-1	Ø24~Ø30 mm	TPGT0802□□L,TPGW0802□□	BFTX0204A	BXC0304
FBB20N-1-C	Ø24~Ø30 mm	CCET0401□□L	FTNA0238	BXC0304
FBB26N	Ø26~Ø34 mm	TPGT0802□□L,TPGW0802□□	BFTX0204A	BXC0405
FBB26N-C	Ø26~Ø34 mm	CCET0401□□L	FTNA0238	BXC0405
FBB26N-1	Ø32~Ø40 mm	TPGT0802□□L,TPGW0802□□	BFTX0204A	BXC0405
FBB26N-1-C	Ø32~Ø40 mm	CCET0401□□L	FTNA0238	BXC0405
FBB33N	Ø33~Ø43 mm	TPGT0802□□L,TPGW0802□□	BFTX0204A	BXC0506
FBB33N-C	Ø33~Ø43 mm	CCMT0602□□,CCGT0602□□	BFTX02506N	BXC0506
FBB33N-1	Ø41~Ø50 mm	TPGT0802□□L,TPGW0802□□	BFTX0204A	BXC0506
FBB33N-1-C	Ø41~Ø50 mm	CCMT0602□□,CCGT0602□□L	BFTX02506N	BXC0506
FBB42N	Ø42~Ø54 mm	TPGT0802□□L,TPGW0802□□	BFTX0204A	BXC0610
FBB42N-C	Ø42~Ø54 mm	CCMT0602□□CCGT0602□□L	BFTX02506N	BXC0610
FBB42N-11	Ø42~Ø54 mm	TPGT1103□□L	BFTX0307A	BXC0610
FBB42N-1	Ø50~Ø62 mm	TPGT0802□□L,TPGW0802□□	BFTX0204A	BXC0610
FBB42N-1-C	Ø50~Ø62 mm	CCMT0602□□,CCGT0602□□L	BFTX02506N	BXC0610
FBB42N-1-T11	Ø50~Ø62 mm	TPGT1103□□L	BFTX0307A	BXC0610
FBB53N	Ø53~Ø70 mm	TPGT0802□□L,TPGW0802□□	BFTX0204A	BXC0610
FBB53N-C	Ø53~Ø70 mm	CCMT0602□□,CCGT0602□□	BFTX02506N	BXC0610
FBB53N-11	Ø53~Ø70 mm	TPGT1103□□L	BFTX0307A	BXC0610
FBB53N-1	Ø65~Ø82 mm	TPGT0802□□L,TPGW0802□□	BFTX0204A	BXC0610
FBB53N-1-C	Ø65~Ø82 mm	CCMT0602□□CCGT0602□□L	BFTX02506N	BXC0610
FBB53N-1-C09	Ø65~Ø82 mm	CCMT09T3□□,CCGT09T3□□L	BFTX0409N	BXC0610
FBB53N-1-T11	Ø65~Ø82 mm	TPGT1103□□L	BFTX0307A	BXC0610
FBB68N	Ø68~Ø100 mm/Ø98~Ø150 mm	TPGT0802□□L,TPGW0802□□	BFTX0204A	BXC0810
FBB68N-C	Ø68~Ø100 mm/Ø98~Ø150 mm	CCMT09T3□□,CCGT09T3□□L	BFTX0409N	BXC0810
FBB68N-11	Ø68~Ø100 mm/Ø98~Ø150 mm	TPGT1103□□L	BFTX0307A	BXC0810
FBB68N-1	Ø90~Ø122 mm/Ø120~Ø172 mm	TPGT0802□□L,TPGW0802□□	BFTX0204A	BXC0810
FBB68N-1-C09	Ø90~Ø122 mm/Ø120~Ø172 mm	CCMT09T3□□,CCGT09T3□□L	BFTX0409N	BXC0810
FBB68N-1-T11	Ø90~Ø122 mm/Ø120~Ø172 mm	TPGT1103□□L	BFTX0307A	BXC0810



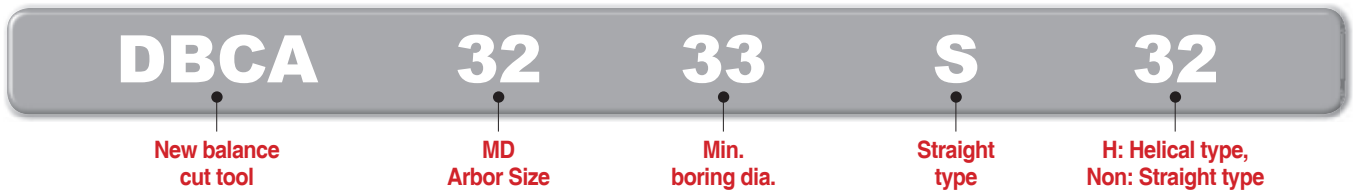
New balance cut tool

DBCA new

- Applied adjustment function simultaneously in Bi/Uni-direction of cartridge
- Improves the rigidity of cutting by applying cover for rotating type
- Increased machining area versus conventional own products
- Improved capacity to evacuate chips by unique design of helical type Head
- Boring range: Ø28~Ø136



Code system



Main features

Helical Type



- Improved capacity to discharge chips from clogged and deep holes
- Minimized damage to tools and insert due to chip clogging

Extended head length	Deep hole machining implemented
Helical Type	Improved capacity to discharge chips from holes

Boring area optimization

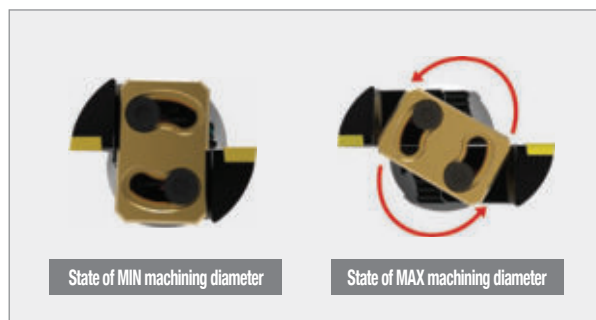


- Max. diameter expanded owing to reinforced rigidity
- Boring range expanded per model no. versus conventional boring range of DINE

Coolant Hole (Direct spray to cutting edge)	<ul style="list-style-type: none"> • Improved capacity to discharge chips • Improved capacity of machining
---	--

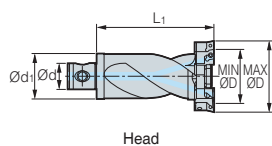
Effect of improved rigidity for cartridge by cover

Clamps the top of the cartridge stably, minimizing the vibration of tools and improving the roughness of the working surface



BT-DBC/A

Helical type



Head

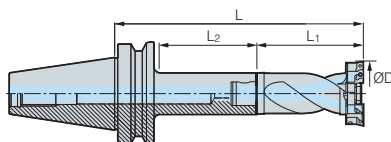


Fig. 1

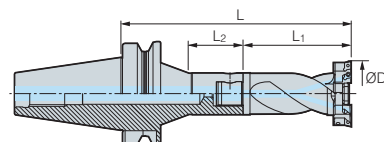


Fig. 2

(mm)

Designation		Boring range ØD		Ød	Ød ₁	L	L ₁	L ₂	kg	Fig.
Head	Arbor	Min	Max							
DBCA2528S-H	BT30-MD25F-90	28	38	14	25	193	103	63	0.3	1
DBCA3238S-H	BT30-MD32F-80	38	54	18	32	190	110	55	0.5	1
DBCA5054S-H	BT30-MD50F-70	54	74	28	50	215	145	48	1.8	1
DBCA2528S-H	BT40-MD25F-95	28	38	14	25	198	103	63	0.3	1
DBCA2528S-H	BT40-MD25F-105R	28	38	14	25	208	103	40	0.3	2
DBCA3238S-H	BT40-MD32F-100	38	54	18	32	210	110	70	0.5	1
DBCA3238S-H	BT40-MD32F-115R	38	54	18	32	225	110	45	0.5	2
DBCA5054S-H	BT40-MD50F-105	54	74	28	50	250	145	73	1.8	1
DBCA6374S-H	BT40-MD63F-64	74	100	36	63	244	180	37	3.3	1
DBCA6374S-H	BT40-MD63F-110	74	100	36	63	290	180	83	3.3	1
DBCA6374S-H	BT40-MD63F-135	74	100	36	63	315	180	108	3.3	1
DBCA80100S-H	BT40-MD80F-100	100	136	45	80	315	215	73	7.3	1
DBCA2528S-H	BT50-MD25F-105	28	38	14	25	208	103	62	0.3	1
DBCA2528S-H	BT50-MD25F-120R	28	38	14	25	223	103	40	0.3	2
DBCA3238S-H	BT50-MD32F-110	38	54	18	32	220	110	67	0.5	1
DBCA3238S-H	BT50-MD32F-115R	38	54	18	32	225	110	45	0.5	2
DBCA3238S-H	BT50-MD32F-235R	38	54	18	32	345	110	115	0.5	2
DBCA5054S-H	BT50-MD50F-125	54	74	28	50	270	145	82	1.8	1
DBCA5054S-H	BT50-MD50F-225	54	74	28	50	370	145	182	1.8	1
DBCA5054S-H	BT50-MD50F-250R	54	74	28	50	395	145	81	1.8	2
DBCA6374S-H	BT50-MD63F-75	74	100	36	63	255	180	35	3.3	1
DBCA6374S-H	BT50-MD63F-130	74	100	36	63	280	180	87	3.3	1
DBCA6374S-H	BT50-MD63F-195	74	100	36	63	375	180	152	3.3	1
DBCA6374S-H	BT50-MD63F-230	74	100	36	63	410	180	187	3.3	1
DBCA80100S-H	BT50-MD80F-75	100	136	45	80	290	215	36	7.3	1
DBCA80100S-H	BT50-MD80F-110	100	136	45	80	325	215	69	7.3	1
DBCA80100S-H	BT50-MD80F-175	100	136	45	80	390	215	134	7.3	1

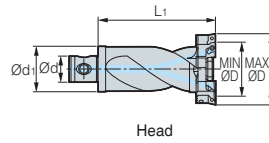
➔ Spare Part **G67**

• Head: Basic, Arbor: For separate purchase • Through coolant system installed

* In the above table, the Arbor Model No. is an example model no. and able to adjust the depth of boring with a combination of MD arbors and extension bars. For more details, see the MD arbor page.



BT-DBC/A



Head

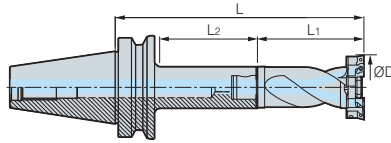


Fig. 1

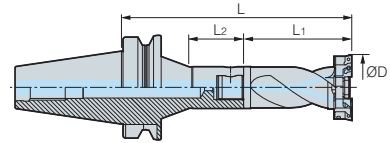


Fig. 2

(mm)

Designation		Boring range ØD		Ød	Ød ₁	L	L ₁	L ₂	ρ _{kg}	Fig.
Head	Arbor	Min	Max							
DBCA2528S	BT30-MD25F-90	28	38	14	25	193	103	63	0.2	1
DBCA3238S	BT30-MD32F-80	38	54	18	32	190	110	55	0.4	1
DBCA5054S	BT30-MD50F-70	54	74	28	50	215	145	48	1.1	1
DBCA2528S	BT40-MD25F-95	28	38	14	25	198	103	63	0.2	1
DBCA2528S	BT40-MD25F-105R	28	38	14	25	208	103	40	0.2	2
DBCA3238S	BT40-MD32F-100	38	54	18	32	210	110	70	0.4	1
DBCA3238S	BT40-MD32F-115R	38	54	18	32	225	110	45	0.4	2
DBCA5054S	BT40-MD50F-105	54	74	28	50	205	145	73	1.1	1
DBCA6374S	BT40-MD63F-64	74	100	36	63	244	180	37	1.9	1
DBCA6374S	BT40-MD63F-135	74	100	36	63	315	180	83	1.9	1
DBCA6374S	BT40-MD80F-100	74	100	36	63	280	180	108	1.9	1
DBCA80100S	BT40-MD80F-100	100	136	45	80	315	215	73	3.7	1
DBCA2528S	BT50-MD25F-105	28	38	14	25	208	103	62	0.2	1
DBCA2528S	BT50-MD25F-120R	28	38	14	25	223	103	40	0.2	2
DBCA3238S	BT50-MD32F-110	38	54	18	32	220	110	67	0.4	1
DBCA3238S	BT50-MD32F-115R	38	54	18	32	225	110	45	0.4	2
DBCA3238S	BT50-MD32F-235R	38	54	18	32	345	110	115	0.4	2
DBCA5054S	BT50-MD50F-125	54	74	28	50	270	145	82	1.1	1
DBCA5054S	BT50-MD50F-225	54	74	28	50	370	145	182	1.1	1
DBCA5054S	BT50-MD50F-250R	54	74	28	50	395	145	81	1.1	2
DBCA6374S	BT50-MD63F-75	74	100	36	63	255	180	35	1.9	1
DBCA6374S	BT50-MD63F-130	74	100	36	63	310	180	87	1.9	1
DBCA6374S	BT50-MD63F-195	74	100	36	63	375	180	152	1.9	1
DBCA6374S	BT50-MD63F-230	74	100	36	63	410	180	187	1.9	1
DBCA80100S	BT50-MD80F-75	100	136	45	80	290	215	36	3.7	1
DBCA80100S	BT50-MD80F-110	100	136	45	80	325	215	69	3.7	1
DBCA80100S	BT50-MD80F-175	100	136	45	80	390	215	134	3.7	1

➔ Spare Part G67

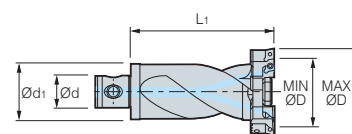
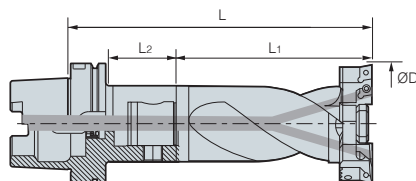
• Head: Basic, Arbor: For separate purchase • Through coolant system installed

* In the above table, the Arbor Model No. is an example model no. and able to adjust the depth of boring with a combination of MD arbors and extension bars. For more details, see the MD arbor page.



HSK-DBC/A

Helical type



Head

(mm)

Designation		Boring range ØD		Ød	Ød ₁	L	L ₁	L ₂	kg
Head	Arbor	Min	Max						
DBCA2528S-H	HSK63A-MD25F-60	38	54	14	25	163	103	31	0.3
DBCA3238S-H	HSK63A-MD32F-65	38	54	18	32	175	110	36	0.5
DBCA5054S-H	HSK63A-MD50F-85	54	74	28	50	230	145	58	1.8
DBCA6374S-H	HSK63A-MD63F-95	74	100	45	80	275	180	69	3.3

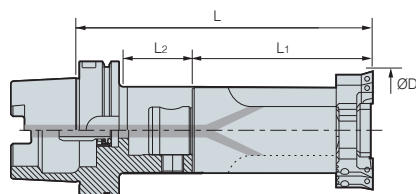
➔ Spare Part **G67**

• Head: Basic, Arbor: For separate purchase • Through coolant system is optional

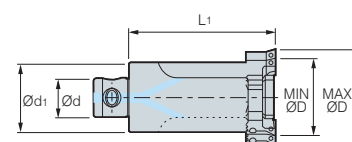
* In the above table, the Arbor Model No. is an example model no. and able to adjust the depth of boring with a combination of MD arbors and extension bars. For more details, see the MD arbor page.

HSK-DBC/A

Straight type



1DIV. = 0.01mm



Head

(mm)

Designation		Boring range ØD		Ød	Ød ₁	L	L ₁	L ₂	kg
Head	Arbor	Min	Max						
DBCA2528S	HSK63A-MD25F-60	38	54	14	25	122	62	31	0.3
DBCA3238S	HSK63A-MD32F-65	38	54	18	32	134.5	69.5	36	0.5
DBCA5054S	HSK63A-MD50F-85	54	74	28	50	179	94	58	1.8
DBCA6374S	HSK63A-MD63F-95	74	100	45	80	100	106.5	69	3.3

➔ Spare Part **G67**

• Head: Basic, Arbor: For separate purchase • Through coolant system is optional

* In the above table, the Arbor Model No. is an example model no. and able to adjust the depth of boring with a combination of MD arbors and extension bars. For more details, see the MD arbor page.

Parts

Designation	For separate purchase
Internal coolant system	

Classification by shank	
HSK50	HSK50A-CNS
HSK63	HSK63A-CNS
HSK100	HSK100A-CNS



BT-DBC

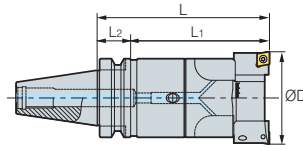


Fig. 1

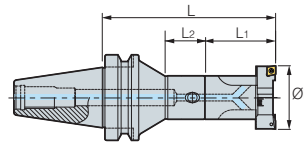
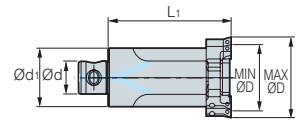


Fig. 2



Head

(mm)

Designation		Boring range ØD		Ød	Ød ₁	L	L ₁	L ₂	kg	Fig.
Head	Arbor	Min	Max							
DBC2528S	BT30-MD25F-90	28	35	14	25	150	60	63	0.3	1
DBC3235S	BT30-MD32F-80	35	46	18	32	145	65	55	0.4	1
DBC4046S	BT30-MD40F-45	46	58	22	40	115	70	22	0.6	1
DBC4046S	BT30-MD40F-60	46	58	22	40	130	70	36	0.6	1
DBC4046S	BT30-MD40F-80	46	58	22	40	140	70	56	0.6	1
DBC5058S	BT30-MD50F-70	58	74	28	50	150	80	48	1.1	1
DBC2528S	BT40-MD25F-95	28	35	14	25	155	60	63	0.3	1
DBC2528S	BT40-MD25F-105R	28	35	14	25	165	60	40	0.3	2
DBC3235S	BT40-MD32F-100	35	46	18	32	165	65	70	0.4	1
DBC3235S	BT40-MD32F-115R	35	46	18	32	180	65	45	0.4	2
DBC4046S	BT40-MD40F-60	46	58	22	40	130	70	31	0.6	1
DBC4046S	BT40-MD40F-110R	46	58	22	40	180	70	60	0.6	2
DBC4046S	BT40-MD40F-115	46	58	22	40	185	70	83	0.6	1
DBC5058S	BT40-MD50F-105	58	74	28	50	185	80	73	1.1	1
DBC6374S	BT40-MD63F-64	74	94	36	63	154	90	37	2.0	1
DBC6374S	BT40-MD63F-110	74	94	36	63	200	90	83	2.0	1
DBC6374S	BT40-MD63F-135	74	94	36	63	225	90	108	2.0	1
DBC8094S	BT40-MD80F-100	94	120	45	80	200	100	73	3.5	1
DBC2528S	BT50-MD25F-105	28	35	14	25	165	60	62	0.3	1
DBC2528S	BT50-MD25F-120R	28	35	14	25	185	60	40	0.3	2
DBC3235S	BT50-MD32F-110	35	46	18	32	175	65	67	0.4	1
DBC3235S	BT50-MD32F-115R	35	46	18	32	180	65	45	0.4	2
DBC3235S	BT50-MD32F-235R	35	46	18	32	300	65	115	0.4	2
DBC4046S	BT50-MD40F-60	46	58	22	40	130	70	22	0.6	1
DBC4046S	BT50-MD40F-195	46	58	22	40	265	70	152	0.6	1
DBC4046S	BT50-MD40F-230R	46	58	22	40	300	70	180	0.6	2
DBC5058S	BT50-MD50F-125	58	74	28	50	205	80	82	1.1	1
DBC5058S	BT50-MD50F-225	58	74	28	50	305	80	182	1.1	1
DBC5058S	BT50-MD50F-250R	58	74	28	50	330	80	81	1.1	2
DBC6374S	BT50-MD63F-75	74	94	36	63	165	90	35	2.0	1
DBC6374S	BT50-MD63F-130	74	94	36	63	220	90	87	2.0	1
DBC6374S	BT50-MD63F-195	74	94	36	63	285	90	152	2.0	1
DBC6374S	BT50-MD63F-230	74	94	36	80	320	90	187	2.0	1
DBC8094S	BT50-MD80F-75	94	120	36	80	175	100	36	3.5	1
DBC8094S	BT50-MD80F-110	94	120	45	80	210	100	69	3.5	1
DBC8094S	BT50-MD80F-175	94	120	45	80	275	100	134	4.5	1
DBC120S	BT50-MD80F-175	120	175	45	80	275	100	134	4.1	1

☞ Spare Part G67

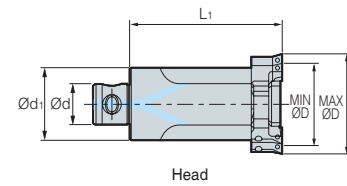
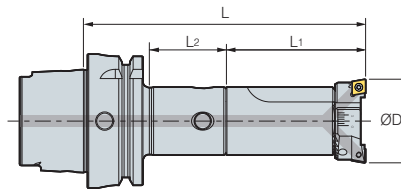
• Head: Basic, Arbor: For separate purchase • Through coolant system installed

* In the above table, the Arbor Model No. is an example model no. and able to adjust the depth of boring with a combination of MD arbors and extension bars. For more details, see the MD arbor page.



HSK-DBC

Modular type



(mm)

Designation		Boring range ØD		Ød	Ød ₁	L	L ₁	L ₂	kg
Head	Arbor	Min	Max						
DBC2528S	HSK63A-MD25F-60	28	35	14	25	120	60	31	0.3
DBC3235S	HSK63A-MD32F-65	35	46	18	32	130	65	36	0.4
DBC4046S	HSK63A-MD40F-70	46	58	22	40	140	70	41	0.6
DBC5058S	HSK63A-MD50F-85	58	74	28	50	165	80	58	1.1
DBC6374S	HSK63A-MD63F-95	74	94	36	63	185	90	69	2.0

➔ Spare Part **G67**

• Head: Basic, Arbor: For separate purchase • Through coolant system is optional

* In the above table, the Arbor Model No. is an example model no. and able to adjust the depth of boring with a combination of MD arbors and extension bars. For more details, see the MD arbor page.

Parts

• DBCA

Basic									
Division	Head	Spring pin	Wrench bolt	Wrench	Cartridge	Set screw	Wrench	Clamp screw	Torx wrench
Parts Designation									
	DBCA2528S	DBCA2528	SP0308	BX0420	LW-3	BCC28-EC	BT0308	LW-1.5	BFTX02506N
DBCA3238S	DBCA3238	SP0410	BX0525	LW-4	BCC38-EC	BT0310	LW-1.5	BFTX02506M	TRX8
DBCA5054S	DBCA5054	SP0616	BX0630	LW-5	BCC54-EC	BT0414	LW-2	BFTX0407N	TRX15
DBCA6374S	DBCA6374	SP1018	BX0635	LW-5	BCC74-EC	BT0520	LW-2.5	BFTX0511N	TRX20
DBCA80100S	DBCA80100	SP1020	BX0840	LW-6	BCC100-EC	BT0625	LW-3	BFTX0511N	TRX20

• DBC

Basic									
Division	Head	Spring pin	Wrench bolt	Wrench	Cartridge	Set screw	Wrench	Clamp screw	Torx wrench
Parts Designation									
	DBC2528S	DBC2528	SP0308	BX0415	LW-3	BCC28	BT0306	LW-1.5	FTKA02565
DBC3235S	DBC3235	SP0410	BX0515	LW-4	BCC35	BT0308			
DBC4046S	DBC4046	SP0516	BX0620	LW-5	BCC46	BT0410	LW-2	FTNA0408	TRX15
DBC5058S	DBC5058	SP0616			BCC58	BT0412			
DBC6374S	DBC6374	SP1018	BX0830	LW-6	BCC74	BT0516	LW-2.5	BFTX0511N	TRX20
DBC8094S	DBC8094	SP1020	BX1035	LW-8	BCC94	BT0620	LW-3		
DBC120S	DBC120N	SP1020	BX0830	LW-6	BCC120	BT0830	LW-4	BFTX0511N	TRX20



BT-SMB

Small Micro Boring Bar

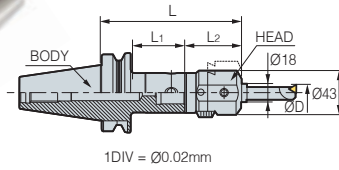


Fig. 1

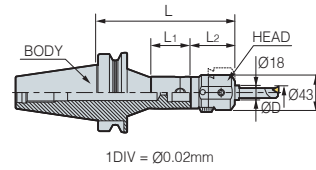
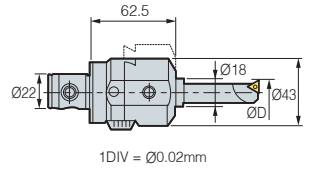


Fig. 2



Head

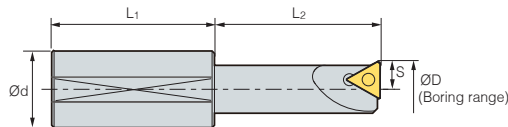
(mm)

Designation			Boring range ØD	L	L ₁	L ₂	kg	Fig.
Head	Arbor	Bite						
SMB4022	BT30-MD40F-45	BB18-□(S)	Ø6.0~Ø34.0	107.5	22	62.5	0.6	1
SMB4022	BT30-MD40F-60	BB18-□(S)	Ø6.0~Ø34.0	122.5	36	62.5	0.6	1
SMB4022	BT30-MD40F-80	BB18-□(S)	Ø6.0~Ø34.0	142.5	56	62.5	0.6	1
SMB4022	BT40-MD40F-60	BB18-□(S)	Ø6.0~Ø34.0	122.5	31	62.5	0.6	1
SMB4022	BT40-MD40F-110R	BB18-□(S)	Ø6.0~Ø34.0	172.5	60	62.5	0.6	2
SMB4022	BT40-MD40F-115	BB18-□(S)	Ø6.0~Ø34.0	177.5	83	62.5	0.6	1
SMB4022	BT50-MD40F-60	BB18-□(S)	Ø6.0~Ø34.0	122.5	22	62.5	0.6	1
SMB4022	BT50-MD40F-195	BB18-□(S)	Ø6.0~Ø34.0	257.5	152	62.5	0.6	1
SMB4022	BT50-MD40F-230R	BB18-□(S)	Ø6.0~Ø34.0	292.5	180	62.5	0.6	2

* Adjustment length: 7 mm

• Head: Basic, Arbor/Bite: For separate purchase • Through coolant system not available

BB Bite (For SMB)



(mm)

Designation	Boring range		Ød	L ₁	L ₂	S	kg	Insert	Insert screw	
	Min	Max								
BB	18-7(S)	7	27	18	30	30	3.5	0.1	TBGT0601□□L	BFTX0204A
	18-9(S)	9	29	18	30	40	4.5	0.1	TPGT0802□□L	BFTX0204A
	18-11(S)	11	31	18	30	45	5.5	0.1	TPGT1103□□L	BFTX0307A
	18-13(S)	13	33	18	40	45	6.5	0.1	TPGT1103□□L	BFTX0307A
	18-15(S)	15	35	18	40	50	7.5	0.2	TPGT1103□□L	BFTX0307A
	18-17(S)	17	37	18	40	50	8.5	0.2	TPGT1103□□L	BFTX0307A

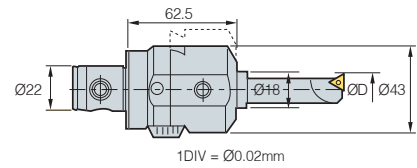
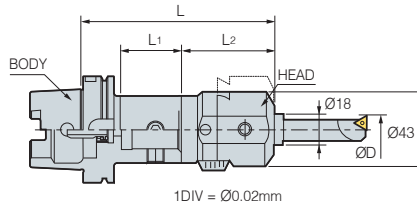
Parts

Basic				For separate purchase	
Division	Boring head	Taper screw	Wrench	Boring bite	Basic holder
Parts					
Designation					
SMB	SMB4022	BTT1013F	LW-2.5	BB18	MD40F



HSK-SMB

Small Micro Boring Bar



Head

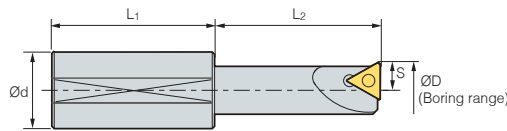
(mm)

Designation			Boring range ØD	L	L ₁	L ₂	
Head	Arbor	Bite					
SMB4022	HSK63A-MD40F - 70	BB18-□(S)	Ø6.0-Ø34.0	132.5	41	62.5	0.6

* Adjustment length: 17 mm

• Head: Basic, Arbor/Bite: For separate purchase • Through coolant system not available

BB Bite (For SMB)



(mm)

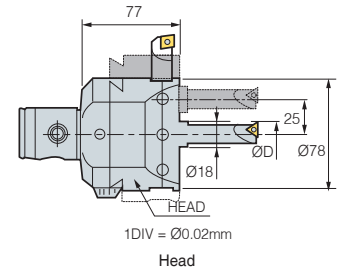
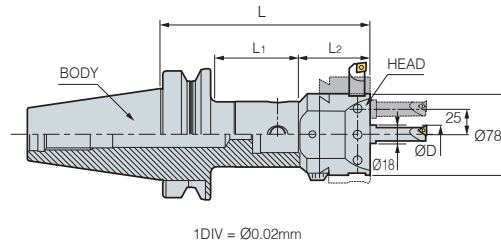
Designation	Boring range		Ød	L ₁	L ₂	S		Insert	Insert screw	
	Min	Max								
BB	18-7(S)	7	27	18	30	30	3.5	0.1	TBGT0601□□L	BFTX0204A
	18-9(S)	9	29	18	30	40	4.5	0.1	TPGT0802□□L	BFTX0204A
	18-11(S)	11	31	18	30	45	5.5	0.1	TPGT1103□□L	BFTX0307A
	18-13(S)	13	33	18	40	45	6.5	0.1	TPGT1103□□L	BFTX0307A
	18-15(S)	15	35	18	40	50	7.5	0.2	TPGT1103□□L	BFTX0307A
	18-17(S)	17	37	18	40	50	8.5	0.2	TPGT1103□□L	BFTX0307A

Parts

Basic				For separate purchase	
Division	Boring head	Taper screw	Wrench	Boring bite	Basic holder
Parts					
Designation					
SMB	SMB4022	BTT1013F	LW-2.5	BB18	MD40F

BT-KMB

Micro Boring



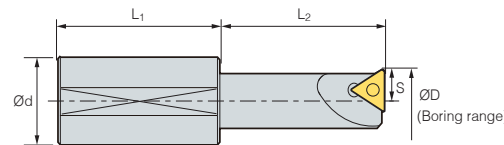
(mm)

Designation			Boring range ØD		L	L1	L2	kg
Head	Arbor	Bite	Bite position	ØD				
KMB6336	BT40-MD63F-64	BB18-□(S)	Center Hole	Ø8.0~Ø38.0	141	37	77	2.2
KMB6336	BT40-MD63F-110	BB18-□(S)	Center Hole	Ø8.0~Ø38.0	187	83	77	2.2
KMB6336	BT40-MD63F-135	BB18-□(S)	Eccentric Hole	Ø41.0~101.0	212	108	77	2.2
KMB6336	BT50-MD63F-75	BB18-□(S)	Eccentric Hole	Ø41.0~101.0	152	35	77	2.2
KMB6336	BT50-MD63F-135	BB18-□(S)	Side Hole	Max.Ø165.0	207	87	77	2.2
KMB6336	BT50-MD63F-195	BB18-□(S)	Side Hole	Max.Ø165.0	272	152	77	2.2

* Adjustment length: 7 mm

• Head: Basic, Arbor/Bite: For separate purchase • Through coolant system not available

BB Bite (For KMB)



(mm)

Designation	Boring range (Center)				Ød	L1	L2	S	kg	Insert	Insert Screw	
	Center	Eccentric										
BB	18-7(S)	7	40	27	91	18	30	30	3.5	0.1	TBGT0601□□L	BFTX0204A
	18-9(S)	9	42	29	93	18	30	40	4.5	0.1	TPGT0802□□L	BFTX0204A
	18-11(S)	11	44	31	95	18	30	45	5.5	0.1	TPGT1103□□L	BFTX0307A
	18-13(S)	13	46	33	97	18	40	45	6.5	0.1	TPGT1103□□L	BFTX0307A
	18-15(S)	15	48	35	99	18	40	50	7.5	0.2	TPGT1103□□L	BFTX0307A
	18-17(S)	17	50	37	101	18	40	50	8.5	0.2	TPGT1103□□L	BFTX0307A

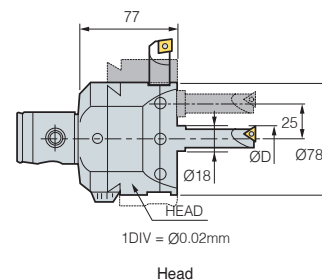
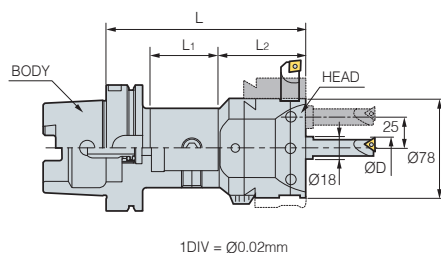
Parts

Basic				For separate purchase	
Division	Boring head	Taper screw	Wrench	Boring bite	Basic holder
Parts					
Designation					
KMB	KMB6336	BTT1620F	LW-4.0	BB18	MD63F



HSK-KMB

Micro Boring



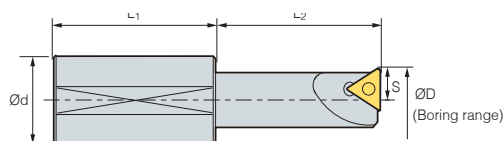
(mm)

Designation			Boring range ØD		L	L ₁	L ₂	kg
Head	Arbor	Bite	Bite position	ØD				
KMB6336	HSK63A-MD63F-95	BB18-□(S)	Center Hole	Ø8.0~Ø38.0	172	69	77	2.2

* Adjustment length: 7 mm

• Head: Basic, Arbor/Bite: For separate purchase • Through coolant system not available

BB Bite (For KMB)



(mm)

Designation	Boring range (Center)				Ød	L ₁	L ₂	S	kg	Insert	Insert Screw	
	Center	Eccentric										
BB	18-7(S)	7	40	27	91	18	30	30	3.5	0.1	TBGT0601□□L	BFTX0204A
	18-9(S)	9	42	29	93	18	30	40	4.5	0.1	TPGT0802□□L	BFTX0204A
	18-11(S)	11	44	31	95	18	30	45	5.5	0.1	TPGT1103□□L	BFTX0307A
	18-13(S)	13	46	33	97	18	40	45	6.5	0.1	TPGT1103□□L	BFTX0307A
	18-15(S)	15	48	35	99	18	40	50	7.5	0.2	TPGT1103□□L	BFTX0307A
	18-17(S)	17	50	37	101	18	40	50	8.5	0.2	TPGT1103□□L	BFTX0307A

Parts

Basic				For separate purchase	
Division	Boring head	Taper screw	Wrench	Boring bite	Basic holder
Parts					
Designation					
KMB	KMB6336	BTT1620F	LW-4.0	BB18	MD63F



BT-SMH

Small Micro Boring Bar (For High precision)

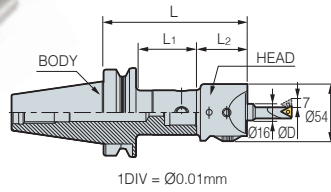


Fig. 1

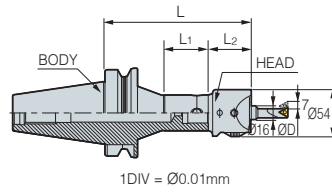
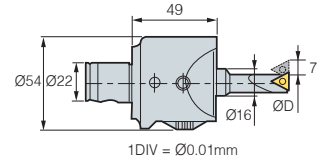


Fig. 2



Head

(mm)

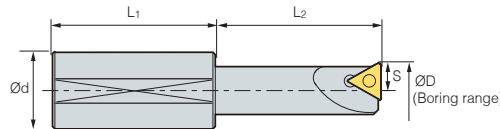
Designation			Boring range ØD	L	L ₁	L ₂	kg	Fig.
Head	Arbor	Bite						
SMH4022	BT30-MD40F-45	BB16-□(S)	Ø6.0~Ø34.0	94	22	49	0.6	1
SMH4022	BT30-MD40F-60	BB16-□(S)	Ø6.0~Ø34.0	109	36	49	0.6	1
SMH4022	BT30-MD40F-80	BB16-□(S)	Ø6.0~Ø34.0	129	56	49	0.6	1
SMH4022	BT40-MD40F-60	BB16-□(S)	Ø6.0~Ø34.0	109	31	49	0.6	1
SMH4022	BT40-MD40F-110R	BB16-□(S)	Ø6.0~Ø34.0	159	60	49	0.6	2
SMH4022	BT40-MD40F-115	BB16-□(S)	Ø6.0~Ø34.0	164	83	49	0.6	1
SMH4022	BT50-MD40F-60	BB16-□(S)	Ø6.0~Ø34.0	109	22	49	0.6	1
SMH4022	BT50-MD40F-195	BB16-□(S)	Ø6.0~Ø34.0	244	152	49	0.6	1
SMH4022	BT50-MD40F-230R	BB16-□(S)	Ø6.0~Ø34.0	279	180	49	0.6	2

* Adjustment length: 7 mm

• Head: Basic, Arbor/Bite: For separate purchase

• Through coolant system not available

BB Bite (For SMH)



(mm)

Designation	Boring range ØD		Ød	L ₁	L ₂	S	Insert	Insert Screw	Wrench	
	Min	Max								
BB	16-5(S)	5	19	16	34	20	2.75	WBG0601□□L	BFTX0203A	TRX06
	16-7(S)	7	21	16	34	30	3.5	TBGT0601□□L	BFTX0204A	TRX06
	16-9(S)	9	23	16	34	40	4.5	TPGT0802□□L	BFTX0204A	TRX06
	16-11(S)	11	25	16	34	45	5.5	TPGT1103□□L	BFTX0307A	TRX10
	16-15(S)	15	29	16	34	50	7.5	TPGT1604□□L	BFTX0307A	TRX10
	16-19(S)	19	33	16	34	60	9.5	TPGT1604□□L	BFTX0410A	TRX15

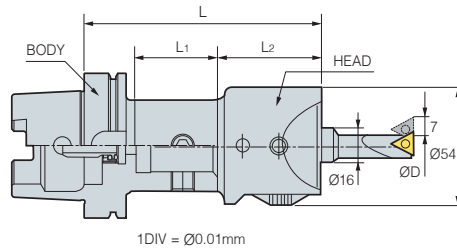
Parts

Basic				For separate purchase	
Division	Boring head	Taper screw	Wrench	Boring bite	Basic holder
Parts					
Designation					
SMH	SMH4022	BTT1013F	LW-3.0	BB16	MD40F



HSK-SMH

Small Micro Boring Bar (For High precision)



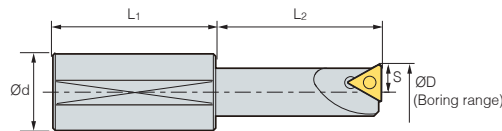
(mm)

Designation			Boring range ØD	L	L ₁	L ₂	
Head	Arbor	Bite					
SMH4022	HSK63-MD40F-70	BB16-□(S)	Ø6.0~Ø34.0	132.5	41	49	0.6

* Adjustment length: 17 mm

• Head: Basic, Arbor/Bite: For separate purchase • Through coolant system not available

BB Bite (For SMH)



(mm)

Designation	Boring range ØD		Insert	Insert Screw		
	Min	Max				
BB	16-7(S)	8	28	TBGT0601□□L	BFTX0204A	0.1
	16-9(S)	10	30	TPGT0802□□L	BFTX0204A	0.1
	16-11(S)	12	32	TPGT1103□□L	BFTX0307A	0.1
	16-13(S)	14	34	TPGT1103□□L	BFTX0307A	0.1
	16-15(S)	16	36	TPGT1604□□L	BFTX0307A	0.2
	16-17(S)	18	38	TPGT1604□□L	BFTX0307A	0.2

Parts

Basic				For separate purchase	
Division	Boring head	Taper screw	Wrench	Boring bite	Basic holder
Parts					
Designation					
SMH	SMH4022	BTT1013F	LW-3.0	BB16	MD40F

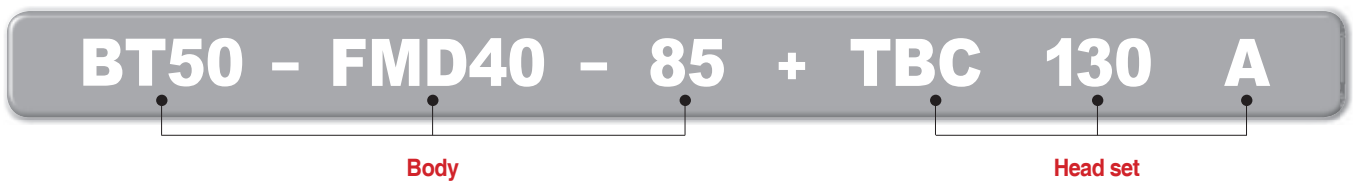
Wide diameter boring system

TBCA new

- Convenience in use simultaneously (available both inside and outside)
- Broad boring diameter and range
- Rough/Finishing boring with replaceable cartridge and common rail
- Boring range for outer diameter: $\varnothing 0\text{--}\varnothing 395$
- Boring range for inner diameter: $\varnothing 130\text{--}\varnothing 631$



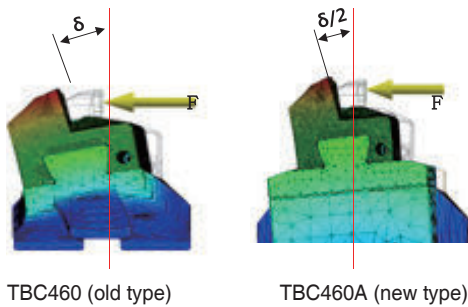
Code system



Features

Reinforced rigidity

- 50% less moment strain (versus the conventional product of DINE)



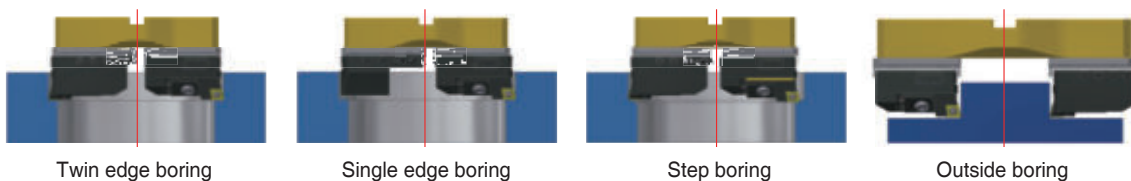
Lightweight design(Head set)

- BCC (Cartridge) + DBR (Bridge) + DBB (Rail)

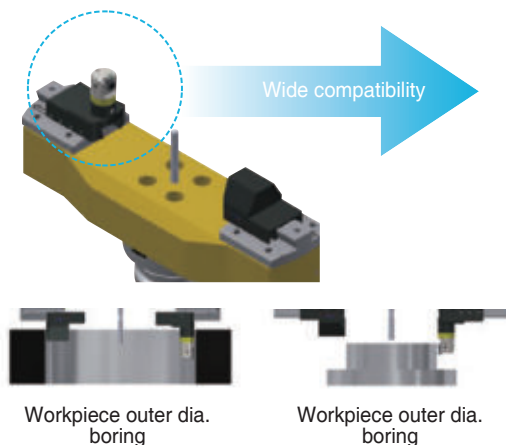


TBC130A	TBC175A	TBC220A	TBC265A
4.2 Kg	5.6 Kg	6.6 Kg	7.5 Kg
TBC310A	TBC385A	TBC460A	TBC535A
9.5 Kg	11.6Kg	14 Kg	16 Kg

Application



Wide compatibility

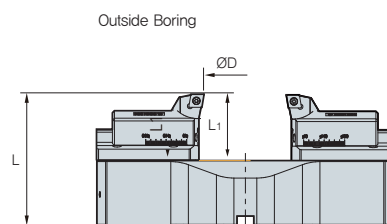
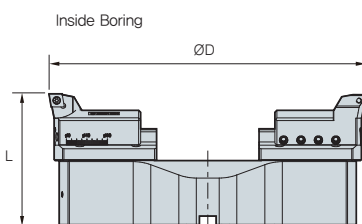


	Images	List of clamping parts	Cutting type
Outer dia. boring		FBH3233B + FCE310 + FCB310	Finishing boring
		DBCA3235S + FCE310 + CB310	Rough boring
Inner dia. boring		DBS□□-□□CA + SCGCL16C-1A2	Rough boring
		FCC310	Finishing boring
		BCC1354	Rough boring

• TBC310A in case

TBCA

Wide diameter boring system



(mm)

FMC Arbor (Individual order)	kg	Twin Edge Boring for Roughing							kg
		TBC Head set (Rail + Cartridge (Main))	L	Boring range ØD					
				Inside Boring		Outside Boring		L ₁	
Min	Max	Min	Max	L ₁					
BT50-FMC40-50	4.6	TBC130A (DBR130 + BCC1348 + BCC1348)	108	130	180	0	35	65	3.8
BT50-FMC40-50	4.6	TBC175A (DBR175 + BCC1348 + BCC1348)	113	175	225	0	75	65	5.2
BT50-FMC40-50	4.6	TBC220A (DBR07015 + BCC1348 + BCC1348)	118	220	270	60	124	65	7.3
BT50-FMC40-50	4.6	TBC265A (DBR07015 + BCC1348 + BCC1348)	123	265	315	64	174	65	7.3
BT50-FMC40-50	4.6	TBC310A (DBR10015 + BCC1345 + BCC1345)	128	310	390	79	159	65	9.7
BT50-FMC40-50	4.6	TBC385A (DBR10015 + BCC1354 + BCC1345)	133	385	465	153	233	65	11.8
BT50-FMC40-50	4.6	TBC460A (DBR10015 + BCC1354 + BCC1345)	138	460	540	229	309	65	14.3
BT50-FMC40-50	4.6	TBC535A (DBR10015 + BCC1354 + BCC1345)	143	535	615	303	383	65	16.4

• TBC Head set: Basic, Arbor: For separate purchase • Through coolant system is optional

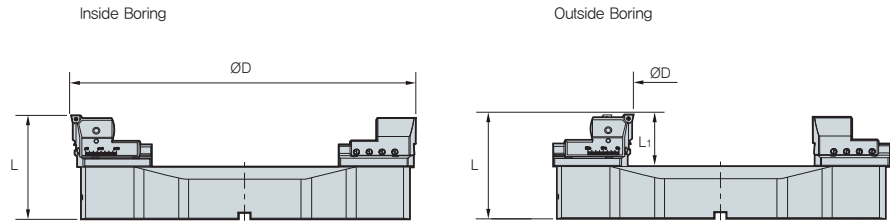
Parts

Head set	Basic		For separate purchase		
	Bridge	Rail	Cartridge	Arbor	Pin
TBC130A	DBB130	DBR130	BCC1348S	BT50-FMC40-50	PN1080
TBC175A	DBB175	DBR175			
TBC220A	DBB220	DBR07015			
TBC265A	DBB265	DBR07015			
TBC310A	DBB310	DBR10015	BCC1354S	BT50-FMC40-50	PN1080
TBC385A	DBB385	DBR10015			
TBC460A	DBB460	DBR10015			
TBC535A	DBB535	DBR10015			



TBCA

Wide diameter boring system



(mm)

FMC Arbor (Individual order)	kg	Single Edge Boring for Roughing							kg
		TBC Head set (Rail + Cartridge (Separate sale))	L	Boring range $\varnothing D$					
				Inside Boring		Outside Boring		L_1	
Min	Max	Min	Max						
BT50-FMC40-50	4.6	TBC130A (DBR130 + FCC130 + FCB130 + FBB33N)	101	130	180	37	37	72	4.4
BT50-FMC40-50	4.6	TBC175A (DBR175 + FCC130 + FCB130 + FBB33N)	106	175	225	80	80	72	5.7
BT50-FMC40-50	4.6	TBC220A (DBR07015 + FCC130 + FCB130 + FBB33N)	111	220	270	173	173	72	7.8
BT50-FMC40-50	4.6	TBC265A (DBR07015 + FCC130 + FCB130 + FBB33N)	116	265	315	176	176	72	7.9
BT50-FMC40-50	4.6	TBC310A (DBR10015 + FCC310 + FCB310 + BB33N)	121	310	390	155.5	155.5	72	10.1
BT50-FMC40-50	4.6	TBC385A (DBR10015 + FCC310 + FCB310 + FBB33N)	126	385	465	229.5	229.5	72	12.2
BT50-FMC40-50	4.6	TBC460A (DBR10015 + FCC310 + FCB310 + FBB33N)	131	460	540	305.5	305.5	72	14.7
BT50-FMC40-50	4.6	TBC535A (DBR10015 + FCC310 + FCB310 + FBB33N)	136	535	615	379.5	379.5	72	16.7

• TBC Head set/Rail: Basic, Arbor/Cartridge: For separate purchase • Through coolant system is optional

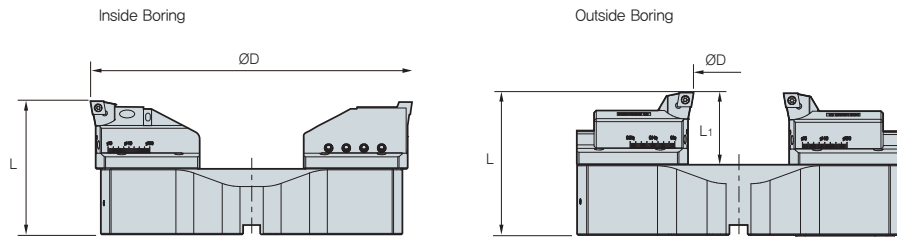
Parts

Basic			For separate purchase				
Head set	Bridge	Rail	Cartridge	Bite	Balance block	Arbor	Pin
TBC130A	DBB130	DBR130	FCC130	FBB130 Δ \square \square	FCB130	BT50-FMC40-50	PN1080
TBC175A	DBB175	DBR175					
TBC220A	DBB220	DBR07015					
TBC265A	DBB265	DBR07015					
TBC310A	DBB310	DBR10015	FCC310		FCB310		
TBC385A	DBB385	DBR10015					
TBC460A	DBB460	DBR10015					
TBC535A	DBB535	DBR10015					



TBCA

Wide diameter boring system



(mm)

FMC Arbor (Individual order)	kg	Step Boring for Roughing								kg
		TBC Head set (Rail + Cartridge (Separate sale))	L	Boring range ØD						
				Inside Boring		Outside Boring				
Min	Max	Min	Max	L ₁						
BT50-FMC40-50	4.6	TBC130A (DBR130 + DBS25-□□CA + SCGCL16CA-12)	108	130	180	0	13.5	65	4.3	
BT50-FMC40-50	4.6	TBC175A (DBR175 + DBS25-□□CA + SCGCL16CA-12)	113	175	225	0	55	65	5.7	
BT50-FMC40-50	4.6	TBC220A (DBR07015 + DBS25-□□CA + SCGCL16CA-12)	118	220	270	64	128	65	7.8	
BT50-FMC40-50	4.6	TBC265A (DBR07015 + DBS25-□□CA + SCGCL16CA-12)	123	265	315	68	118	65	7.9	
BT50-FMC40-50	4.6	TBC310A (DBR10015 + DBS40-□□CA + SCGCL16CA-12)	128	310	390	109	159	65	10.2	
BT50-FMC40-50	4.6	TBC385A (DBR10015 + DBS40-□□CA + SCGCL16CA-12)	133	385	465	183	233	65	12.3	
BT50-FMC40-50	4.6	TBC460A (DBR10015 + DBS40-□□CA + SCGCL16CA-12)	138	460	540	259	309	65	14.8	
BT50-FMC40-50	4.6	TBC535A (DBR10015 + DBS40-□□CA + SCGCL16CA-12)	143	535	615	333	383	65	16.9	

• TBC Head set/Rail: Basic, Arbor/Cartridge: For separate purchase • Through coolant system is optional

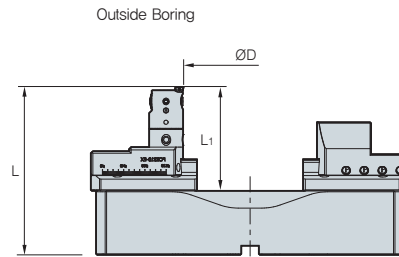
Parts

Basic				For separate purchase				
Head set	Bridge	Rail	Cartridge	Arbor	Slide	Cartridge	Plate	Pin
TBC130A	DBB130	DBR130	BCC1348S	BT50-FMC40-50	DBS25-16CA	ISO Cartridge	ISO Cartridge Plates	PN1080
TBC175A	DBB175	DBR175	BCC1348S		DBS25-20CA			
TBC220A	DBB220	DBR07015	BCC1348S		DBS25-25CA			
TBC265A	DBB265	DBR07015	BCC1348S					
TBC310A	DBB310	DBR10015	BCC1354S					
TBC385A	DBB385	DBR10015	BCC1354S		DBS40-16CA			
TBC460A	DBB460	DBR10015	BCC1354S		DBS40-20CA			
TBC535A	DBB535	DBR10015	BCC1354S		DBS40-25CA			



TBCA

Wide diameter boring system



(mm)

FMC Arbor (Individual order)	kg	Step Boring for Roughing					kg	
		TBC Head set (Rail + Cartridge (Separate sale))		L	Boring range ØD			
					Outside Boring			
Min	Max	L ₁						
BT50-FMC40-50	4.6	TBC130A (DBR130 + FCB130 + FCE130 + FBH3233B + FBB33N)		145	0	39	102	5.2
BT50-FMC40-50	4.6	TBC175A (DBR175 + FCB130 + FCE130 + FBH3233B + FBB33N)		150	0	84	102	6.5
BT50-FMC40-50	4.6	TBC220A (DBR07015 + FCB130 + FCE130 + FBH3233B + FBB33N)		155	26	180	102	8.7
BT50-FMC40-50	4.6	TBC265A (DBR07015 + FCB130 + FCE130 + FBH3233B + FBB33N)		160	26	180	102	8.7
BT50-FMC40-50	4.6	TBC310A (DBR10015 + FCB310 + FCE310 + FBH3233B + FBB33N)		165	16	170	102	11
BT50-FMC40-50	4.6	TBC385A (DBR10015 + FCB310 + FCE310 + FBH3233B + FBB33N)		170	90	244	102	13.1
BT50-FMC40-50	4.6	TBC460A (DBR10015 + FCB310 + FCE310 + FBH3233B + FBB33N)		175	166	318	102	15.6
BT50-FMC40-50	4.6	TBC535A (DBR10015 + FCB310 + FCE310 + FBH3233B + FBB33N)		180	240	394	102	17.7

• TBC Head set/Rail: Basic, Arbor/Cartridge: For separate purchase • Through coolant system is optional

Parts

Basic			For separate purchase				
Head set	Bridge	Rail	Arbor	Slide	B/B	Head	Pin
TBC130A	DBB130	DBR130					
TBC175A	DBB175	DBR175					
TBC220A	DBB220	DBR07015					
TBC265A	DBB265	DBR07015					
TBC310A	DBB310	DBR10015					
TBC385A	DBB385	DBR10015					
TBC460A	DBB460	DBR10015					
TBC535A	DBB535	DBR10015					

• B/B: Balance Block



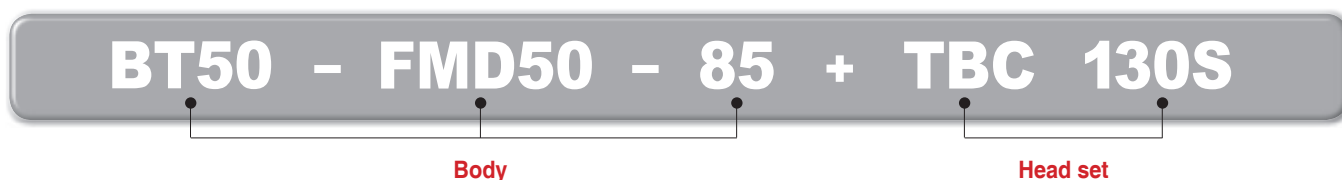
Balance cut tool for Rough boring

TBC

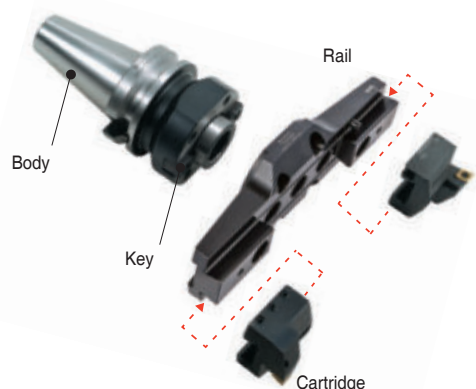
- Wide boring range for big diameters: Ø130~Ø540 mm
- Stable structure against for cutting load - Assembly by dove-tail structure
- Interconvert with FBC
 - Common boring head and rail adopted, different cartridge
- Light-weight (5%~20% reduced)
- Various cartridge approach angle: 15°, 45°



Code system



TBC boring tool structure & features

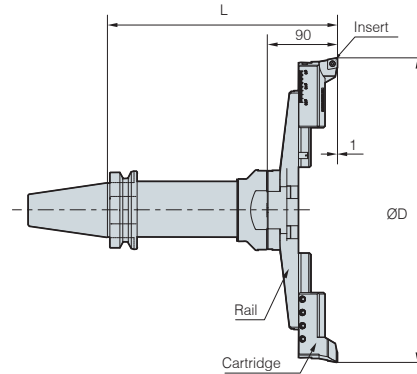


Boring range

Grade	Dia (Ø)		Head set	Insert
	Min	Max		
TBC130	130	180	TBC130 (TBR130 + BCC1348 + BCC1348)	CCMT1204□□
TBC175	175	225	TBC175 (TBR175 + BCC1348 + BCC1348)	CCMT1204□□
TBC220	220	270	TBC220 (TBR220 + BCC1348 + BCC1348)	CCMT1204□□
TBC265	265	315	TBC265 (TBR265 + BCC1348 + BCC1348)	CCMT1204□□
TBC310	310	390	TBC310 (TBR310 + BCC1348 + BCC1348)	CCMT1204□□
TBC385	385	465	TBC385 (TBR310 + BCC1348 + BCC1348)	CCMT1204□□
TBC460	460	540	TBC460 (TBR460 + BCC1348 + BCC1348)	CCMT1204□□

BT-TBC

Balance cut tool for rough boring



(mm)

FMC Arbor (Individual order)	kg	Rough boring (TBC)				
		TBC Head set (Rail + Cartridge)	L	Boring range ØD		kg
				Min	Max	
BT50-FMD50-85	5.9	TBC130 (TBR130 + BCC1348)	175	130	180	3.2
BT50-FMD50-155	7.9	TBC130 (TBR130 + BCC1348)	245	130	180	3.2
BT50-FMD50-205	9.7	TBC130 (TBR130 + BCC1348)	295	130	180	3.2
BT50-FMD50-255	13.4	TBC130 (TBR130 + BCC1348)	345	130	180	3.2
BT50-FMD50-85	5.9	TBC175 (TBR175 + BCC1348)	175	175	225	3.6
BT50-FMD50-155	7.9	TBC175 (TBR175 + BCC1348)	245	175	225	3.6
BT50-FMD50-205	9.7	TBC175 (TBR175 + BCC1348)	295	175	225	3.6
BT50-FMD50-255	13.4	TBC175 (TBR175 + BCC1348)	345	175	225	3.6
BT50-FMD50-85	5.9	TBC220 (TBR220 + BCC1348)	175	220	270	4
BT50-FMD50-155	7.9	TBC220 (TBR220 + BCC1348)	245	220	270	4
BT50-FMD50-205	9.7	TBC220 (TBR220 + BCC1348)	295	220	270	4
BT50-FMD50-255	13.4	TBC220 (TBR220 + BCC1348)	345	220	270	4
BT50-FMD50-85	5.9	TBC265 (TBR265 + BCC1348)	175	265	315	4.2
BT50-FMD50-155	7.9	TBC265 (TBR265 + BCC1348)	245	265	315	4.2
BT50-FMD50-205	9.7	TBC265 (TBR265 + BCC1348)	295	265	315	4.2
BT50-FMD50-255	13.4	TBC265 (TBR265 + BCC1348)	345	265	315	4.2
BT50-FMD50-85	5.9	TBC310 (TBR310 + BCC1354)	175	310	390	5.2
BT50-FMD50-155	7.9	TBC310 (TBR310 + BCC1354)	245	310	390	5.2
BT50-FMD50-205	9.7	TBC310 (TBR310 + BCC1354)	295	310	390	5.2
BT50-FMD50-255	13.4	TBC310 (TBR310 + BCC1354)	345	310	390	5.2
BT50-FMD50-85	5.9	TBC385 (TBR385 + BCC1354)	175	385	465	5.5
BT50-FMD50-155	7.9	TBC385 (TBR385 + BCC1354)	245	385	465	5.5
BT50-FMD50-205	9.7	TBC385 (TBR385 + BCC1354)	295	385	465	5.5
BT50-FMD50-255	13.4	TBC385 (TBR385 + BCC1354)	345	385	465	5.5
BT50-FMD50-85	5.9	TBC460 (TBR460 + BCC1354)	175	460	540	12.5
BT50-FMD50-155	7.9	TBC460 (TBR460 + BCC1354)	245	460	540	12.5
BT50-FMD50-205	9.7	TBC460 (TBR460 + BCC1354)	295	460	540	12.5
BT50-FMD50-255	13.4	TBC460 (TBR460 + BCC1354)	345	460	540	12.5

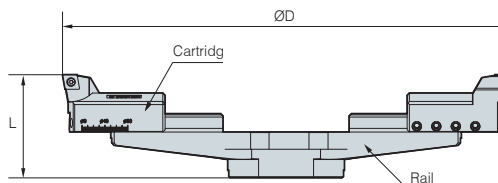
➔ Spare Part G81

• TBC Head set: Basic, Arbor: For separate purchase • Through coolant system is not available



TBC Head Set

Balance cut tool for rough boring



(mm)

Head set (Main component)			Boring range ØD		L	kg	For separate purchase
Designation	Rail	Cartridge	Min	Max			Insert
TBC130S	TBR130	BCC1348	130	180	90	3.5	CCMT1204□□
TBC175S	TBR175	BCC1348	175	225	90	3.9	CCMT1204□□
TBC220S	TBR220	BCC1348	220	270	90	4.3	CCMT1204□□
TBC265S	TBR265	BCC1348	265	315	90	4.5	CCMT1204□□
TBC310S	TBR310	BCC1354	310	390	90	5.5	CCMT1204□□
TBC385S	TBR385	BCC1354	385	465	90	5.8	CCMT1204□□
TBC460S	TBR460	BCC1354	460	540	90	12.8	CCMT1204□□

* If CNMG1204□□ insert is used, BCN1348, BCN1354 cartridges can be ordered.

Parts

Basic							
Division	Rail	Cartridge	Clamp bolt	Clamp bolt	Hexagonal wrench	Clamp screw	Torx wrench
Parts Head set							
	TBC130S	TBR130	BX0820	BT0645	LW-3 LW-4 LW-6	BFTX0511N	TRX20
	TBC175S	TBR175					
	TBC220S	TBR220					
	TBC265S	TBR265	BCC1354 (BCN1354)	BT0660			
	TBC310S	TBR310					
	TBC385S	TBR385					
TBC460S	TBR460						



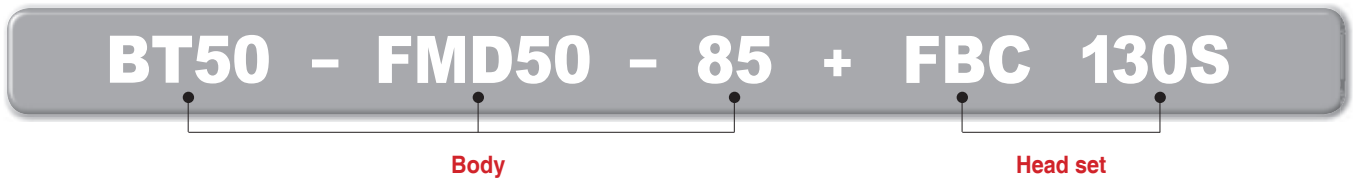
Balance cut tool for fine boring

FBC

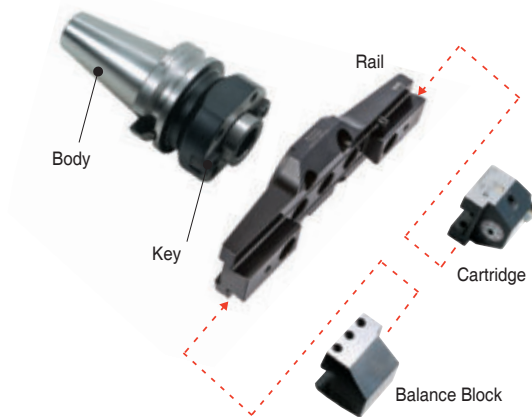
- Broad boring diameter and range
 - Wide Boring Range: Ø130~Ø540 mm
- Structurally stable enough to resist cutting load
 - Provides strong cutting performance based on the precision grinding dovetail method
- Can perform rough boring operation by changing boring head cartridges
 - Compatible boring head and rail as they are in the same structure
- Various cartridge tip angles
 - cartridge fore end angles 15° and 45° selectable



Code system



FBC boring tool structure & features



- Cartridge: FCC130
- Balance Block: FCB130
- Insert:
 - CCGT09T3□□
 - CCMT1204□□
 - TPGT1103□□

Boring range

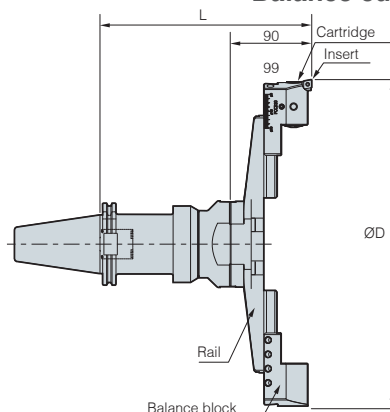
Designation	Dia (Ø)		Head set	Insert
	Min	Max		
FBC130	130	180	FBC130S (TBR130 + FCC130 + FCB130)	FBB130-C09 (CCMT09T3□□, CCGT09T3□□) FBB130-C12 (CCMT1204□□) FBB130-T11 (TPMT1103□□,TPGT1103□□L)
FBC175	175	225	FBC175S (TBR175 + FCC130 + FCB130)	
FBC220	220	270	FBC220S (TBR220 + FCC130 + FCB130)	
FBC265	265	315	FBC265S (TBR265 + FCC130 + FCB130)	
FBC310	310	390	FBC310S (TBR310 + FCC310 + FCB310)	
FBC385	385	465	FBC385S (TBR385 + FCC310 + FCB310)	
FBC460	460	540	FBC460S (TBR460 + FCC310 + FCB310)	



BT-FBC



Balance cut tool for fine boring



(mm)

FMC Arbor (Individual order)	kg	Rough boring (TBC)				
		TBC Head set (Rail + Cartridge + Balance block)	L	Boring range (ØD)		kg
				Min	Max	
BT50-FMD50-85	5.9	FBC130S (TBR130 + FCC130 + FCB130)	182	130	180	3.7
BT50-FMD50-155	7.9	FBC130S (TBR130 + FCC130 + FCB130)	252	130	180	3.7
BT50-FMD50-205	9.7	FBC130S (TBR130 + FCC130 + FCB130)	302	130	180	3.7
BT50-FMD50-255	13.4	FBC130S (TBR130 + FCC130 + FCB130)	352	130	180	3.7
BT50-FMD50-85	5.9	FBC175S (TBR175 + FCC130 + FCB130)	182	175	225	4.1
BT50-FMD50-155	7.9	FBC175S (TBR175 + FCC130 + FCB130)	252	175	225	4.1
BT50-FMD50-205	9.7	FBC175S (TBR175 + FCC130 + FCB130)	302	175	225	4.1
BT50-FMD50-255	13.4	FBC175S (TBR175 + FCC130 + FCB130)	352	175	225	4.1
BT50-FMD50-85	5.9	FBC220S (TBR220 + FCC130 + FCB130)	182	220	270	4.5
BT50-FMD50-155	7.9	FBC220S (TBR220 + FCC130 + FCB130)	252	220	270	4.5
BT50-FMD50-205	9.7	FBC220S (TBR220 + FCC130 + FCB130)	302	220	270	4.5
BT50-FMD50-255	13.4	FBC220S (TBR220 + FCC130 + FCB130)	352	220	270	4.5
BT50-FMD50-85	5.9	FBC265S (TBR265 + FCC130 + FCB130)	182	265	315	4.7
BT50-FMD50-155	7.9	FBC265S (TBR265 + FCC130 + FCB130)	252	265	315	4.7
BT50-FMD50-205	9.7	FBC265S (TBR265 + FCC130 + FCB130)	302	265	315	4.7
BT50-FMD50-255	13.4	FBC265S (TBR265 + FCC130 + FCB130)	352	265	315	4.7
BT50-FMD50-85	5.9	FBC310S (TBR310 + FCC310 + FCB310)	182	310	390	5.5
BT50-FMD50-155	7.9	FBC310S (TBR310 + FCC310 + FCB310)	252	310	390	5.5
BT50-FMD50-205	9.7	FBC310S (TBR310 + FCC310 + FCB310)	302	310	390	5.5
BT50-FMD50-255	13.4	FBC310S (TBR310 + FCC310 + FCB310)	352	310	390	5.5
BT50-FMD50-85	5.9	FBC385S (TBR385 + FCC310 + FCB310)	182	385	465	5.8
BT50-FMD50-155	7.9	FBC385S (TBR385 + FCC310 + FCB310)	252	385	465	5.8
BT50-FMD50-205	9.7	FBC385S (TBR385 + FCC310 + FCB310)	302	385	465	5.8
BT50-FMD50-255	13.4	FBC385S (TBR385 + FCC310 + FCB310)	352	385	465	5.8
BT50-FMD50-85	5.9	FBC460S (TBR460 + FCC310 + FCB310)	182	460	540	12.8
BT50-FMD50-155	7.9	FBC460S (TBR460 + FCC310 + FCB310)	252	460	540	12.8
BT50-FMD50-205	9.7	FBC460S (TBR460 + FCC310 + FCB310)	302	460	540	12.8
BT50-FMD50-255	13.4	FBC460S (TBR460 + FCC310 + FCB310)	352	460	540	12.8

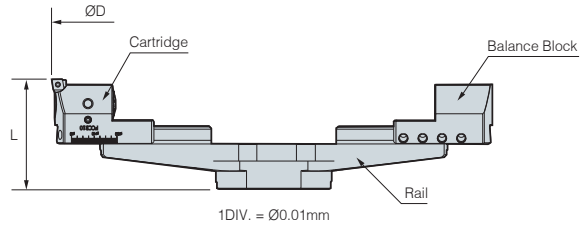
➔ Spare Part **G84**

• TBC Head set: Basic, Arbor: For separate purchase • Through coolant system not available



FBC Head Set

Balance cut tool for fine boring



(mm)

Head set (Main component)				Boring range ØD		L	Kg	For separate purchase
Designation	Rail	Cartridge	Balance block	Min	Max			Bite
TBC130S	TBR130	FCC130	FCB130	130	180	97	3.8	FBB130-C09 FBB130-C12 FBB130-T11
TBC175S	TBR175	FCC130	FCB130	175	225	97	4.1	
TBC220S	TBR220	FCC130	FCB130	220	270	97	4.5	
TBC265S	TBR265	FCC130	FCB130	265	315	97	4.6	
TBC310S	TBR310	FCC310	FCB310	310	390	97	5.5	
TBC385S	TBR385	FCC310	FCB310	385	465	97	5.8	
TBC460S	TBR460	FCC310	FCB310	460	540	97	12.8	

Parts

Basic							For separate purchase
Division	Rail	Cartridge	Balance block	Clamp bolt	Clamp bolt	Hexagonal wrench	Bite
Parts Head set							
	FBC130S	TBR130	FCC130	FCB130	BTF0810 BTF0814	LW-3 LW-4	FBB130-C09 FBB130-C12 FBB130-T11
	FBC175S	TBR175					
	FBC220S	TBR220					
	FBC265S	TBR265					
	FBC310S	TBR310	FCC310	FCB310		BT0660	
	FBC385S	TBR385					
	FBC460S	TBR460					

FBB Bite



Designation	Insert
FBB130 - C09	CCMT09T3□□, CCGT09T3□□
C12	CCMT1204□□
T11	TPMT1103□□, TPGT1103□□



Slim Angular Head

BT-SAHA

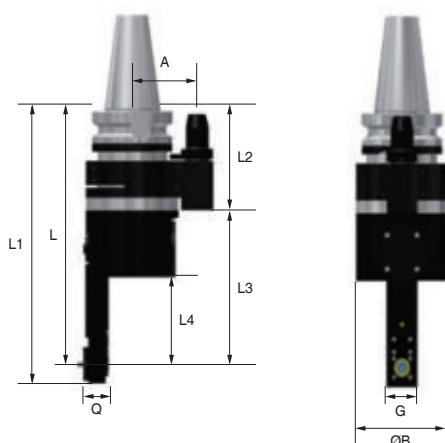
- Angular head for narrow inside boring
(min. inner diameter of workpiece: $\varnothing 40$, min. boring width: 32 mm)
- MAX 3,500 RPM, Spindle: applied rotation ratio = 1:1.37
- Boring range: $\varnothing 3$, $\varnothing 4$, $\varnothing 6$



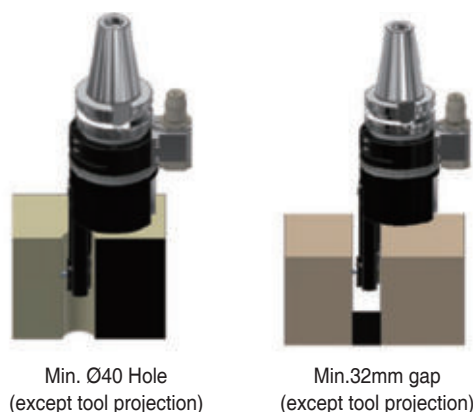
Code system



Details



Machining Features




Designation	L	L1	L2	L3	L4	A	Q	G	ØB	Rotation ratio (IN:OUT)	Rotation direction	MAX RPM	kg
BT50-SAHA6-277	277	298	183.5	166.5	93.5	80 (110)	31.5	40	76	1:1.37	CW:CW	3,500	14

Clamping Force

Division	Measurement	Measured value (N-m)			
Clamp torque	2	2.5	3	3.5	4
Clamping Force	Not measurable	5.5	6.5	7	7

※ The moderate clamp torque of collet is 3.5N-m.

Exclusive collet

	Designation	Clamping range
	SAH6-C3	3
	SAH6-C4	4
	SAH6-C6	6

How to clamp



1. Couple the tool with SAH dedicated collet
2. Insert the coupled tool into SAH and fix it with a dedicated tightening jig
3. Turn the bolt using a hexagonal wrench

G Angular head

ANGULAR HEAD

ANGULAR HEAD

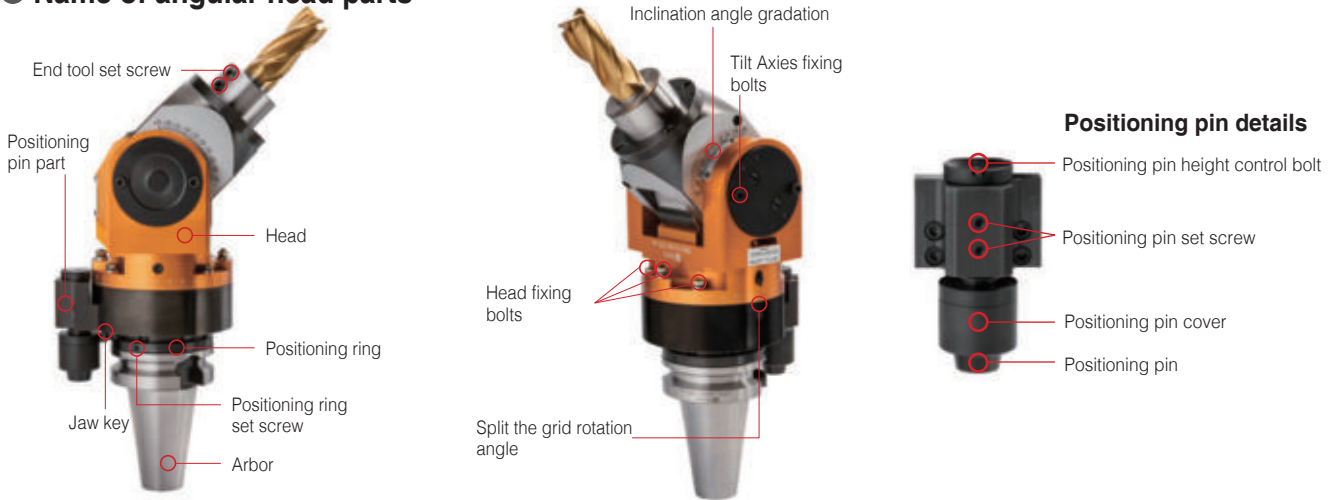
- Doubled effect by one equipment/Available for various angles
- Lighter aluminum body



Code system



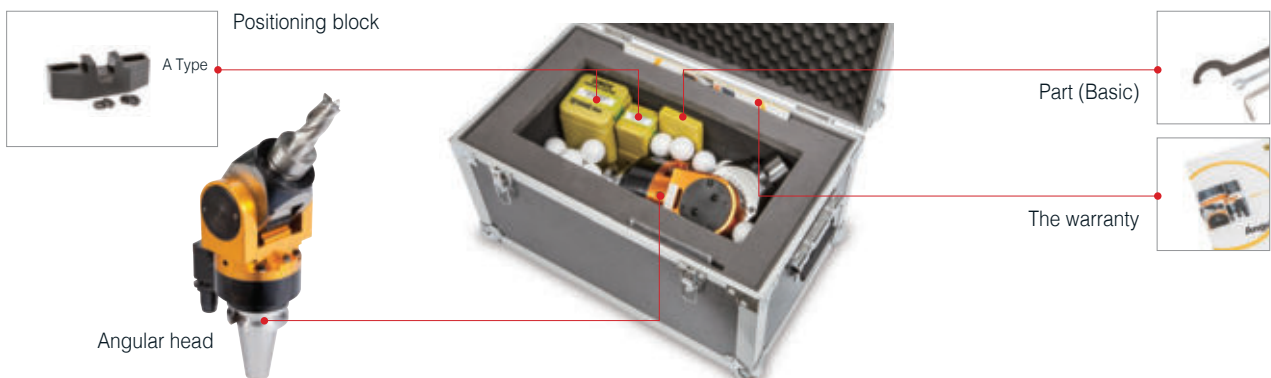
Name of angular head parts



Various applications

0-90-degree rotating (MAH, KHU)	Fixed 90-degree type (KAH)	Fixed 45-degree type (KAC)	Attachment type (HRAG, KAG)

Components



MAH

Universal type MAH (Reinforced series)

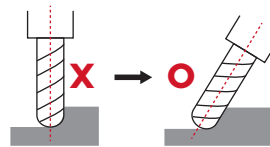
- Reinforced type Better performance by improving existing universal Angular head
 - Stability on large mold machining
 - Use 32mm Ball Endmill



KHU

Universal type KHU (Free angle)

- Adjustable angle-type angular head that enables flexible machining
 - Wide vertical (0° ~ 90°) and horizontal (0° ~ 360°) machining angle range
 - To use Tap-exclusive collet, please contact us in advance
 - HSK and SK types are customizable



Be sure to give a slope to the cutting edge of a ball end mill when machining it as the ball end mill edge is worn out and the surface roughness of the workpiece becomes defective

HRAG

Attachment type HRAG (Reinforced type)

- HRAG: The reinforced bracket enhanced durability upto 200%
 - Stability on face milling machining
 - Enhances compatibility with the machining device due to easy bracket disassembly/assembly even on the BT50 shank
 - Improves product life cycle



KAG

Attachment type KAG

- Free 360° angle adjusting from side to side
 - Possible to use various tools of BT40 and BT30
 - HSK and SK type are order made
 - Coolant types are to be ordered separately



KAH

Modular type KAH (90° type)

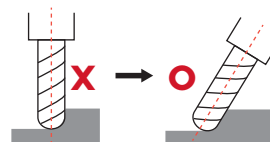
- Adjustable angle-type angular head that enables flexible machining
 - Adjusting angle up to 360°
 - To use Tap-exclusive Collet, please contact us in advance
 - HSK and SK type are order made



KAC

Modular type KAC (45° type)

- Fixed angle type angular head that enables flexible machining
 - Adjusting angle up to 360°
 - To use Tap-exclusive Collet, please contact us in advance
 - 45-degree fixed type angular head
 - For BT40 types, please contact us separately

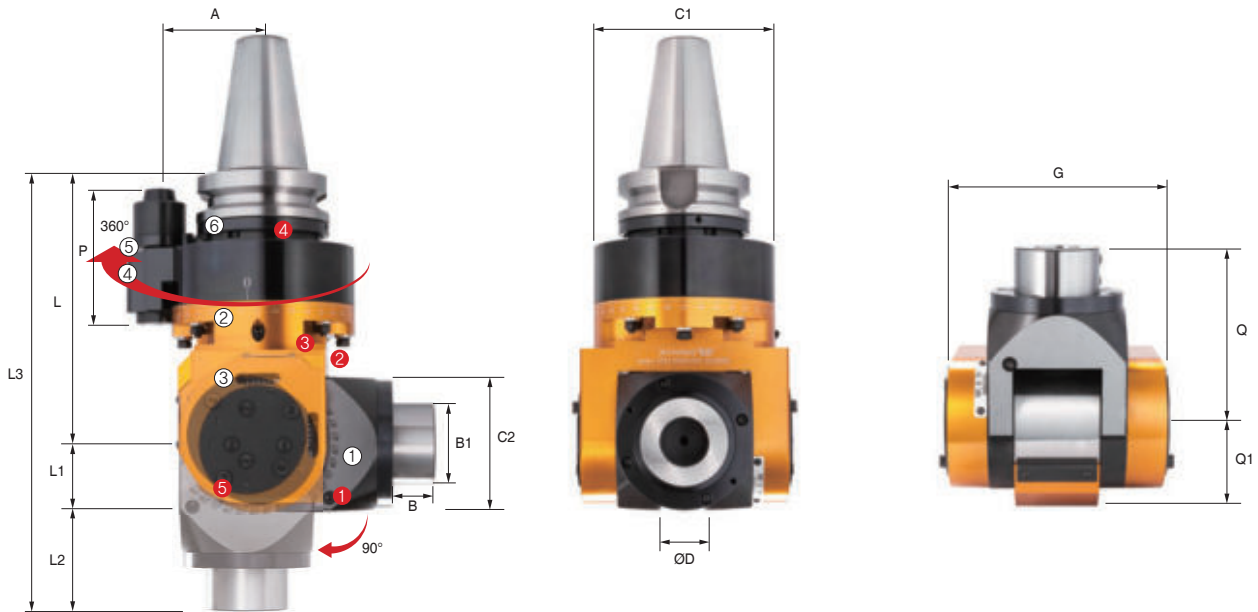


Be sure to give a slope to the cutting edge of a ball end mill when machining it as the ball end mill edge is worn out and the surface roughness of the workpiece becomes defective

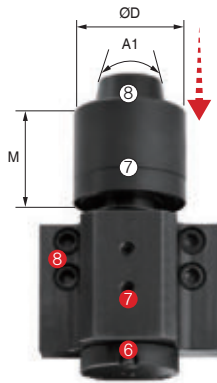
G Angular Head

MHA for mold (0°~90°)_Reinforced type

BT-MAH



Positioning pin



Shank size	M	A1	ØD
BT50	56.5	20°	Ø40

NO	Name
①	Inclination angle gradation (Axial positioning in 0°~90°)
②	Rotating angle gradation (Free radius position in 360°)
③	Head
④	Positioning pin part
⑤	Jaw key
⑥	Positioning ring
⑦	Positioning pin cover
⑧	Positioning pin

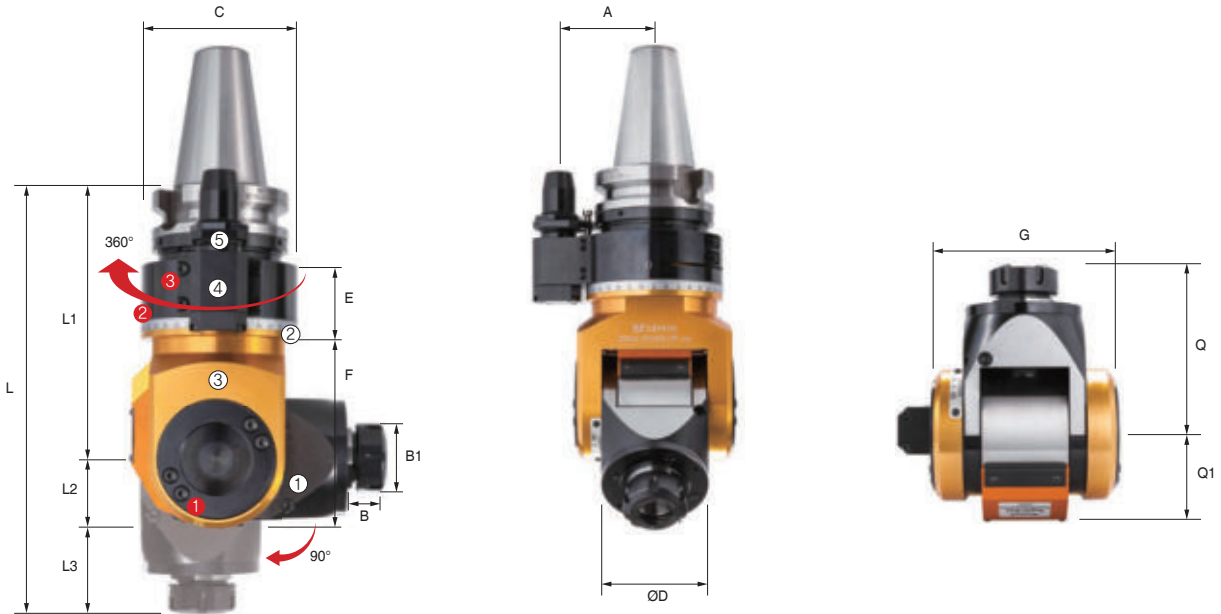
NO	Part name	Designation
①	Inclination angle gradation screw	BT1216
②	Head fixed bolts	BT0645
③	Rotating angle gradation screw	BT0640
④	Positioning ring set screw	MSST5-12
⑤	Tilt Axes fixing bolt	BH0616
⑥	Positioning pin height control bolt	BT0516
⑦	Positioning pin set screw	BT0512
⑧	Body position block set screw	BX0516

Designation	ØD	L	L1	L2	L3	C	C1	G	C2	Q	Q1	B	B1	P	A	Max RPM	Install tool	kg
BT50-MAH32-200	32	200	47	78	325	136	95	154	95	125	63	31	60	95	80	3,000	SIDE LOCK	19.6

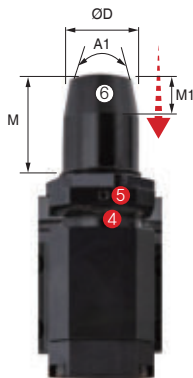


KHU (0°~90°)_Collet type

BT-KHU



Positioning pin



Shank size	M	M1	A	ØD
BT40	Max: 32 Min: 26	10	20°	Ø19.6

NO	Name
①	Inclination angle gradation (Axial positioning in 0°~90°)
②	Rotating angle gradation (Free radius position in 360°)
③	Head
④	Positioning pin part
⑤	Jaw key
⑥	Height control wrench hole

NO	Part name	Designation
①	Tilt Axes fixing bolt	BH0630
②	Bracket angle fixing bolt	BX0630
③	Position block fixing bolt	BX0512
④	Set screw	BT0404
⑤	Fixing bolts	BX05630

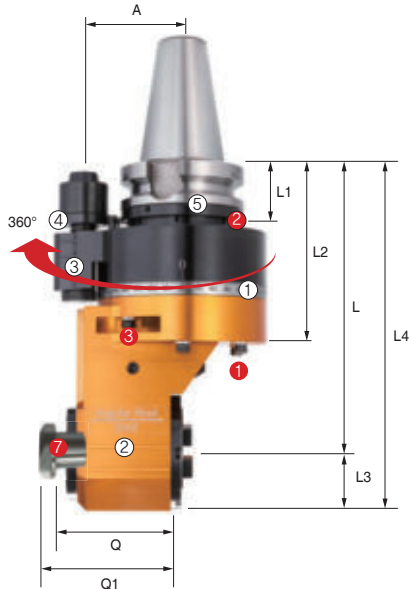
Designation	ØD	ØD1	L	L1	L2	L3	B	B1	E	F	C	A	G	Q	Q1	Torque rate (IN:OUT)	Direction of rotation (IN:OUT)	Max RPM	Collet	kg
BT40-KHU10-160	1.0~10.0	58	247	160	33	54	22	28	51	98	96	65	90	87	40	1:2	CW:CW	6,000	GER16	8.3
BT50-KHU10-180	1.0~10.0	84	267	180	33	54	22	28	53	103	114	80	90	87	40	1:2	CW:CW	6,000	GER16	11.5
BT50-KHU20-195	1.0~20.0	84	315	195	47	73	29	50	53	132	114	80	124	120	63	1:1	CW:CW	3,000	GER32	17.9



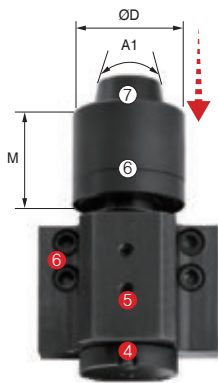
G Angular Head

HRAG (90° fixed)_Reinforced type

BT-HRAG



Positioning pin



Shank size	M	A1	ØD
BT50	56.5	20°	Ø40

NO	Name
①	Rotating angle graduation (Free radius position in 360°)
②	Head
③	Positioning pin part
④	Jaw key
⑤	Positioning ring
⑥	Positioning pin cover
⑦	Positioning pin

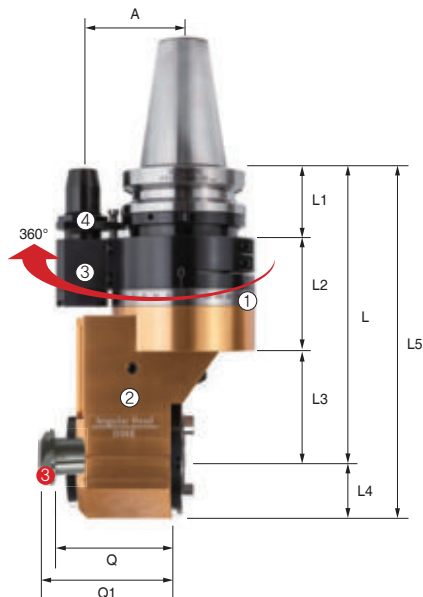
NO	Part name	Designation
①	Head fixed bolts	BX0660
②	Positioning ring set screw	MSST5-12
③	Rotating angle graduation screw	BT0648
④	Positioning pin height control bolt	BT0516
⑤	Positioning pin set screw	BT0512
⑥	Body position block set screw	BX0516
⑦	BT/NT Bolt	

Designation	L	L1	L2	L3	L4	Q	Q1	A	G	G1	Max RPM	Tool shank	kg
BT50-HRAG40-230	230	56.5	145	46.5	276.5	89	101	80	93	136	3000	BT/NT40	18.2

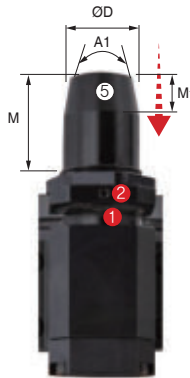


KAG (90° fixed type)

BT-KAG



Positioning pin



Shank size	M	M1	A1	ØD
BT40	Max: 32 Min: 26	10	20°	Ø19.6
BT50	Max: 35 Min: 29	15	20°	Ø28

NO	Name
①	Rotating angle graduation (Free radius position in 360°)
②	Head
③	Positioning pin part
④	Jaw key
⑤	Height control wrench hole

NO	Part name	Designation
①	Set screw	BT0404
②	Fixing bolts	BX50630
③	BT / NT Bolt	

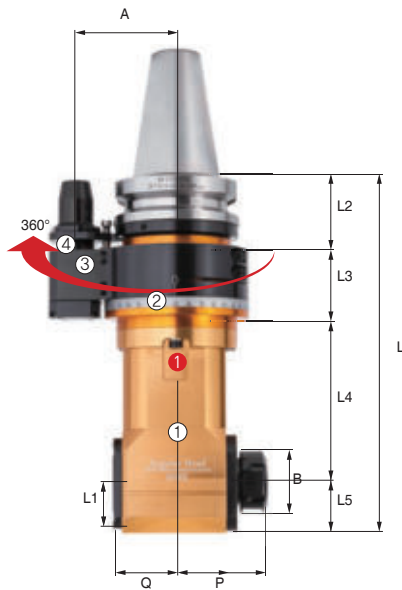
Designation	L	L1	L2	L3	L4	L5	Q	Q1	A	C	G	Torque rate (IN:OUT)	Direction of rotation (IN:OUT)	MAX RPM	Holder shank	kg
BT40-KAG30-195	195	44	86	65	37.5	232.5	66	70	65	96	75	1:1	CW:CW	4,000	BT30/NT30	6.4
BT50-KAG40-230	230	57	88	85	46.5	276.5	89	94	80	114	93	1:1	CW:CW	3,000	BT40/NT40	15.8



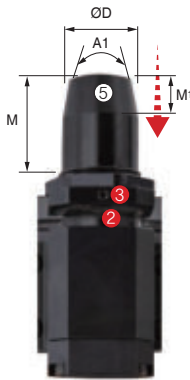
G Angular Head

HRAG (90° fixed)_Collet type

BT-KAH



Positioning pin



Shank size	M	M1	A1	ØD
BT40	Max: 32 Min: 26	10	20°	Ø19.6
BT50	Max: 35 Min: 29	15	20°	Ø28

NO	Name
①	Head
②	Rotating angle graduation (Free radius position in 360°)
③	Positioning pin part
④	Jaw key
⑤	Height control wrench hole

NO	Part name	Designation
①	Head fixing bolts	BX0618
②	Set screw	BT0404
③	Fixing bolts	BX50630

Designation	ØD	L	L1	L2	L3	L4	L5	B	A	P	Q	G	G1	Torque rate (IN:OUT)	Max RPM	Collet	kg
BT40-KAH7-170	1.0~7.0	190	20	44	71	55	20	19	65	37	24.5	40	96	1:1	5,000	GER11	4.6
BT40-KAH10-195	1.0~10.0	220	25	44	71	80	25	28	65	46	32	58	96	1:1	5,000	GER16	5.8
BT40-KAH13-165	1.0~13.0	193	28	44	71	50	28	35	65	53	35	60	96	1:1	5,000	GER20	5.7
BT40-KAH20-180	2.0~20.0	218	38	44	71	65	38	50	65	71	49	76	96	1:1	3,500	GER32	6.7
BT50-KAH07-220	1.0~7.0	240	20	57	54	109	20	19	80	37	24.5	40	96	1:1	5,000	GER11	9.8
BT50-KAH10-215	1.0~10.0	240	25	57	54	104	25	28	80	46	32	58	96	1:1	5,000	GER16	10.7
BT50-KAH10-260	1.0~10.0	285	25	57	54	149	25	28	80	46	32	58	96	1:1	5,000	GER16	11.0
BT50-KAH13-260	1.0~13.0	288	28	57	54	149	28	35	80	53	35	60	96	1:1	5,000	GER20	11.2
BT50-KAH20-200	2.0~20.0	238	38	57	54	89	38	50	80	71	49	76	96	1:1	3,500	GER32	11.6
BT50-KAH20-240	2.0~20.0	278	38	57	54	129	38	20	80	71	49	76	96	1:1	3,500	GER32	12.4

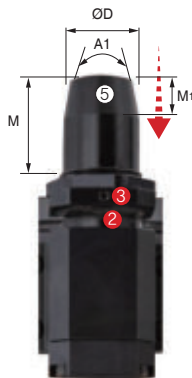


KAC (45° fixed)_Collet type

BT-KAC



Positioning pin



NO	Name
①	Head
②	Rotating angle graduation (Free radius position in 360°)
③	Positioning pin part
④	Jaw key
⑤	Height control wrench hole

NO	Part name	Designation
①	Head fixing bolts	BX0618
②	Set screw	BT0404
③	Fixing bolts	BXS0630

Shank size	M	M1	A1	ØD
BT40	Max: 32 Min: 26	10	20°	Ø19.6
BT50	Max: 35 Min: 29	15	20°	Ø28

Designation	ØD	L	L1	L2	L3	B	G	G1	P	Q	A	Max RPM	Collet	kg
BT50-KAC10-240	1.0~10.0	240	57	54	129	28	60	96	25	54	80	5,000	GER16	9.7
BT50-KAC13-240	1.0~13.0	240	57	54	129	28	60	96	25	54	80	5,000	GER20	10.7
BT50-KAC20-250	2.0~20.0	240	57	54	139	50	72	96	30	60	80	3,500	GER32	11.7



Zero fit collet

DZC

Correcting 10 - 20 μm runout generated at tool tip to 0-2 μm

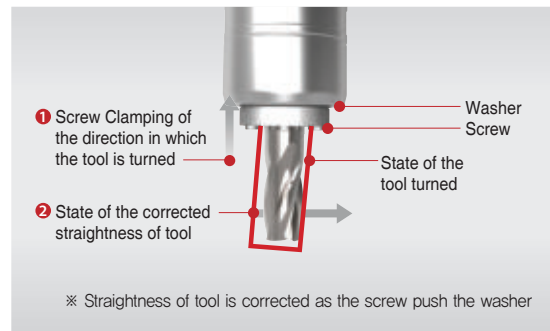
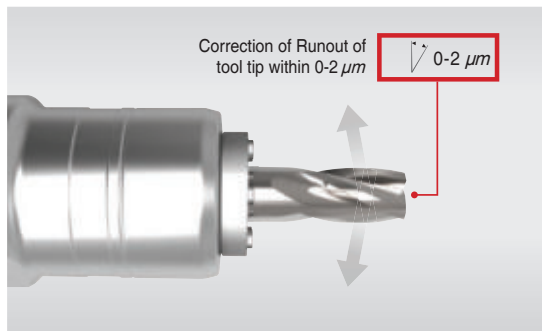
- Improves the runout and straightness of end tools
- Improves the surface roughness and quality of the machining area
- Improves the accuracy of boring hole dimension
- Improves the tool life of end tools



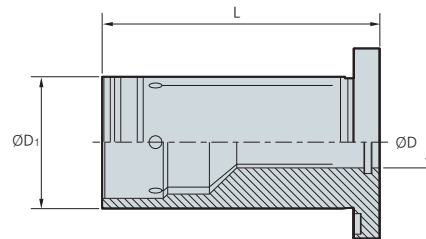
Code system



Features



DZC



(mm)

Designation	ØD	ØD ₁	L
DZC20-6	20	6	56.5
DZC20-8	20	8	56.5
DZC20-10	20	10	56.5
DZC20-12	20	12	56.5
DZC20-14	20	14	56.5
DZC20-16	20	16	56.5
DZC32-6	32	6	67.5
DZC32-8	32	8	67.5
DZC32-10	32	10	67.5
DZC32-12	32	12	67.5
DZC32-16	32	16	67.5
DZC32-20	32	20	67.5
DZC32-25	32	25	67.5

• Through coolant system not available



Jetcoolant collet (for milling chuck)

DCJ

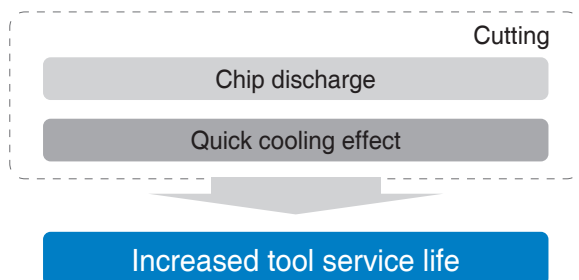
- Ensures a longer service life of cutting tools by preventing chips from adhering to tools
- Improves chip breakability/breaking strong jet injection
- Maintains the performance of the conventional milling chuck
- Enables a fast change of the inside jet coolant by collet replacement
- Available an ultrahigh-pressure inside coolant



Designation	Ø6	Ø8	Ø10	Ø12	Ø16	Ø20	Ø25	Ø32
NPM20	●	●	●	●	●			
NPM32	●	●	●	●	●	●	●	
NPM42	●	●	●	●	●	●	●	●

• Can be used for an ultrahigh–pressure inside coolant

➤ NPM + Jet coolant Collet



➤ Easy assembly



※ Can be used by only combining a collet with the conventional chuck (NPM)

➤ Coolant type

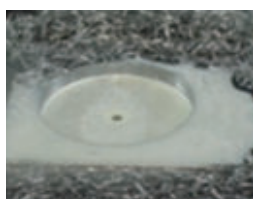
- Jet coolant



- Inside coolant



➤ Chip evacuation



➤ Coolant type

	Designation
DCJ20	DCJ20-6
	DCJ20-8
	DCJ20-10
	DCJ20-12
	DCJ20-16
DCJ32	DCJ32-6
	DCJ32-8
	DCJ32-10
	DCJ32-12
	DCJ32-16
	DCJ32-20
	DCJ32-25

Lock collet for milling chuck

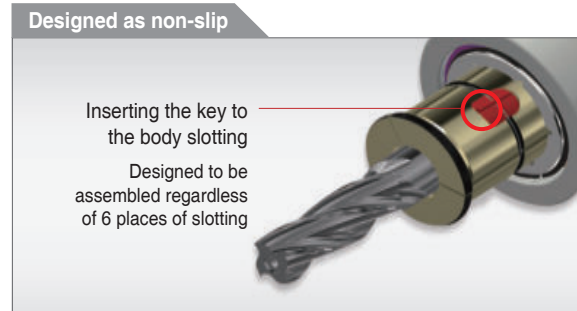
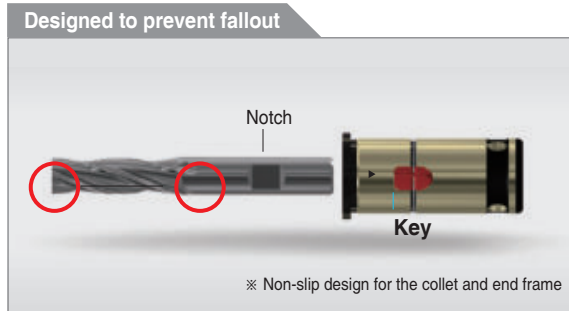
DCL

Milling chuck equipped with anti-fallout feature to prevent poor milling when machining a workpiece and improve tool service life (with DINE's milling chuck)

- Prevents the tool from falling out due to coolant pressure and vibration
- Useful for working with difficult-to-cut materials that require high workload
- Fit for difficult-to-cut materials with ultralight weight and high hardness in aerospace and automobile industries

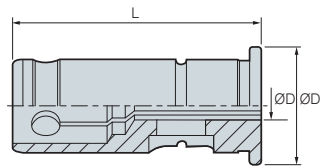


Features



- Designed especially for extreme machining with a lot of mechanical actions, prevents the tool from deviating or falling out
- Weldon flat (DINE 6535HB) end mill used
- Closely adhered to the grooves of the milling chuck - No slip occurring even under high torque

Detailed Specifications



(mm)

Designation	ØD	ØD ₁	L	Designation	ØD	ØD ₁	L
DCL20-6	6	20	53	DCL32-10	10	32	64.5
DCL20-8	8	20	53	DCL32-12	12	32	64.5
DCL20-10	10	20	53	DCL32-14	14	32	64.5
DCL20-12	12	20	53	DCL32-16	16	32	64.5
DCL20-14	14	20	53	DCL32-18	18	32	64.5
DCL20-16	16	20	53	DCL32-20	20	32	64.5
DCL32-6	6	32	64.5	DCL32-25	25	32	64.5
DCL32-8	8	32	64.5				

Parts

Basic			Basic		
Division	Key	C-Grip	Division	Key	C-Grip
Parts			Parts		
Designation			Designation		
DCL20-6	DCL20-6K	DCL-CG20	DCL32-10	DCL32-10K	DCL-CG32
DCL20-8	DCL20-8K	DCL-CG20	DCL32-12	DCL32-12K	DCL-CG32
DCL20-10	DCL20-10K	DCL-CG20	DCL32-14	DCL32-14K	DCL-CG32
DCL20-12	DCL20-12K	DCL-CG20	DCL32-16	DCL32-16K	DCL-CG32
DCL20-14	DCL20-14K	DCL-CG20	DCL32-18	DCL32-18K	DCL-CG32
DCL20-16	DCL20-16K	DCL-CG20	DCL32-20	DCL32-20K	DCL-CG32
DCL32-6	DCL32-6K	DCL-CG32	DCL32-25	DCL32-25K	DCL-CG32
DCL32-8	DCL32-8K	DCL-CG32			





KORLOY Anti-Vibration tool

KORLOY DAMPING PRO

- The application of a special design provides an excellent Anti-Vibration effect and is optimized for Overhang work
- Capable to elevate Feed comparing to standard arbor with stable machining
- Longer tool life and noise decrease
- Provides a solution for Mold, Deep Cavity machining, and Heavy-duty work

Code system

KDP - BT50 - FMA25.4 - 260

KORLOY DAMPING PRO

Arbor taper
BT type
HSK type
SK type

FMA: JIS B4113 Face milling
FMB: T-MAX Face milling/Shoulder Cutter
FMC: T-MAX Face milling/Shoulder Cutter

Length of gauge line

Features



- Anti-Vibration: Exclusively designed Anti-Vibration structure
- Material: Special alloy steel
- Anti-Vibration body: Application of high density damper
- Overhang: Capable for 2D~5D
- Coolant: Inner coolant is capable



BT type



HSK type

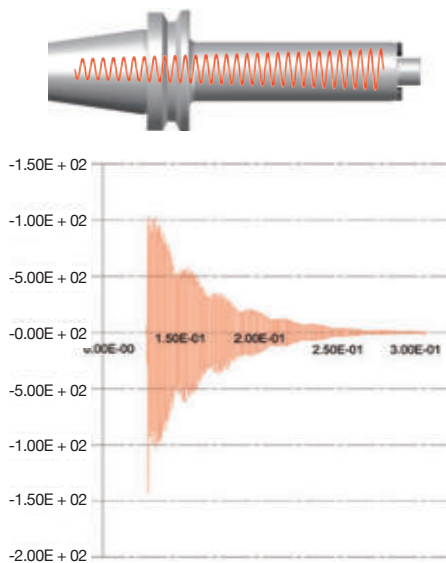


SK type

Various types and sizes are applicable

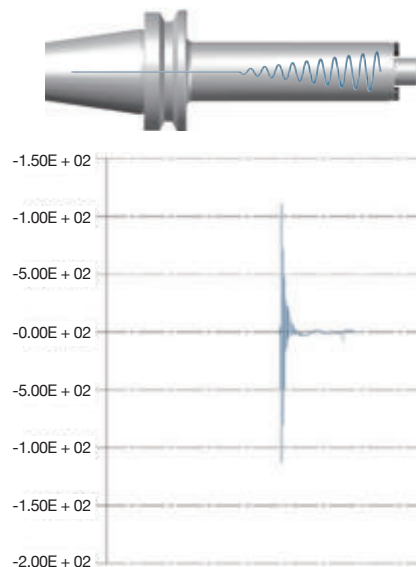
Comparison of vibration damping time

Standard Arbor



Longer Vibration damping time/
Chattering is caused while Overhang work

KORLOY DAMPIG PRO

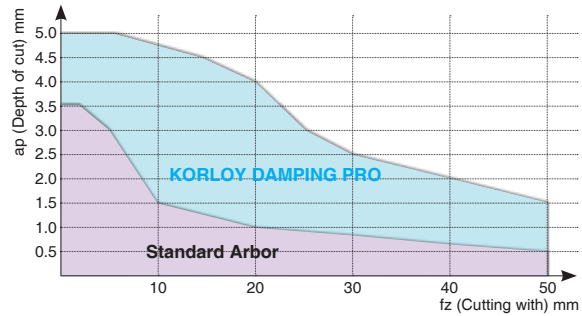


Short Vibration damping time/
Performance is 2~3 times better than standard arbor

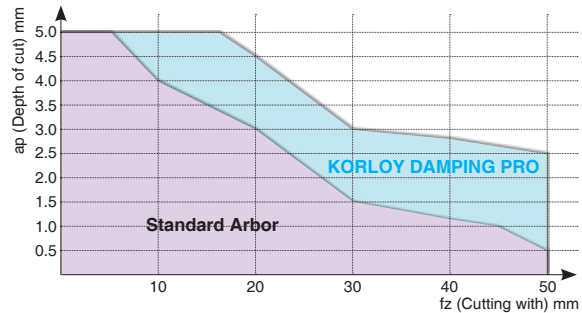


Performance evaluation

- **Cutting condition:** f_z (mm/t) = 0.1
 vc (m/min) = 100
- **Cutter:** AMC4063HS 6flute
- **Arbor:** BT50-FMC22-210 General arbor
KDP-BT50-FMC22-210 Damping pro



- **Cutting condition:** f_z (mm/t) = 0.1
 vc (m/min) = 100
- **Cutter:** FMRC3063HRD-H 6flute
- **Arbor:** BT50-FMC22-210 General arbor
KDP-BT50-FMC22-210 Damping pro

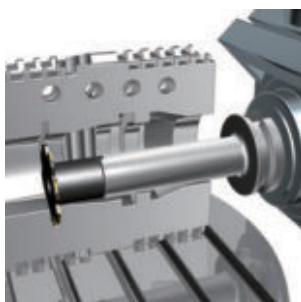


Application examples

Mold machining	Side milling cutter machining	Facing for long depth	Deep-hole Boring machining
Better productivity than general arbor	Excellent performance in the deep grooving	Better productivity and surface roughness than general arbor	Better surface roughness and machinability than general arbor

Side milling cutter machining example

- Faulty occurrence on size and surface roughness by the vibration, when use the general arbor
- Using **DAMPING PRO**, good size and surface roughness



- **General arbor**
Cutting condition:
 vc (m/min) = 50
 f_z (mm/t) = 0.1
 ae (mm) = 20
- **DAMPING PRO**
Cutting condition:
 vc (m/min) = 100
 f_z (mm/t) = 0.1
 ae (mm) = 20

Big size Crankshaft machining example

- General arbor: $ap = 2$ mm
- KORLOY DAMPING PRO: $ap = 4$ mm available
- **2 times better productivity**



- **General arbor**
Cutting condition:
 vc (m/min) = 100
 f_z (mm/t) = 0.15
 ap (mm) = 2
- **DAMPING PRO**
Cutting condition:
 vc (m/min) = 100
 f_z (mm/t) = 0.15
 ap (mm) = 4



BT-FMA

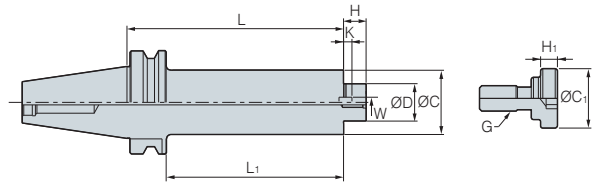


Fig. 1

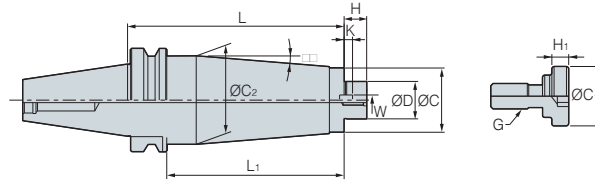








Fig. 2

(mm)

Designation	Cutter dia.	ØD	L	L ₁	ØC	ØC ₂	H	W	K	G	ØC ₁	H ₁	 kg	Fig.	α°	
KDP-BT40 -	FMA25.4-210	80	25.4	210	183	50	60	22	9.5	5	M12	33	10	5.42	2	1
	FMA25.4-260	80	25.4	260	233	50	60	22	9.5	5	M12	33	10	6.5	2	1.1
	FMA31.75-210	100	31.75	210	183	60	-	30	12.7	7	M16	40	10	5.94	1	-
	FMA31.75-260	100	31.75	260	233	60	-	30	12.7	7	M16	40	10	7.25	1	-
KDP-BT50 -	FMA25.4-210	80	25.4	210	172	50	78	22	9.5	5	M12	33	10	9.63	2	4
	FMA25.4-260	80	25.4	260	222	50	78	22	9.5	5	M12	33	10	11.8	2	3
	FMA31.75-210	100	31.75	210	172	60	85	30	12.7	7	M16	40	10	11.8	2	3
	FMA31.7-260	100	31.75	260	222	60	85	30	12.7	7	M16	40	10	13.6	2	2.5

- The A type is for JIS B4113 Face milling
- The B type and C type are arbors for T-MAX Face Milling and shoulder cutter
- The weight (kg) shown in the chart does not include the weight of face cutter
 - Key and screw are clamped
 - Wrench is separately sold

Parts

Division	Basic				For separate purchase
	Key	Clamp bolt	Wrench bolt	Wrench bolt	Wrench
Parts					
Designation					
FMA25.4	K9.5 (B)	MBA-M12	BX0412	BX1225	LW-10
FMA31.75	K12.7 (D)	MBA-M16	BX0515	-	LW-14



BT-FMC

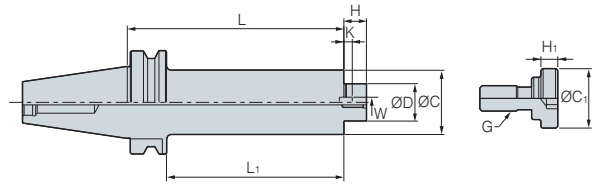


Fig. 1

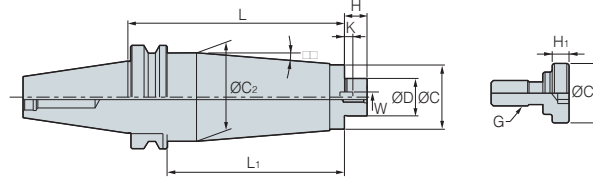


Fig. 2

(mm)

Designation	Cutter dia.	ØD	L	L ₁	ØC	ØC ₂	H	W	K	G	$\frac{G}{kg}$	Fig.	α°	
KDP-BT40 - FMC16-160	FMC16-160	40	16	160	133	38	-	17	8	5	M8	2.45	1	-
	FMC22-210	50/63	22	210	183	48	4.95	19	10	5.6	M10	4.37	2	0.1
	FMC22-260	50/63	22	260	233	48	60	19	10	5.6	M10	6.3	2	1.5
	FMC27-210	80	27	210	183	60	-	21	12	6.3	M12	6	1	-
	FMC27-260	80	27	260	233	60	-	21	12	6.3	M12	7.25	1	-
KDP-BT50 - FMC16-171	FMC16-171	40	16	171	133	38	-	17	8	5	M8	5.1	1	-
	FMC22-210	50/63	22	210	172	48	49.5	19	10	5.6	M10	7.3	2	0.1
	FMC22-260	50/63	22	260	222	48	62	19	10	5.6	M10	10	2	1
	FMC27-210	80	27	210	172	60	78	21	12	6.3	M12	10.6	2	2.5
	FMC27-260	80	27	260	222	60	78	21	12	6.3	M12	12.6	2	2
	FMC27-320	80	27	320	282	60	78	21	12	6.3	M12	14.8	2	1
	FMC32-210	100	32	210	172	78	-	24	14	7	M16	11.7	1	-
	FMC32-260	100	32	260	222	78	-	24	14	7	M16	14.2	1	-
FMC32-330	100	32	330	292	78	-	24	14	7	M16	16.6	1	-	

- The A type is for JIS B4113 Face milling
- The B type and C type are arbors for T-MAX Face Milling and shoulder cutter
- The weight (kg) shown in the chart does not include the weight of face cutter
 - Key and screw are clamped
 - Wrench is separately sold

Parts

Division	Basic				For separate purchase
	Key	Clamp bolt	Wrench bolt	Wrench bolt	Wrench
Parts					
Designation					
FMC16	K8.0 (A)	-	BX0310	BX0820	LW-6
FMC22	K10.0 (C)	-	BX0412	BX1030	LW-8
FMC27	K12.0	MBA-M12	BX0616	-	LW-10
FMC32	K14.0	MBA-M16	BX0820	-	LW-14



HSK-FMA

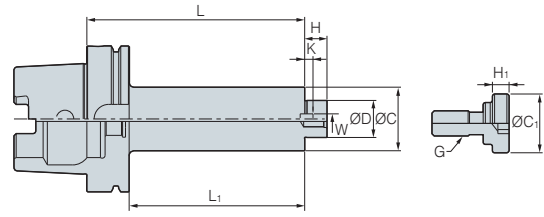


Fig. 1

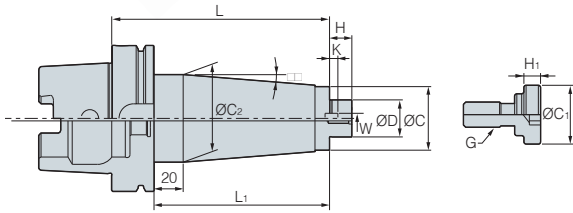


Fig. 2

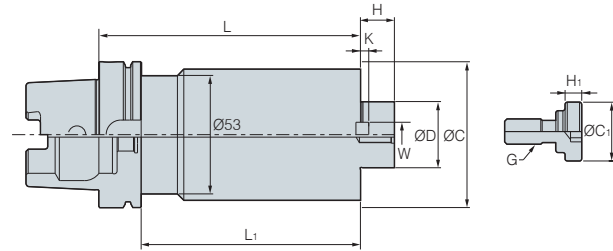


Fig. 3

(mm)

Designation	Cutter dia.	ØD	L	L ₁	ØC	ØC ₂	H	W	K	G	ØC ₁	H ₁	$\frac{G}{kg}$	Fig.	α°	
KDP-HSK63 -	FMA25.4-210	80	25.4	210	184	50	53	22	9.5	5	M12	33	10	4.55	3	0.1
	FMA25.4-260	80	25.4	260	234	50	53	22	9.5	5	M12	33	10	5.6	3	0.1
	FMA31.75-210	100	31.75	210	184	60	-	30	12.7	7	M16	40	10	5.52	2	-
	FMA31.75-260	100	31.75	260	234	60	-	30	12.7	7	M16	40	10	6.9	2	-
KDP-HSK100 -	FMA25.4-210	80	25.4	210	181	50	78	22	9.5	5	M12	33	10	8.32	3	4
	FMA25.4-260	80	25.4	260	231	50	78	22	9.5	5	M12	33	10	10.5	3	3
	FMA31.75-210	100	31.75	210	181	60	85	30	12.7	7	M16	40	10	10.9	3	3
	FMA31.75-260	100	31.75	260	231	60	85	30	12.7	7	M16	40	10	12.8	3	2.5

- The A type is for JIS B4113 Face milling
- The B type and C type are arbors for T-MAX Face Milling and shoulder cutter
- The weight (kg) shown in the chart does not include the weight of face cutter
 - Key and screw are clamped
 - Wrench is separately sold

Parts

Division	Basic				For separate purchase
	Key	Clamp bolt	Wrench bolt	Wrench bolt	Wrench
Parts					
Designation					
FMA25.4	K9.5 (B)	MBA-M12	BX0412	BX1230	LW-10
FMA31.75	K12.7 (D)	MBA-M16	BX0515	-	LW-14



HSK-FMC

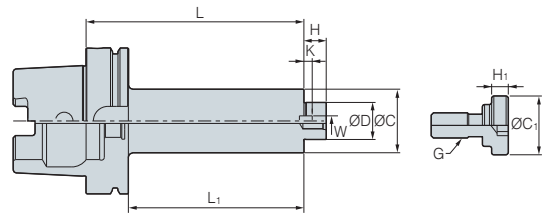


Fig. 1

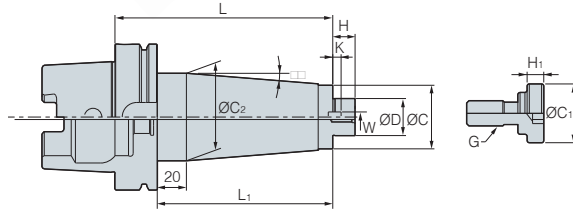


Fig. 2

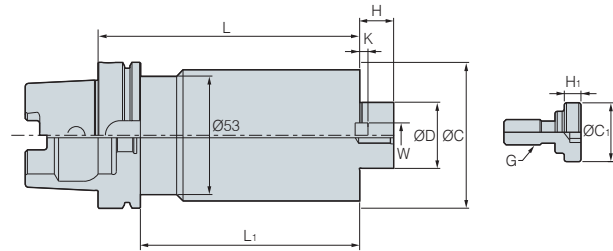


Fig. 3

(mm)

Designation	Cutter dia.	ØD	L	L ₁	ØC	ØC ₂	H	W	K	G	$\frac{G}{kg}$	Fig.	α°	
KDP-HSK63 -	FMC16-160	40	16	160	134	38	-	17	8	5	M8	2.10	1	-
	FMC22-210	50/63	22	210	184	48	4.95	19	10	5.6	M10	3.82	1	0.1
	FMC22-260	50/63	22	260	234	48	62	19	10	5.6	M10	6.14	3	1.6
	FMC27-210	80	27	210	184	60	-	21	12	6.3	M12	5.53	2	-
	FMC27-260	80	27	260	234	60	-	21	12	6.3	M12	6.83	2	-
KDP-HSK100 -	FMC16-160	40	16	160	131	38	-	17	8	5	M8	3.45	1	-
	FMC22-210	50/63	22	210	181	48	49.5	19	10	5.6	M10	4.60	3	0.1
	FMC22-260	50/63	22	260	231	48	62	19	10	5.6	M10	8.10	3	1
	FMC27-210	80	27	210	181	60	78	21	12	6.3	M12	8.44	3	2.5
	FMC27-260	80	27	260	231	60	78	21	12	6.3	M12	10.40	3	2
	FMC27-320	80	27	320	291	60	78	21	12	6.3	M12	13.60	3	1
	FMC32-210	100	32	210	181	78	-	24	14	7	M16	10.20	1	-
	FMC32-260	100	32	260	231	78	-	24	14	7	M16	13.00	1	-
	FMC32-330	100	32	330	301	78	-	24	14	7	M16	15.43	1	-

- The A type is for JIS B4113 Face milling
- The B type and C type are arbors for T-MAX Face Milling and shoulder cutter
- The weight (kg) shown in the chart does not include the weight of face cutter
 - Key and screw are clamped
 - Wrench is separately sold

Parts

Division	Basic				For separate purchase
	Key	Clamp bolt	Wrench bolt	Wrench bolt	Wrench
Parts					
Designation					
FMC16	K8.0 (A)	-	BX0310	BX0820	LW-6
FMC22	K10.0 (C)	-	BX0412	BX1030	LW-8
FMC27	K12.0	MBA-M12	BX0616	-	LW-10
FMC32	K14.0	MBA-M16	BX0820	-	LW-14



SK-FMC

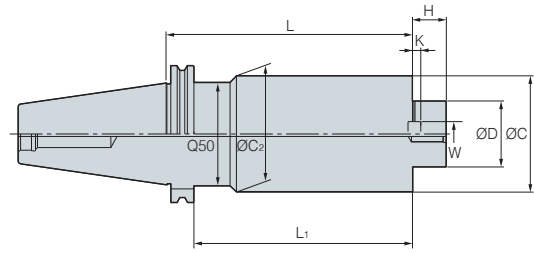


Fig. 1

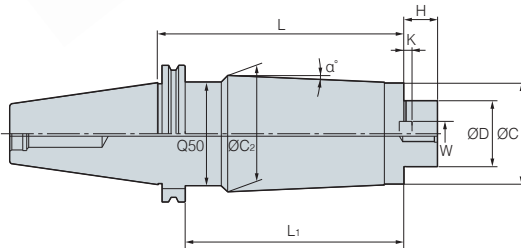


Fig. 2

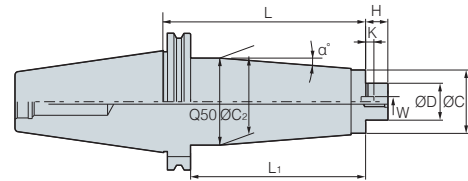


Fig. 3

(mm)

Designation	Cutter dia.	ØD	L	L ₁	ØC	ØC ₂	H	W	K	G	kg	Fig.	α°	
KDP-SK40 -	FMC22-210	50/63	22	210	183.0	48	49.5	19	10	4.4	M10	4.4	3	0.1
	FMC22-260	50/63	22	260	233.0	48	60	19	10	5.6	M10	6.2	2	1.4
	FMC27-210	80	27	210	183.0	60	60	21	12	6.3	M12	5.9	1	-
	FMC27-260	80	27	260	233.0	60	60	21	12	6.3	M12	7.2	1	-
KDP-SK50 -	FMC22-210	50/63	22	210	190.9	48	49.5	19	10	5.6	M10	6.4	3	0.1
	FMC22-260	50/63	22	260	240.9	48	62	19	10	5.6	M10	9.1	3	1
	FMC27-210	80	27	210	190.9	60	78	21	12	6.3	M12	9.8	3	2.5
	FMC27-260	80	27	260	240.9	60	78	21	12	6.3	M12	12.4	3	1.8
	FMC27-320	80	27	320	300.9	60	78	21	12	6.3	M12	14.5	3	1.2
	FMC32-210	100	32	210	190.9	78	-	24	14	7	M16	11.5	1	-
	FMC32-260	100	32	260	240.9	78	-	24	14	7	M16	14	1	-
	FMC32-330	100	32	330	310.9	78	-	24	14	7	M16	16.4	1	-

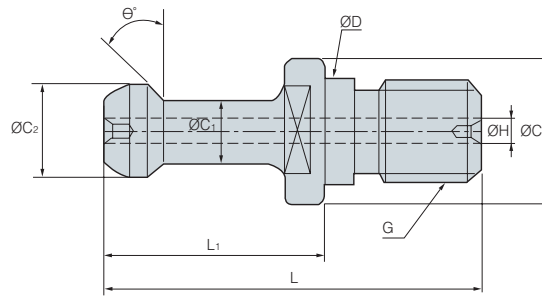
- The A type is for JIS B4113 Face milling
- The B type and C type are arbors for T-MAX Face Milling and shoulder cutter
- The weight (kg) shown in the chart does not include the weight of face cutter
 - Key and screw are clamped
 - Wrench is separately sold

Parts

Division	Basic				For separate purchase
	Key	Clamp bolt	Wrench bolt	Wrench bolt	Wrench
Parts					
Designation					
FMC16	K8.0 (A)	-	BX0310	BX0820	LW-6
FMC22	K10.0 (C)	-	BX0412	BX1030	LW-8
FMC27	K12.0	MBA-M12	BX0616	-	LW-10
FMC32	K14.0	MBA-M16	BX0820	-	LW-14



Pull Stud Bolt

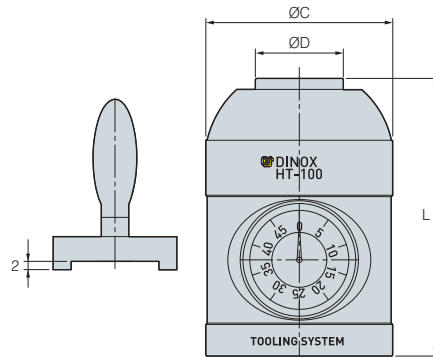


(mm)

Designation	ØD	ØC	ØC ₁	ØC ₂	L ₁	L	θ	G	ØH
P20T-1	8.5	12	6	8.5	17.5	31.5	15°	M8	
P30T-1	12.5	16.5	7	11	23	43	45°	M12	
P30T-1(Ø2.5)	12.5	16.5	7	11	23	43	45°	M12	Ø2.5
P30T-2	12.5	16.5	7	11	23	43	30°	M12	
P30T-2(Ø2.5)	12.5	16.5	7	11	23	43	30°	M12	Ø2.5
P40T-1	17	23	10	15	35	60	45°	M16	
P40T-1(3)	17	23	10	15	35	60	45°	M16	Ø3
P40T-2	17	23	10	15	35	60	30°	M16	
PS40-3F	17	23	10	15	35	60	0°	M16	
PS-G51	17	22	12.45	18.8	19.11	44.11	45°	M16	Ø7
DIN69872-A40	17	23	14	19	26	54	15°	M16	Ø7
DIN69872-B40	17	23	14	19	26	54	15°	M16	
JISB6339-A40(PS-806)	17	23	14	19	29	54	15°	M16	Ø7
JISB6339-B40(PS-805)	17	23	14	19	29	54	15°	M16	
P50T-1	25	38	17	23	45	85	45°	M24	
P50T-1(7)	25	38	17	23	45	85	45°	M24	Ø7
P50T-2	25	38	17	23	45	85	30°	M24	
PS50-1F	25	38	17	23	45	85	0°	M24	
PS50-1FH	25	38	17	23	45	85	0°	M24	Ø8
PS-G41	25	37	20.83	28.96	25.2	65.2	45°	M24	Ø10
DIN69872-A50	25	36	21	28	34	74	15°	M24	Ø11.5
P50T-1HS	25	38	17	23	45	85	45°	M24	Ø5.7



HT



(mm)

Designation	ØD	ØC	L
HT-100	32	68	100

- Good for setting the Tool length at CNC machine
- No inturference between height Touch setter and Tool makes safe work
- Location Accuracy: ± 0.003 mm



PARTS



H

Parts

H02	Shim
H03	Cartridge
H03	Chip Breaker
H03	Chip Cover
H03	Clamp
H04	Coolant Bolt
H04	Wrench Bolt
H04	Lever
H05	Locator
H05	Nut
H05	Pin
H05	Screw
H06	Shim Pin
H07	Spring
H07	Wrench
H07	Stop Ring
H07	Washer
H07	Stopper
H07	Nozzle

Geometry	Designation	Dimensions					
		a	b	c	d	angle	
	SC32	8.5	3.18		4.9		
	SC32N	8.5	3.18		4.88		
	SC42	12.5	3.18		6.9		
	SC42N	11.6	3.18		6.5		
	SC53	15.7	4.76		7.9		
	SC53N	14.6	4.76		8.11		
	SC63	18.85	4.76		10		
	SC63N	17.8	4.76		9.6		
	SC83	24.4	4.76		12.8		
	SC84N	24.2	6.35		13		
	SC42B	12.5	3.18		6.9		
		SC42CC	12.5	3.18		3.5	
		SC32D	9.27	3.18		6.48	
		SC43D	12.45	4.76		7.34	
		SC53D	15.62	4.76		9.65	
		SC63D	18.8	4.76		11.25	
		SC84D	25.08	6.35		14.85	
		SC42S	11.5	3.18		6.4	
		SC32S	8.3	3.18		5.4	
			SC63V	18.35	4.76		5.5
SC83V			25.3	4.76		6.55	
SC84V	25.3		6.35		6.35		
SC32V	9.12		3.18		3.4		
SC42V	12.6		3.18		4.5		
SC44V	12.6		6.35		4.5		
SC54V	15.75		6.35		5.5		
SS32V	9.12		3.18		3.4		
SS42V	12.6		3.18		4.5		
SS54V	15.75		6.35		5.5		
SS64V	18.9	6.35		5.5			
	SD317	9.35	2.7		5.2		
	SD32N	8.5	3.18		4.88		
	SD42	12.5	3.18		6.9		
	SD42N	11.6	3.18		6.5		
	SD43N	11.6	4.75		6.5		
	SD32D	9.2	3.18		5.8		
	SD43D	12.45	4.76		7.34		
	SD32S	8.5	3.18		5.4		
	SD42S	11.5	3.18		6.4		
	SD32V	9.12	3.18		3.4		
	SD43V	12.6	4.76		4.5		
	SD44V	12.6	6.35		4.5		

Geometry	Designation	Dimensions				
		a	b	c	d	angle
	SES33C	9.1	12	4.76	3.5	
		SK33C	9.33	14.7	4.8	3.5
SK33CL		9.33	14.7	4.8	3.5	
	SR10	8.4	3.18		4.7	
	SR12	10	3.18		4.7	
	SR16	13.55	4.76		6.9	
	SR20	17.1	4.85		7.9	
	SR25	22	6.35		9.6	
	SR32	27.8	6.35		13	
	SR42CC	12.575	3.18		3.5	
	SR10S	8.8	3.18		5.4	
	SR12S	10.55	3.18		5.4	
	SS32	8.5	3.18		4.9	
	SS32N	8.5	3.18		4.88	
	SS42	12.5	3.18		6.9	
	SS42B	12.5	3.18		6.9	
	SS42N	11.6	3.18		6.5	
	SS53	15.7	4.76		7.9	
	SS53N	14.6	4.76		8.11	
	SS63	18.85	4.76		10	
	SS63N	17.8	4.76		9.6	
	SS84	24.4	6.35		12.8	
SS84N	24.2	6.35		13		
	SS42CC	12.5	3.18		3.5	
	SS32CC	9.3	3.18		3.5	
	SS32D	9.27	3.18		5.77	
	SS43D	12.45	4.76		7.34	
	SS53D	15.62	4.76		9.65	
	SS63D	18.8	4.76		11.25	
	SS84D	25.15	6.35		14.43	
	SS32S	8.3	3.18		5.4	
	SS42S	11.5	3.18		6.4	
	SS42SAF	11.2	3		5.5	
		ST317	9.35	2.7		5
ST317B		9.35	2.7		5	
ST317N		8.5	2.7		4.88	
ST42		12.5	3.18		6.9	
ST42N		11.6	3.18		6.5	
ST53	15.7	4.76		7.9		



Shim

Geometry	Designation	Dimensions				
		a	b	c	d	angle
	ST32CC	9.35	3.18		3.5	
	ST32C1	9.13	3.18		4.95	
	ST42C1	12.3	3.18		4.95	
	ST32D	9.35	3.18		5.77	
	ST43D	12.52	4.76		7.34	
	ST53D	15.7	4.76		9.65	
	ST63D	18.87	4.76		11.25	
	ST32M	8.7	3.18		4.7	
	ST43M	12.5	4.76		6.3	
	ST32S	8.5	3.18		5.4	
	ST32V	9.12	3.18		3.4	
	ST44V	12.6	6.35		4.5	
	SV32D	9.2	3.18		5.8	
	SV43D	12.29	4.76		7.34	
	SV32D2	9.2	3.18		5.8	
	SV32S	8.4	3.18		5.4	
	SW317	9.35	2.7		5	
	SW317N	8.5	2.7		4.88	
	SW42	12.5	3.18		6.9	
	SW42N	11.6	3.18		6.5	
	SW32D	9.25	3.18		5.8	
	SW43D	12.45	4.76		7.34	
	SW53D	15.62	4.76		9.65	
	SW63D	18.8	4.76		11.25	
	SW84D	24.89	6.35		14.43	
	SW43M	12.5	4.76		6.2	
	SW32M	8.52	3.18		5.2	
	SW32V	9.12	3.18		3.4	
	SW44V	12.6	6.35		4.5	
	SW54V	15.75	4.76		5.5	

Cartridge

Geometry	Designation	Dimensions				
		a	b	c	d	angle
	LAPDR-AJ	M4x0.7	30	15	10	

Chip breaker

Geometry	Designation	Dimensions				
		a	b	c	d	angle
	CB20	8.5	3.4	20		

Chip cover

Geometry	Designation	Dimensions				
		a	b	c	d	angle
	CFMP3R14R1-A	10.5	20	1	(Ø4.3)	
	CFMP3R-A	8	18	1	(Ø4.3)	
	CFMP4R-A	8	22	1	(Ø4.3)	

Clamp

Geometry	Designation	Dimensions				
		a	b	c	d	angle
	CA05R	8.9	5.5	17.6	3.3	
	CA06R	12	7.2	20.6	5.3	
	CH5R3	7.85	7.2	14.8	3.1	
	CH6R4	12.02	9	23.97	3.75	
	CBH4.5R1	8	5.74	17.7	4	
	CBH4.5R2	9.5	6.4	18	4	
	CBH5R1	10	7.8	21.3	5	
	CBH6R1	12	9.3	26	6	
	CDH6N	9.5	10	18.6	6.1	
	CDH7N	7.9	11.4	14.7	4.7	
	CDH8N	10.9	16.9	22.4	6.1	
	CDH8N1	10.9	16.9	19.1	6.1	
	CDH8N2	10.9	16.9	25.4	6.1	
	CDH8N3	12.5	19.8	25.4	9.2	
	CDS8N	10.8	17	22.2	5	
	CGH5R1	19.5	9.5	28.8	2.5	
	CGH5R2	20.5	9.5	28.8	3.5	
	CGH5R3	22.5	9.5	28.8	5.5	



Clamp

Geometry	Designation	Dimensions				
		a	b	c	d	angle
	CGH6R1	22.3	11.9	23.2	2.5	
	CGH6R2	23.2	11.9	23.2	3.4	
	CGH6R3	24.0	11.9	23.2	4.2	
	CHH3.5R1	7.5	6.7	13	2.45	
	CHH4.5R1	7.9	7.85	14.1	2.54	
	CHH5.5R1	9.8	10	16.4	4	
	CH4R1	7.4	5	14.1	3.1	
	CH5R1	10.0	6.6	20.2	4.5	
	CH5R2	6.85	7	13.8	2	
	CH6R2	8.85	8.7	16.5	2	
	CH6R3	11.8	10	23	4.2	
	CMH5R1	18.5	7.9	16	6.26	
	CMH6R2	20.0	11	17.5	13.8	
	CMH6R6	18.5	7.9	16	6.26	
	CMH6R1	24	8.5	16.5	8.28	
	CMH6R3	20.0	11	17.51		
	CMH6L3	20.0	11	17.51		
	CS5R1	6.8	7	14.5	2	
	CS6R1	8.8	8.5	18.1	2.7	
	CS8R1	11.8	10	23	4.2	
	CTH6L1	23.5	12	25.4	14.35	
	CTH6R1	23.5	12	25.4	14.35	
	CTH6R2	21.78	12.9	31.22	17.33	
	CVH3	21	11	5.8	7.7	
	CVH3V	29	14	7	8	
	CVH4	25.5	14.5	6	7	
	CVH5	30	17	7.5	9.5	
	CVH6	33.5	18.5	8	10	
	CXH8N	10.1	10.0	17.5	-	

Coolant bolt

Geometry	Designation	Dimensions					
		a	b	c	d	B(T)	a'
	CBA063-3IN/MM	M10	Ø25	Ø16	37	8	(27)
	CBA063-4IN/MM	M10	Ø25	Ø16	42.5	8	(27)
	CBA080-IN/MM	M12	Ø28	Ø18	45.5	10	(32)
	CBP063-IN/MM	M10	Ø22	Ø16	38.6	8	(27)
	CBP080-IN/MM	M12	Ø25	Ø18	48.6	10	(32)

Coolant bolt

Geometry	Designation	Dimensions						
		a	b	c	d	B(T)	a'	
	CBA100-IN/MM	M16	Ø54	Ø43	47	14	(32)	
	CBA100-IN-25.4	M12	Ø44	Ø36	41.5	10	(25)	
	CBA125-IN	M20	Ø65	Ø54	56	17	(38)	
	CBA125-IN-25.4	M12	Ø44	Ø36	43.5	10	(25)	
	CBA125-MM	M20	Ø65	Ø54	57	17	(35)	
	CBA160-IN	M24	Ø83	Ø73	56	19	(38)	
	CBA160-MM	M20	Ø83	Ø73	53	17	(34)	
	CBP100-IN	M16	Ø50	Ø43	48.6	14	(32)	
	CBP100-IN-25.4	M12	Ø44	Ø36	46.5	10	(25)	
	CBP100-MM-1	M16	Ø50	Ø43	48.6	14	(36)	
	CBP125-IN	M20	Ø65	Ø54	56	17	(35)	
	CBP125-IN-25.4	M12	Ø44	Ø36	55	10	(28)	
	CBP125-MM	M20	Ø65	Ø54	57	17	(35)	
	CBP125-MM-1	M20	Ø61	Ø54	65.6	14	(33)	
	CBP160-IN	M24	Ø83	Ø73	56	19	(38)	
	CBP160-MM	M20	Ø83	Ø73	53	17	(34)	

Wrench bolt

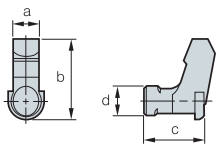
Geometry	Designation	Dimensions				
		A	C	K	L	M
	SB0825	13	6	8	25	M08 x 1.25
	SB1025	16	8	10	25	M10 x 1.50
	SB1035	16	8	10	35	M10 x 1.50
	SB1230	18	10	12	30	M12 x 1.75
	SB1630	24	14	16	30	M16 x 2.0
	SB1645	24	14	16	45	M6 x 2.0
	SB2040	30	17	20	40	M20 x 2.5
	CB1025	13	6	8	25	M08x1,25
	CB1025	16	8	10	25	M10x1,50
	CB1035	16	8	10	35	M10x1,50
	CB1230	18	10	12	30	M12x1,75
	CB1245	18	10	12	45	M12x1,75
	CB1630	24	14	16	30	M16x2,0
	CB1645	24	14	16	45	M16x2,0
	CB2040	30	17	20	40	M20x2,5

Lever

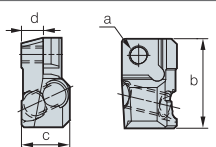
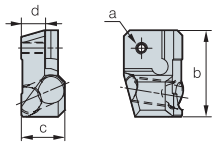
Geometry	Designation	Dimensions				
		a	b	c	d	
	LR10	3.4	10.8	11.7	3	
	LR12	3.7	13.5	13.4	3.5	
	LR16	4.75	18.7	18.3	4.3	
	LR20	5.9	20.5	18.7	5.55	
	LR25	7.35	24.25	23.7	6.2	
	LR32	8.45	29.7	26.95	7.9	
		LV2	2.6	7.75	6	2.1
		LV3B	3.1	10	9.5	3.7
		LV4B	4.7	14.55	15.6	4.7
		LV4BN	4.7	16	14.9	4.68
LV3		3.7	10	12	3.6	
LV3N		3.75	10	12	3.55	
LV3AN		3.75	12.1	11.4	4.64	
LV3C		3.1	10	7.85	3.6	
	LV3CN	3.2	10	7.8	3.6	
	LV3DN	3.2	11.65	9.5	3.55	
	LV4	4.7	14.55	14	4.7	
	LV4N	4.7	13.45	13.2	4.68	
	LV5	6	17.1	17	6	
	LV5N	6	16.4	17.08	5.95	
	LV5AN	6	18.82	17.3	5.95	
	LV6N	7.5	20.5	21	7.6	
	LV8N	8.6	25.5	25.4	8.6	



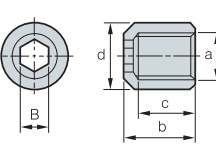
Lever

Geometry	Designation	Dimensions			
		a	b	c	d
	LV4A	4.6	13.24	9.95	4.7
	LV4AN	4.7	13.3	10	4.68

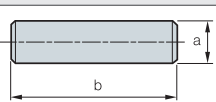
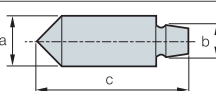
Locator

Geometry	Designation	Dimensions			
		a	b	c	d
	LFMP3R-A	M3.5	18.7	10.1	4.6
	LFMP4R1-A	M4.5	24.3	13.8	6.2
	LFMP4R-A	M4.5	26.3	13.8	6.2
	LFMA3R-A	M3	18.5	9.5	4.8
	LFMA4R-A	M3.5	26	13.1	7.3

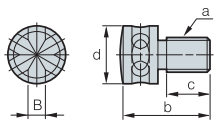
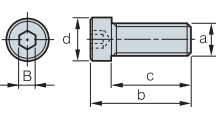
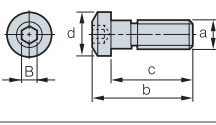
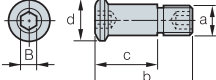
Nut

Geometry	Designation	Dimensions					
		a	b	c	d	B(T)	á
	N0407	M4 X 0.7	7.5	6	7	3	
	N0508	M5 X 0.8	8.3	6.6	7	3	

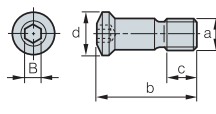
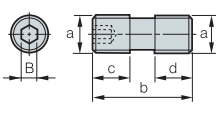
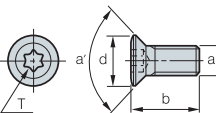
Pin

Geometry	Designation	Dimensions		
		a	b	c
	PN0308	3.0	8	
	PN0310	3.0	10	
	PN0312	3.0	12	
	PN0314	3.0	14	
	PN0515	4.8	3.3	14.5

Screw

Geometry	Designation	Dimensions					
		a	b	c	d	B(T)	á
	AZ0508F	M5 X 0.5	13	8	9	Ø2	
	AZ0514	M5 X 0.8	14	7	9	Ø2.5	
	BHA0510	M5 X 0.8	15	10	8.5	4.0	
	BHA0512	M5 X 0.8	17	12	8.5	4.0	
	BHA0612	M6 X 1.0	18	12	10	5.0	
	BHA0614	M6 X 1.0	20	14	10	5.0	
	BHA0616	M6 X 1.0	22	16	10	5	
	BHA0619-NYLOK	M6 X 1.0	25	19	10	5	
	CHX0407	M4 X 0.7	9.5	7.36	5.7	2.5	
	CHX0415	M4 X 0.7	17.5	15	5.4	2.5	
	CHX0510	M5 X 0.8	13.1	10.1	7.7	3	
	CHX0518	M5 X 0.8	21.5	18	8	3	
	CHX0622	M6 X 1.0	26.5	22	10	4	
	CHX0513	M5 X 0.8	13	8	6.4	2.5	
	CHX0616	M6 X 1.0	16.2	10.1	8.5	3	
	CHX0617L	M6 x 1.0 (ø4.4)	17.2	10.1	8.5	3	
	CHX0621	M6 X 1.0	21	10.1	8.5	3	

Screw

Geometry	Designation	Dimensions					
		a	b	c	d	B(T)	á
	CHX0625	1/4-20UNC	24.8	11	10	4	
	CTX03510	M3.5 X 0.6	10	4.7	5.3	15	
	CTX04513	M4.5 X 0.75	13.1	6.9	6.8	20	
	CTX04513H	M4.5 X 0.75	13.1	7.2	6.8	20	
	CTX0515	M5 X 0.8	15	8	7	20	
	CTX0517	M5 X 0.8	17.5	10	7	20	
	CTX0621	M6 X 1.0	21.2	12.4	9	25	
	DHA0514	M5 X 0.8	14.0	5.0	7.0	2.5	
	DHA0617	M6 x 1.0	17.0	7.0	7.5	3.0	
	DHA0620	M6 x 1.0	20.0	8.0	8.0	3.0	
	DHA0624	M6 x 1.0	24.0	12.0	8.5	3.0	
	DHA0815	M8 X 1.25	15.5	6.25	6.25	4.0	
	DHA0818F	M8 X 1.0	18	8.5	5.5	4.0	
	DHA0820	M8 X 1.25	20.0	8.0	9.0	4.0	
	DHA0821F	M8 X 1.0	21.0	8.5	8.5	4.0	
	DHA0825	M8 X 1.25	25.0	10.0	9.0	4.0	
	DHA0830	M8 X 1.25	30.0	11.5	11.5	4.0	
	ETGA0520CBM	M5 X 0.8	20	6.5	20	43°	
	ETGD0825	M8 X 1.25	25.2	11.1	40	40°	
	ETKA0523	M5 X 0.8	23	7.6	20	43°	
	ETKA0625	M6 X 1.0	25.5	8.8	20	43°	
	ETKD0516	M5 X 0.8	16.4	8.8	20	40°	
	ETKD0620	M6 X 1.0	20	6.3	25	40°	
	ETNA02506	M2.5 X 0.45	5.7	3.4	7	43°	
	ETNA0408	M4 X 0.7	8.0	5.1	15	43°	
	ETNA0412	M4 X 0.7	12	5.1	15	43°	
	ETNA0511	M5 X 0.8	11.0	6.4	20	43°	
	ETND02506F	M2.5 X 0.35	6.25	3.1	7	40°	
	ETND0307F	M3 X 0.35	7.8	3.7	8	40°	
	ETND03509	M3.5 X 0.6	9.6	4.7	10	40°	
	FTGA03507	M3.5 X 0.6	7.0	5.3	15	60°	
	FTGA03508	M3.5 X 0.6	8.0	5.3	15	60°	
	FTGA03510	M3.5 X 0.6	10.0	5.3	15	60°	
	FTGA03512	M3.5 X 0.6	12.0	5.0	15	60°	
	FTGA0411F	M4 X 0.5	11.0	7.0	15	60°	
	FTGA0417CBM	M4 X 0.7	17.0	5.5	15	62°	
	FTGA0510-P	M5 X 0.8	10.0	7.0	20	63°	
	FTGA0512-P	M5 X 0.8	12.0	7.0	20	63°	
	FTGA0513	M5 X 0.8	13.2	7.0	20	61°	
	FTGA0513-P	M5 X 0.8	13.0	7.0	20	63°	
	FTGA0517	M5 X 0.8	17.0	7.5	20	61°	
	FTGA0621	M6 X 1.0	21.5	9.0	20	61°	
	FTGA0826	M8 X 1.25	26.0	11.6	25	61°	
	FTKA02206	M2.2 X 0.45	5.5	3.0	6	60°	
	FTKA02206S	M2.2 X 0.45	5.6	3.05	7	60°	
	FTKA02555	M2.5 X 0.45	5.5	3.5	7	60°	
	FTKA02565	M2.5 X 0.45	6.5	3.5	7	60°	
	FTKA02565S	M2.5 X 0.45	6.5	3.8	8	60°	
	FTKA0307	M3 X 0.5	7.2	4.2	9	60°	
	FTKA03508	M3.5 X 0.6	8.4	5.5	15	60°	
FTKA03510	M3.5 X 0.6	10.4	5.5	15	60°		
FTKA03511A	M3.5 X 0.6	11.0	5.2	15	60°		
FTKA0408	M4 X 0.7	8.4	5.5	15	60°		
FTKA0410	M4 X 0.7	10.0	5.5	15	60°		
FTKA0411K	M4 X 0.7	11.0	6.8	15	60°		
FTKA0412B	M4 X 0.7	12.5	5.5	15	60°		
FTKA0413	M4 X 0.7	13.0	5.5	15	60°		
FTNA01633	M1.6 X 0.35	3.3	2.6	6	60°		
FTNA0203	M2 X 0.4	3.0	2.7	6	60°		
FTNA02033	M2 X 0.4	3.3	2.7	6	60°		
FTNA0204	M2 X 0.4	4.3	2.7	6	60°		
FTNA02205	M2.2 X 0.45	4.5	3.0	6	60°		
FTNA0238	M2 X 0.4	3.8	3.0	6	60°		
FTNA0305	M3 X 0.5	5.2	4.2	9	60°		
FTNA0306	M3 X 0.5	6.2	4.2	9	60°		
FTNA0307	M3 X 0.5	7.2	4.2	9	60°		
FTNA0408	M4 X 0.7	8.5	5.5	15	60°		
FTNA0411	M4 X 0.7	11.0	5.5	15	60°		
FTNA0511	M5 X 0.8	11	7.0	20	63°		
FTNA0513	M5 X 0.8	13.0	7.0	20	60°		
FTNA0516	M5 X 0.8	16.0	7.0	20	60°		



Screw

Geometry	Designation	Dimensions					
		a	b	c	d	B(T)	á
	FTNB0411	M4 X 0.7	10.8	5.7	15	60°	
	FTNC04509	M4.5 X 0.75	9.5	6.8	20	55°	
	FTNC04511	M4.5 X 0.75	11.5	6.8	20	55°	
	FTNB0209	2 X 0.4	9	2.5	2.7	60°	
	FTNB0209-P	2 X 0.4	9	2.5	2.7	60°	
	FTNB02512	2.5 X 0.45	12	3.5	3.5	60°	
	FTNB02512-P	2.5 X 0.45	12	3.5	3.5	60°	
	FTNB02514	2.5 X 0.45	14	3.5	3.5	60°	
	FTNB02514-P	2.5 X 0.45	14	3.5	3.5	60°	
	FTNB0316	3 X 0.5	16	4.5	4.2	60°	
	FTNB0316-P	3 X 0.5	16	4.5	4.2	60°	
	FTNB0319	3 X 0.5	19	5	4.5	60°	
	FTNB03522	3.5 X 0.6	22	5.6	5.5	60°	
	FTNB03524	3.5 X 0.6	24	5.6	5.5	60°	
	FTNB0426	4 X 0.7	26	6.7	5.5	60°	
	FTNB0528	5 X 0.8	28	6.5	7	60°	
	KHA0508	M5 X 0.8	8		2.5		
	KHA0510	M5 X 0.8	10		2.5		
	KHA0610	M6 X 1.0	10		3		
	KHA0612	M6 X 1.0	12		3.0		
	KHA0812	M8 X 1.25	12		4.0		
	KHA0815	M8 X 1.25	15		4.0		
	KHA1015	M10 X 1.5	15		5.0		
	KHA1020	M10 X 1.5	20		5.0		
	KHB0417	M4 X 0.7	17.2	4.5	2.5	2	
	KHB0406	M4 X 0.7	6	4.2	3	2	
	KHC0510	M5 X 0.8	10	8.1	2.5	90°	
	KHC0610	M6 X 1.0	10	7.8	3.0	90°	
	KHC0812	M8 X 1.25	12	9	4.0	90°	
	KHC1016	M10 X 1.5	16	12.3	5.0	90°	
	KHC1020	M10 X 1.5	20	16.3	5.0	90°	
	KHD0510	M5 X 0.8	10	9	3	2.5	
	KHD0610	M6 X 1.0	10	10	4	3	
	KHD0810	M8 X 1.25	10	10	7.5	4	
	LTX0512	M5 X 0.8	15.1	12	7.3	20	
	LTX0514	M5 X 0.8	17.1	14	7.3	20	
	MHA0512	M5 X 0.8	17.0	10.8	8.0	4.0	
	MHB0310	M3 X 0.5	13.4	8.0	5.5	2.5	
	MHB0410	M4 X 0.7	14.0	8.0	7.0	3.0	
	MHB1055	M10 X 1.5	65	50	16	8	
	MHB1260	M12 X 1.75	72	55	18	10	
	MHB1680	M16 X 2.0	96	75	24	14	
	MHX0523	M5 X 0.8	23.5	9.7	10	2.5	
	MHX0626	M6 X 1.0	25.8	10	11	3	
	MHX0630	M6 X 1.0	30	12.5	10.5	4	
	PTKA02508	M2.5 X 0.45	8	5	3.8	8	92°
	PTKA03510	M3.5 X 0.6	10	5	5	15	92°
	PTKA0407	M4 X 0.7	7	4.6	5.5	15	86°
	PTKA0407F	M4 X 0.5	7.3	3.8	6.5	15	91°
	PTKA0408	M4 X 0.7	8	5.6	5.5	15	86°
	PTKA0408F	M4 X 0.5	8.3	5.7	6.5	15	91°
	PTKA0409F	M4 X 0.5	9.3	6.7	6.5	15	91°
	PTKA0410F	M4 X 0.5	10.3	7.7	6.5	15	91°
	PTKA0411F	M4 X 0.5	11.3	8.7	6.5	15	91°
	PTKA0412	M4 X 0.7	12	7.5	5.9	15	92°
	PTKA0412F	M4 X 0.5	12.3	9.7	6.5	15	91°
	PTKA0413F	M4 X 0.5	13.3	10.7	6.5	15	91°
	PTKA0512	M5 X 0.8	12	7	6.9	20	92°
	PTMA03508	M3.5 X 0.6	8	5.3	6	9	90°
	PTMA0403F	M4 X 0.5	3.3	1.7	6.5	15	91°
	PTMA0404F	M4 X 0.5	4.3	2.7	6.5	15	91°
	PTMA0405F	M4 X 0.5	5.3	3.7	6.5	15	91°
PTMA0406F	M4 X 0.5	6.3	4.7	6.5	15	91°	
PTMA0411	M4 X 0.7	11	8.5	6.6	15	90°	

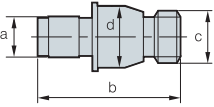
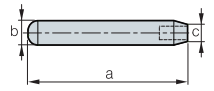
Geometry	Designation	Dimensions					
		a	b	c	d	B(T)	á
	FHGA0618	M4 X 0.7	11	6.9	6	15	
	FHGA0618	M6 X 1.0	18		8.5	4.0	61°
	PXMA0306	M3 X 0.5	5.9		5.7	2	90°
	SHX0310	M3 X 0.5	10		5.9	2	91°
	RHA0510	M5 X 0.8			10		4.0
	RHA0613	M6 X 1.0	16.3	13	10.5		4.0
	RHA0620	M6 X 1.0	24	20	10.5		4.0
	VHX0509B	M5 X 0.8	9	4.15	5	2	
	VHX0512B	M5 X 0.8	12	6.5	5	2	
	VHX0512BN	M5 X 0.8	12	6.56	5	2	
	VHX0514	M5 X 0.8	14.5	8.25	5	2	
	VHX0613N	M6 X 1.0	13.4	7.5	5.93	2.5	
	VHX0617	M6 X 1.0	17	10	6	2.5	
	VHX0617N	M6 X 1.0	16.75	8.34	5.9	2.5	
	VHX0621	M6 X 1.0	21	14	6		
	VHX0817N	M8 X 1.0	17.05	7.98	7.9	3	
	VHX0820N	M8 X 1.0	20.7	7.98	7.9	3	
	VHX0820AN	M8 X 1.0	20.5	10.36	7.9	3	
	VHX0821	M8 X 1.0	21	10	8	3	
	VHX0821N	M8 X 1.0	21.2	9.68	7.9	3	
	VHX0823N	M8 X 1.0	23.5	10.36	7.9	3	
	VHX0825	M8 X 1.0	25	12	8	3	
	VHX1027N	M10 X 1.0	27.2	14.4	9.8	5	
VHX1236N	M12 X 1.0	36	18.3	11.8	5		
	VHX0613A	M6 X 1.0	13.4	9.1	6.0	2.5	
	SHXN0509F	M5 X 0.5	M3.5 X 0.6	8.65	6.3	3.5	
	SHXN0609F	M6 X 0.75	M4 X 0.7	9	7.8	4	
	SHXN0610F	M6 X 0.75	M4 X 0.5	10	7.8	4	
	SHXN0712F	M7 X 0.75	M5 X 0.8	12	8.5	5	
	WTX0813	M8 X 1.25	17.2	4.9	8.5	25	
	WTX0817	M8 X 1.25	22	4.9	8.5	25	

Shim pin

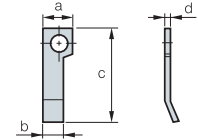
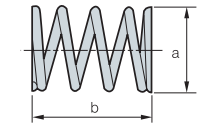
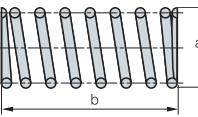
Geometry	Designation	Dimensions			
		a	b	c	d
	SP3	5.5	3.5	5.9	
	SP3N	6.85	3.3	5.55	
	SP4	7.0	4.0	7.6	
	SP4N	5.8	4.35	7.4	
	SP5	8.5	4.5	8.8	
	SP5N	8.5	5.68	9	
	SP6N	11.1	6.0	11.0	
	SP8N	12.0	10.0	15.35	
	SP2M	5	14	M5 X 0.8	6
	SP3M	3.5	19.5	M4 X 0.7	4
	SP3M-1	3.5	16.5	M4 X 0.7	4
	SP4M	5	19	M5 X 0.8	6



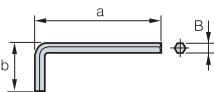
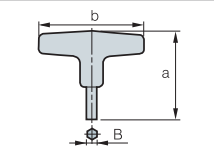
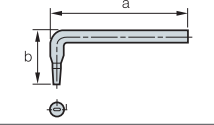
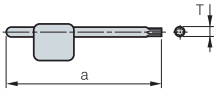
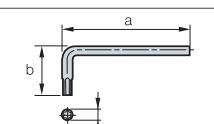
Shim pin

Geometry	Designation	Dimensions			
		a	b	c	d
	SP3D	3.7	13.1	UNF10-32	5.6
	SP3D2	3.6	12	UNF10-32	5.5
	SP3DS	3.7	11.54	UNF10-32	5.6
	SP4D	4.97	17.19	UNF1/4 28	7.12
	SP4DL	5	17.1	UNF1/4 28	7
	SP4DS	4.97	13.26	UNF1/4 28	
	SP5D	6.21	21.9	UNF5/16-24	9.44
	SP6D	7.75	21.9	UNF3/8-24	11.02
SP8D	9.02	29.63	UNF7/16-20	14.21	
	LSPS3	60	8.2	5.55	
	LSPS4	65	10	7	
	LSPS5	69	11.4	8.85	
	LSPS6	69	13	11	
	LSPS8	73	16.5	15.2	

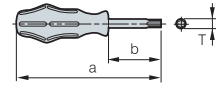
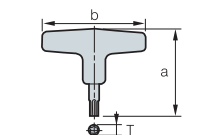
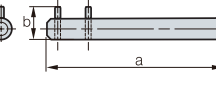
Spring

Geometry	Designation	Dimensions			
		a	b	c	d
	SR2	4.0	2.8	12.6	0.4
	SPR0315	3.0	15		
	SPR0415	4.0	15		
	SR3	9.2	12.5		
	SR4	4.0	11.0		
	SPR0714	7	14		
	SPR0510	5	10		
	SPR0714	7	14		
	SPR0811	8	11		

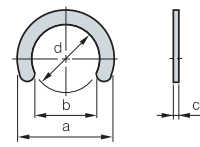
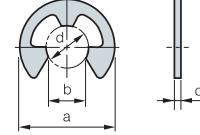
Wrench

Geometry	Designation	Dimensions		
		a	b	B(T)
	HW20L	52	18	2
	HW25L	58.5	20.5	2.5
	HW30L	66	23	3
	HW35L	72	25	3.5
	HW40L	74	29	4
	HW50L	85	33	5
	HW40	82	80	4
	HW50	96	90	5
	SW50L	70	27.5	
	TW06P	63	6	
	TW07P	63	7	
	TW08P	71	8	
	TW09P	75	9	
	TW10P	78	10	
	TW15P	82	15	
	TW20P	86	20	
	TW15L	60	21	15
	TW20L	60	21	20

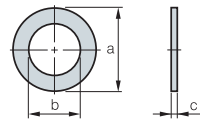
Wrench

Geometry	Designation	Dimensions		
		a	b	B(T)
	TW07S	140	60	7
	TW08S	150	76	8
	TW09S	165	70	9
	TW15S	190	90	15
	TW20S	195	91	20
	TW20	75	80	20
	TW25	74	80	25
	TW15-100	127	80	15
	TW20-100	127	80	20
	SW15S	150	13	

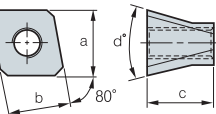
Stop ring

Geometry	Designation	Dimensions			
		a	b	c	d
	CR03	4.8	2.6	0.4	3.0
	CR04	6.6	3.6	0.4	4.0
	CR05	7.6	4.6	0.4	5.0
	ER03	7.0	2.6	0.6	3.0
	ER04	9.0	3.5	0.6	4.0
	ER05	11	4.3	0.6	5.0

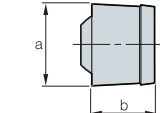
Washer

Geometry	Designation	Dimensions		
		a	b	c
	WA3	11.0	6.8	0.5-1.0
	WA4	10.0	5.3	0.5-1.0

Stopper

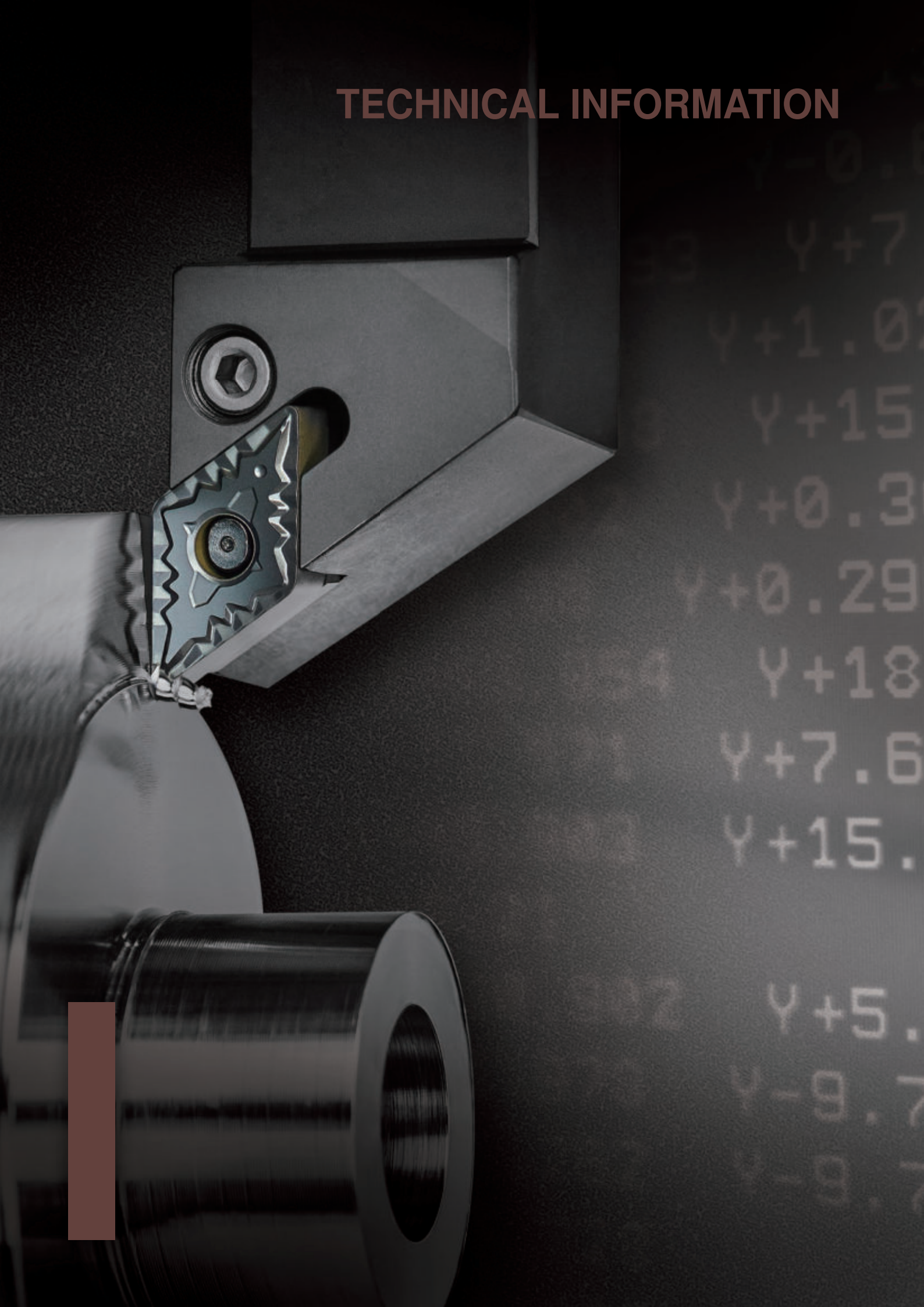
Geometry	Designation	Dimensions			
		a	b	c	d°
	STP5	11	10.2	11	30°

Nozzle

Geometry	Designation	Dimensions	
		a	b
	CN0605	6	4.6



TECHNICAL INFORMATION



General Information I

- I 02** Workpiece Material Grades
- I 06** Steel, Non-ferrous Metal
Symbol List
- I 07** SI unit Conversion Table
- I 08** Hardness Calculating Table
- I 09** Properties of Korloy Grades

Technical Information

- I 10** Technical Information for Turning
- I 20** Technical Information for Milling
- I 24** Technical Information for Tapers
- I 27** Technical Information for Endmills
- I 30** Technical Information for Drills

General Information II

- I 36** The comparison of chip breakers
- I 37** KORLOY Grades
- I 40** The comparison of grades for
Turning/Milling

General Information I

Carbon steel and alloy steel for structural use

Type	Korea	ISO	Japan	U.S.A	Great Britain	Germany	France	Russia	
	KS	ISO	JIS	AISI SAE	BS BS/EN	DIN DIN/EN	NF NF/EN	GOCT	
Carbon steel	SM10C	C10	S10C	1010	040A10 045A10 045M10	C10E C10R	XC10	-	
	SM15C	C15E4 C15M2	S15C	1015	055M15	C15E C15R	-	-	
	SM20C	-	S20C	1020	070M20 C22, C22E C22R	C22 C22E C22R	C22 C22E C22R	-	
	SM25C	C25 C25E4 C25M2	S25C	1025	C25 C25E C25R	C25 C25E C25R	C25 C25E C25R	-	
	SM30C	C30 C30E4 C30M2	S30C	1030	080A30 080M30 CC30 C30E C30R	C30 C30E C30R	C30 C30E C30R	30 Г	
	SM35C	C35 C35E4 C35M2	S35C	1035	C35 C35E C35R	C35 C35E C35R	C35 C35E C35R	35 Г	
	SM40C	C40 C40E4 C40M2	S40C	1039 1040	080M40 C40 C40E C40R	C40 C40E C40R	C40 C40E C40R	40 Г	
	SM43C	-	S43C	1042 1043	080A42	-	-	40 Г	
	SM45C	C45 C45E4 C45M2	S45C	1045 1046	C45 C45E C45R	C45 C45E C45R	C45 C45E C45R	45 Г	
	SM48C	-	S48C	-	080A47	-	-	45 Г	
	SM50C	C50 C50E4 C50M2	S50C	1049	080M50 C50 C50E C50R	C50 C50E C50R	C50 C50E C50R	50 Г	
	SM53C	-	S53C	1050 1053	-	-	-	50 Г	
	SM55C	C55 C55E4 C55M2	S55C	1055	070M55 C55 C55E C55R	C55 C55E C55R	C55 C55E C55R	-	
	SM58C	C60 C60E4 C60M2	S58C	1059 1060	C60 C60E C60R	C60 C60E C60R	C60 C60E C60R	60 Г	
Alloy steel	Nickel chromium steel	SNC236	-	SNC236	-	-	-	40XH	
		SNC415(H)	-	SNC415(H)	-	-	-	-	
		SNC631(H)	-	SNC631(H)	-	-	-	30XH3A	
		SNC815(H)	15NiCr13	SNC815(H)	-	655M13(655H13)	15NiCr13	-	
		SNC836	-	SNC836	-	-	-	-	
	Nickel chromium molybdenum steel	SNCM220	20NiCrMo2 20NiCrMoS2	SNCM220	8615 8617(H) 8620(H) 8622(H)	805A20 805M20 805A22 805M22	20NiCrMo2 20NiCrMoS2	20NCD2	-
		SNCM240	41CrNiMo2 41CrNiMoS2	SNCM240	8637 8640	-	-	-	
		SNCM415	-	SNCM415	-	-	-	-	
		SNCM420(H)	-	SNCM420(H)	4320(H)	-	-	-	
		SNCM431	-	SNCM431	-	-	-	-	
		SNCM439	-	SNCM439	4340	-	-	-	
		SNCM447	-	SNCM447	-	-	-	-	
		SNCM616	-	SNCM616	-	-	-	-	
		SNCM625	-	SNCM625	-	-	-	-	
		SNCM630	-	SNCM630	-	-	-	-	
	SNCM815	-	SNCM815	-	-	-	-		
Chromium steel	SCr415(H)	-	SCr415(H)	-	-	17Cr3 17CrS3	-	15X 15XA	
	SCr420(H)	20Cr4(H) 20CrS4	SCr420(H)	5120(H)	-	-	-	20X	
	SCr430(H)	34Cr4 34CrS4	SCr430(H)	5130(H) 5132(H)	34Cr4 34CrS4	34Cr4 34CrS4	34Cr4 34CrS4	30X	
	SCr435(H)	34Cr4 34CrS4 37Cr4 37CrS4	SCr435(H)	5135(H)	37Cr4 37CrS4	37Cr4 37CrS4	37Cr4 37CrS4	35X	
	SCr440(H)	37Cr4 37CrS4 41Cr4 41CrS4	SCr440(H)	5140(H)	530M40 41Cr4 41CrS4	41Cr4 41CrS4	41Cr4 41CrS4	40X	
	SCr445(H)	-	SCr445(H)	-	-	-	-	45X	

• The above Alloy steel can supplied by domestic manufacturing



Type		Korea	ISO	Japan	U.S.A	Great Britain	Germany	France	Russia
		KS	ISO	JIS	AISI SAE	BS BS/EN	DIN DIN/EN	NF NF/EN	GOCT
Alloy steel	Chromium molybdenum steel	SCM415(H)	-	SCM415(H)	-	-	-	-	-
		SCM418(H)	18CrMo4 18CrMoS4	SCM418(H)	-	-	18CrMo4 18CrMoS4	-	20XM
		SCM420(H)	-	SCM420(H)	-	708M20(708H20)	-	-	20XM
		SCM430	-	SCM430	4130	-	-	-	30XM 30XMA
		SCM432	-	SCM432	-	-	-	-	-
		SCM435(H)	34CrMo4 34CrMoS4	SCM435(H)	(4135H) 4137(H)	34CrMo4 34CrMoS4	34CrMo4 34CrMoS4	34CrMo4 34CrMoS4	35XM
		SCM440(H)	42CrMo4 42CrMoS4	SCM440(H)	4140(H) 4142(H)	708M70 709M40 42CrMo4 42CrMoS4	42CrMo4 42CrMoS4	42CrMo4 42CrMoS4	-
		SCM445(H)	-	SCM445(H)	4145(H) 4147(H)	-	-	-	-
	Manganese steel and Manganese chromium steel	SMn420(H)	22Mn6(H)	SMn420(H)	1522(H)	150M19	-	-	-
		SMn433(H)	-	SMn433(H)	1534	150M36	-	-	30 Г 2 35 Г 2 35 Г 2 40 Г 2 40 Г 2 45 Г 2
		SMn438(H)	36Mn6(H)	SMn438(H)	1541(H)	150M36	-	-	-
		SMn443(H)	42Mn6(H)	SMn443(H)	1541(H)	-	-	-	-
		SMnC420(H)	-	SMnC420(H)	-	-	-	-	-
		SMnC443(H)	-	SMnC443(H)	-	-	-	-	-
	Aluminum chromium molybdenum steel	SACM645	41CrAlMo74	SACM645	-	-	-	-	-

• The above Alloy steel can supplied by domestic manufacturing

Tool steel

Type		Korea	ISO	Japan	U.S.A	Great Britain	Germany	France	Russia	
		KS	ISO	JIS	AISI SAE	BS BS/EN	DIN DIN/EN	NF NF/EN	GOCT	
High speed steel	SKH2	HS18-0-1	SKH2	T1	BM 2	S6/5/2	Z 85 WDCV			
	SKH3	-	SKH3	T4						
	SKH4	-	SKH4	T5						
	SKH10	-	SKH10	T15						
	SKH51	HS6-5-2	SKH51	M2						
	SKH52	HS6-6-2	SKH52	M3-1	BM 35	S6/5/2/5	6-5-2-5			
	SKH53	HS6-5-3	SKH53	M3-2						
	SKH54	HS6-5-4	SKH54	M4						
	SKH55	HS6-5-2-5	SKH55	M 35						
	SKH56	-	SKH56	M36						
	SKH57	HS10-4-3-10	SKH57	-	S2/9/2					
	SKH58	HS2-9-2	SKH58	M7						
	SKH59	HS2-9-1-8	SKH59	M42						
	Alloy tool steel	STS11	-	SKS11	F2					
STS2		-	SKS2	-						
STS21		-	SKS21	-						
STS5		-	SKS5	-						
STS51		-	SKS51	L6						
STS7		-	SKS7	-						
STS8		-	SKS8	-						
STS4		-	SKS4	-						
STS41		-	SKS41	-						
STS43		105V	SKS43	W2-9 1/ W2-8 1-2						
STS44		-	SKS44	-						
STS3		-	SKS3	-	105WCr6					105WC13
STS31		105WCr1	SKS31	-	BD3	X210Cr12	Z200C12			
STS93		-	SKS93	-						
STS94		-	SKS94	-						
STS95		-	SKS95	-						
STD1		210Cr12	SKD1	D3				BA2	X100CrMoV5 1	Z100CDV5
STD11		-	SKD11	D2						
STD12		100CrMoV5	SKD12	A2				BH21	X30WCrV9 3	Z30WCv9
STD4		-	SKD4	-						
STD5		X30WCrV9-3	SKD5	H21				BH13	X40CrMoV5 1	Z40CDV5
STD6		X37CrMoV5-1	SKD6	H11						
STD61		X40CrMoV5-1	SKD61	H13						
STD62		X35CrWMoV5	SKD62	H12						
STD7	32CrMoV12-28	SKD7	H10							
STD8	-	SKD8	H19							
STF3	-	SKT3	-	55NiCrMoV6	55NCDV7					
STF4	55NiCrMoV7	SKT4	L6							

• The above Alloy steel can supplied by domestic manufacturing



General Information I

Type	Korea	ISO	Japan	U.S.A	Great Britain	Germany	France	Russia
	KS	ISO	JIS	AISI SAE	BS BS/EN	DIN DIN/EN	NF NF/EN	GOCT
Free cutting carbon steel	SUM11	-	SUM11	1110				
	SUM12	-	SUM12	1109				
	SUM21	9S20	SUM21	1212				
	SUM22	11SMn28	SUM22	1213	230M07	9SMn28	S250	
	SUM22L	11SMnPb28	SUM22L	12L13		9SMnPb28	S250Pb	
	SUM23	-	SUM23	1215	240M07	9SMn36	S 300	
	SUM23L	-	SUM23L	-				
	SUM24L	11SMnPb28	SUM24L	12L14		9SMnPb36	S300Pb	
	SUM25	12SMn35	SUM25	-				
	SUM31	-	SUM31	1117				
	SUM31L	-	SUM31L	-				
	SUM32	-	SUM32	-				
	SUM41	-	SUM41	1137				
	SUM42	-	SUM42	1141				
	SUM43	44SMn28	SUM43	1144				
High carbon chromiom	STB1	-	SUJ1	-				
	STB2	B1	SUJ2	52100	534A99	100Cr6	100Cr6	
	STB3	B2	SUJ3	ASTM A 485 Grade 1				
	STB4	-	SUJ4	-				
	STB5	-	SUJ5	-				

• The above Alloy steel can supplied by domestic manufacturing

Stainless steel

Type		Korea	ISO	Japan	U.S.A		Great Britain	Germany	France	Russia	
		KS	ISO	JIS	UNS	AISI SAE	BS BS/EN	DIN DIN/EN	NF NF/EN	GOCT	
Stainless steel	Austenitic	STS201	X12CrMnNiN17-7-5	SUS201	S20100	201	284S16	X12CrNi17-7	Z12CMN17-07Az	12X17-9AH4	
		STS202	X12CrMnNiN18-9-5	SUS202	S20200	202	301S21	X2CrNiN18-7		07X16H6	
		STS301	X10CrNi18-8	SUS301	S30100	301			X12CrNi17-7	Z11CN17-08	
		STS301L	X2CrNiN18-7	SUS301L							
		STS301J1		SUS301J1			302S25				12X18H9
		STS302		SUS302	S30200	302			X10CrNiS18-9	Z12CN18-09	
		STS302B	X12CrNiSi18-9-3	SUS302B	S30215	302B	303S21				
		STS303	X10CrNiS18-9	SUS303	S30300	303	303S41			Z8CNF18-09	12X18H10E
		STS303Se		SUS303Se	S30323	303Se			X5CrNi18-10		
		STS303Cu		SUS303Cu			304S31				08X18H10
		STS304	X5CrNi18-9 X2CrNi18-9	SUS304	S30400	304		304S11	X2CrNi19-11	Z7CN18-09	03X18H11
		STS304L	X2CrNi19-11	SUS304L	S30403	304L			X2CrNiN18-10	Z3CN19-11	
		STS304N1	X5CrNiN18-8	SUS304N1	S30451	304N				Z6CN19-09Az	
		STS304LN	X2CrNiN18-8	SUS304LN	S30453	304LN			X5CrNi18-12	Z3CN18-10Az	
		STS304J1		SUS304J1			305S19				06X18H11
		STS305	X6CrNi18-12	SUS305	S30500	305				Z8CN18-12	
		STS309S		SUS309S	S30908	309S	310S31		X5CrNiMo27-12-2	Z10CN24-13	10X23H18
		STS310S	X6CrNi25-20	SUS310S	S31008	310S	316S31		X5CrNiMo27-13-3	Z8CN25-20	
		STS316	X5CrNiMo17-12-2 X3CrNiMo17-12-3	SUS316	S31600	316		316S11	X2CrNiMo17-13-2 X2CrNiMo17-14-3	Z7CND17-12-02 Z6CND18-12-03	03X17H14M3
		STS316L	X2CrNiMo17-12-2 X2CrNiMo17-12-3 X2CrNiMo18-14-3	SUS316L		316L				Z3CND17-12-02 Z3CND17-12-03	
	STS316N		SUS316N	S31651	316N	317S16		X6CrNiTi18-10			
	STS317		SUS317	S31700	317	321S31		X6CrNiNb18-10		08X18H10T	
	STS321	X6CrNiTi18-10	SUS321	S32100	321	347S31			Z6CNT18-10	08X18H12	
	STS347	X6CrNiNb18-10	SUS347	S34700	347			X6CrAl13	Z6CNCNb18-10		
	STS384	X3NiCr18-16	SUS384	S38400	384	405S17			Z6CN18-16		
	STS405	X6CrAl13	SUS405	S40500	405				Z8CA12		
	STS410L		SUS410L					X6Cr17	Z3C14		
	STS429		SUS429	S42900	429	430S17		X7CrS18		12X17	
	STS430	X6Cr17	SUS430	S43000	430			X6CrMo17-1	Z8C17		
	STS430F	X7CrS17	SUS430F	S43020	430F	434S17			Z8CF17		
	STS434	X6CrMo17-1	SUS434	S43400	434				Z8CD17-01		
	STS444	X2CrMoTi18-2	SUS444	S44400	444				Z3CDT18-02		
	STXCM27		SUSXM27	S44627				X10Cr13	Z1CD26-01		
Martensitic	STS403		SUS403	S40300	403	410S21					
	STS410	X12Cr13	SUS410	S41000	410	416S21	X20Cr13	Z13C13			
	STS416	X12CrS13	SUS416	S41600	416	420S29	X20CrNi17-2	Z11CF13	20X13		
	STS420J1	X20Cr13	SUS420J1	S42000	420	431S29		Z20C13	20X17H2		
	STS431	X19CrNi16-2	SUS431	S43100	431				Z15CN16-02		
STS440A	X70CrMo15	SUS440A	S44002	440A			X7CrNiAl17-7	Z70C15			
Precipitation hardening type	STS630	X5CrNiCuNb16-4	SUS630	S17400	S17400				Z6CNU17-04	09X17H7IO	
	STS631	X7CrNiAl17-7	SUS631	S17700	S17700				Z9CNA17-07		
STS631J1		SUS631J1									

• The above Alloy steel can supplied by domestic manufacturing



➤ Casting or forging steel

Type		Korea	ISO	Japan	U.S.A	Great Britain	Germany	France	Russia
		KS	ISO	JIS	AISI SAE	BS BS/EN	DIN DIN/EN	NF NF/EN	GOCT
Casting Iron	Grey iron casting	GC100 GC150 GC200 GC250 GC300 GC350	100, 150, 200, 250, 300, 350	FC100 FC150 FC200 FC250 FC300 FC350	No 20 B No 25 B No 30 B No 35 B No 45 B No 50 B No 55 B	Grade 150 Grade 220 Grade 260 Grade 300 Grade 350 Grade 400	GG 10 GG 15 GG 20 GG 25 GG 30 GG 35 GG 40	Ft 10 D Ft 15 D Ft 20 D Ft 25 D Ft 30 D Ft 35 D Ft 40 D	
	Spheroidal graphite iron casting	GCD400-15, GCD400-18 GCD450-10, GCD500-7 GCD600-3 GCD700-2	400-15, 400-18 450-10, 500-7 600-3 700-2	FCD400 FCD500 FCD600 FCD700	60-40-18 65-45-12 80-55-06 100-70-03	SNG 420/12 SNG 370/17 SNG 500/7 SNG 600/3 SNG 700/2	GGG 40 GGG 40.3 GGG 50 GGG 60 GGG 70	FCS 400-12 FGS 370-17 FGS 500-7 FGS 600-3 FGS 700-2	
	Austempered Spheroidal graphite iron casting	FCAD	-	FCAD	-	EN-GJS-	EN-GJS-	EN-GJS-	
	Austenitic iron casting	FCA- FCDA-	L, S-	FCA- FCDA-	Type 1, 2, Type D-2, D-3A Class 1, 2	F1, F2, S2W, S5S	GGL-, GGG-	L, S-	

➤ Non-ferrous alloy

Type		Korea	ISO	Japan	U.S.A	Great Britain	Germany	France	Russia
		KS	ISO	JIS	AISI SAE	BS BS/EN	DIN DIN/EN	NF NF/EN	GOCT
Aluminum alloy	Aluminum alloy ingots for casting	AC1B	Al-Cu4MgTi	AC1B	204.0	-	-	A-U5GT	
		AC2A	-	AC2A	-	-	-	-	
		AC2B	-	AC2B	319.0	-	-	-	
		AC3A	-	AC3A	-	-	LM-6	-	
		AC4A	-	AC4A	-	-	-	G(GK)-AlSi9Cu3	-
		AC4B	-	AC4B	-	-	-	-	-
		AC4C	Al-Si7Mg(Fe)	AC4C	356.0	LM-25	G(GK)-AlSi7MG	A-S7G	
		AC4CH	Al-Si7Mg	AC4CH	A356.0	-	-	-	
		AC4D	Al-Si5Cu1Mg	AC4D	355.0	LM-16	-	-	
		AC5A	Al-Cu4Ni2Mg2	AC5A	242.0	-	G(GK)-AlMg5	A-U4NT	
		AC7A	-	AC7A	514.0	LM-5	-	-	
		AC8A	-	AC8A	-	LM-13	-	-	A-S12UNG
		AC8B	-	AC8B	-	LM-26	-	-	A-S10UG
		AC8C	-	AC8C	-	-	-	-	A-S10UG
	AC9A	-	AC9A	-	LM-29	-	-	-	
	AC9B	-	AC9B	-	-	-	GD-AlSi12 (Cu)	A-S18UNG	
	Aluminum alloy die casting	ALDC1	Al-Si12CuFe	ADC1	A413.0	LM20	GD-AlSi10Mg	A-S13	
		ALDC2	-	ADC3	A360.0	-	GD-AlMg9	A-S9G	
		ALDC3	-	ADC5	518.0	-	-	A-G6	
		ALDC4	-	ADC6	-	-	-	-	
		ALDC7	Al-Si8Cu3Fe	ADC10	A380.0	-	GD-AlSi9Cu3	A-G3T	
		ALDC7Z	Al-Si8Cu3Fe	ADC10Z	A380.0	LM24	-	-	
		ALDC8	-	ADC12	383.0	LM2	-	-	
	ALDC8Z	-	ADC12Z	383.0	LM2	-	-		
	ALDC9	-	ADC14	B390.0	LM30	EN AW-5052	-		
	Aluminum alloy extruded shapes	A5052S	-	A5052S	5052	EN AW-5052	EN AW-5454	EN AW-5052	
		A5454S	-	A5454S	5454	EN AW-5454	EN AW-5083	EN AW-5454	
A5083S		AlMg4.5Mn0.7	A5083S	5083	EN AW-5083	EN AW-5086	EN AW-5083		
A5086S		-	A5086S	5086	EN AW-5086	EN AW-6061	EN AW-5086		
A6061S		AlMg1SiCu	A6061S	6061	EN AW-6061	EN AW-6063	EN AW-6061		
A6063S		AlMg0.7Si	A6063S	6063	EN AW-6063	EN AW-7003	EN AW-6063		
A7003S		-	A7003S	-	EN AW-7003	-	EN AW-7003		
A7N01S		-	A7N01S	-	-	EN AW-7075	-		
A7075S		AlZn5.5MgCu	A7075S	7075	EN AW-7075	-	EN AW-7075		

➤ Heat resistant steel

Type		Korea	ISO	Japan	U.S.A		Great Britain	Germany	France	Russia	
		KS	ISO	JIS	UNS	AISI SAE	BS BS/EN	DIN DIN/EN	NF NF/EN	GOCT	
Heat resistant steel	Austenitic	STR31		SUH31			331S42		Z35CNWS14-14		
		STR35		SUH35			349S52	X53CrMnNi21-9	Z52CMN21-09-Az		
		STR36		SUH36			349S54		Z55CMN21-09-Az		
		STR37		SUH37		S63008	381S34				
		STR38		SUH38		S63017					
		STR309		SUH309				309S24	CrNi2520	Z15CN24-13	
		STR310		SUH310		S30900		310S24		Z15CN25-20	
		STR330		SUH330		S31000	309			Z12NCS35-16	
		STR660		SUH660		N08330	310			Z6NCTV25-20	
		STR661		SUH661		S66286	N08330		CrAl1205		
	Ferritic	STR21		SUH21		R30155		X6CrTi12			
		STR409	X6CrTi12	SUH409			409S19		Z6CT12		
		STR409L	X2CrTi12	SUH409L		S40900			Z3CT12		
		STR446		SUH446			409	X45CrSi9-3	Z12C25		
	Martensitic	STR1		SUH1		S44600		401S45	Z45CS9		
		STR3		SUH3		S65007	446		Z40CSD10		
		STR4		SUH4				443S65	Z80CSN20-02		
		STR11		SUH11							
		STR600		SUH600							
		STR616		SUH616		S42200					

• The above Heat resistant steel can supplied by domestic manufacturing



Steel, Non-ferrous metal symbol list

Comparison of workpiece material standards

Group	Standard term	Code	Group	Standard term	Code	
Structural Steel	Rolled Steel for Welded Structure	SWS	Forged steel	Carbon Steel Forging	SF	
	Rerolled Steel	SBR		Chromium Molybdenum Steel Forging	SFCM	
	Rolled Steel for General Structure	SB		Nickel Chromium Molybdenum Steel Forging	SFNCM	
	Light Gauge Steel for General Structure	SBC	Cast iron	Gray Cast iron	GC	
	Hot-rolled Steel Plate, Sheet/ Strip for Automobile Structural Use	SAPH		Spheroidal Graphite Cast iron	GCD	
Steel Plate	Cold-rolled Steel Sheet/Strip	SBC		Blackheart Malleable Cast iron	BMC	
	Hot-rolled Soft Steel Sheet/Strip	SHP		Whiteheat Malleable Cast iron	WMC	
Steel Pipe	Carbon Steel Pipe for Ordinary Piping	SPP	Pearlitic Malleable Cast iron	PMC		
	Carbon Steel Pipe for Boiler and Heat Exchanger	STH	Cast steel	Carbon Cast Steel	SC	
	Seamless Steel Pipe for High Pressure Gas Cylinder	STHG		High Tensile Strength Carbon Cast Steel & Low Alloy Cast Steel	HSC	
	Carbon Steel Pipe for General Structural Use	SPS		Stainless Cast Steel	SSC	
	Carbon Steel Pipe for Machine Structural Use	STST		Heat Resisting Cast Steel	HRSC	
	Alloy Steel Pipe for Structural Use	STA		High Manganese Cast Steel	HMnSC	
	Stainless Steel Pipe for Machine and Structural Use	STS-TK		Cast Steel for High Temperature and High Pressure Service	SCPH	
	Carbon Steel Square Pipe for General Structural Use	SPSR		Casting	Brass Casting	BsC
	Alloy Steel Pipe	SPA			High Strength Brass Casting	HBsC
	Carbon Steel Pipe for Pressure Service	SPPS	Bronze Casting		BrC	
	Carbon Steel Pipe for High Temperature Service	SPSR	Phosphoric Bronze Casting		PCB	
	Carbon Steel Pipe for High Pressure Service	SPPH	Aluminum Bronze Casting		AIBC	
	Stainless Steel Pipe	STSxT	Aluminum Alloy Casting		ACxA	
	Iron and Steel	Carbon Steel for Machine Structural Use	SMxxC, SMxxCK		Magnesium Alloy Casting	MgC
		Aluminum Chromium Molybdenum Steel	SACM		Zinc Alloy Die Casting	ZnDC
Chromium Molybdenum Steel		SCM	Aluminum Alloy Die Casting		Al DC	
Chromium Steel		SCr	Magnesium Alloy Die Casting		MgDC	
Nickel Chromium Steel		SNC	White Metal	WM		
Nickel Chromium Molybdenum Steel		SNCM	Aluminum Alloy Casting for Bearing	AM		
Manganese Steel and manganese Chromium Steel for Machine Structural Use		SMn, SMnC	Brass Alloy Casting for Bearing	KM		
Special steel	Tool steel	Carbon Tool Steel	STC			
		Hollow Drill Steel	SKC			
		Alloy Tool Steel	STS, STD, STF			
		High Speed Tool Steel	SKH			
	Stainless steel	Stainless Steel Bar	STS			
		Heat resisting steel	Heat Resisting Steel	STR		
			Heat Resisting Steel Bar	STR		
	Heat Resisting Steel Sheet		STR			
	Free cutting carbon steel	SUM				
	Special steel	STB				
Spring steel	SPS					



SI unit conversion table

Major SI unit conversion table

Force

N	kgf	dyn
1	1.01972×10^{-1}	1×10^{-5}
9.80665	1	9.80665×10^5
1×10^{-5}	1.01972×10^{-6}	1

Stress

Pa or N/m ²	MPa or N/mm ²	kgf/mm ²	kgf/cm ²	kgf/m ²
1	1×10^{-6}	1.01972×10^{-7}	1.01972×10^{-5}	1.01972×10^{-1}
1×10^6	1	1.01972×10^{-1}	1.01972×10	1.01972×10^5
9.80665×10^6	9.80665	1	1×10^2	1×10^6
9.80665×10^4	9.80665×10^{-2}	1×10^{-2}	1	1×10^4
9.80665	9.80665×10^{-6}	1×10^{-6}	1×10^{-4}	1

Pressure

Pa	kPa	MPa	bar	kgf/cm ²
1	1×10^{-3}	1×10^{-6}	1×10^{-5}	1.01972×10^{-5}
1×10^3	1	1×10^{-3}	1×10^{-2}	1.01972×10^{-2}
1×10^6	1×10^3	1	1×10	1.01972×10
1×10^5	1×10^2	1×10^{-1}	1	1.01972
9.80665×10^4	9.80665×10	9.80665×10^{-2}	9.80665×10^{-1}	1

Work, Energy, Calorie

J	kW·h	kgf·m	kcal
1	2.77778×10^{-7}	1.01972×10^{-1}	2.38889×10^{-4}
3.60000×10^6	1	3.67098×10^5	8.60000×10^2
9.80665	2.72407×10^{-6}	1	2.34270×10^{-3}
4.18605×10^3	1.16279×10^{-3}	4.26858×10^2	1

Power

W	kW	kgf·m/s	PS	kcal/h
1	1×10^{-3}	1.01972×10^{-1}	1.35962×10^{-3}	0.860
1×10^3	1	1.01972×10^2	1.359 62	8.60000×10^2
9.81 65	9.80665×10^{-3}	1	1.33333×10^{-2}	8.433 71
7.355×10^2	7.355×10^{-1}	7.5×10	1	6.32529×10^2
1.16279	1.16279×10^{-3}	1.18572×10^{-1}	1.58095×10^{-3}	1

Specific heat

J/(kg·K)	kcal/(kg·°C) cal/(g·°C)
1	2.38889×10^{-4}
4.18605×10^3	1

Thermal conductivity

W/(m·K)	kcal/(h·m·°C)
1	8.6000×10^{-1}
1.16279	1

Revolution per minute

min ⁻¹	s ⁻¹	r.p.m.
1	0.0167	1
60	1	60

Hardness calculating table

Work piece hardness calculating table

Vickers 50kgf HV	Brinell 3000kgf HB		Rockwell				Shore HS	Tensile strength (approximate value) MPa (t)
	Standard ball 10mm	Cemented carbide ball 10mm	A scale 60kgf Diamond particle HRA	B scale 100kgf 1/16in ball HRB	C scale 150kgf Diamond particle HRC	D scale 100kgf Diamond particle HRD		
940	-	-	85.6	-	68.0	76.9	97	
920	-	-	85.3	-	67.5	76.5	96	
900	-	-	85.0	-	67.0	76.1	95	
880	-	(767)	84.7	-	66.4	75.7	93	
860	-	(757)	84.4	-	65.9	75.3	92	
840	-	(745)	84.1	-	65.3	74.8	91	
820	-	(733)	83.8	-	64.7	74.3	90	
800	-	(722)	83.4	-	64.0	74.8	88	
780	-	(710)	83.0	-	63.3	73.3	87	
760	-	(698)	82.6	-	62.5	72.6	86	
740	-	(684)	82.2	-	61.8	72.1	84	
720	-	(670)	81.8	-	61.0	71.5	83	
700	-	(656)	81.3	-	60.1	70.8	81	
690	-	(647)	81.1	-	59.7	70.5	-	
680	-	(638)	80.8	-	59.2	70.1	80	
670	-	630	80.6	-	58.8	69.8	-	
660	-	620	80.3	-	58.3	69.4	79	
650	-	611	80.0	-	57.8	69.0	-	
640	-	601	79.8	-	57.3	68.7	77	
630	-	591	79.5	-	56.8	68.3	-	
620	-	582	79.2	-	56.3	67.9	75	
610	-	573	78.9	-	55.7	67.5	-	
600	-	564	78.6	-	55.2	67.0	74	
590	-	554	78.4	-	54.7	66.7	-	2055
580	-	545	78.0	-	54.1	66.2	72	2020
570	-	535	77.8	-	53.6	65.8	-	1985
560	-	525	77.4	-	53.0	65.4	71	1950
550	(505)	517	77.0	-	52.3	64.8	-	1905
540	(496)	507	76.7	-	51.7	64.4	69	1860
530	(488)	497	76.4	-	51.1	63.9	-	1825
520	(480)	488	76.1	-	50.5	63.5	67	1795
510	(473)	479	75.7	-	49.8	62.9	-	1750
500	(465)	471	75.3	-	49.1	62.2	66	1705
490	(456)	460	74.9	-	48.4	61.6	-	1660
480	488	452	74.5	-	47.7	61.3	64	1620
470	441	442	74.1	-	46.9	60.7	-	1570
460	433	433	73.6	-	46.1	60.1	62	1530
450	425	425	73.3	-	45.3	59.4	-	1495
440	415	415	72.8	-	44.5	58.8	59	1460
430	405	405	72.3	-	43.6	58.2	-	1410
420	397	397	71.8	-	42.7	57.5	57	1370
410	388	388	71.4	-	41.8	56.8	-	1330
100	379	379	70.8	-	40.8	56.0	55	1290
390	369	369	70.3	-	39.8	55.2	-	1240
380	360	360	69.8	(100.0)	38.8	54.4	52	1205
370	350	350	69.2	-	39.9	53.6	-	1170
360	341	341	68.7	(109.0)	36.6	52.8	50	1130
350	331	331	68.1	-	35.5	51.9	-	1095
340	322	322	67.6	(108.0)	34.4	51.1	47	1070
330	313	313	67.0	-	33.3	50.2	-	1035

Vickers 50kgf HV	Brinell 3000kgf HB		Rockwell				Shore HS	Tensile strength (approximate value) MPa (t)
	Standard ball 10mm	Cemented carbide ball 10mm	A scale 60kgf Diamond particle HRA	B scale 100kgf 1/16in ball HRB	C scale 150kgf Diamond particle HRC	D scale 100kgf Diamond particle HRD		
320	303	303	66.4	(107.0)	32.2	49.4	45	1005
310	294	294	65.8	-	31.0	48.4	-	980
300	284	284	65.2	(105.5)	29.8	47.5	42	950
295	280	280	64.8	-	29.2	47.1	-	935
290	275	275	64.5	(104.5)	28.5	46.5	41	915
285	270	270	64.2	-	27.8	46.0	-	905
280	265	265	63.8	(103.5)	27.1	45.3	40	890
275	261	261	63.5	-	26.4	44.9	-	875
270	256	256	63.1	(102.0)	25.6	44.3	38	855
265	252	252	62.7	-	24.8	43.7	-	840
260	247	247	62.4	(101.0)	24.0	43.1	37	825
255	243	243	62.0	-	23.1	42.2	-	805
250	238	238	61.6	99.5	22.2	41.7	36	795
245	233	233	61.2	-	21.3	41.1	-	780
240	228	228	60.7	98.1	20.3	40.3	34	765
230	219	219	-	96.7	(18.0)	-	33	730
220	209	209	-	95.0	(15.7)	-	32	695
210	200	200	-	93.4	(13.4)	-	30	670
200	190	190	-	91.5	(11.0)	-	29	635
190	181	181	-	89.5	(8.5)	-	28	605
180	171	171	-	87.1	(6.0)	-	26	580
170	162	162	-	85.0	(3.0)	-	25	545
160	152	152	-	81.7	(0.0)	-	24	515
150	143	143	-	78.7	-	-	22	490
140	133	133	-	75.0	-	-	21	455
130	124	124	-	71.2	-	-	20	425
120	114	114	-	66.7	-	-	-	390
110	105	105	-	62.3	-	-	-	-
100	95	95	-	56.2	-	-	-	-
95	90	90	-	52.0	-	-	-	-
90	86	86	-	48.0	-	-	-	-
85	81	81	-	41.0	-	-	-	-

Note) 1. 1MPa = 1N/mm²

2. The number in the blank is not generally used ranges



Properties of KORLOY grades

Physical properties of KORLOY grades

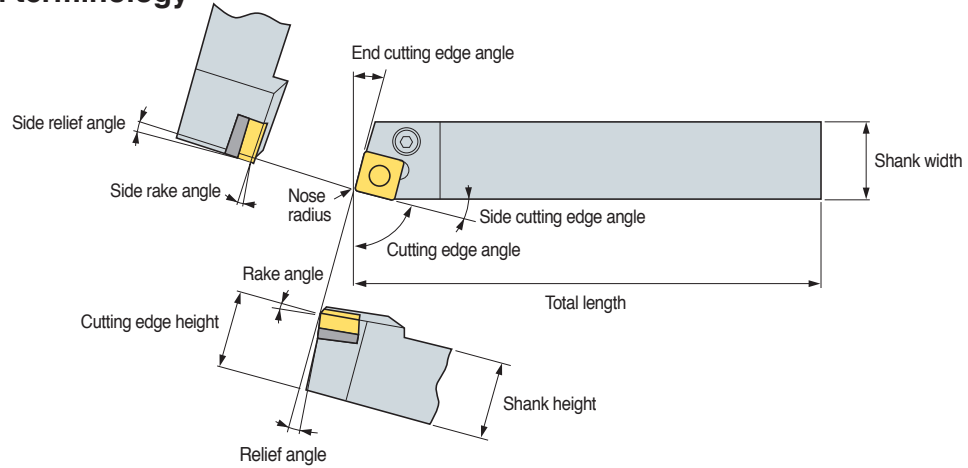
Application	ISO Classification symbol	KORLOY grades	Specific gravity (g/cm ³)	Hardness (HRA)	TRS (kgf/mm ²)	Compressive strength (kg/mm ²)	Young's modulus (10 ³ kgf/mm ²)	Thermal expansion coefficient (10 ⁻⁶ /°C)	Thermal conductivity (cal/cmsec°C)	
Grades for cutting tools	P	P01	ST05	10.6	92.7	140	440	-	-	-
		P10	ST10	10.0	92.1	175	460	48	6.2	25
		P20	ST20	11.8	91.9	200	480	56	5.2	42
		P30	ST30A	12.2	91.3	230	500	53	5.2	-
	M	M10	U10	12.9	92.4	170	500	47	-	-
		M20	U20	13.1	91.1	210	500	-	-	88
		M30	ST30A	12.2	91.3	230	500	53	5.2	-
		M40	U40	13.3	89.2	270	440	-	-	-
	K	K01	H02	14.8	93.2	185	-	61	4.4	105
		K10	H01	13.0	92.9	210	570	66	4.7	109
K20		G10	14.7	90.9	250	500	63	-	105	
Ultra fine grain alloy	Z	Z10	FA1	14.1	91.4	290	-	58	5.7	-
		Z20	FCC	12.5	91.3	235	-	-	-	-
Grade for tungsten carbide wear parts	V	V1	D1	15.0	92.3	205	520	-	-	-
		V2	D2	14.8	90.9	250	150	-	-	-
		V3	D3	14.6	89.7	310	410	-	-	-
		V4	G5	14.3	89.0	320	380	-	-	-
		V5	G6	14.0	87.7	350	330	-	-	-
Grade for mining and civil engineering tools	E	E1	GR10	14.8	90.9	220	-	-	-	-
		E2	GR20	14.8	90.3	240	-	-	-	-
		E3	GR30	14.8	89.0	270	-	-	-	-
		E4	GR35	14.8	88.2	270	-	-	-	-
		E5	GR50	14.5	87.0	300	-	-	-	-

The physical properties of element

Element	Specific gravity (g/cm ³)	Hardness (HB)	Young's modulus (×10 ³ kgf/mm ²)	Thermal conductivity (cal/cmsec°C)	Thermal expansion coefficient (×10 ⁻⁶ /°C)	Melting point (°C)
WC	15.6	2,150	70	0.3	5.1	2,900
TiC	4.94	3,200	45	0.04	7.6	3,200
TaC	14.5	1,800	29	0.05	6.6	3,800
NbC	8.2	2,050	35	0.04	6.8	3,500
TiN	5.43	2,000	26	0.07	9.2	2,950
Al ₂ O ₃	3.98	3,000	42	0.07	8.5	2,050
cBN	3.48	4,500	71	3.1	4.7	-
Diamond	3.52	9,000	99	5.0	3.1	-
Co	8.9	-	10~18	0.165	12.3	1,495
Ni	8.9	-	20	0.22	13.3	1,455

Technical Information for Turning

Insert shape and terminology

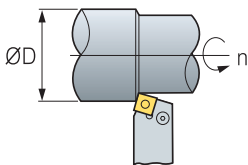


Relating angles between tool and workpiece

Cutting edge inclination	Terminology	Function	Effect
Rake angle	Side rake angle Rake angle	• Cutting force, Cutting heat, The effects of chip control on tool life	<ul style="list-style-type: none"> • (+): Excellent machine-ability(reducing cutting force, weakening cutting edge strength) • (+): When machining excellent machine-ability or thin workpiece • (-): When strong cutting edge is needed at interrupted condition or mill scale
Relief angle	Relief angle Side relief angle	• Only cutting edge contact with cutting face	• (-): Cutting edge is strong but has short tool life to make bad influence on flank wear
Cutting edge angle	Cutting edge angle	• Affects chip control and cutting force direction	• (+): Improved chip control because chip thickness is big
	Side cutting edge angle	• Affects chip control and cutting force direction	<ul style="list-style-type: none"> • (+): Strong cutting edge due to distributed cutting force but chip control is bad by thin chip thickness • (-): Improved chip performance
	End cutting edge angle	• Prevent friction between cutting edge and cutting face	• (-): Cutting edge is strong but has short tool life to make bad influence on flank wear

Calculation formulas for machining

Cutting speed



$$vc = \frac{\pi \times D \times n}{1000} \text{ (m/min)}$$

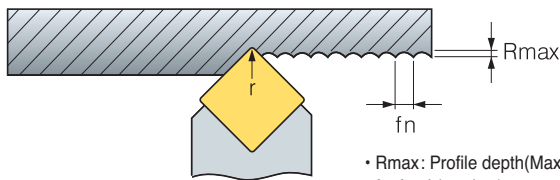
- vc: Cutting speed (m/min)
- D: Diameter (mm)
- n: Revolution per minute (min⁻¹)
- π: Circular constant (3.14)

Feed

$$fn = \frac{vf}{n} \text{ (mm/rev)}$$

- fn: Feed per revolution (mm/rev)
- vf: Table feed (mm/min)
- n: Revolution per minute (min⁻¹)

Surface finish



- Rmax: Profile depth(Maximum height roughness) (μ)
- fn: feed (mm/rev)
- r: nose radius

Theoretical surface roughness

$$R_{max} = \frac{fn^2}{8r} 1000 (\mu\text{m})$$

Practical surface roughness

- Steel: $R_{max} \times (1.5\sim3)$
- Cast iron: $R_{max} \times (3\sim5)$

Power requirement

$$P_{kw} = \frac{Q \times kc}{60 \times 102 \times \eta}$$

$$P_{HP} = \frac{P_{kw}}{0.75}$$

$$Q = \frac{vc \times fn \times ap}{1000}$$

- P_{kw}: Power requirement [kW]
- P_{HP}: Power requirement (horse power) [HP]
- vc: Cutting speed [m/min]
- ap: Depth of cut [mm]
- fn: Feed per revolution [mm/rev]
- kc: Specific cutting resistance [kg/mm²]
- η: Machine efficiency rate (0.7~0.8)

Rough Kc

Mild steel	190
Medium carbon steel	210
High carbon steel	240
Low alloy steel	190
High alloy steel	245
Cast iron	93
Malleable cast iron	120
Bronze, Brass	70

Material removal rate

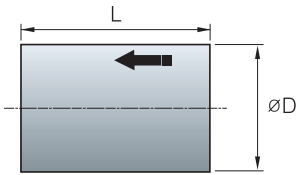
$$Q \text{ (cm}^3\text{/min)} = vc \times ap \times fn$$

- Q: Material removal rate [cm³/min]
- ap: Depth of cut [mm]
- vc: Cutting speed [m/min]
- fn: Feed per revolution [mm/rev]



● Machining time

External face machining 1



Constant revolution per minute

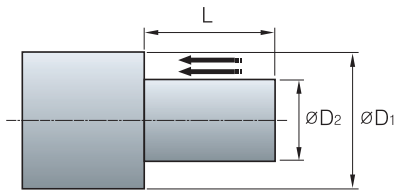
$$T = \frac{60 \times L}{fn \times n}$$

Constant cutting speed

$$T = \frac{60 \times \pi \times L \times D}{1000 \times fn \times vc}$$

T: Machining time [sec]
L: Cutting length [mm]
fn: Feed per revolution [mm/rev]
n: Revolution per minute [min⁻¹]
D: Diameter of workpiece [mm]
vc: Cutting speed [m/min]

External face machining 2



Constant revolution per minute

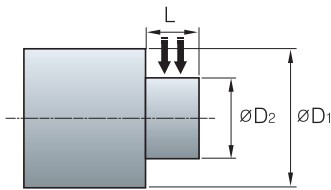
$$T = \frac{60 \times L}{fn \times n} \times N$$

Constant cutting speed

$$T = \frac{60 \times \pi \times L \times (D_1 + D_2)}{2 \times 1000 \times fn \times vc} \times N$$

T: Machining time [sec]
L: Cutting length [mm]
fn: Feed per revolution [mm/rev]
n: Revolution per minute [min⁻¹]
D1: Maximum diameter of workpiece [mm]
D2: Minimum diameter of workpiece [mm]
vc: Cutting speed [m/min]
N: The number of pass = (D1-D2)/d/2

Facing



Constant revolution per minute

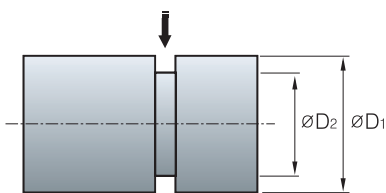
$$T = \frac{60 \times (D_1 - D_2)}{2 \times fn \times n} \times N$$

Constant cutting speed

$$T_1 = \frac{60 \times \pi \times (D_1 + D_2) \times (D_1 - D_2)}{4000 \times fn \times vc} \times N$$

T: Machining time [sec]
T1: Machining time before the maximum rpm[sec]
L: Width of machining [mm]
fn: Feed per revolution [mm/rev]
n: Revolution per minute [min⁻¹]
D1: Maximum diameter of workpiece [mm]
D2: Minimum diameter of workpiece [mm]
vc: Cutting speed [m/min]
N: The number of pass = (D1-D2)/d/2

Grooving



Constant revolution per minute

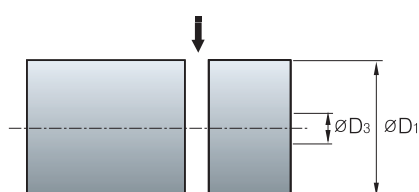
$$T = \frac{60 \times (D_1 - D_2)}{2 \times fn \times n}$$

Constant cutting speed

$$T_1 = \frac{60 \times \pi \times (D_1 + D_2) \times (D_1 - D_2)}{4000 \times fn \times vc}$$

T: Machining time [sec]
T1: Machining time before the maximum rpm[sec]
L: Width of machining [mm]
fn: Feed per revolution [mm/rev]
n: Revolution per minute [min⁻¹]
D1: Maximum diameter of workpiece [mm]
D2: Minimum diameter of workpiece [mm]
vc: Cutting speed [m/min]

Parting



Constant revolution per minute

$$T = \frac{60 \times D_1}{2 \times fn \times n}$$

Constant cutting speed

$$T_1 = \frac{60 \times \pi \times (D_1 + D_3) \times (D_1 - D_3)}{4000 \times fn \times vc}$$

$$T_3 = T_1 + \frac{60 \times D_3}{2 \times fn \times n_{max}}$$

T: Machining time [sec]
T1: Machining time before the maximum rpm[sec]
T3: Machining time till maximum RPM[sec]
fn: Feed per revolution [mm/rev]
n: Revolution per minute [min⁻¹]
nmax: Maximum revolution per minute [min⁻¹]
D1: Maximum diameter of workpiece [mm]
D3: Maximum diameter at maximum RPM [mm]
vc: Cutting speed [m/min]

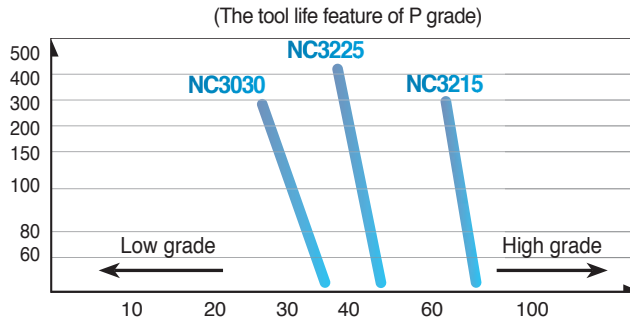
Technical Information for Turning

The affects of cutting condition

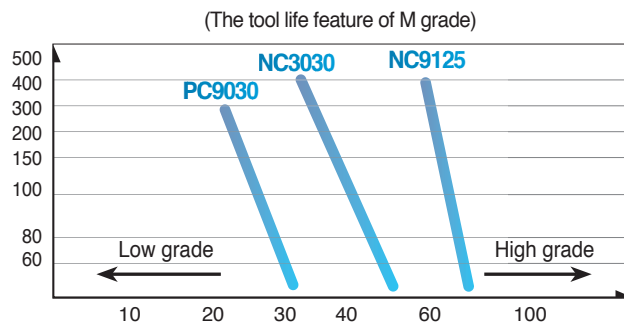
- The most desirable machining means short machining time, long tool life and good precision
This is the reason that proper cutting condition for each tools should be selected according to material's properties, hardness, shapes, the efficiency of machine

Cutting speed

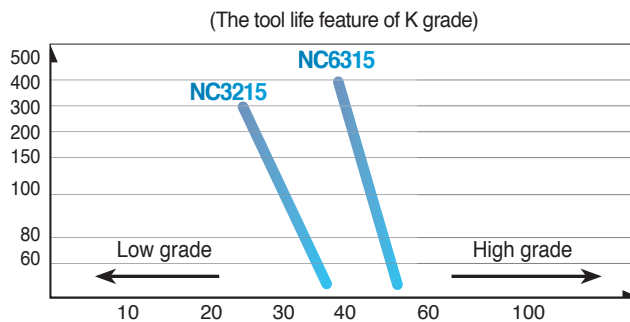
- **Workpiece:** S45C (180HB)
- **Tool life criterion:** VB = 0.2 mm
- **Depth of cut:** 1.5 mm
- **Feed:** 0.3 mm/rev
- **Holder:** PCLNR2525-M12
- **Insert:** CNMG120408, Dry cutting



- **Workpiece:** STS304 (200HB)
- **Tool life criterion:** VB = 0.2 mm
- **Depth of cut:** 1.5 mm
- **Feed:** 0.3 mm/rev
- **Holder:** PCLNR2525-M12
- **Insert:** CNMG120408, Dry cutting



- **Workpiece:** GC300 (180HB)
- **Tool life criterion:** VB = 0.2 mm
- **Depth of cut:** 1.5 mm
- **Feed:** 0.3 mm/rev
- **Holder:** PCLNR2525-M12
- **Insert:** CNMG120408, Dry cutting



Cutting Speed's effects

- When the cutting speed increases up to 20% in an application, the tool life respectively decreases down 50%
Although inversely, if the cutting speed increases up to 50% the tool life decreases 20%. On the other hand if cutting speed is too low (20-40m/min) Tool life shortens due to vibration



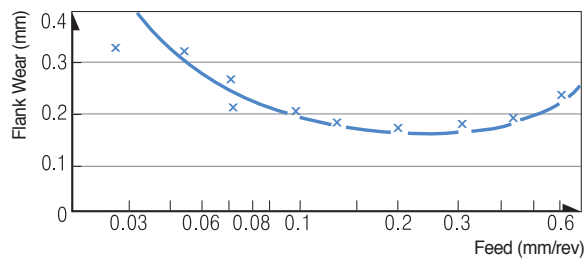
➤ Feed

- The feed rate in turning means the progressed interval of a distance in a work piece within 1 revolution
The feed rate in a milling application means the table feed divided by number of teeth of cutter (feed rate per tooth)

➤ The effects of feed

- When the feed rate decreases the flank wear is increased. When the feed rate is too low, the tool life shortens radically
- When the feed rate increases, the flank wear increases due to high temperatures, however the feed rates effects tool life less than the cutting speed. And higher feed rates improve machining efficiency

(Relationship between feed and flank wear in steel turning)

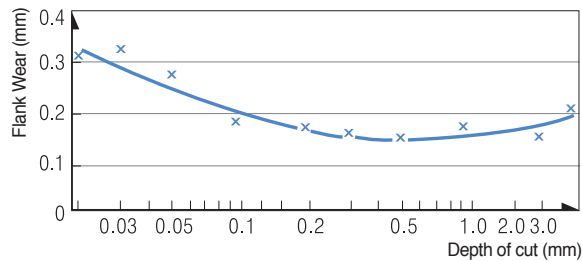


- **Workpiece:** SNCN431
- **Grade:** ST20
- **Cutting speed:** 200 m/min
- **Depth of cut:** 1.0 mm
- **Cutting time:** 10 min

➤ Depth of cut

- Determined by the required allowances in machining a material and the capacity the machine can tolerate
There are cutting limits according to the different shapes and sizes of the insert

(Relationship between depth of cut and flank wear in steel turning)

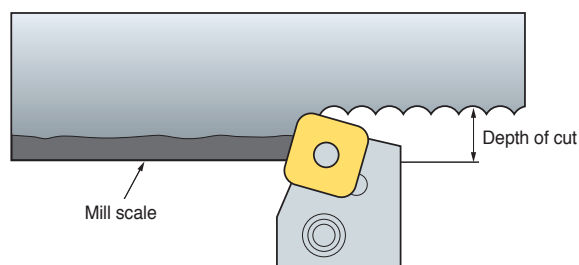


- **Workpiece:** SNCN431
- **Grade:** ST20
- **Cutting speed:** 200 m/min
- **Feed:** 0.2 mm/rev
- **Cutting time:** 10 min

➤ The effect of a depth of cut

- The depth of cut does not have a big influence on tool life
- When the depth of cut is small the work piece is not cut but rather rubbed. In these cases, machine off the work hardened parts that decrease tool life
- When machining a cast skin or milling scale smaller depth of cuts usually cause chipping and abnormal wear because of hard impurities in the surface of the work piece

(Surface parts including mill scale Roughing)



Technical Information for Turning

Relief angle

- Relief angle avoids the friction between workpiece and relief face and makes cutting edge move along workpiece easily

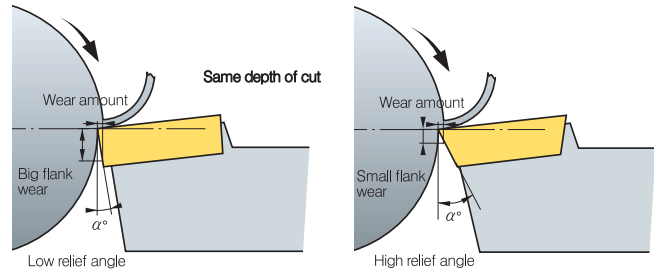
Relationship between various relief angle and flank wear

Affects

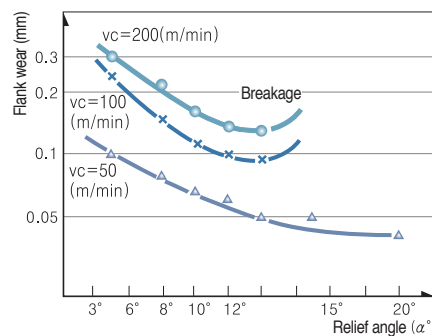
- If relief angle is big Flank wear decreases
- If relief angle is big Cutting edge strength weakens
- If relief angle is small Chattering occurs

Selection system

- Hard workpiece/When strong cutting edge is needed
 - Low relief angle
- Soft workpiece/Workpiece turning to work hardening easily
 - High relief angle



- Workpiece: SNCM431 (HB)
- Grade: P20
- Depth of cut: 1 mm
- Feed: 0.32 mm/rev
- Cutting time: 20 min



Side cutting edge angle

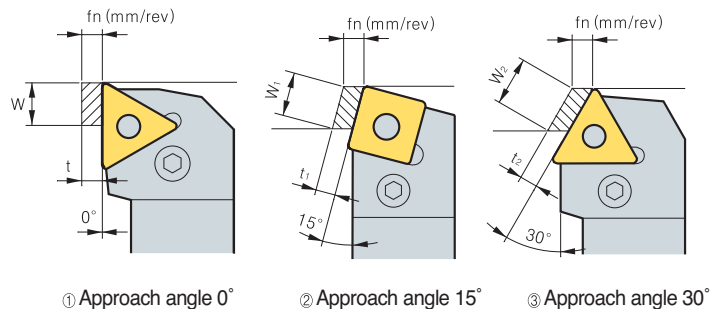
- Side cutting edge angle has big influence on chip flow and cutting force therefore proper Side cutting edge angle is very important

Side cutting edge angle and chip thickness

- As side cutting edge angle is getting bigger chips are getting thinner and wider (refer to left picture)
- At the same feed and depth of cut with approach angle 0° Chip thickness is the same as feed ($t = f_n$) and chip width is equal to depth of cut ($W = ap$)

$$t_1 = 0.97t, W_1 = 1.04W$$

$$t_2 = 0.87t, W_2 = 1.15W$$



Side cutting edge angle and 3 cutting forces

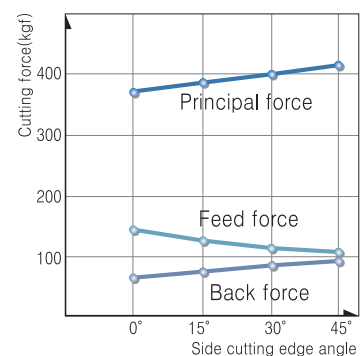
Affects

- Big side cutting edge angle with the same feed makes chip attaching length longer and chip thickness thinner. So that cutting forces scatter to long cutting edge therefore tool life gets longer
- Big side cutting edge angle for machining long bars can cause bending

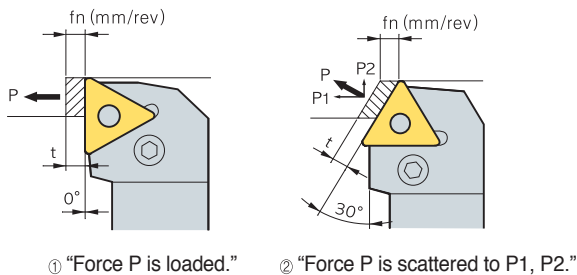
Selection system

- Deep depth of cut finishing/Long thin workpiece/Low machine rigidity
 - Side cutting edge angle
- Hard and high calorific power workpiece/Roughing big workpiece/High machine rigidity - Side cutting edge angle

- Workpiece : SCM440 (HB250)
- Grade: TNGA220412
- vc: 100 m/min
- ap: 4 mm
- fn: 0.45 mm/rev



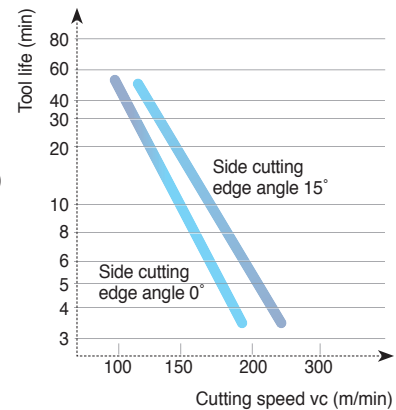
● Side cutting edge angle and cutting load



As approach angle gets bigger Back force gets bigger and feed force gets smaller

● Side cutting edge angle and tool life

- Workpiece: SCM440
- Grade: P20
- Depth of cut: 3 mm
- Feed: 0.2 mm/rev



● Side cutting edge angle and cutting performance

Specification	Low	← Approach angle →	High
Wear rate	High		Low
Workpiece	Easy to cut material		Difficult to cut material
Machining power	Small		Big
Chatter	Hard to occur		Easy to occur
How to machine	Finishing		Roughing
Workpiece rigidity	Long thin workpiece		Thick workpiece
Machine rigidity	In case of low rigidity		In case of high rigidity

🔍 End cutting edge angle

- It affects machined surface to prevent interference between surface of workpiece and insert

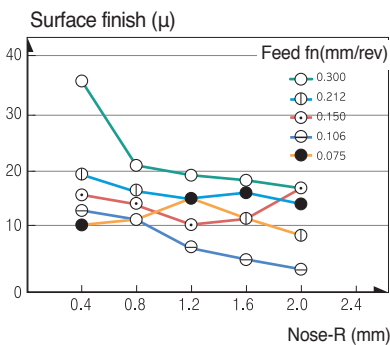
Affects

1. If end cutting edge angle reduces cutting edge get stronger but cutting heat generated by machining increases
2. Small end cutting edge angle can cause chattering due to the increases cutting force

🔍 Nose-R

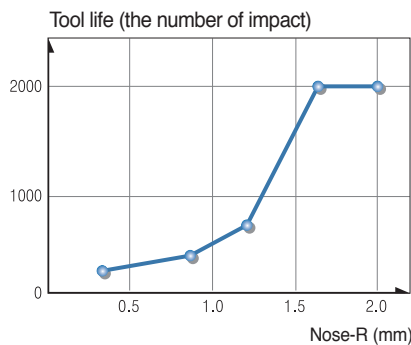
- Nose-R affects not only surface roughness but strength of cutting edge
- In general, It's desirable that Nose-R is 2~3 times bigger than feed

● Nose R and surface finish



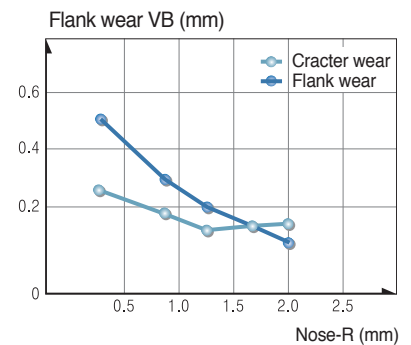
- Workpiece: SNCM439, HB200
- Grade: P20
- v_c : 120 m/min
- ap : 0.5 mm

● Nose R and tool life



- Workpiece: SCM440, HB280
- Grade: P10
- v_c : 100 m/min, ap : 0.5 mm
- fn : 0.3 mm/rev

● Nose R and wear of tool



- Workpiece: SNCM439, HB200
- Grade: P10
- v_c : 140 m/min, ap : 2 mm
- fn : 0.2 mm/rev, T : 10 min

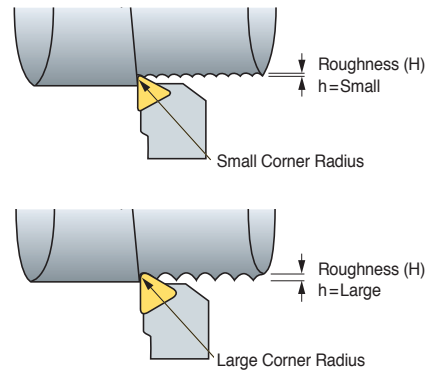
Nose-R

Affects

1. Big Nose-R improves surface finish
2. Big Nose-R improves cutting edge strength
3. Big Nose-R reduces flank wear and crater wear
4. Too big Nose-R causes chattering due to increased cutting force

Selection system

1. For finishing with small depth of cut/long and thin workpiece/
When machine power is low - Small Nose-R
2. For applications that need strong cutting edge such as intermittent
and machining mill scale/For roughing of big workpiece/When
the machine power is strong enough - Big Nose-R



Relationship between nose radius, feed and various surface roughness

Nose R \ Feed (mm/rev)	0.4	0.8	1.2
0.15			
0.26			
0.46			

Cutting edge shape and the affects

Rake angle (α)

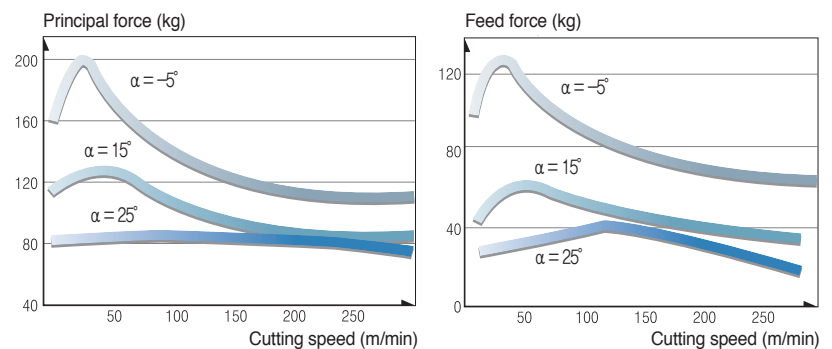
Rake angle has big influence on cutting force, chip flow and tool life

Affects

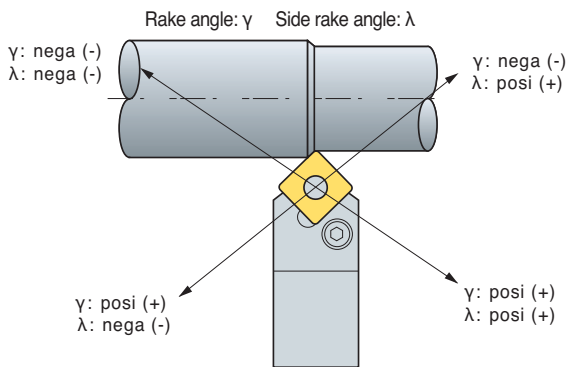
1. High rake angle results in good surface finish
2. As the rake angle increases by 1° Machining power decreases by 1%.
3. High rake angle weakens cutting edge

Selection system

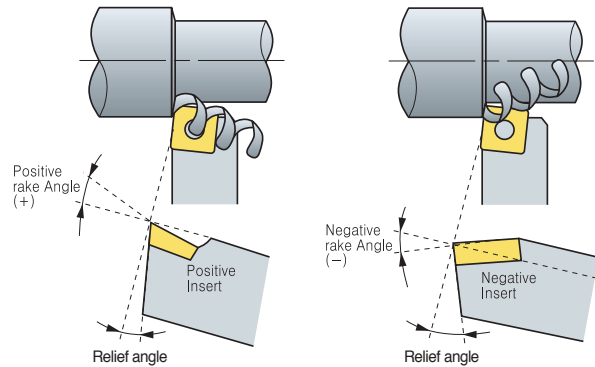
1. For hard workpiece/For applications that need strong cutting edge such as interrupted and machining mill scale - Low rake angle
2. For soft workpiece/Easy to cut material/When the rigidity of machine power and workpiece is low - High rake angle



● Rake angle and the direction of chip flow



In order to prevent machined surface from damages Avoid nega, posi combination. γ : nega (-) λ : posi (+)



➤ Selecting proper tools

- Nowadays, It's very difficult to select the best tools in complicating tooling system and various cutting conditions
- However, It can be simplified by classifying basic factors below

● Selection of inserts and tool holder

Listed below is the basic factors and choose B according to A

A : Basic factors

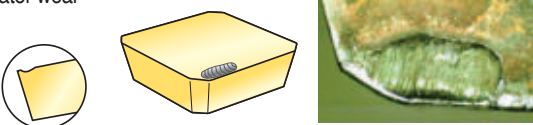
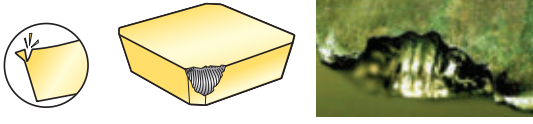
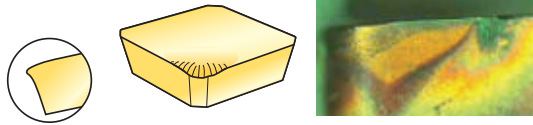






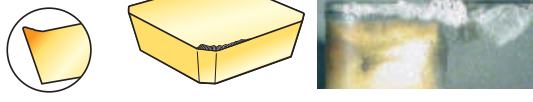
- Workpiece material
- Workpiece shape
- Workpiece size
- Hardness of workpiece
- Surface roughness of workpiece (before machining)
- Surface finish required
- Type of lathe machine
- Condition of lathe machine (rigidity, power etc)
- Horse power of machine
- Clamping method of workpiece

B : Selection system

- ① Select as big approach angle as possible
- ② Select as big shank as possible
- ③ Select as strong cutting edge of insert as possible
- ④ Select as big nose radius as possible
- ⑤ In finishing, Select the insert using many corners
- ⑥ Select as small insert as possible
- ⑦ Cutting speed should be determined carefully according to cutting conditions
- ⑧ Select as deep depth of cut as possible
- ⑨ Select as fast feed as possible
- ⑩ Cutting condition should be determined within chip breaker application ranges



Trouble shooting

Tool failure	Cause	Solution
<p>Crater wear</p> 	<ul style="list-style-type: none"> • Improper grade • Excessive cutting condition 	<ul style="list-style-type: none"> • Choose harder grade • Decrease cutting condition
<p>Fracture</p> 	<ul style="list-style-type: none"> • Improper grade • Excessive feed • Shorten cutting edge strength • Insufficient rigidity of holder 	<ul style="list-style-type: none"> • Choose tougher grade • Decrease feed • Apply to large honed or chamfered edge • Choose bigger size holder
<p>Plastic deformation</p> 	<ul style="list-style-type: none"> • Improper grade • Excessive cutting condition • High cutting temperature 	<ul style="list-style-type: none"> • Choose harder grade • Decrease cutting condition • Choose grade with heat conductivity are big
<p>Wear on nose radius (Flank wear)</p> 	<ul style="list-style-type: none"> • When the hardness of workpiece is too high compare with tool • When machining surface hardened workpiece • Improper grade • Excessive cutting speed • Too small relief angle • Too low feed 	<ul style="list-style-type: none"> • Choose harder grade • Decrease cutting speed • Choose larger relief angle • Increase feed
<p>Thermal crack</p> 	<ul style="list-style-type: none"> • Expansion and shrinking by cutting temperature • Improper grade (*Specially milling operation) 	<ul style="list-style-type: none"> • Apply to dry cutting (In case of wet cutting, use enough coolant) • Choose tougher grade
<p>Chipping</p> 	<ul style="list-style-type: none"> • Improper grade • Excessive feed • Shorten cutting edge strength • Insufficient rigidity of holder 	<ul style="list-style-type: none"> • Choose tougher grade • Decrease feed • Apply to large honing or chamfer edge • Choose bigger size holder
<p>Notch wear</p> 	<ul style="list-style-type: none"> • Surface hardened workpiece • Friction due to bad chip geometry (Generate vibration) 	<ul style="list-style-type: none"> • Choose harder grade • Improve chip control form large rake angle
<p>Flaking</p> 	<ul style="list-style-type: none"> • Deposition on cutting edge • Bad chip control 	<ul style="list-style-type: none"> • Improve cutting performance from large rake angle • Apply to chip pocket with big size
<p>Complete breakage</p> 	<ul style="list-style-type: none"> • Unusable condition due to wear off the most parts of cutting edge by progress of wear 	<ul style="list-style-type: none"> • Reduce the feed rate. • Reduce the depth of cut. • Select a tougher grade. • Select a stronger chipbreaker. • Select a thicker insert.
<p>Built-up edge</p> 	<ul style="list-style-type: none"> • Slow cutting speed • Sticky materials 	<ul style="list-style-type: none"> • Increase cutting speed. • Use more positive rake geometry. • Use tougher grade

Types of tool failure and trouble shooting

Troubles	Causes	Solution																
		Cutting conditions				Selecting insert grade				Tool shape				Machine clamping				
		Cutting speed	Feed	Depth of cut	Coolant	Select harder grade	Select tougher grade	Select better heat-impact resistance grade	Select better adhesion resistance grade	Chip breaker valuation	Flake angle	Nose radius	Side cutting edge angle	Cutting edge strength Honing	Improving insert precision M class → G class	Improving holder rigidity	Clamping workpiece	Holder overhang
Poor precision Unstable machining size	Insert precision is variable													●				
	Workpiece, Separation of tool								●	↑	↓				●	●	●	●
Cutting edge back thrust is big It's necessary to adjust because machining precision changes during operation.	Flank wear increase					●					↑							
	Cutting condition is improper	↓	↑			●												
Poor surface roughness for finishing Criterion of tool life.	Weakened cutting force by increasing wear of tool	↓			Wet cutting			●	●	↑	↑		↓	●				
	Cutting edge chipping		↓	↓		●			●		↑		↑			●	●	●
	Adhesion, built-up edge	↑	↑		Wet cutting			●	●	↑			↓	●				
	Improper cutting conditions	↑	↓	↓	Wet cutting													
	Improper tool and shape of cutting edge								●		↑		↓	●				
	Vibration, chattering	↓	↓	↓	Wet cutting	●			●	●	↑	↓		↓		●	●	●
Cutting heat generation Poor machining precision and short tool life by cutting heat	Improper cutting conditions	↓	↓	↓		●												
	Improper tool and shape of cutting edge								●	↑			↓					
Burr, chipping, nap steel, aluminum (burr)	Improper cutting conditions	↓	↑		Wet cutting	●												
	Wear on the tool, improper shape of cutting edge							⊙	●	↑	↓		↓					
Cast iron (Weak chipping)	Improper cutting conditions		↓	↓		●												
	Wear on the tool, improper shape of cutting edge								●	↑	↑		↓		●	●	●	●
Soft steel (nap)	Improper cutting conditions	↑	↑		Wet cutting	●												
	Wear on the tool, improper shape of cutting edge							⊙	●	↑			↓					

↑: Increase ↓: Decrease ●: use ⊙: Correct use

Tool life criterion

● KS B0813

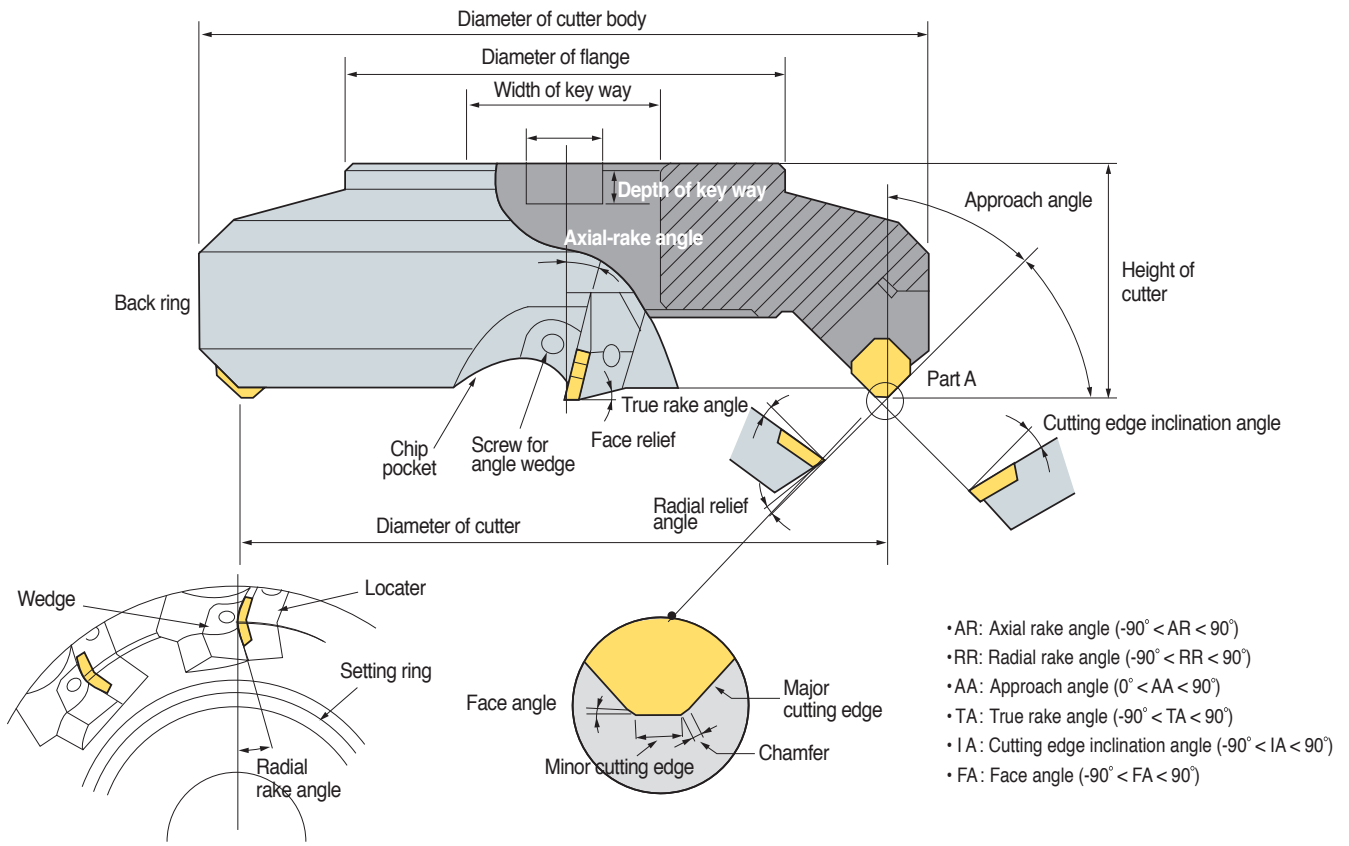
Flank wear width	Value	Application
	0.2 mm	Precision light cutting, Finishing in nonferrous alloy
	0.4 mm	Machining special steel
	0.7 mm	General cutting in cast iron, steel etc
	1~1.25 mm	General cutting in cast iron, steel etc
Depth of crater wear	In general 0.05~0.1 mm	

● ISO (B8688)

Tool life criterion	Application
Complete breakage	Machining special steel
Flank wear width VB = 0.3 mm	Even flank wear of cemented carbides, Ceramic tool
VBmax = 0.5 mm	Uneven flank wear
Crater wear width KT = 0.06+0.3fmm (f:mm/rev)	Cemented carbides tool
Criterion by surface roughness 1, 1.6, 2.5, 4, 6.3, 10μRa	When surface roughness is important



Milling cutter shape and designation



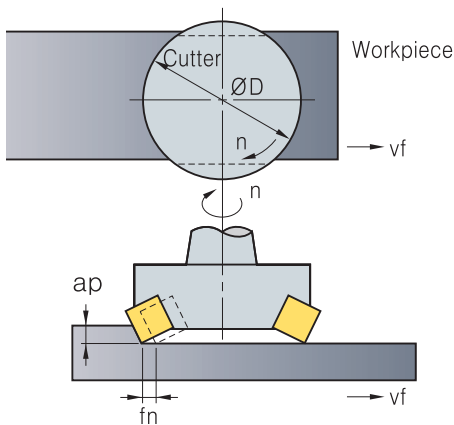
The terminology and functions of cutting edge angle

No.	Tool failure	Symbol	Function	Effects
1	Axial rake angle	A.R	Chip flow direction, Adhesion	Positive: Excellent cutting, built-up edge prevented
2	Radial rake angle	R.R	Affecting on thrust	Negative: Excellent chip control
3	Approach angle	A.A	Chip thickness, Determines flow direction	(+): Chip thickness become thinner, cutting force could be reduced
4	True rake angle	T.A	Effective rake angle	(+): Better cutting. Preventing adhesion, Weakening cutting edge strength (-): Cutting edge strength increases, easy to adhere
5	Cutting edge inclination angle	I.A	Determines chip flow direction	(+): Good chip flow, cutting force could decrease, Corner edge strength weakens
6	Relief angle	F.A	Controlling cutting edge strength, tool life and chattering	Surface roughness increases as F.A gets close to 0 degree

Features by combination of rake angle

	Double positive angle	Double negative angle	Posi - Negative angle	Nega - Positive angle
Division				
Use	<ul style="list-style-type: none"> • General machining of steel, cast iron, stainless steel • Machining soft steel that brings about built-up edge easily • Machining material having tendency to poor surface roughness 	<ul style="list-style-type: none"> • Under interrupted cutting condition • Roughing of cast iron and steel 	<ul style="list-style-type: none"> • Machining difficult to cut material • Roughing with deep depth of cut and wide width of cut in steel and cast iron 	<ul style="list-style-type: none"> • Chip flows to center of cutter body
Advantages	<ul style="list-style-type: none"> • As for tough workpiece material It prevents built-up edge to improve surface roughness • Low cutting load and better machinability 	<ul style="list-style-type: none"> • Strong cutting edge • Roughing of workpiece that has bad surface condition containing sand, mill scale • Double sided inserts can be applied(Economical) • Good chip control 	<ul style="list-style-type: none"> • Good chip flow and machinability. • Suitable for machining of difficult-to-cut material 	-
Disadvantages	<ul style="list-style-type: none"> • Weak cutting edge strength • Only single sided inserts are available (No economical) • Machine and cutter need enough power and rigidity 	<ul style="list-style-type: none"> • Machine and cutter need enough power and rigidity 	<ul style="list-style-type: none"> • Only single sided inserts are available (No economical) 	<ul style="list-style-type: none"> • Since the chips flows toward the center of cutter. Chips scratch on machined surface • Bad chip flow • No economical

Major cutting formulas



● Cutting speed

$$vc = \frac{\pi \cdot D \cdot n}{1000} \text{ (m/min)}$$

- vc: Cutting speed (m/min)
- D: Diameter of tool (mm)
- n: Revolution per minute (min⁻¹)
- π: Circular constant (3.14)

● Feed

$$fz = \frac{vf}{z \cdot n} \text{ (mm/t)}$$

- fz: Feed per tooth (mm/t)
- vf: Feed per minute (mm/min)
- n: Revolution per minute (min⁻¹)
- z: Number of tooth

● Chip removal amount

$$Q = \frac{L \cdot v_f \cdot a_p}{1000} \text{ (cm}^3\text{/min)}$$

- Q: Chip removal amount (cm³/min)
- L: Width of cut (mm)
- vf: Table feed (mm/min)
- ap: Depth of cut (mm)

● Power requirement

$$P_{kw} = \frac{Q \cdot k_c}{60 \times 10^2 \times \eta} \quad P_{hp} = \frac{P_{kw}}{0.75}$$

- Pc: Power requirement (kW)
- H: Horse power requirement (hp) (mm/min)
- Q: Chip removal amount (cm³/min)
- kc: Specific cutting resistance (kgf/mm³)
- η: Machine efficiency rate (0.7~0.8)

● Machining time

$$T = \frac{60 \times Lt}{vf} \text{ (sec)}$$

- T: Machining time (sec)
- Lt: Total length of table feed (mm) (= Lw+D+2R)
- Lw: The length of workpiece (mm)
- D: The diameter of cutter body (mm)
- vf: Table feed (mm/min)
- R: Relief length (mm)

● True rake angle/Cutting edge inclination angle

True rake angle $\tan(T) = \tan(R) \times \cos(AA) + \tan(A) \times \sin(C)$
 Cutting edge inclination angle $\tan(I) = \tan(A) \times \cos(AA) - \tan(R) \times \sin(C)$



Technical Information for Milling

Values of specific cutting resistance

Workpiece	Tensile strength (kg/mm ²) and hardness	Specific cutting resistance according to various feed kc(MPa)				
		0.1 (mm/t)	0.2 (mm/t)	0.3 (mm/t)	0.4 (mm/t)	0.6 (mm/t)
Soft steel	52	220	195	182	170	158
Medium carbon steel	62	198	180	173	160	157
High carbon steel	72	252	220	204	185	174
Tool steel	67	198	180	173	170	160
Tool steel	77	203	180	175	170	158
Chrome manganese steel	77	230	200	188	175	166
Chrome manganese steel	63	275	230	206	180	178
Chrome molybdenum steel	73	254	225	214	200	180
Chrome molybdenum steel	60	218	200	186	180	167
Nickel Chrome molybdenum steel	94	200	180	168	160	150
Nickel Chrome molybdenum steel	HB352	210	190	176	170	153
Cast steel	52	280	250	232	220	204
Hardened cast iron	Hrc46	300	270	250	240	220
Meehanite cast iron	36	218	200	175	160	147
Gray cast iron	HB200	175	140	124	105	97
Brass	50	115	95	80	70	63
Light alloy (Al - Mg)	16	58	48	40	35	32
Light alloy (Al - Si)	20	70	60	52	45	39

Chip removal amount (cm³/min) per rated horse power

Workpiece	Rated horse power	Chip removal amount (cm ³ /min)					
		5Hp	10Hp	20Hp	30Hp	40Hp	50Hp
Steel	Soft	32	75	163	295	425	570
	Medium	26	55	127	212	310	425
	hard	18	41	93	163	228	310
Cast iron	Soft	52	116	260	455	670	880
	Medium	32	75	163	295	425	570
	hard	26	55	127	212	310	425
Bronze Brass	Soft	77	163	390	670	980	1,280
	Medium	54	118	275	490	700	910
	hard	26	55	127	245	325	425
Aluminum		90	195	440	780	1,110	1,500

Classification of surface roughness

Type	Symbol	How to calculate	Measured value
Maximum height	Rmax	<ul style="list-style-type: none"> The distance between the top of profile peak line and the bottom of profile valley line on this sampled portion is measured in the longitudinal magnification direction of roughness curve (Expressed by unit: μ) Exclude extraordinary values (too small or big) that look like grooves or mountains 	
+10 point mean roughness	Rz	<ul style="list-style-type: none"> Sampled from the roughness curve in the direction of its mean line, the sum of the average value of absolute value of the highest profile peaks and the depths of five deepest profile valleys measured in the vertical magnification is expressed by micro meter (μ) 	
Arithmetic mean roughness	Ra	<ul style="list-style-type: none"> Sampling only the reference length from the roughness curve in the direction of mean line , taking X-axis in the direction of mean line and Y-axis in the direction of longitudinal magnification of this sampled part and is expressed by micro meter (μ) Generally, Read measured value by Ra measurer 	

Finish mark		▽▽▽▽	▽▽▽	▽▽	▽	~
Surface roughness	Rmax	0.8s	6.3s	25s	100s	Unspecified
	Rz	0.8z	6.3z	25z	100z	
	Ra	0.2a	1.6a	6.3a	25a	

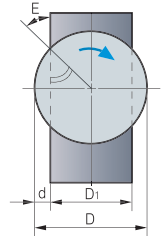
Selection of MILL-MAX diameter (D)

Selection by machine rigidity

Machine horse power (PS)	10~15	15~20	Over 20
Proper cutter body specification (mm)	Ø80~Ø100	Ø125~Ø160	Ø160~Ø200

Selection by machine rigidity

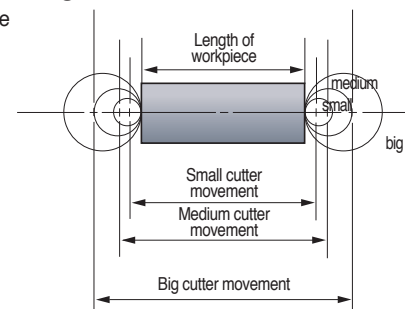
Workpiece	E	δ
Steel	+20°~10°	3 : 2
Cast iron	Under +50°	5 : 4
Light alloy	Under +40°	5 : 3



D: External diameter of cutter body
 D1: Width of workpiece
 d: Projected part of cutter body
 E: Engage angle
 δ: Ratio of cutter body and width of workpiece (D: D1)

Selection by machining time

The bigger size cutter the longer machining time



Selection by number of tooth

Workpiece	Steel	Cast iron	Light alloy
Number of tooth	Dx (1~1.5)	Dx (1~4)	Dx1+α

ex) D = ø100 ⇒ 4" x(1~1.5) = 4~6 D is the size of cutter body converted into inch size



🔍 Trouble shooting for milling

Trouble	Causes	Solutions										
		Cutting conditions				Tool shape					Insert grade	
		Cutting speed	Depth of cut	Feed	Coolant	Rake angle	Relief angle	Approach angle	Chattering at cutting edge	Nose radius	Toughness	Hardness
Flank wear	<ul style="list-style-type: none"> • Improper insert grade • Improper cutting conditions • Chattering 	↓		↑			↑	↓		↑		↑
Crater wear	<ul style="list-style-type: none"> • Improper cutting conditions • Improper insert grade 	↓	↓	↓	●	↑	↑			↓		↑
Chipping	<ul style="list-style-type: none"> • Lack of insert toughness • Excessive feed • Excessive cutting load 			↓		↓	↓	↓		↑	↑	
Built-up edge	<ul style="list-style-type: none"> • Improper cutting conditions • Improper cutting edge shape • Improper insert grade 	↑	↓			↑				↓		
Chattering	<ul style="list-style-type: none"> • Improper cutting conditions • Lack of number of cutting teeth • Improper cutting edge shape • Bad chip flow • Unstable workpiece clamping 		↓	↓	●	↑		↑	↓	↓		
Poor surface finish	<ul style="list-style-type: none"> • Built-up edge • Improper cutting conditions • Chattering • Bad chip flow 	↑	↓	↓	●	↑			↓	↑		
Thermal crack	<ul style="list-style-type: none"> • Improper cutting conditions • Improper insert grade 	↓	↓	↓	⊙	↑				↑	↑	
Fracture	<ul style="list-style-type: none"> • Improper insert grade • Excessive cutting load • Bad chip flow • Chattering • Excessive overhang 		↓	↓	●							↑

↑: Increase ↓: Decrease ●: use ⊙: Correct use

🔍 General formulas for milling

● Machine efficiency rate (η)

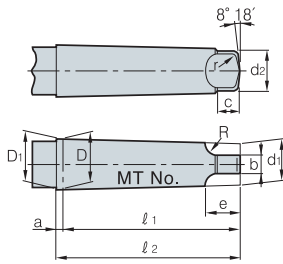
Power transmission mode	Efficiency rate (E)	Reference
Principal axis direct connection driving	0.90	
Belt driving	0.85	Double connection: $0.85 \times 0.85 \approx 0.70$
Starting driving	0.75	
Oil pressure driving	0.60~0.90	



Technical Information for Tapers

(mm)

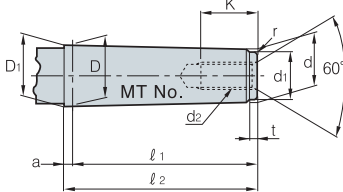
Morse taper (Tang type)



MTNo.	Taper	Taper angle (α)	D	a	D ₁	d ₁	ℓ ₁	ℓ ₂	d ₂	b	c	e	R	r
0	$\frac{1}{19.212}$	1°29'27"	9.045	3	9.201	6.104	56.5	59.5	6.0	3.9	6.5	10.5	4	1
1	$\frac{1}{20.047}$	1°25'43"	12.065	3.5	12.240	8.972	62.0	65.5	8.7	5.2	8.5	13.5	5	1.2
2	$\frac{1}{20.020}$	1°25'50"	17.780	5	18.030	14.034	75.0	80.0	13.5	6.3	10	16	6	1.6
3	$\frac{1}{19.922}$	1°26'16"	23.825	5	24.076	19.107	94.0	99.0	18.5	7.9	13	20	7	2
4	$\frac{1}{19.254}$	1°29'15"	31.267	6.5	31.605	25.164	117.5	124.0	24.5	11.9	16	24	8	2.5
5	$\frac{1}{19.002}$	1°30'26"	44.399	6.5	4.741	36.531	149.5	156.0	35.7	15.9	19	29	10	3
6	$\frac{1}{19.180}$	1°29'36"	63.348	8	63.765	52.399	210.0	218.0	51.0	19.0	27	40	13	4
7	$\frac{1}{19.231}$	1°29'22"	83.058	10	83.578	68.186	286.0	296.0	66.8	28.6	35	54	19	5

(mm)

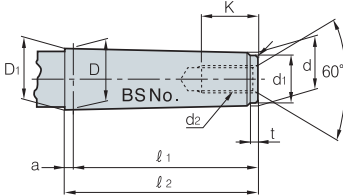
Morse taper (Screw type)



MTNo.	Taper	Taper angle (α)	D	a	D ₁	d	ℓ ₁	ℓ ₂	d ₁	d ₂	k	t	r
0	$\frac{1}{19.212}$	1°29'27"	9.045	3	9.201	6.442	50	53	6	-	-	4	0.2
1	$\frac{1}{20.047}$	1°25'43"	12.065	3.5	12.230	9.396	53.5	57	9	M6	16	5	0.2
2	$\frac{1}{20.020}$	1°25'50"	17.780	5	18.030	14.583	64	69	14	M10	24	5	0.2
3	$\frac{1}{19.922}$	1°26'16"	23.825	5	24.076	19.759	81	86	19	M12	28	7	0.6
4	$\frac{1}{19.254}$	1°29'15"	31.267	6.5	31.605	25.943	102.5	109	25	M16	32	9	1
5	$\frac{1}{19.002}$	1°30'26"	44.399	6.5	4.741	37.584	129.5	136	35.7	M20	40	9	2.5
6	$\frac{1}{19.180}$	1°29'36"	63.348	8	63.765	53.859	182	190	51	M24	50	12	4
7	$\frac{1}{19.231}$	1°29'22"	83.058	10	83.578	70.058	250	260	65	M33	80	18.5	5

(mm)

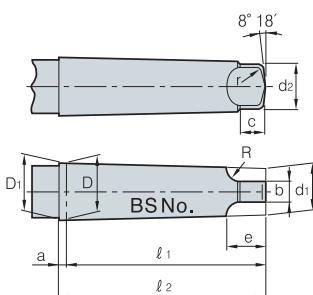
Brown sharp taper (Screw type)



B&S No.	D	a	D ₁	d	d ₁	ℓ ₁	ℓ ₂	t	r	d ₂	K
4	10.221	2.4	10.321	8.890	8.0	31.0	34.2	2	0.2	-	-
5	13.286	2.4	13.386	11.430	10.0	44.4	46.8	3	0.2	-	-
6	15.229	2.4	15.330	12.700	11.0	60.0	62.7	3	0.2	M 8(1/4)	20
7	18.424	2.4	18.524	15.240	14.0	76.2	78.6	4	0.2	M10(3/8)	24
8	22.828	3.2	22.962	19.090	17.0	90.5	93.7	4	0.6	M12(1/2)	28
9	27.104	3.2	27.238	22.863	21.0	101.6	104.8	4	0.6	M12(1/2)	28
10	32.749	3.2	32.887	26.534	24.0	144.5	147.7	5	1.0	M16(5/8)	32
11	38.905	3.2	39.039	31.749	29.0	171.4	174.6	5	1.0	M16(5/8)	32
12	45.641	3.2	45.774	38.103	35.0	181.0	184.2	6	2.5	M20(3/4)	40
13	52.654	3.2	52.787	44.451	41.0	196.8	200.0	6	3.0	M20(3/4)	40
14	59.533	3.2	59.666	50.800	47.0	209.6	212.8	7	4.0	M24(1)	40
15	66.408	3.2	66.541	57.150	53.0	222.2	225.4	7	4.0	M24(1)	50
16	73.292	3.2	73.425	63.500	59.0	35.0	238.2	8	5.0	M30(1 1/8)	60

(mm)

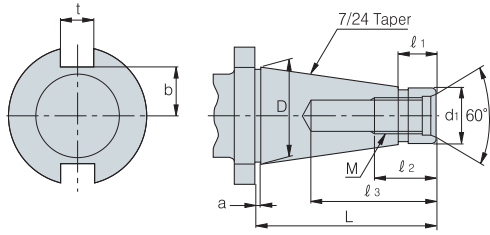
Brown sharp taper (Tang type)



B&S No.	D	a	D ₁	d ₁	d ₂	ℓ ₁	ℓ ₂	b	c	e	R	r
4	10.221	2.4	10.321	8.458	8.1	42.1	44.5	5.5	8.7	14.4	7.9	1.3
5	13.286	2.4	13.386	10.962	10.7	55.6	58.0	6.3	9.5	16.2	7.9	1.5
6	15.229	2.4	15.330	12.167	11.7	73.0	75.4	7.1	11.1	18.0	7.9	1.5
7	18.424	2.4	18.524	14.675	14.2	89.7	92.1	7.9	11.9	20.3	9.5	1.8
8	22.828	3.2	22.962	18.453	18.0	104.8	108.0	8.7	12.7	22.0	9.5	2.0
9	28.104	3.2	27.238	22.200	21.8	117.5	120.7	9.5	14.3	25.4	11.1	2.5
10	32.749	3.2	32.887	25.751	25.7	162.7	165.9	11.1	16.7	28.1	11.1	2.8
11	38.905	3.2	39.039	30.985	30.7	189.7	192.9	11.1	16.7	30.0	12.7	3.3
12	45.641	3.2	45.774	37.246	37.1	201.6	204.8	12.7	19.0	32.5	12.7	3.8
13	52.654	3.2	52.787	43.589	43.4	217.5	220.7	12.7	19.0	35.7	15.9	4.3
14	59.533	3.2	59.666	49.841	49.8	232.6	235.8	14.2	21.4	41.2	19.0	4.8
15	66.408	3.2	66.541	56.186	56.1	245.3	248.5	14.2	21.4	44.4	22.2	5.3
16	73.292	3.2	73.425	62.441	62.2	260.4	263.6	15.8	23.8	50.0	25.4	5.8

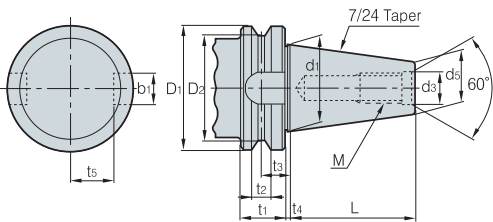


Standard taper of american milling machine



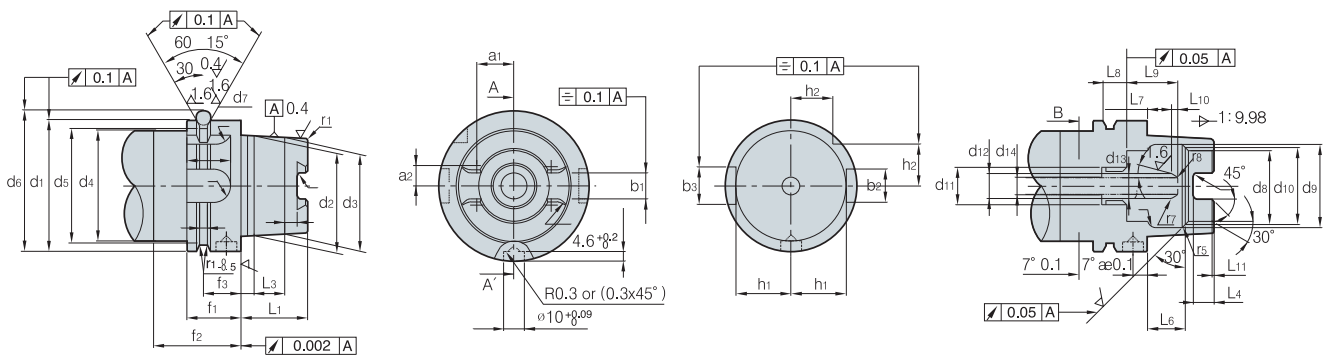
NT No.	Dimensions	D	D ₁	L	l ₁	M	l ₂	l ₃	a	t	b
30	1 ¹ / ₄	31.750	17.40 ^{-0.29} _{-0.36}	70	20	UNC 1/2"	24	50	1.6	15.9	6
40	1 ³ / ₄	44.450	25.32 ^{-0.30} _{-0.384}	95	25	UNC 5/8"	30	60	1.6	15.9	22.5
50	2 ³ / ₄	69.850	39.60 ^{-0.31} _{-0.41}	130	25	UNC 1"	45	90	3.2	25.4	35
60	4 ¹ / ₄	107.950	60.20 ^{-0.34} _{-0.46}	210	45	UNC 1 1/4"	56	110	3.2	25.4	60

Bottle grip taper



BT No.	D ₁	D ₂	t ₁	t ₂	t ₃	t ₄	d ₁	d ₃	L	M	b ₁	t _s	d ₅
35	53	43	22	10	14.6	2	38.1	13	56.5	M12×1.75	16.1	19.6	21.62
40	63	52	25	10	16.6	2	44.45	17	65.4	M16×2	16.1	22.6	25.3
45	85	73	30	12	21.2	3	57.15	21	82.8	M20×25	19.3	29.1	33.1
50	100	85	35	15	23.2	3	69.85	25	101.8	M24×3	25.7	35.4	40.1
60	155	135	45	20	28.2	3	107.95	31	161.8	M30×3.5	25.7	60.1	60.7

HSK shank (DIN 69893)



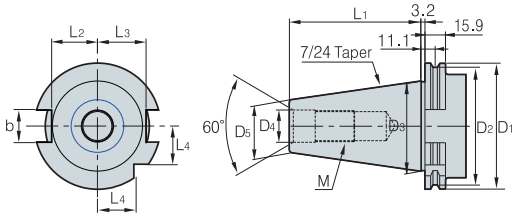
HSK No.	b ₁	b ₂	b ₃	d ₁	d ₂	d ₃	d ₄	d ₅	d ₆	d ₇	d ₈	d ₉	d ₁₀	d ₁₁	d ₁₂	d ₁₃	d ₁₄	a ₁	a ₂
50	10.54	12	14	50	38	36.90	42	43	59.3	7	26	32	29	M16X1	10	6.8	6.8	13.997	7.648
63	12.5	16	14	63	48	46.53	53	55	72.3	7	34	40	37	M18X1	12	8	8.4	17.862	9.25
100	20	20	14	100	75	72.80	85	92	109.75	7	53	63	58	M24X1.5	16	12	12	27.329	15.00

HSK No.	f ₁	f ₂	f ₃	f ₄	b ₁	b ₂	L ₁	L ₂	L ₃	L ₄	L ₅	L ₆	L ₇	L ₈	L ₉	L ₁₀	L ₁₁	L ₁₂	r ₁	r ₂	r ₃	r ₄	r ₅	r ₆	r ₇	r ₈
50	26	42	18	3.75	2	15.5	25	5	11	7.5	4.5	14.13	10	10	23	3	1	19	1	1.5	2.38	6	0.5	1	2	6
63	26	42	18	3.75	28.5	20	32	6.3	14.7	10	6	18.13	10	12	24.5	3	1	21	1.2	1.5	3	8	0.6	1.5	3	8
100	29	45	20	3.75	44	31.5	50	10	24	15	10	28.56	12.5	16	28	3	1.5	24	2	2	3	12	1	1.5	3	10

Technical Information for Tapers

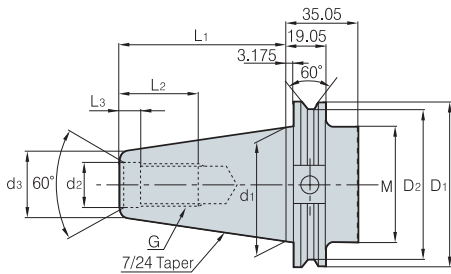
(mm)

DIN 69871



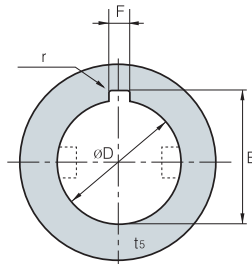
Shank No	D ₁	D ₂	D ₃	D ₄	D ₅	L ₁	L ₂	L ₃	L	b	M
30	50.0	44.3	31.75	13	17.8	47.8	16.4	19.0	33.5	16.0	M12x1.75
40	63.5	56.2	44.45	17	24.5	68.4	22.8	25.0	42.5	16.1	M16x2
45	82.5	57.2	57.15	21	33.0	82.7	29.1	31.3	52.5	19.3	M20x2.5
50	97.5	91.2	68.85	25	40.1	101.7	35.5	37.7	61.5	25.7	M24x3

CAT shank



Shank No	D ₁	D ₂	M	d ₁	d ₂	d ₃	L ₁	L ₂	L ₃	G
CAT40	63.5	56.36	M16x2	44.45	16.28	21.84	68.25	28.45	4.78	5/8-11
CAT45	82.55	75.41	M20x2.5	57.15	19.46	27.69	82.55	38.1	4.78	3/4-10
CAT50	98.43	91.29	M24x3	69.85	26.19	35.05	101.6	44.45	6.35	1-8

Standard of milling cutter hole (KSB3203)



● Type A

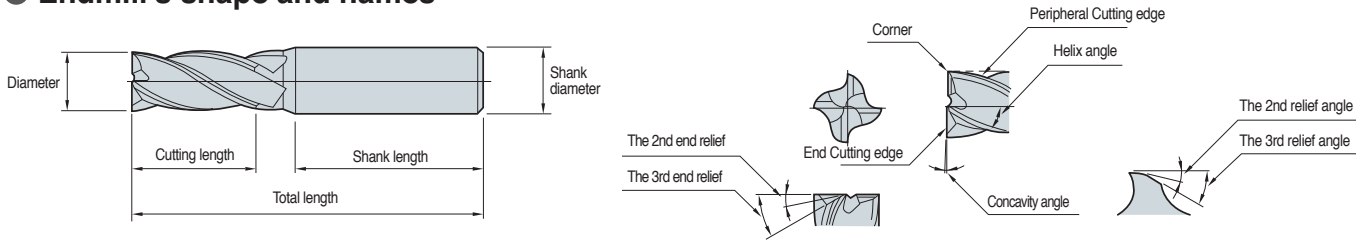
Diameter	øDH ₇	E	F	r
8	8 ^{+0.015} ₀	8.9 ^{+0.25} ₀	2 ^{+0.16} _{+0.06}	0.4
10	10 ^{+0.015} ₀	11.5 ^{+0.25} ₀	3 ^{+0.16} _{+0.06}	0.4
13	13 ^{+0.018} ₀	14.6 ^{+0.25} ₀	3 ^{+0.16} _{+0.06}	0.6
16	16 ^{+0.018} ₀	17.7 ^{+0.25} ₀	4 ^{+0.19} _{+0.07}	0.6
19	19 ^{+0.021} ₀	21.1 ^{+0.25} ₀	5 ^{+0.19} _{+0.07}	1
22	22 ^{+0.021} ₀	24.1 ^{+0.25} ₀	6 ^{+0.19} _{+0.07}	1
27	27 ^{+0.021} ₀	29.8 ^{+0.25} ₀	7 ^{+0.23} _{+0.08}	1.2
32	32 ^{+0.025} ₀	34.8 ^{+0.25} ₀	8 ^{+0.23} _{+0.08}	1.2
40	40 ^{+0.025} ₀	43.5 ^{+0.3} ₀	10 ^{+0.23} _{+0.08}	1.2
50	50 ^{+0.025} ₀	53.5 ^{+0.3} ₀	12 ^{+0.23} _{+0.095}	1.6
60	60 ^{+0.030} ₀	64.2 ^{+0.3} ₀	14 ^{+0.275} _{+0.095}	1.6
70	70 ^{+0.030} ₀	75.0 ^{+0.3} ₀	16 ^{+0.275} _{+0.095}	2
80	80 ^{+0.030} ₀	85.5 ^{+0.3} ₀	18 ^{+0.275} _{+0.095}	2
100	100 ^{+0.035} ₀	107.0 ^{+0.3} ₀	24 ^{+0.32} _{+0.11}	2.5

● Type B

Diameter	øDH ₇	E	F	r
1/2	12.70 ^{+0.018} ₀	14.17 ^{+0.25} ₀	2.38 ^{+0.31} _{+0.13}	0.5
5/8	15.875 ^{+0.018} ₀	17.74 ^{+0.25} ₀	3.18 ^{+0.31} _{+0.13}	0.8
3/4	19.050 ^{+0.021} ₀	20.89 ^{+0.25} ₀	3.18 ^{+0.31} _{+0.13}	0.8
7/8	22.225 ^{+0.021} ₀	24.07 ^{+0.25} ₀	3.18 ^{+0.31} _{+0.13}	0.8
1	25.40 ^{+0.021} ₀	28.04 ^{+0.25} ₀	6.35 ^{+0.31} _{+0.13}	1.2
1 1/4	31.750 ^{+0.025} ₀	35.18 ^{+0.25} ₀	7.94 ^{+0.32} _{+0.14}	1.6
1 1/2	38.10 ^{+0.025} ₀	42.32 ^{+0.25} ₀	9.53 ^{+0.89} _{+0.25}	1.6
1 3/4	44.450 ^{+0.025} ₀	49.48 ^{+0.25} ₀	11.11 ^{+0.89} _{+0.25}	1.6
2	50.80 ^{+0.03} ₀	55.83 ^{+0.25} ₀	12.7 ^{+0.89} _{+0.25}	1.6
2 1/2	63.50 ^{+0.03} ₀	69.42 ^{+0.25} ₀	15.81 ^{+0.89} _{+0.25}	1.6
3	76.20 ^{+0.03} ₀	82.93 ^{+0.25} ₀	19.05 ^{+0.89} _{+0.25}	2.4
3 1/2	88.90 ^{+0.035} ₀	98.81 ^{+0.25} ₀	22.23 ^{+0.89} _{+0.25}	2.4
4	101.60 ^{+0.035} ₀	111.51 ^{+0.25} ₀	25.4 ^{+0.89} _{+0.25}	2.4
4 1/2	114.30 ^{+0.035} ₀	125.81 ^{+0.25} ₀	25.58 ^{+0.89} _{+0.25}	3.2
5	127.0 ^{+0.04} ₀	140.08 ^{+0.25} ₀	31.75 ^{+0.89} _{+0.25}	3.2



Endmill's shape and names



The comparison according to number of flute

Features of number of flute

Ø10 mm	2 flutes	3 flutes	4 flutes
Shape			
Cross section	44 mm ²	46 mm ²	48 mm ²
Ratio	56%	58%	61%
Advantages	Good chip flow	Good chip flow	High rigidity
Disadvantages	Weak rigidity	Difficult to measure external diameter	Bad chip flow
Usages	Side facing, Grooving	Side facing, Grooving	Side cutting
	Multi-functional	Medium, finishing	Finishing

Affection of number of flute

Specification	Major features	2 flutes	4 flutes
Tool rigidity	Torsional rigidity	○	◎
	Bending rigidity	○	◎
Surface finish	Surface roughness	○	◎
	Machining precision	○	◎
Chip control	Chip clogging	◎	○
	Chip evacuation	◎	○
Grooving	Chip evacuation	◎	○
	Grooving	◎	○
Side facing	Surface finish	○	◎
	Vibration	◎	○

◎: Excellent ○: Good

The differences between general endmills and high speed endmills

General endmills		High speed endmills	
Cross section shape	Features	Cross section shape	Features
	<ul style="list-style-type: none"> - Applied for Low speed, High depth of cut, Low feed - Low hardness workpiece (general steel, cast iron) 		<ul style="list-style-type: none"> - Applied for high speed, low depth of cut, high feed - Useful for hardened workpiece such as die steel

Calculations of cutting condition

Calculations of Cutting speed

$$vc = \frac{\pi \times D \times n}{1000} \quad n = \frac{1000 \times vc}{\pi \times D}$$

Calculations of feed speed

$$vf = n \times fn \quad \text{or} \quad n \times fz \times z$$

$$fn = \frac{vf}{n} \quad fz = \frac{fn}{z} \quad \text{or} \quad \frac{vf}{n \times z}$$

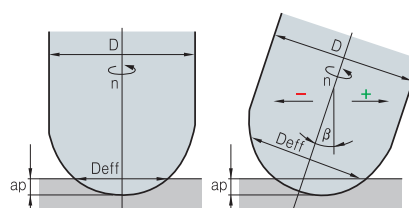
vc: Cutting speed (m/min)
 π: Circular constant (3.141592)
 D: Endmill diameter (mm)
 n: Revolution per minute (min⁻¹)

vf: Feed speed (m/min)
 fn: Feed per revolution (mm/rev)
 fz: Feed per flute (mm/t)
 z: Number of flute

Ball endmills cutting speed calculation formulas

Revolution per minute	$n = \frac{vc \times 1000}{D \times \pi}$
Cutting speed	$vc = \frac{D \times \pi \times n}{1000}$
Feed per tooth	$fz = \frac{vf}{z \times n}$
Feed per revolution	$fn = fz \times z$
Feed speed	$vf = fz \times z \times n$
Chip removal rate	$Q = ae \times ap \times vf$

Effective diameter of Ball Endmill



$$D_{\text{eff}} = 2 \times \sqrt{D \times ap - ap^2} \quad \text{Calculation Table}$$

$$D_{\text{eff}} = D \times \sin \left[\beta \pm \arccos \left(\frac{D - 2ap}{D} \right) \right]$$

Technical Information for Endmills

The affection of flute length

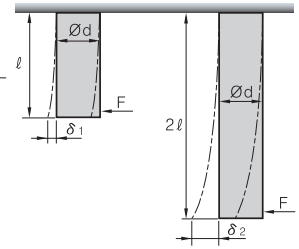
● Expression of aspect ratio

- Aspect ratio
- l/d
- Ex) 3D, 15D, 22D

● Deformation rate according to length

- Deformation rate is reaction force against external force
- Proportional to the cube of length
- Set flute length and overall length as short as possible
- The more flute the better rigidity
- When flute width rate is narrower drill's rigidity is higher

$$\delta = \frac{P\ell^3}{3EI}$$



δ = Deformation volume l = Length of cut

P = Cutting force E = Elasticity coefficient

$$I = \text{Inertia moment} \left(I = \frac{\pi d^4}{64} \right)$$

• $l : 2l$

• $\delta_1 : \delta_2 = 8\delta_1 = \delta_2$

Spindle revolution conversion table (RPM) - external diameter

vc External	Cutting speed (vc, m/min)															
	20	30	40	50	60	70	80	90	100	120	140	150	180	200	250	300
0.2	31,831	47,746	63,662	79,577	95,493	111,408	127,324	143,239	159,155	190,986	222,817	238,720	286,479	318,310	397,887	477,465
0.3	21,221	31,831	42,441	53,052	63,662	74,272	84,883	95,493	106,103	127,324	148,545	159,155	190,986	212,207	265,258	318,310
0.4	15,915	23,873	31,831	39,789	47,746	55,704	63,662	71,620	79,577	95,493	111,408	119,366	143,239	159,155	198,944	238,732
0.5	12,732	19,099	25,465	31,831	38,197	44,563	50,930	57,296	63,662	76,394	89,127	95,493	114,592	127,324	159,155	190,986
0.6	10,610	15,915	21,221	26,526	31,831	37,136	42,441	47,746	53,052	63,662	74,272	79,577	95,493	106,103	132,629	159,155
0.7	9,095	13,642	18,189	22,736	27,284	31,831	36,378	40,926	45,473	54,567	63,662	68,209	81,851	90,946	113,682	136,419
0.8	7,958	11,937	15,915	19,894	23,873	27,852	31,831	35,810	39,789	47,746	55,704	59,683	71,620	79,577	99,472	119,366
0.9	7,074	10,610	14,147	17,684	21,221	24,757	28,294	31,831	35,368	42,441	49,515	53,052	63,662	70,736	88,419	106,103
1	6,366	9,549	12,732	15,915	19,099	22,282	25,465	28,648	31,831	38,197	44,563	47,746	57,296	63,662	79,577	95,793
1.5	4,244	6,366	8,488	10,610	12,732	14,854	16,977	19,099	21,221	25,465	29,709	31,831	38,197	42,441	53,052	63,662
2	3,183	4,775	6,366	7,958	9,549	11,141	12,732	14,324	15,915	19,099	22,282	23,873	28,648	31,831	39,789	47,746
2.5	2,546	3,820	5,093	6,366	7,639	8,913	10,186	11,459	12,732	15,279	17,825	19,099	22,918	25,465	31,831	38,197
3	2,122	3,183	4,244	5,305	6,366	7,427	8,488	9,549	10,610	12,732	14,854	15,915	19,099	21,221	26,526	31,831
3.5	1,819	2,728	3,638	4,547	5,457	6,366	7,276	8,185	9,095	10,913	12,732	13,642	16,370	18,189	22,736	27,284
4	1,592	2,387	3,183	3,979	4,775	5,570	6,366	7,162	7,958	9,549	11,141	11,937	14,324	15,915	19,894	23,873
4.5	1,415	2,122	2,829	3,537	4,244	4,951	5,659	6,366	7,074	8,488	9,903	10,610	12,732	14,147	17,684	21,221
5	1,273	1,910	2,546	3,183	3,820	4,456	5,093	5,730	6,366	7,639	8,913	9,549	11,459	12,732	15,915	19,099
5.5	1,157	1,736	2,315	2,894	3,472	4,051	4,630	5,209	5,787	6,945	8,102	8,681	10,417	11,575	14,469	17,362
6	1,061	1,592	2,122	2,653	3,183	3,714	4,244	4,775	5,305	6,366	7,427	7,958	9,549	10,610	13,263	15,915
6.5	979	1,469	1,959	2,449	2,938	3,428	3,918	4,407	4,897	5,876	6,856	7,346	8,815	9,794	12,243	14,691
7	909	1,364	1,819	2,274	2,728	3,183	3,638	4,093	4,547	5,457	6,366	6,821	8,185	9,095	11,368	13,642
7.5	849	1,273	1,698	2,122	2,546	2,971	3,395	3,820	4,244	5,093	5,942	6,366	7,639	8,488	10,610	12,732
8	796	1,194	1,592	1,989	2,387	2,785	3,183	3,581	3,979	4,775	5,570	5,968	7,162	7,958	9,947	11,937
8.5	749	1,123	1,498	1,872	2,247	2,621	2,996	3,370	3,745	4,494	5,243	5,617	6,741	7,490	9,362	11,234
9	707	1,061	1,415	1,768	2,122	2,476	2,829	3,183	3,537	4,244	4,951	5,305	6,366	7,074	8,842	10,610
9.5	670	1,005	1,340	1,675	2,010	2,345	2,681	3,016	3,351	4,021	4,691	5,026	6,031	6,701	9,377	10,052
10	637	955	1,273	1,592	1,910	2,228	2,546	2,865	3,183	3,820	4,456	4,775	5,730	6,366	7,958	9,549
11	579	868	1,157	1,447	1,736	2,026	2,315	2,604	2,894	3,472	4,051	4,341	5,209	5,787	7,234	8,681
12	531	796	1,061	1,326	1,592	1,857	2,122	2,387	2,653	3,183	3,714	3,979	4,775	5,305	6,631	7,958
13	490	735	979	1,224	1,469	1,714	1,959	2,204	2,449	2,938	3,428	3,673	4,407	4,897	6,121	7,346
14	455	682	909	1,137	1,364	1,592	1,819	2,046	2,274	2,728	3,183	3,410	4,093	4,547	5,684	6,821
15	424	637	849	1,061	1,273	1,485	1,698	1,910	2,122	2,546	2,971	3,183	3,820	4,244	5,305	6,366
16	398	597	796	995	1,194	1,393	1,592	1,790	1,989	2,387	2,785	2,984	3,581	3,979	4,974	5,968
17	374	562	749	969	1,123	1,311	1,498	1,685	1,872	2,247	2,621	2,809	3,370	3,745	4,681	5,617
18	354	531	707	884	1,061	1,238	1,415	1,592	1,768	2,122	2,476	2,653	3,183	3,537	4,421	5,305
19	335	503	670	838	1,005	1,173	1,340	1,508	1,675	2,010	2,345	2,513	3,016	3,351	4,188	5,026
20	318	477	637	796	955	1,114	1,273	1,432	1,592	1,910	2,228	2,387	2,865	3,183	3,979	4,775
21	303	455	606	758	909	1,061	1,213	1,364	1,516	1,819	2,122	2,274	2,728	3,032	3,789	4,547
22	289	434	579	723	868	1,013	1,157	1,302	1,447	1,736	2,026	2,170	2,604	2,894	3,617	4,341
23	277	415	554	692	830	969	1,107	1,246	1,384	1,661	1,938	2,076	2,491	2,768	3,460	4,152
24	265	398	531	663	796	928	1,061	1,194	1,326	1,592	1,857	1,989	2,387	2,653	3,316	3,979
25	255	382	509	637	764	891	1,019	1,146	1,273	1,528	1,783	1,910	2,292	2,546	3,183	3,820



🔍 Tool failure and trouble shooting

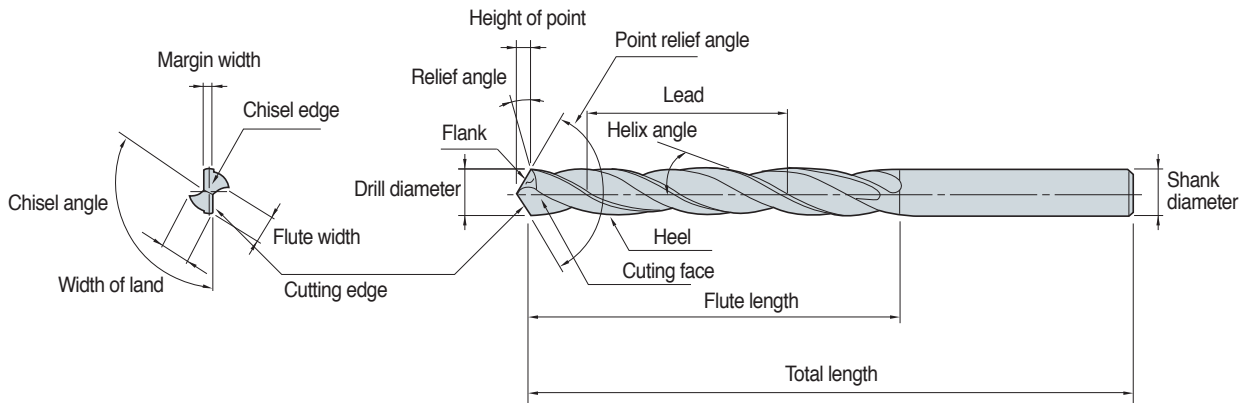
Trouble	Causes	Solutions																
		Cutting condition					Tool shape					Grade		etc				
		Cutting speed	Feed	Depth of cut	Coolant	Up cut-down cut	Relief angle	Lead angle	Length of flute	Number of flute	Honing	Chip pocket	Toughness	Hardness	Machine rigidity	Machine vibration	Workpiece fixing	Overhang
Damage at cutting edge	Excessive periphery cutting edge	↓	↑		●												↑	
	Chipping		↓			↓	↓			●		↑				↓	↑	↓
	Fracture during operation		↓	↓				↓			↑			↑		↑		↓
Poor surface finish	Generating built-up edge	↑	↑		●			↑		●								
	Chattering	↓				↓		↓						↑	↓	↑	↓	
	Poor straightness		↓	↓		↑		↑	↓									↓
Poor machining precision (Machined size, perpendicularity)	Improper cutting conditions Improper tool shape	↑	↓			↓		↓	↑					↑	↓		↓	
Bad chip evacuation	Excessive cutting volume Improper chip pocket Improper cutting conditions		↓	↓					↓		↑							

↑ : Increase ↓ : Decrease ● : use ○ : Correct use



Technical Information for Drills

The shape of drills and the names



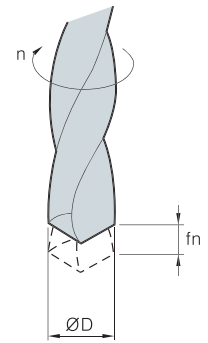
Shape and the feature of cutting

Helix angle	<p>Plays rake angle of cutting edge's role. If helix angle increases Cutting force decreases. On the other hand If helix angle is too big Drill rigidity decreases</p> <p>Poor machinability ◀ low - Helix angle - high ▶ Hard workpiece (hardened steel) ▶ soft material (aluminum etc)</p>												
Length of flute	<p>The path of both chip evacuation and cooling lubricant Too big length of flute weakens drill rigidity and too small length of flute worsens chip evacuation to breakage</p>												
Point angle	<p>Point angle has big influence on cutting performance. It mainly depends on workpiece. In case of standard drills Point angle is generally 118</p> <p>thrust resistance decrease ◀ low - Point angle - high ▶ thrust resistance increase Torque increase, Burr on exit increase ▶ soft material (aluminum etc) ▶ Hard workpiece (hardened steel) Soft material (aluminum etc) ▶ Hard workpiece (hardened steel)</p>												
Margin	<p>While machining Margin is the part of contact between workpiece and drill's external. It prevents bending and plays guide's role It depends on drill size</p> <p>Cutting force decrease ◀ small - Margin - big ▶ Cutting force increase Poor guide ▶ Good guide</p>												
Web thickness	<p>Web is the part of center of drill and drill's rigidity depends on the web. Drill needs cutting edge, chisel edge, at the tip of drill because drill makes a hole at the beginning of drilling . When web thickness is big Thinning is needed to reduce cutting force</p> <p>Cutting force decrease ◀ small - Web thickness - big ▶ Cutting force increase Rigidity decrease ▶ Rigidity increase Good chip evacuation ▶ Bad chip evacuation Soft material (aluminum etc) ▶ Hard workpiece (hardened steel)</p>												
Back taper	<p>Drill diameter size is getting smaller from point to shank in order to avoid the friction between drill periphery and workpiece. The decrease of diameter divided by flute length 100mm generally becomes 0.04~0.1mm. As for high performance drills and drills for hole shrinkage workpiece during operation have big back taper</p>												
Thinning	<p>In general drills Thrust effects on chisel over 50%. Chisel edge length depends on web thickness and chisel angle. But if web is thin Drill rigidity weaken. Therefore without web thickness change Thinning makes chisel edge short or gives rake angle. In other words, Thinning makes rake angle at chisel and improves chip evacuation and decrease thrust</p> <table border="1" style="width: 100%; border-collapse: collapse;"> <thead> <tr> <th style="width: 20%;">Types of</th> <th style="width: 20%;">Edge shape</th> <th style="width: 30%;">Feature</th> <th style="width: 30%;">Korloy's drills</th> </tr> </thead> <tbody> <tr> <td style="text-align: center;">X type</td> <td style="text-align: center;"></td> <td> Good centering High central thickness Crank shaft </td> <td> Mach solid drill (MSD) Vulcan drill (VZD) </td> </tr> <tr> <td style="text-align: center;">S type</td> <td style="text-align: center;"></td> <td> For wide use For general Easy regrinding </td> <td> Solid drill (SSD) </td> </tr> </tbody> </table>	Types of	Edge shape	Feature	Korloy's drills	X type		Good centering High central thickness Crank shaft	Mach solid drill (MSD) Vulcan drill (VZD)	S type		For wide use For general Easy regrinding	Solid drill (SSD)
Types of	Edge shape	Feature	Korloy's drills										
X type		Good centering High central thickness Crank shaft	Mach solid drill (MSD) Vulcan drill (VZD)										
S type		For wide use For general Easy regrinding	Solid drill (SSD)										



Major cutting formulas

Cutting speed	Feed	Helix angle	Machining time
$vc = \frac{\pi \cdot D \cdot n}{1000} \text{ (m/min)}$ <ul style="list-style-type: none"> vc: Cutting speed (m/min) D: Drill diameter (mm) n: Revolution per minute (min⁻¹) π: Circular constant (3.14) 	$fn = \frac{vf}{n} \text{ (mm/rev)}$ <ul style="list-style-type: none"> fn: Feed per revolution (mm/rev) vf: Feed per minute (mm/min) n: Revolution per minute (min⁻¹) 	$\delta = \tan^{-1} \left(\frac{\pi D}{L} \right)$ <ul style="list-style-type: none"> δ: Helix angle D: Drill diameter (mm) L: Lead (mm) π: Circular constant (3.14) 	$tc = \frac{ld}{n \cdot fn} \text{ (min)}$ <ul style="list-style-type: none"> tc: Machining time (min) n: Revolution per minute (min⁻¹) ld: Drilling time (mm) fn: Feed (mm/rev)



Cutting torque and thrust (calculation formulas)

$Md = KD^2 \times (0.0631 + 1.686 \times fn) \text{ (kg·cm)}$	<ul style="list-style-type: none"> Md: Cutting torque (kg·cm) T: Cutting thrust (kg) D: Drill diameter (mm) 	<ul style="list-style-type: none"> fn: Feed per revolution (mm/rev) K: Material coefficient
$T = 57.95KDfn^{0.88} \text{ (kg)}$		

Workpiece material (SAE/AISI)		Tensile strength (kgf)	Hardness (HB)	Material coefficient K
Cast iron	Cast iron (Gray)	21	177	1.00
	Cast iron	28	198	1.39
	Cast iron (Ductile)	35	224	1.88
General steel	1020(carbon steel C 0.2%)	55	160	2.22
	1112(C 0.12, S 0.2%)	62	183	1.42
	1335(Mn 1.75%)	63	197	1.45
Nickel Chrome steel	3115 (Ni 1.25, Cr 0.6, Mn 0.5)	53	163	1.56
	3120 (Ni 1.25, Cr 0.6, Mn 0.7)	69	174	2.02
	3140	88	241	2.32
Chrome molybdenum steel	4115 (Cr 0.5, Mo 0.11, Mn 0.8)	63	167	1.62
	4130 (Cr 0.95, Mo 0.2, Mn 0.5)	77	229	2.10
	4140 (Cr 0.95, Mo 0.2, Mn 0.85)	94	269	2.41
Nickel molybdenum steel	4615 (Ni 1.8, Mo 0.25, Mn 0.5)	75	212	2.12
	4820 (Ni 3.5, Mo 0.25, Mn 0.6)	140	390	3.44
Chrome steel	5150 (Cr 0.8, Mn 0.8)	95	277	2.46
Chrome vanadium steel	6115 (Cr 0.6, Mn 0.6, V 0.12)	58	174	2.08
	6120 (Cr 0.8, Mn 0.8, V 0.1)	80	255	2.22

Cutting torque and thrust (empirical formula)

$Md = K_1 d^2 \cdot fn^m$	<ul style="list-style-type: none"> Md: Cutting torque (kg·cm) 	<ul style="list-style-type: none"> fn: Feed (mm/rev) 	<ul style="list-style-type: none"> d: Drill diameter (mm)
$T = K_2 d \cdot fn^n$	<ul style="list-style-type: none"> T: Thrust (kg) 	<ul style="list-style-type: none"> K₁, K₂, m, n: Experimental Data Characteristic value 	

Workpiece	K ₁	m	K ₂	n
Soft steel	5.9	1.00	125.0	0.88
Rolled steel	3.5	1.00	55.0	0.88
7-3 brass	2.5	0.94	44.4	0.87
Aluminum	1.5	0.90	33.3	0.78
Zinc	1.4	0.88	27.0	0.74
Gun metal	2.0	0.94	21.6	0.75
Galvanized iron	0.3	0.57	6.4	0.55



Tool failures and solutions

Trouble	Causes	Solutions																
		Cutting condition					Tool shape					Grade		etc				
		Cutting speed	Feed	Step feed	Initial feed	Coolant	Relief angle	Point angle	Thinning angle	Honing	Flute width rate	Thinning	Toughness	Hardness	Machine rigidity	Machine vibration	Guide bush	Clamping workpiece
Chipping	• Too sharp cutting edge (too big relief angle) (thinning edge is too sharp)						↓		↓	↑				↑				
	• Excessive cutting speed	↓				●												
	• Built-up edge					●	↓		↓	↑				↑				
	• Vibration and chattering	↓													↑	↓	●	
Wear	• Excessive cutting speed (Abnormal wear at margin)	↓				●												
	• Insufficient cutting speed (Abnormal wear at center)	↑				●												
Chip	• Long chip	↑	↑			●				↓								
	• Over lap	↑	↑															
	• Chip burning	↑				●												
Hole precision burr, poor surface finish	• Tool clamping precision				↓		↓		↓						↑	↓	●	
	• Excessive feed, sharp point angle		↓					↑	↓									
	• Excessive cutting speed (Considered tool grade)	↑				●	↓	⊙					↑					
Fracture	Breakage on contact	• Poor surface finish			●	↓											●	
		• Insufficient machine rigidity													↑		●	
		• Improper cutting condition	↑	↓														
	Breakage at hole bottom	• Crooked hole	↑						↑				●			↓	●	
		• Chip clogging		↓	●							↑						

↑: Increase ↓: Decrease ●: use ⊙: Correct use



🔍 Hole size for threading

● Metric coarse screw threads

Specification	Hole diameter
M1 X 0.25	0.75
M1.1 X 0.25	0.85
M1.2 X 0.25	0.95
M1.4 X 0.3	1.1
M1.6 X 0.35	1.25
M1.7 X 0.35	1.35
M1.8 X 0.35	1.45
M2 X 0.4	1.6
M2.2 X 0.45	1.75
M2.3 X 0.4	1.9
M2.5 X 0.45	2.1
M2.6 X 0.45	2.2
M3 X 0.6	2.4
M3 X 0.5	2.5
M3.5 X 0.6	2.9
M4 X 0.75	3.25
M4 X 0.7	3.3
M4.5 X 0.75	3.8
M5 X 0.9	4.1
M5 X 0.8	4.2
M5.5 X 0.9	4.6
M6 X 1	5
M7 X 1	6
M8 X 1.25	6.8
M9 X 1.25	7.8
M10 X 1.5	8.5
M11 X 1.5	9.5
M12 X 1.75	10.3
M14 X 2	12
M16 X 2	14
M18 X 2.5	15.5
M20 X 2.5	17.5
M22 X 2.5	19.5
M24 X 3	21
M27 X 3	24
M30 X 3.5	26.5
M33 X 3.5	29.5
M36 X 4	32
M39 X 4	35
M42 X 4.5	37.5
M45 X 4.5	40.5
M48 X 5	43

● Metric coarse screw threads

Specification	Hole diameter
M2.5 X 0.35	2.2
M3 X 0.35	2.7
M3.5 X 0.35	3.2
M4 X 0.5	3.5
M4.5 X 0.5	4
M5 X 0.5	4.5
M5.5 X 0.5	5
M6 X 0.75	5.3
M7 X 0.75	6.3
M8 X 1	7
M8 X 0.75	7.3
M9 X 1	8
M9 X 0.75	8.3
M10 X 1.25	8.8
M10 X 1	9
M10 X 0.75	9.3
M11 X 1	10
M11 X 0.75	10.3
M12 X 1.5	10.5
M12 X 1.25	10.8
M12 X 1	11
M14 X 1.5	12.5
M14 X 1	13
M15 X 1.5	13.5
M15 X 1	14
M16 X 1.5	14.5
M16 X 1	15
M17 X 1.5	15.5
M17 X 1	16
M18 X 2	16
M18 X 1.5	16.5
M18 X 1	17
M20 X 2	18
M20 X 1.5	18.5
M20 X 1	19
M22 X 2	20
M22 X 1.5	20.5
M22 X 1	21
M24 X 2	22
M24 X 1.5	22.5
M24 X 1	23
M25 X 2	23
M25 X 1.5	23.5
M25 X 1	24
M26 X 1.5	24.5
M27 X 2	25

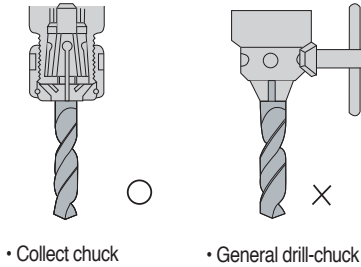


Technical Information for Drills

⚠ Cautions

● Selection of drill chuck

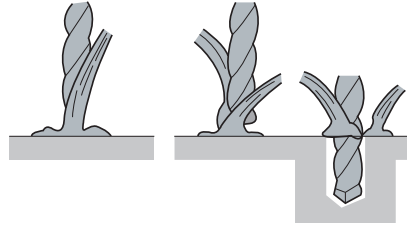
- Collect chuck is favorable Because it has strong grip power (General drill-chuck and Keyless chuck don't have enough grip power.)



• Collect chuck • General drill-chuck

● Coolant supply

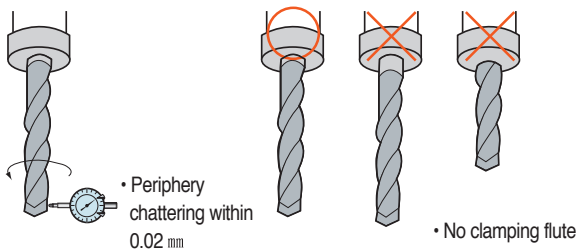
- Supply enough coolant around hole entrance
- Standard cutting oil pressure: 3~5 kg/cm², Flux: 2~5 l/min



• Supply much coolant at hole entrance

● Mounting drill

- When mounting drill Periphery chattering should be within 0.02 mm
- Flute should not be clamped

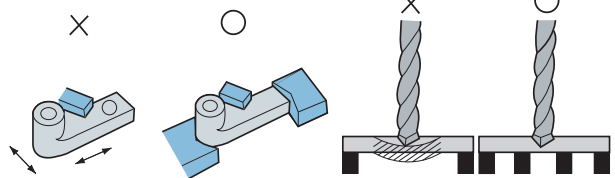


• Periphery chattering within 0.02 mm

• No clamping flute

● How to clamp workpiece

- At high performance drilling High thrust, torque and horizontal cutting force work at the same time so that workpiece should be clamped strongly to prevent chattering



• Uniformed and strong clamping is needed (Right and left, up and down)

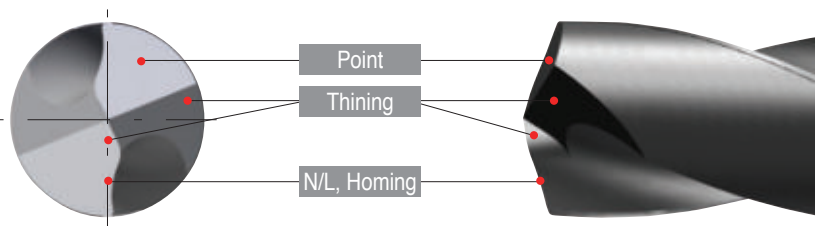
• Strong clamping is needed because bending causes chipping

⚠ Notice

- 1) For better drill's life, small damage and wear are favorable to be regrinding
- 2) Damage and wear size should be within 1.5 mm for regrinding
- 3) If drill has crack, regrinding is impossible
- 4) Ordering for regrinding is acceptable or purchase regrinding machine

⚠ Regrinding procedures

● Regrinding method (Mach Drill)



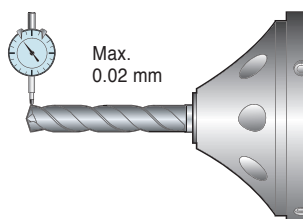
1) Preparation Determination of regrinding areas

- Check the cutting edge for damage and wear If large fracture is found, remove it by rough grinding



2) Grinding operation Drills setting

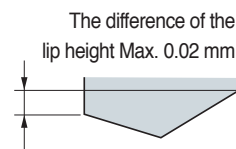
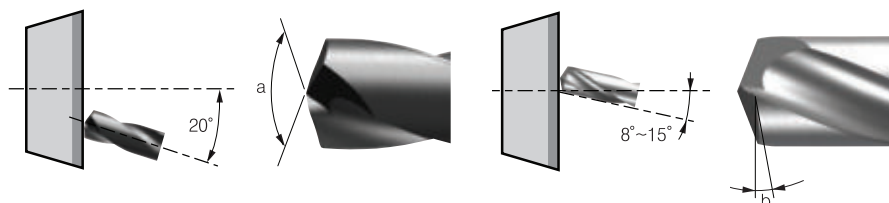
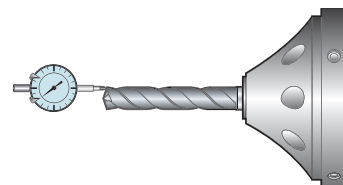
- Drill is clamped to collet chuck Chattering is kept within 0.02 mm



3) Grinding operation-Grinding point

- Check damage and wear at the point and remove it completely
- The difference of the lip height is kept within 0.02 mm

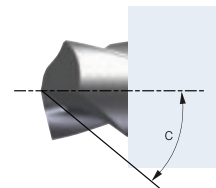
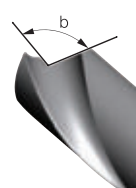
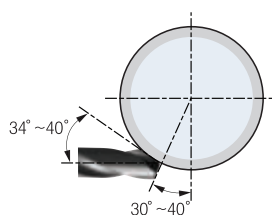
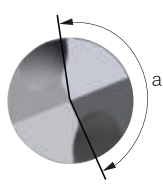
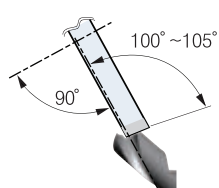
Point angle (a): 140°
Point relief angle (b): 8°~15°



4) Grinding operation-Thinning grinding

- Considering N/L width Cutting edge length from the center of drill axis should be 0.03~0.08mm for balancing
- Set the wheel to tilt drill axis by 34°~40°.

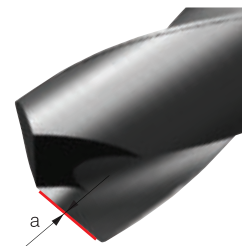
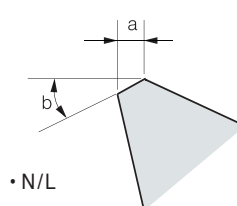
Thinning angle (a): 155°~160° Thinning open angle (b): 100°~105°
Thinning relief angle (c): 34°~40°



5) Grinding-N/L grinding and honing

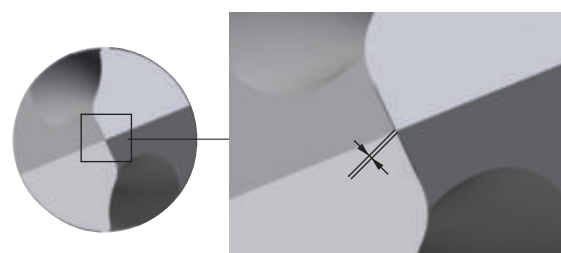
- Using diamond chisel Grinds the width flat along point cutting edge
- After negaland operation Finishes with brush or handstone

N/L width (a): 0.05mm~0.16mm/N/L angle (b): 24°~26°



● TIP

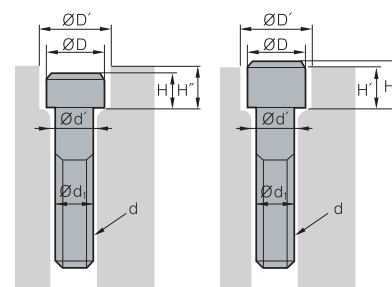
- Making point
 - Without center drill, the point width should be below 0.10 mm
- Recommended grinding condition
 - Diamond wheel: 240~400 mesh
 - Diamond chisel: 400~600 mesh
 - Diamond hand stone: 800~1500 mesh



➤ Hexagonal socket bolt (clamping screw) size

● Counter boring and size of bolt hole for hexagonal socket bolt

ISO (d)	M3	M4	M5	M6	M8	M10	M12	M14	M16	M18	M20	M22	M24	M27	M30
Ød _i	3	4	5	6	8	10	12	14	16	18	20	22	24	27	30
Ød'	3.4	4.5	5.5	6.5	8.5	11	14	16	18	20	22	24	26	30	33
ØD	5.5	7	8.5	10	13	16	18	21	24	27	30	33	36	40	45
ØD'	5	8	9.5	11	14	17.5	20	23	26	29	32	35	39	43	48
H	3	4	5	6	8	10	12	14	16	18	20	22	24	27	30
H'	2.7	3.6	4.6	5.5	7.4	9.2	11.0	12.8	14.5	16.5	18.5	20.5	22.5	25	28
H''	3.3	4.4	5.4	6.5	8.6	10.8	13.0	15.2	17.5	19.5	21.5	23.5	25.5	29	32



General Information II

The comparison of chip breakers

Application			KORLOY	KYOCERA	TAEGUTEC	SUMITOMO	SANDVIK	KENNAMETAL	ISCAR	WLATER	MITSUBISHI	SECO	TUNGALLOY		
Negative	P	Application	Ultra-Finishing	- VL	DP (G-class) GP	- FA	FA FL, FB	PMC QF	FF (G-class) UF	SF PF	- NF3	PK (G-class), FY FH, FS, SY	FF1 FF2	TF NS, ZF	
			Finishing	VF, VB -	PP -	FG SF	LU, FE SU	PF, XF 61	FN K	NF, SM F3P	NF4 FP5	FP LP, SH, SA		NM, NS, SS TS, TSF	
		Medium to finishing	VC LP, CP	HQ, CQ PQ, CJ	MC FC	SE SX	HM PMC	LF, CT -	TF -	NS6 MP3	C(Cermet) MV			AS ZM, AM	
			Medium machining	VM, HM MP	HK, GS, HS, PS PG	MP, MT PC	GU(UG) GE, UX	QM, SM PM, XM	MP, MN -	PP, TF M3P	NM4, NP5 MP5	MA, MH MP	M3, M5 -		TQ, TM DM, None C/B
		Roughing	B25 GR					- PR, WR	RP, MR RN, None C/B	GN R3P	- RP5, MN9	GM, None C/B GH, RP	M5 MR5, MR6, MR7		TH THS
			Heavy duty machining	GH VH VT	PX - -	HB, RH, RX HZ, EH HT, HY, HD	HG, MP HP HU, HW, HF	PR, XMR QR HR	RH RM MM	NR, HT HR T3P	RP7, NR4, NRF NRR, NR8 -	HZ HX HV	R4, R5 R6, R7, R8, PR6 PR9, R56, R57, R68		CH THS, TRS 65, TUS
	Low carbon steel	Soft steel	VL	XF, XP, XP-T XQ, XS	SF -	FL -	LC -	- -	- -	- -	FY SY	- -	- -	- -	
			High feed	Wiper	VW LW -	WP, WF WQ, WE -	WS WT -	LUW, SEW GUW -	WF, WL WM, WMX WR	FW MW RW	WF WG -	NF NM -	SW MW -	FF2, MF2 MF5, M3 R4, R7	AFW, FW ASW, SW -
	Application	Shaft (long bar)	SH KNUX-	CJ, ST KNMX-	FS, VF, FX KNUX-	HM -	K KNUX-71	- -	- -	- -	- -	ES KNMX-19	UX -	P, S KNMX	
			M	Stainless steel	Finishing	VP2, MP	MQ, GU, SK	EA, SF	SU, EF	MF, XF	FP, FF	SF, VL, F3M	NF4, FM5	SH, LM	FF1, MF1
Medium cutting	MM	HU, TK, MS			MP, EM	EX, EG, GU	MM, XM, QM, MMC	MP, UP, MS	PP, TF, M3M	NM4, NR4	MS, GM, MM	MF3, MF4	SM		
Roughing	RM	MU			ET	MU, HM, EM	MR, XMR, MRR	RP, P	MR, R3M	RM5, NRS	MA, ES	MF5, M5	S, SH		
K	Cast iron	Finishing	MP	None C/B, C, KQ	MT	UZ	KF, PMC, XF	T-20, FN	TF	NM, MK5	LK, MA	M4	CF		
		Medium cutting	B25, MK	ZS, KG	RT, KT	UX, GZ	KM, XM	UN, RP	GN	NM5, RK5	MK, GK, None C/B	M5	CM, None C/B		
		Roughing	-MA, RK	-MA, GC, KH	-MA	-MA	KR, XMR, KRR	MR, S-20, -MA	-MA, NR	-MA, RK7	RK, -MA	MR7	CH		
S	HRSA	Ultra-finishing	VP1	MQ, SK	EA	EF	SF, SGF	FS (G-class) LF (G-class)	SF, PF	NF4	FJ(G-class)	M1	SF		
		Finishing	VP2	TK	ML	UP, EG	23.SR, XF, SMC	UP	PP	NFT	LS	MF1	HMM		
		Medium cutting	VP3	MS	EM	EX	SM, SMR, XM	MS, GP, P, UN	TF	NMS, NMT	MS	MF4, MR3	HRF		
		Roughing	VP4	MU	ET	MU	XMR	RP	MR	NRS, NRT	RS, GJ	MR4	HRM		
N	Aluminium alloy	HA	AH	ML	AX	23	GP, MS	NF, PP	FN2, PF2, MN2, PM2	MJ	MF1	P			
Positive	P M K	Application	Finishing	FP	XP, PP	FA, FX	FC	PF, XF	11	PF	FP4	SMG (G-class), FV	FF1	01	
				VL, VF	GP	-	FB, LU(FP, FK)	UF	UF	F3P	FK6	SV, FP	F1	PSF, PF	
			Medium cutting	HMP	XQ	FG	LB, NF	PM, XM	LF, FP	14	MP4, FM2, FM4, MK4	LP	MF2	PSS	
				MP	HQ, GK	PC, FM	SU, SC	UM, PMC	MP, T-20	SM	FP6, MM4, FM6, RK4	MV	F2, M3	PS	
	Roughing	C25	None C/B	MT	MU	PR, UR, XR	MF, GM, -C	19	RP4, RM4, RK6	None C/B, MP	M5	PM			
	Wiper	-	WP	-	LUW	WL, WF	FW	WF	PM	SW	-	-			
		-	-	WT	SDW	WM, WMX	MW	WG	-	MW	-	-			
	M S	Stainless steel For HRSA	Finishing	FS, MS, VP1	CF, GF, GQ	FG	FC, FM	MF, MM, MMC	11, UF, LF	PF	FM4, NM4	FJ (G-class), FM, LM	F1, MF2	PSF, PSS	
			Medium to finish cutting	FP, VL, LU	MQ	SA	LB, SI	MR, XR	MF	SM	RM4	MM	M3	PS	
			Medium cutting	MU	MF	-	-	SMC	-	M3M	-	None C/B	M5	CM	
K	Cast iron	Medium cutting	MP	HQ	PC	MU	KF, KM	LF	17	FK6	MK	M3	CM		
		Roughing	C25	GK	MT	None C/B	KR	MF, UF	19	MK4, RK6	None C/B, -MW	M5	None C/B		
N	Aluminium alloy	AK, AR	AH	FL	AW, AG, AY	AL	HP, LF	AS, AF	PM2	AZ, FS	AL	AL			
High precision bar turning (tolerance class G&E)			KF, KM	FSF, USF, J, A3	GF, FF, GW	FY, FX, FZ	K, F, UM	GH	LF, RF, XL	-	F, SR, SS, SM	UX	JS, J10, JRP, JPP		



KORLOY grades

Cat.	Grade	ISO						Turning	Multi functional tools	Threading	Milling	Endmill	Index drill	Solid drill	Brazen tools	Coating layer
		P	M	K	S	N	H									
CVD	NC3215	P10-P15						●								
CVD	NC3225	P20-P25						●	●							
CVD	NC3120	P20-P25						●	●							
CVD	NC3030	P25-P35						●	●							
PVD	PC3030T	P35-P45	M25-M35							●						
PVD	PC3035	P30-P40							●							
CVD	NC6310			K01-K10				●								
CVD	NC6315			K10-K20				●	●							
PVD	PC8105		M05-M15		S01-S10			●								
PVD	PC8110		M10-M20		S05-S15			●	●							
PVD	PC8115		M15-M25		S10-S20			●								
PVD	PC8120				S15-S25			●								
CVD	NC9115		M10-M20					●								
CVD	NC9125		M20-M30		S10-S20			●								
CVD	NC9135		M30-M40		S15-S25			●								
PVD	PC9030		M25-M35					●	●							
PVD	PC9070T		M25-M35							●						
PVD	PC2005					H01-H10				●						
PVD	PC2010					H05-H15				●						
PVD	PC2015					H10-H20				●						
PVD	PC2505					H01-H10				●						
PVD	PC2510					H05-H15				●	●					
PVD	PC210F					H10-H20				●						
CVD	NCM325	P30-P40								●		●				
CVD	NCM335	P35-P45								●						
PVD	PC3700	P25-P40								●		●				
CVD	NC5330	P30-P35	M25-M35	K15-K25				●	●	●		●				
CVD	NCM535	P30-P40		K20-K30					●			●				
CVD	NCM545	P40-P50		K30-K40						●						

Coating



General Information II

KORLOY grades

Cat.	Grade	ISO						Turning	Multi functional tools	Threading	Milling	Endmill	Index drill	Solid drill	Brazen tools	Coating layer
		P	M	K	S	N	H									
Coating	PVD PC5300	P30-P40	M20-M30	K20-K30	S15-S25			●	●	●	●	●			★ New TiAlN film (High hardness/Oxidation resistance)	
	PVD PC5335	P30-P40	M20-M30									●			★ TiAlCrN film (Lubricative)	
	PVD PC5400	P35-P45	M30-M40	K25-K35	S25-S35			●		●					★ TiAlCrN film (Lubricative)	
	PVD PC6510			K05-K15						●		●			TiN TiAlN	
	PVD PC9530		M25-M35							●					TiAlN	
	PVD PC9540		M35-M45		S30-S40					●					Al ₂ O ₃ TiAlN	
Cermet	PVD CC1500 ^{new}	P10-P20		K05-K15				●							★ New TiAlN film (High hardness/Oxidation resistance)	
	PVD CC2500 ^{new}	P20-P30		K10-K15				●							★ New TiAlN film (High hardness/Oxidation resistance)	
	CN1500	P10-P20		K10-K20				●								
	CN2500	P15-P30		K15-K25				●								
	CN30	P25-P35								●						
Uncoated	ST10	P10-P15								●				●		
	ST20	P15-P20							●					●		
	ST30A	P25-P35							●		●					
	U20		M25-M30											●		
	H01			K05-K10	S01-S10	N10-N20	H05-H10	●	●		●	●	●	●		
	H05			K10-K15	S05-S15	N15-N25		●			●					
	G10				K15-K20			●			●			●		
Coating	PVD PC203F						H05-H15					●			★ New TiAlN film (High hardness/Oxidation resistance)	
	PVD PC210C					N10-N20						●			CrN	
	PVD PC215F	P20-P35										●			★ New TiAlN film (High hardness/Oxidation resistance)	
	PVD PC215G	P15-P30		K15-K30								●			TiAlN	
	PVD PC221F	P35-P45		K35-K45							●				★ New TiAlN film (High hardness/Oxidation resistance)	
	PVD PC230F	P05-P15	M05-M15	K05-K15									●		★ New TiAlN film (High hardness/Oxidation resistance)	
	PVD PC303S	P05-P15		K05-K15			H05-H15					●			TiMeN TiAlN	
	PVD PC310U	P10-P20		K10-K20			H10-H20					●			TiMeN TiAlN	
	PVD PC315E	P20-P35		K20-K35								●			AlCrN	
	PVD PC315G	P15-P30		K15-K30									●		TiAlCrN	
	PVD PC320	P20-P35		K20-K35							●				TiAlN	



KORLOY grades

Cat.	Grade	ISO						Turning	Multi functional tools	Threading	Milling	Endmill	Index drill	Solid drill	Brazed tools	Coating layer
		P	M	K	S	N	H									
Coating	PVD PC320S		M20-M30		S20-S30						●					
	PVD PC320U	P01-P10		K05-K10							●					
	PVD SL				S25-S35						●					
	PVD PC325T new				S20-S30								●			
	PVD PC325U	P20-P35	M20-M30	K20-K35										●		
Uncoated	H01					N10-N20					●					
	H05S					N10-N20					●					
	FCC			N15-N35							●					
	FG2	P05-P25				N05-N25							●			
	FA1	P05-P25				N05-N25							●			
cBN	DBN500			K05-K15				●								
	DBN700A			K01-K10				●								
	DB7000	S01-S10						●								
	DB1000					H01-H10		●								
	DB2000					H05-H15		●								
	DBNX20					H15-H25		●								
	DBN250					H15-H25		●								
	DBN400					H15-H25		●								
	PVD DNC100					H01-H10		●								
	PVD DNC250					H05-H15		●								
	PVD DNC350					H25-H35		●								
	PVD DNC400 new					H15-H25		●								
PCD	DP90					N01-N20				●						
	DP150					N05-N25				●						
	DP200					N10-N30				●						
DIA	CVD ND2100 new					N2.5-N7.5		●		●	●		●			
	CVD ND3000 new					N01-N05		●		●	●					
DLC	PVD PD1005					N05-N10		●		●	●					
	PVD PD1010					N10-N15		●		●	●					



The comparison of grade for turning

WC

ISO	KORLOY	SUMITOMO	KYOCERA	ISCAR	SANDVIK	SECO	KENAMETAL	TOSHIBA	mitsubishi	HITACHI	VALENITE	WALTER	TAEGUTEC	NTK	DIJET
Turning	P	ST10	ST10			S1P		TX10S	ST110T	SRN5	S1F		P10		
		ST20	ST20			SM30		TX20	ST120T	WS20B			P20		
		ST30A	ST30A	PW30	IC50M	S30T	TTX	K45	TX30	UTi20T	EX35	VC6		P30	
		ST40E	IC54	S6	TTR	K420	TX40			EX40	VC5		P40		
		EX45								EX45	VC56				
Turning	M	U20	U10E			H13A	AT10	TU10	UTi20T	WAM10B	VC27		M10		
		U20	U20			H10F	AT15	TU20	TU20	EX35	VC28		M20		
		ST30A	A40				TTR	TU40					M40		
		A40													
Turning	K	H01	H1		IC4	H1P	THM	TH03	HTi10T	WH05	VC3		K10		
		H05			IC20	H10F	THR	K8735	TH10	HTi20T	W10	VC2		K20	
		G10	G10	KW10H	IC28				KS20		WH20	VC1		K20M	
													K30		

CVD coated

ISO	KORLOY	SUMITOMO	KYOCERA	ISCAR	SANDVIK	SECO	KENAMETAL	TOSHIBA	mitsubishi	HITACHI	VALENITE	WALTER	TAEGUTEC	NTK	DIJET	
Turning	P	AC805P	CA5505		GC4305	TP0500	KCP05	T9105	UE6105				TT8105			
		CA510	CA510		GC4205	TP0501	KCP05B						TT8110			
		AC810P	CA515	IC8150	GC4315	TP1500	KCP10	T9115	UE6110	HG8010	VP5515	WPP10S	TT8115			
		AC700G	VP5115		GC4215	TGP25	KCP10B		MY5015			WKP13S	LC215P			
		AC900G	CA5515										TT8115			
		AC820P	CA525	IC8250	GC4325	TP2500	KCP25	T9125	MC6025	HG8025	VP5525	WPP20S	TT8120	CP5	JC110V	
	AC2000	VP5125		GC4225	TP2501	KCP25B		UE6020			WKP23S	LC225P		JC215V		
	AC8025P	CA5525			TGP3501							TT8125				
	NC3030	AC830P	CR9025	IC8350	GC4335	TP3500	KCP30	T9135	MC6035	GM8035	VP5535	WPP30S	TT5100		JC325V	
	CA5535		CA530		GC4235	TGP45	KCP30B		UE6035		WKP33S	TT8135		JC450		
		CA530				KCP40					TT7100					
		CA530				KCP40B		UH6400								
Turning	M	NC9115★	AC610M	CA6515	IC6015	S05F	KCM15	T6120	MC7015		VP8515	WAM10	TT9215			
		NC9125★			IC6025	GC2015	TM2000	KCM15M		MC7025	GM25	VP8525	WMP20S	TT9225		
		NC9135★	AC630M	CA6525		GC2220	TM4000	KCM25	T6130	US7020	GX30	VP8525	WAM20	TT9235		
		AC6030M			GC2025		KCM35				WAM30					
		AC6030M					KCM35B									
		CA6525					KCM35B									
Turning	K	NC6310★	AC405K	CA4505	IC5005	GC3205	TK1001	KCK05	T5105	MC5005	HG3505	VP1505	WKK10S	CP2	JC105V	
		NC6315	AC415K	CA4010		GC3210	TK2001	KCK15	T5115	MC5015	HG3515	VP1510	WKK20S	CP5	JC110V	
			CA4515	CA4115	IC5015	GC3215	TKG1500	KCK15B		UC5115		VP1515	WKK20S		JC215V	
		CA4115			GC3225		KCK20	T5125			WAK30	TT7025				
		CA4120					KCK20B									

PVD coated

ISO	KORLOY	SUMITOMO	KYOCERA	ISCAR	SANDVIK	SECO	KENAMETAL	TOSHIBA	mitsubishi	HITACHI	VALENITE	WALTER	TAEGUTEC	NTK	DIJET
Turning	P	PC8105★		PR1005	IC507		CP200	AH710			VC907				
		PC8110		PR915	IC808		CP250	GH730			VC927				JC5003
		PC8115★		PR1115	IC830	GC1025	CP500	AH330	VP15TF	IP2000	VC905	WTA43			JC5015
		PC3035		PR930	IC908			AH740	VP20MF	IP3000		WTA41	TT5030		
		PC5300		PR1025	IC3028	GC4125		AH120							
			PR630	IC330			GH330								
			PR660	IC830											
			IC330												
			IC330												
			IC330												
Turning	M	PC8105★	AC510U	PR915	IC808	GC1005	CP200	AH330	MP9005	IP50S	VC929	WSM10S		ZM3	JC5003
		PC8110	EH510Z	PR930	IC907	GC1105	CP250	GH330	VP10RT	IP100S	VC927	WSM20S		QM3	JC5003
		PC8120★	AC520U		IC3028	GC1020	CP500	AH120	VP15TF		VC902	WSM30S		VM1	JC5015
		AC530U	IC830	GC1025		CP500	AH140	VP20MF		VC901	WSM40S	TT5030	TAS	JC5015	
		AC530U		GC4125			AH630			VC905					
		PR1125													
		PR630													
		PR660													
		IC330													
Turning	K	PC5300	EH510Z		IC5100		CP200	AH110		CY110H	VC929		TT5030		
			EH520Z		IC810		CP250	GH110			VC903				
					IC220		CP500	AH120			VC927				
			IC908							VC902					
			IC228							VC901					
			IC228							VC907					
Turning	S	PC8105	AC510U	PR915	IC808	GC1105	TS2000	AH110	VP05RT			WSM10	TT5030		
		PC8110	AC520U	PR660	IC3028	GC1025	CP500	AH120	VP10RT			WSM20			
		PC8120★		PR1325	IC328	GC2035	TS2500	KS5025	VP15TF			WSM30			
								MP7035							

CERMET

ISO	KORLOY	SUMITOMO	KYOCERA	ISCAR	SANDVIK	SECO	KENAMETAL	TOSHIBA	mitsubishi	HITACHI	VALENITE	WALTER	TAEGUTEC	NTK	DIJET	
Turning	P	CN1500★	T110A	PV30★		CM	HT2	NS520	NX2525	CH350			PV3010★	T3N	LN10	
		CN1500★	T2000Z★	TN30	IC20N	CT5015	C15M	KT125	GT530★	NX3035	CZ25★			CT3000	T15	CX50
		CN2500★	T1500A		IC520N	CT525	TP1020	HT5	NS530	UP35N★	CH530	VC83	WTA43★		N20	CX75
		T3000Z★	PV7020★	IC30N	GC1525★	TP1030★	KT175	NS9530	AP25N★	CH550		WTA41★		C30	CX90	
			TN60	IC530N			KT195M	GT9530★	NX335	CH570				N40	CX99	
			TN620					NS540	MP3025★							
			TN6020					NS730								
			TN90													
			PV90★													
Turning	K	CN1500★	T110A						NX2525				CT3000	T15	LN10	
		CN2500★													CX75	

★ : PVD Coating cermet ★ : New Grade



The comparison of grade for milling

CVD coated

ISO	KORLOY	SUMITOMO	KYOCERA	ISCAR	SANDVIK	SECO	KENAMETAL	TOSHIBA	mitsubishi	HITACHI	VALENITE	WALTER	TAEGUTEC	NTK	DIJET
Milling	P NC5330 NCM325 NCM535★ NCM335 NCM545★	ACP100		IC5100	GC4210	MP1500 MS2500	KCPM20		FH7020			WKP25S			
				IC5400	GC4220 GC4230	MP2500 MS2500 T350M MM4500	KCMP30 KC927M	T3130	F7030		SM245	WKP25S WKP35S WKP35G	TT8525 TT7800		
	M NC5330 NC5340★ NC5350★	ACP400				MP2500 MS2500 MM4500		T3130	F7030						
K NC5330 NCM535★ NCM545★	ACK200			IC5100		MK1500 MK2000 MS2500 T350M MK3000	KC907M KCK15 KC914M KCPK30 KC917M KC924M	T1115 T1015	MC5020		WAK15 WKK25 WKP25S WKP35S WKP35G	TT7515 TT6800			

PVD coated

ISO	KORLOY	SUMITOMO	KYOCERA	ISCAR	SANDVIK	SECO	KENAMETAL	TOSHIBA	mitsubishi	HITACHI	VALENITE	WALTER	TAEGUTEC	NTK	DIJET	
Milling	P PC2005★ PC2010★ PC2015★ PC2505★ PC2510★ PC3600 PC3700★				P20A					ATH80D PCA08M ACS05E PCA12M PC20M JX1005 TB6005 JX1020 CY9020			TT2510		DH102	
		ACZ310		IC903 IC908 IC950		MP3000	KC522M KUC20M	GH330	MP6120	TB6045	VC935	WKP25		TT7070 TT7080 TT7030		JC5003 JC5015
		ACP200	PR730		GC1025 GC1030	F25M F30M			VP15TF							
		PC210F	ACZ330	PR830 PR630	IC1008			KC525M KUC30M	AH120	UP20M	CY250 PTH30E				QM3 ZM3	JC5030 JC5040
		PC5300	ACP300 ACZ350	PR660	IC928	GC1030	F40M T60M	KC935M KC7140 KC720	AH3135	VP30RT	JM4160 PTH40H		WKP35 WKP45	TT8020		
	M PC210F PC5300 PC9530 PC5400★ PC9540★	ACM100 ACP200	PR730	IC903				KC5510 KC7020	AH120		JX1020 CY9020 JX1015 TB6020 CY250				QM3 ZM3	JC5003 JC5015
		ACM300 ACP300 ACZ350	PR1025 PR630 PR660 PR1535	IC900 IC250 IC928	GC1125 GC1025 GC2030 GC1030	F25M F30M	KC522M KC725M KC735M KC7030		MP7130	JX1045 TB6045	VC928 VC902 VC901	WQM35 WSM35S WSP45 WSM45S	TT9080 TT8020		JC5030 JC5040	
		PC6510	PR510 PR905	DT7150 IC900 IC910 IC950 IC350		MK2050	KC510M KC915M		VP10MF VP15TF		VC903 VC928		TT6290		JC5003	
	S PC5300 PC5400★ PC9540★	AC520U	PR620 PR660 PR1535	IC328 IC408	GC1025 GC1040 S40T	F40M MS2050	KC510M KCU30M		VP15TF VP30RT MP9130	ACS05E		WSM35S WSM45S	TT9030 TT8020 TT8080		JC5015	

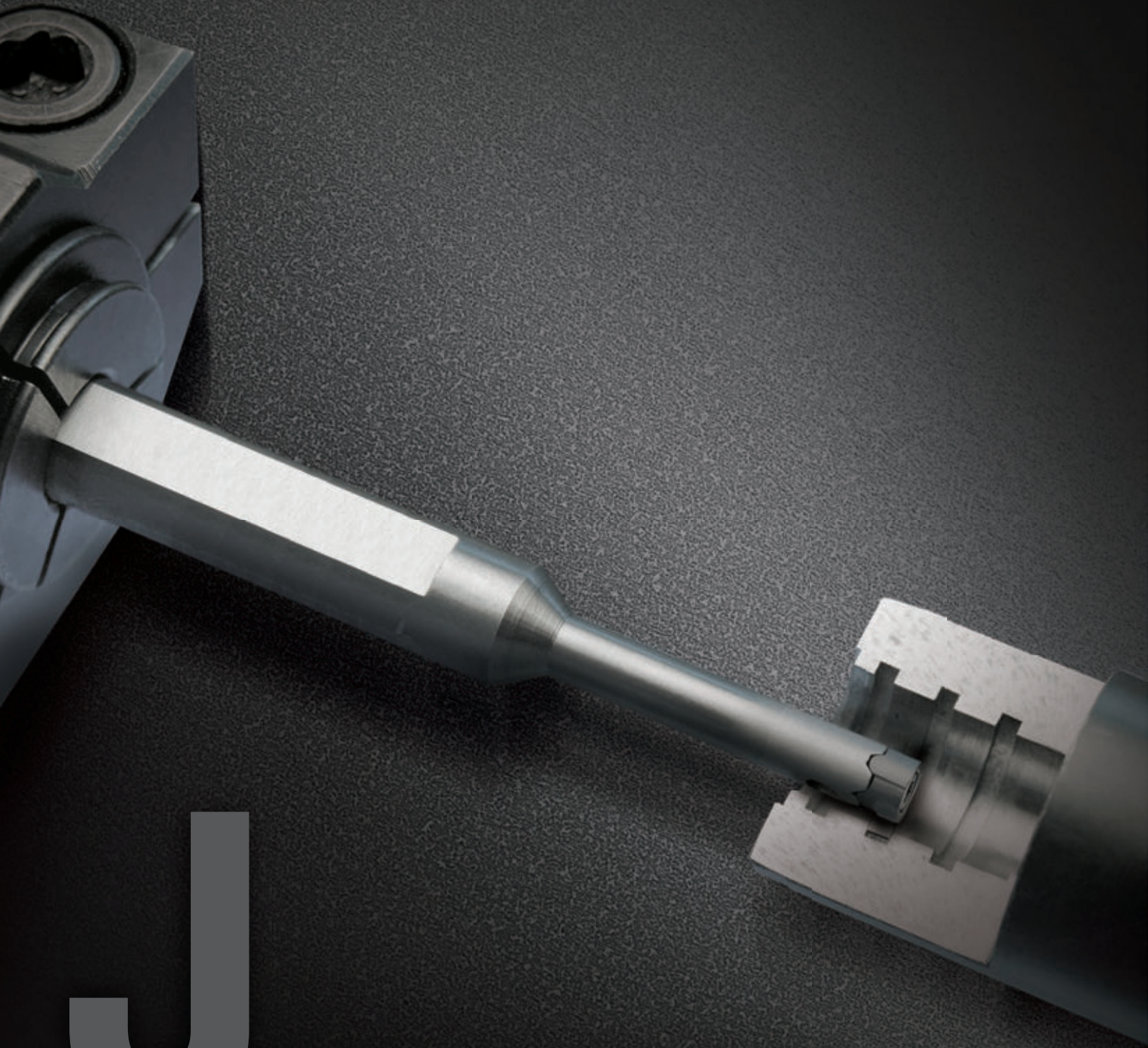
CERMET

ISO	KORLOY	SUMITOMO	KYOCERA	ISCAR	SANDVIK	SECO	KENAMETAL	TOSHIBA	mitsubishi	HITACHI	VALENITE	WALTER	TAEGUTEC	NTK	DIJET
Milling	P CN2000 CN30	T250A	TN100M TC60M	IC30N			KT195M	NS540 NS740	NX2525 NX4545	CH550 CH570			CT3000 CT7000	C50	
		T250A				CT530									
	K								NX2525						

★ : PVD Coating cermet ★ : New Grade



OLD-FASHIONED PRODUCT INFORMATION



Old-fashioned product information

- J02** Grade
- J02** External Holder
- J02** Fine Tool
- J03** Threading Tool
- J03** Mill-Max
- J04** Cen-Mill
- J04** Jip Drill
- J04** LPD/SPD/NPD

Grade

ISO material code		Old grade	New grade
Coating grade	P	NC5340	NCM535
		NCM325	
		NCM335	NCM545
		NC5350	
	PC3530, PC3525, PC3535, PC3500, PC3600		PC3700
	K	NC6215	NC6315
		NC6110, NC6210, NC6205	NC6310
	S	PC8010	PC8110
P, M, K, S	PC8520, PC215K	PC5300	
	PC225F	PC205F	
Cermet	CN1000	CN1500	
	CT10, CN200	CN2500	

- KORLOY always study and develops cutting-edge technology tools and grades which covers higher speed and feed conditions
- KORLOY guarantees better performance and wide stock-management range for the new grade

External holder

Designation	Insert	Old parts name				New holder	Page
		Wedge clamp	Screw	Washer	Others		
WTENN□□□□-□16 (Old Type: MTEEN)	TN**1604	CMH5R1	MHX0523	WA4	Same as before	WTEEN□□□□-□16	B179
WTJNR□□□□-□16 (Old Type: MTJNR)	TN**1604	CMH5R1	MHX0523	WA4	Same as before	WTJNR□□□□-□16	B179
WTXNR□□□□-□16 (Old Type: MTXNR)	TN**1604	CMH5R1	MHX0523	WA4	Same as before	WTXNR□□□□-□16	B179

- Old parts are not interchangeable with new type holder part
- Good performance and convenient use of New type holder gives customer best quality of service

Fine tool

Designation	Insert		Old parts name		New holder	Page
			Screw	Wrench		
FTIH	FTIH08****	FTG08, FTT08, FTF08	PTKA02508	TW08P	NFTIH	C69
	FTIH11****	FTG11, FTT11, FTF11	PTKA03510	TW15P		
	FTIH14****	FTG14, FTT14, FTF14	PTKA0412	TW15P		
	FTIH16****	FTG16, FTT16, FTF16	PTKA0512	TW20P		

- Old inserts and parts are not interchangeable with new fine tool
- Good performance and convenient use of new fine tool gives customer best quality of service



Threading tool

Designation	Insert		Old parts name						New holder	Page
			Clamp	Clamp screw	Shim	Screw	C-ring	Wrench		
ETH	~ETH3**R	ECTR3***	CH5R3	CHX0513	ST32C1	SHX0310	CR04	HW20L, HW25L	ER(L)H-*	D31
	~ETH4**R	ECTR4***	CH6R4	CHX0621	ST42C1	SHX0310	CR05	HW20L, HW30L		
ITH	~ITH2**R	ICTR2***	CH5R3	CHX0513	ST32C1	FTKA02565	CR04	TW07P	IR(L)H-*	D32
	~ITH3**R	ICTR3***	CH5R3	CHX0513	ST32C1	SHX0310	CR04	TW15P, HW20L, HW25L		
	~ITH4**R	ICTR4***	CH6R4	CHX0621	ST42C1	SHX0310	CR05	HW20L, HW30L		

- Old inserts and parts are not interchangeable with threading holders
- Good performance and convenient use of new fine tool gives customer best quality of service

Mill-Max

Designation	Insert	Old parts name					New holder	Page
		Locator	Wedge	Wedge screw	Locator screw	Wrench		
AD(ADM)4000	SD**1203	LAS4R/L	WASR/L	WTX0817	LTX0512	TW25	ADN(ADNM)4000	E47
AD(ADM)5000	SD**1504	LAS5R/L	WASR/L	WTX0817	LTX0512	TW25	ADN(ADNM)5000+	E48
ADN(ADNM)5000	SD**1504	LADN5R/L	WEPN5R/L	DHA0821F	LTX0514	HW40		
EP(EPM)4000	SP**1203	LES4R/L LES4R1/L1 (Ø80 ~ Ø100)	WESR/L	WTX0817 WTX0813 (Ø80 ~ Ø100)	LTX0512	TW25	EPN(EPNM)4000	E53
EP(EPM)5000	SP**1504	LES5R/L LES5R1/L1 (Ø80 ~ Ø100)	WESR/L	WTX0817 WTX0813 (Ø80 ~ Ø100)	LTX0512	TW25	EPN(EPNM)5000+	E54
EPN(EPNM)5000	SP**1504	LEPN5R/L LEPN5R1/L1 (Ø80 ~ Ø100)	WEPN5R/L	DHA0821F DHA0817F (Ø80 ~ Ø100)	LTX0514	HW40		
PP(PPM)4000	TP**2204	LPT4R/L LPT4R1/L1 (Ø80 ~ Ø100)	WESR/L	WTX0817 WTX0813 (Ø80 ~ Ø100)	LTX0512	TW25	PPN(PPNM)4000	E56

- Parts are not interchangeable with new mill-max cutters
- Good performance and convenient use of new mill-max gives customer best quality of service

➤ Cen-Mill

Designation	Insert		Old parts name		New product	Page
			Screw	Wrench		
HE	Ø25	MCMT080308EN ZCMT080308ER	FTNA0307	TW09P	AMS****M	E185~E187
	Ø32, 40, 50	MCMT09T308EN ZCMT09T308ER	FTNA0408	TW15P		
LE (LEM)	LOCX1205ZZ		FTNB0411	TW15S	AMC****M	E172~E174
SE	Ø25	MPMT090308	FTNA0408	TW15S	AMS****MH	E188~E189
	Ø32, 40	MPMT120408	FTNA0513	TW20S		
TM	MIT100,150,200,300,400 MET100,150,200,300,400		FTNB0411(TM632R) FTNA0513	TW15L(TM632R) TW20L	TMS(I)	D49
PM	EDCW1604ZDF/TR		FTNA0513	TW20L	RM4Z	E118~E119
CE (Code changed)	SPG(M)N1203**				CE45-****R-S32 (New code)	E369~E371

- Old inserts and parts are not interchangeable with new milling product
- New product : Alpha mill which has unique alpha-curve edge guarantees wide range machining and good performance.
- Good performance and convenient use of new milling tool gives customer best quality of service

➤ Jip Drill

Designation	Insert		Old parts name		New product	Page
			Screw	Wrench		
JD	~ JD200	WCMT030208-C20	FTNA02565	TW07P	K□D (KING-DRILL)	F11~F25
	~ JD250	WCMT040208-C20				
	~ JD300	WCMT050308-C20	FTNA0307	TW09P		
	~ JD410	WCMT06T308-C20	FTGA03508			
	~ JD580	WCMT080408-C20	FTNA0408	TW15P		

- Old inserts and parts are not interchangeable with new indexable drill
- Good performance and convenient use of new indexable drill gives customer best quality of service

➤ LPD/SPD/NPD

Designation	Insert		Old parts name		New product	Page
			Screw	Wrench		
LPD	~ LPD135	LPMT040203-DF	FTNA0204	TW06P	K□D (KING-DRILL)	F11~F25
SPD	~ SPD155	SPM(E)T050203-DM, DF, DS, DA	FTNA0204	TW06P		
	~ SPD195	SPM(E)T060204-DM, DS, DR, DA	FTKA02206S	TW07S		
	~ SPD225	SPM(E)T070204-DM, DS, DR, DA	FTKA02565	TW07S		
NPD	~ NPD245	NPM(E)T222408-DM, DS, DR, DA	FTKA02565	TW07S		
	~ NPD285	NPM(E)T252808-DM, DS, DR, DA	FTKA0307	TW09S		
	~ NPD325	NPM(E)T293208-DM, DS, DR, DA	FTKA0307	TW09S		
	~ NPD405	NPM(E)T334008-DM, DS, DR, DA	FTKA03508	TW15S		
	~ NPD505	NPM(E)T415008-DM, DS, DR, DA	FTKA0410	TW15S		
	~ NPD605	NPM(E)T516012-DM, DS, DR, DA	FTNC04511	TW20S		

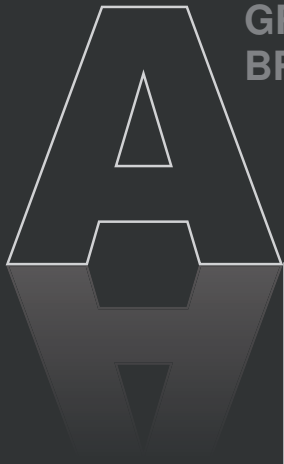
- Old inserts and parts are not interchangeable with new indexable drill
- Good performance and convenient use of new indexable drill gives customer best quality of service





INDEX

GRADES & CHIP
BREAKERS



MULTI
FUNCTIONAL
TOOLS

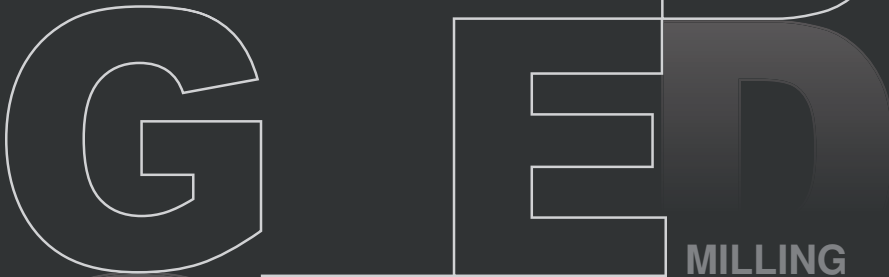


TURNING



THREADING

TOOLING
SYSTEM



MILLING

PARTS



DRILL

TECHNICAL
INFORMATION

OLD-FASHIONED
PRODUCT
INFORMATION



INDEX

K02 Index by items

K07 Index by designation

K Index by items

A

Actual Designations of Milling Cutter and Arbor	Milling	E426
Aero Mill	Milling	E151
Aero Mill Mini	Milling	E154
Aero Mill Plus	Milling	E152
Alpha Mill	Milling	E164
Alpha Mill-X		E197
Alpha Mill-X	Milling	E145
Aluminum Insert (Positive)	Turning	B102
American ACME	Threading	D24
American Buttress (ABUT)	Threading	D28
American UN	Threading	D16
Angular Head		G86
API Buttress Casing (BUT)	Threading	D30
API Round Casing & Tubing (APIRD)	Threading	D30
Application Example	Multi functional Tools	C02
Application range of KORLOY Main Chip Breakers	Turning	B02
Auto Tools (Blade Type)	Turning	B136
Auto Tools (ISO Type)	Turning	B122
Auto Tools (KGT/MGT Type)	Turning	B142
Auto Tools (MSB Tool)	Turning	B145
Auto Tools (Multi Utility Type)	Turning	B139
Available Insert	Drills	F03
Available Insert for Fine Tools	Multi functional Tools	C68
Available Insert for K Notch	Multi functional Tools	C57
Available Insert for KGT	Multi functional Tools	C12
Available Insert for MGT	Multi functional Tools	C28
Available Insert for MGT Aluminum Wheel	Multi functional Tools	C44
Available Insert for TB/TB-M	Multi functional Tools	C51
Available Insert for TB/TB-M	Multi functional Tools	C50

B

Bearing Solution	Turning	B156
BFE	Milling	E331
Boring Bar Code System (ISO)	Turning	B204
BRE	Milling	E335
British Buttress (BBUT)	Threading	D28
British Standard Pipe Thread	Threading	D22
BT Tooling System (Alpha Mill)	Milling	E342
BT Tooling System (Mono-Tool)	Milling	E347

C

Cartridge		H03
Cartridge Code System (ISO)	Turning	B241

C

cBN inserts grades	Grades & Chip Breakers	A31
cBN Insert	Turning	B110
Cen-Mill	Old-Fashioned Product Information	J04
Center Drill	Drills	F78
Ceramic Holder	Turning	B197
Cermet grades (Milling)	Grades & Chip Breakers	A24
Cermet grades (Turning)	Grades & Chip Breakers	A13
Chamfer Tool	Milling	E366
Chip breaker		H03
Chip breaker for drilling	Grades & Chip Breakers	A49
Chip breaker for milling	Grades & Chip Breakers	A42
Chip breaker for turning	Grades & Chip Breakers	A37
Chip Cover	Parts	H03
Clamp	Parts	H03
Clamp On System (Boring Bar)	Turning	B212
Clamp On System (Cartridge)	Turning	B243
Clamp On System (Holder)	Turning	B181
Coated cermet grades (Turning)	Grades & Chip Breakers	A15
Collet Chuck Series	Tooling System	G24
Compact Mini	Turning	B225
Coolant Bolt	Parts	H04
CVD coated grades (Milling)	Grades & Chip Breakers	A17
CVD coated grades (Turning)	Grades & Chip Breakers	A05

D

DAMPING PRO		G97
DBC	Tooling System	G66
DBCA	Tooling System	G62
DBH	Multi functional Tools	C70
DCJ		G95
DCL		G96
DCS/DC/TC	Tooling System	G23
DHC/DHJ Collet	Tooling System	G11
DHE	Tooling System	G07
DHE/S	Tooling System	G04
Diamond coated grades	Grades & Chip Breakers	A29
DLC coated grades	Grades & Chip Breakers	A30
Double Clamp System (Boring Bar)	Turning	B208
Double Clamp System (Holder)	Turning	B167
Double Mill	Milling	E62
DSC	Tooling System	G12
DSK	Tooling System	G30
DST	Tooling System	G41



D

DTN	Tooling System	G44
DZC		G94

E

ER	Tooling System	G36
ER/L	Tooling System	G37
EXT Bar	Tooling System	G54
External Holder	Threading	D31
External Holder	Old-Fashioned Product Information	J02
External Tool Holder Code System (ISO)	Turning	B162
Extreme Line Casing (EL)	Threading	D30

F

FBC	Tooling System	G82
FBH/B	Tooling System	G55
Feature of Chip Breakers	Turning	B16
Fine Tool	Old-Fashioned Product Information	J03
Fine Tools Holder	Multi functional Tools	C69
FMA	Tooling System	G49
FMC	Tooling System	G50
FMR P-positive	Milling	E242
Future Mill	Milling	E216

G

GBE	Milling	G82
Gear Cutter	Milling	G55
Gear Cutter Order Form	Milling	B16
Gear Cutter Table	Milling	J03
GERC	Tooling System	C69
GFIP	Multi functional Tools	G49
Grade	Old-Fashioned Product Information	G50
Grades system	Grades & Chip Breakers	E242
GSK	Tooling System	E216

H

Hardness calculating table		I 08
HAVE (Single edge/Multi edge)	Milling	E339
HFM	Milling	E281
HFMD		E267
HFMD	Milling	E264
HRM	Milling	E300

H

HRMDouble	Milling	E289
HSK Tooling System	Turning	B231
HSK Tooling System (Alpha Mill)	Milling	E353
HSK Tooling System (Mono-Tool)	Milling	E358
HSK Tooling System (Pro-V Mill)	Milling	E363

I**J**

IGH	Multi functional Tools	C70
Index for Boring Bar	Turning	B205
Index for Cartridge	Turning	B242
Index for External Holder	Turning	B163
Index for HSK Tooling System	Turning	B230
Index for KM Tooling System	Turning	B230
Indexable HOB	Milling	E440
Indexable HOB Order Form	Milling	E441
Indexable Reamer		F86
Instruction of Boring Bar assembly	Turning	B207
Instruction of External Holder	Turning	B166
Internal Holder	Threading	D32
ISO Metric	Threading	D12
Jip Drill	Old-Fashioned Product Information	J04

K

K Notch Holder	Multi functional Tools	C59
KED Plus Drill	Drills	F29
KGT Blade for Parting off	Multi functional Tools	C25
KGT Cartridge	Multi functional Tools	C41
KGT Holder	Multi functional Tools	C15
KGT/MGT Cartridge Holder	Multi functional Tools	C40
KHP Coolant	Turning	B127
KHP Coolant	Turning	B202
KING DRILL	Drills	F11
KING DRILL for large diameter drilling	Drills	F25
KING DRILL for through coolant system with a lathe	Drills	F21
KM Tooling System	Turning	B237
KMB	Tooling System	G70
KORLOY Cutters	Milling	E34
KORLOY Grades	Technical Information	I 37
KORLOY Modular Adaptors	Milling	E45
KORLOY Shanks	Milling	E42
KRLOY Drills	Drills	F02

K Index by items

L

Laser Mill	Milling	E326
Lever	Parts	H04
Lever Lock System (Boring Bar)	Turning	B210
Lever Lock System (Holder)	Turning	B172
Locator	Parts	H05
LPD/SPD/NPD	Old-Fashioned Product Information	J04

M

MD	Tooling System	G52
Metric Buttress (SAGE)/API	Threading	D29
MGT Aluminum Wheel	Multi functional Tools	C45
MGT Cartridge	Multi functional Tools	C42
MGT Holder	Multi functional Tools	C31
MGT Holder (Face Grooving)	Multi functional Tools	C36
MGT Special Order Form for MGT	Multi functional Tools	C72
Milling grade selections	Grades & Chip Breakers	A16
Milling Insert Code System (ISO)	Milling	E02
Milling Inserts	Milling	E04
Mill-max	Milling	E47
Mill-Max	Old-Fashioned Product Information	J03
Mill-max Heavy	Milling	E58
Mill-max Plus	Milling	E48, 54
Modular Adaptor	Milling	E401
Multi Lock System (Boring Bar)	Turning	B213
Multi Lock System (Holder)	Turning	B183
Multi Turn	Turning	B154

N O

National Pipe Thread	Threading	D22
National Pipe Thread-Dry seal	Threading	D23
Nozzle	Parts	H07
NPM	Tooling System	G20
NPU	Tooling System	G40
Nut	Parts	H05
O-Ring Cutter	Milling	E364
Others	Tooling System	G104

P

Partial Profile 55°	Threading	D11
Partial Profile 60°	Threading	D10
PCD Face Cutter	Milling	E156
PCD inserts grades	Grades & Chip Breakers	A36

P

PCD Insert	Turning	B113
Pin	Parts	H05
Power Buster	Milling	E68
Pro-A Mill	Milling	E385
Pro-L Mill	Milling	E394
Properties of Korloy grades	Technical Information	I 09
Pro-V Mill		E399
Pro-V Mill	Milling	E368
Pro-X Mill	Milling	E388
Pro-XL Mill	Milling	E398
PVD coated grades (Milling)	Grades & Chip Breakers	A18
PVD coated grades (Turning)	Grades & Chip Breakers	A10

R

RDC Bar	Tooling System	G54
Recommended Chip Breakers for workpiece	Turning	B04
Rich Mill	Milling	E99
Round DIN 405	Threading	D23
RTJW	Tooling System	G38

S

SAH		G85
Save Turn Boring Bar	Turning	B119
Save Turn Holder	Turning	B116
Save Turn Insert	Turning	B115
Saw man	Multi functional Tools	C61
Saw man-X	Multi functional Tools	C65
Screw	Parts	H05
Screw On System (Boring Bar)	Turning	B215
Screw On System (Cartridge)	Turning	B245
Screw On System (Holder)	Turning	B190
SDC/P	Tooling System	G25
Shim		H02
Shim Pin	Parts	H06
SI unit conversion table	Technical Information	I 07
Side Cutter	Milling	E411
Side Milling Cutter	Milling	E407
SLA	Tooling System	G47
Sleeve	Turning	B151
SMB	Tooling System	G68
SMH	Tooling System	G72
Solid drills grade selections	Grades & Chip Breakers	A27
Solid drills grades	Grades & Chip Breakers	A28



S

Solid endmills grade selections	Grades & Chip Breakers	A25
Solid endmills grades	Grades & Chip Breakers	A26
Special Order Form for Bearing Inserts	Turning	B161
Special Order Form for V-Pulley Insert	Multi functional Tools	C73
Spring	Parts	H07
Steel, Non-ferrous metal symbol list	Technical Information	I 06
Stop Ring	Parts	H07
Stopper	Parts	H07
Stub ACME	Threading	D25

T

Tank Mill	Milling	E307
TBC	Tooling System	G79
TBCA	Tooling System	G74
TB-M/TB Holder	Multi functional Tools	C54
TCA Tap Adaptor	Tooling System	G46
T-Cutter	Milling	E374
Technical Information for Aero Mill	Milling	E147
Technical Information for Aero Mill Mini	Milling	E150
Technical Information for Aero Mill Plus	Milling	E149
Technical Information for Alpha Mill	Milling	E157
Technical Information for Alpha Mill Nick		E158
Technical Information for Alpha Mill-X		E193
Technical Information for Alpha Mill-X	Milling	E142
Technical Information for Auto Tools	Turning	B121
Technical Information for Bearing Solution	Turning	B155
Technical Information for BRE	Milling	E325
Technical Information for BT/HSK Tooling System	Milling	E341
Technical Information for Couple Mill	Milling	E421
Technical Information for Cube Mill	Milling	E420
Technical Information for Drills	Technical Information	I 30
Technical Information for Endmills	Technical Information	I 27
Technical Information for Fine Tools	Multi functional Tools	C67
Technical Information for FMR P-positive	Milling	E211
Technical Information for Future Mill	Milling	E201
Technical Information for GBE	Milling	E322
Technical Information for Gear Cutter Tools	Milling	E429
Technical Information for HAVE	Milling	E337
Technical Information for HFM	Milling	E277
Technical Information for HFMD		E262
Technical Information for HFMD	Milling	E260
Technical Information for Hihg feed Cutter	Milling	E418
Technical Information for HRMDouble	Milling	E284
Technical Information for HSK Tooling System	Turning	B228

T

Technical Information for Indexable Reamer		F82
Technical Information for K Notch	Multi functional Tools	C55
Technical Information for KED Plus Drill	Drills	F26
Technical Information for KGT	Multi functional Tools	C07
Technical Information for KGT/MGT Cartridge	Multi functional Tools	C39
Technical Information for KHP Coolant	Turning	B199
Technical Information for KING DRILL	Drills	F05
Technical Information for KING DRILL (for large diameter drilling)	Drills	F24
Technical Information for KING DRILL (for through coolant system with a lathe)	Drills	F20
Technical Information for Laser Mill	Milling	E317
Technical Information for MGT	Multi functional Tools	C26
Technical Information for MGT Aluminum Wheel	Multi functional Tools	C43
Technical Information for Milling	Technical Information	I 20
Technical Information for Mill-max Heavy	Milling	E57
Technical Information for Multi Functional Tools Series	Multi functional Tools	C04
Technical Information for Multi Turn	Turning	B152
Technical Information for Power Buster	Milling	E64
Technical Information for Pro-A Mill	Milling	E375
Technical Information for Pro-L Mill	Milling	E379
Technical Information for Pro-L Mill		E382
Technical Information for Pro-V Mill	Milling	E351
Technical Information for Pro-X Mill	Milling	E377
Technical Information for Pro-XL Mill	Milling	E381
Technical Information for Rich Mill	Milling	E71
Technical Information for Save Turn	Turning	B114
Technical Information for Saw man	Multi functional Tools	C60
Technical Information for Saw man-X	Multi functional Tools	C63
Technical Information for Shave Mill	Milling	E423
Technical Information for Shave Mill Ultra	Milling	E425
Technical Information for Side Milling Cutters	Milling	E405
Technical Information for Tapers	Technical Information	I 24
Technical Information for TB/TB-M	Multi functional Tools	C47
Technical Information for Thread Milling	Threading	D34
Technical Information for Threading	Threading	D03
Technical Information for TP2P	Milling	E308
Technical Information for TPDB Plus Drill	Drills	F54
Technical Information for TPDB-F		F63
Technical Information for TPDB-H	Drills	F68
Technical Information for TPDC Plus Drill	Drills	F37
Technical Information for Triple Mill		E254
Technical Information for Turning	Technical Information	I 10
Technical Information for Wind Mill	Milling	E414
Technical Information for WPDC	Drills	F75
Technical Information KM Tooling System	Turning	B229
TER Tap Collet	Tooling System	G43

K Index by items

T

The Comparison of Grade for Milling	Technical Information	I 41
The Comparison of Grade for Turning	Technical Information	I 40
The Comparison of Chip Breakers	Technical Information	I 36
Thread Milling Holder	Threading	D49
Thread Milling Inserts	Threading	D44
Threading Holder Code System	Threading	D02
Threading Insert Code System	Threading	D02
Threading Insert with Chip Breaker	Threading	D09
Threading Tool	Old-Fashioned Product Information	J03
Tooling System Index	Tooling System	G02
TP2P	Milling	E311
TPDB Plus Drill	Drills	F57
TPDB-F		F66
TPDB-H	Drills	F71
TPDC Plus Drill	Drills	F47
Trapez DIN 103	Threading	D24
Triple Mill		E258
Turbo Mill	Milling	E59
Turning grade selections	Grades & Chip Breakers	A04
Turning Insert (Negative)	Turning	B36
Turning Insert (Positive)	Turning	B73
Turning Insert Code System (ISO)	Turning	B34

U

Uncoated carbide grades (Milling)	Grades & Chip Breakers	A23
Uncoated carbide grades (Turning)	Grades & Chip Breakers	A12
UNJ (Unified Constant Thread)	Threading	D26

V

Vertical Type Holder	Threading	D33
-----------------------------	-----------	-----

W

Washer	Parts	H07
Wedge Clamp System(Holder)	Turning	B179
Wind Mill	Milling	E416
With Worth	Threading	D18
Workpiece material grades	Technical Information	I 02
WPDC	Drills	F79
Wrench	Parts	H07
Wrench Bolt	Parts	H04



A

ADKA	Milling insert (Indexable Endmill)	E04
ADKT-ML	Milling insert (Alpha Mill-X)	E04
ADKT-MM	Milling insert (Alpha Mill-X)	E04
ADLT	Milling insert (Tank Mill)	E04
ADN(M)4000	Mill-max	E47
ADN(M)5000+	Mill-max Plus	E48
ADS4000	Turbo Mill	E59
ADS5000	Turbo Mill	E60
AE(M)4000	Mill-max	E49
AE(M)5000	Mill-max	E50
AFO(M)4000	Double Mill	E62
AFO(M)5000	Double Mill	E63
AMC(M)1000S	Alpha Mill	E164
AMC(M)1000SE	Alpha Mill	E170
AMC(M)1500S	Alpha Mill	E165
AMC(M)2000M	Alpha Mill	E172
AMC(M)2000S	Alpha Mill	E166
AMC(M)2000SE	Alpha Mill	E170
AMC(M)3000M	Alpha Mill	E173
AMC(M)3000S	Alpha Mill	E167
AMC(M)3000SE	Alpha Mill	E171
AMC(M)3000S-K	Alpha Mill	E168
AMC(M)4000M	Alpha Mill	E174
AMC(M)4000S	Alpha Mill	E169
AMM1000	Alpha Mill	E190
AMM1500	Alpha Mill	E191
AMM2000	Alpha Mill	E192
AMS1000M	Alpha Mill	E185
AMS1000MH	Alpha Mill	E188
AMS1000S	Alpha Mill	E175
AMS1000SE	Alpha Mill	E183
AMS1500M	Alpha Mill	E185
AMS1500MH	Alpha Mill	E188
AMS1500S	Alpha Mill	E176
AMS2000M	Alpha Mill	E186
AMS2000MH	Alpha Mill	E189
AMS2000S	Alpha Mill	E178
AMS2000SE	Alpha Mill	E183
AMS3000MH(-K)	Alpha Mill	E189
AMS3000S	Alpha Mill	E179
AMS3000SE	Alpha Mill	E184
AMS3000S-K	Alpha Mill	E180
AMS4000M	Alpha Mill	E187
AMS4000S	Alpha Mill	E181
AMXCM-AD10/12	Alpha Mill-X	E197

A

AMXCM-AD17	Alpha Mill-X	E198
AMXS-AD10/12	Alpha Mill-X	E199
AMXS-AD17	Alpha Mill-X	E200
APD(M)-A	Aero Mill	E151
APD(M)-PB	Aero Mill-Plus	E152
API	Thread Insert	D29
APKT	Milling Insert (Alpha Mill)	E04
APKT-MA	Milling Insert (Alpha Mill)	E04
APKT-MA2	Milling Insert (Alpha Mill)	E04
APKT-MA3	Milling Insert (Alpha Mill)	E04
APKT-MF	Milling Insert (Alpha Mill)	E04
APKT-MM	Milling Insert (Alpha Mill)	E04
APLT	Milling insert (Tank Mill)	E05
APMT-MA	Milling Insert (Alpha Mill)	E05
APMT-ML	Milling Insert (Alpha Mill)	E05
APMT-MM	Milling Insert (Alpha Mill)	E06
APMT-MN	Milling Insert (Alpha Mill)	E06

B

BAMPR/L-XAF	Milling Insert (Aero Mill-Plus)	E07
BAMPR/L-XAW	Milling Insert (Aero Mill-Plus)	E07
BAMPR/L-XAWR	Milling Insert (Aero Mill-Plus)	E07
BF	Multi functional Insert (Grooving Tools)	C71
BFE	BFE	E331
BRE	BRE	E335
BT30	Modular Adaptor (BT)	E403
BT30 AM1000	BT Tooling System (Mono-Tool)	E347
BT30 AM1000HS	BT Tooling System (Alpha Mill)	E342
BT30 AM1500	BT Tooling System (Mono-Tool)	E348
BT30 AM2000	BT Tooling System (Mono-Tool)	E349
BT40	Modular Adaptor (BT)	E403
BT40 AM1000	BT Tooling System (Mono-Tool)	E347
BT40 AM1500	BT Tooling System (Mono-Tool)	E348
BT40 AM1500HS	BT Tooling System (Alpha Mill)	E343
BT40 AM2000	BT Tooling System (Mono-Tool)	E349
BT40 AM2000HS	BT Tooling System (Alpha Mill)	E344
BT50	Modular Adaptor (BT)	E403
BT50 AM3000	BT Tooling System (Mono-Tool)	E350
BT50 AM3000HS	BT Tooling System (Alpha Mill)	E345
BT50 AM4000	BT Tooling System (Mono-Tool)	E351
BT50 AM4000HS	BT Tooling System (Alpha Mill)	E346
BT50 HAT4000	BT Tooling System (Mono-Tool)	E352

K Index by designation

C

CCET	Turning Insert_Positive (Carbide Shank Boring Bar)	B75
CCET-KF	Auto tools Insert (ISO type)	B130
CCET-KF	Auto tools Insert (ISO type)	B76
CCET-KM	Auto tools Insert (ISO type)	B131
CCET-KM	Auto tools Insert (ISO type)	B77
CCGT-AK	Aluminum Insert_Positive (Screw on System)	B103
CCGT-AR	Aluminum Insert_Positive (Screw on System)	B103
CCGT-FS	Auto tools Insert (ISO type)	B131
CCGT-FS	Turning Insert_Positive (Screw on System)	B74
CCGT-KF	Auto tools Insert (ISO type)	B130
CCGT-KF	Turning Insert_Positive (Screw on System)	B76
CCGT-KM	Auto tools Insert (ISO type)	B130
CCGT-KM	Turning Insert_Positive (Screw on System)	B77
CCGT-MS	Auto tools Insert (ISO type)	B131
CCGT-MS	Turning Insert_Positive (Screw on System)	B74
CCGT-VP1	Auto tools Insert (ISO type)	B131
CCGT-VP1	Turning Insert_Positive (Screw on System)	B75
CCLNR/L	Ceramic Holder	B197
CCMT	PCD Insert_Positive	B113
CCMT-C25	Turning Insert_Positive (Screw on System)	B74
CCMT-FP	Turning Insert_Positive (Screw on System)	B73
CCMT-HMP	Turning Insert_Positive (Screw on System)	B73
CCMT-MP	Turning Insert_Positive (Screw on System)	B73
CCMT-VF	Turning Insert_Positive (Screw on System)	B73
CCMT-VL	Turning Insert_Positive (Screw on System)	B73
CCMT-VP1	Turning Insert_Positive (Screw on System)	B74
CCMW	cBN Insert_Positive (Regrinding)	B112
CCMW	PCD Insert_Positive	B113
CCT	Solid Chamfer Tool	E373
CD	Drill Insert (Center Drill)	F78
CDEW-NAF	Milling Insert (Aero Mill)	E07
CDEW-NAW	Milling Insert (Aero Mill)	E07
CDEW-XAF	Milling Insert (Aero Mill)	E07
CDEW-XAW	Milling Insert (Aero Mill)	E07
CDEW-XCF	Milling Insert (Aero Mill)	E07
CDH	Drill Insert (Center Drill)	F78
CE	Chamfer Tool (Back & Front Chamfer)	E369
CE	Chamfer Tool (Long Chamfer)	E370
CE	Chamfer Tool (Multi-functional)	E371
CET	Solid Chamfer Tool	E372
CKFNR/L...RW	Bearing Solution	B159
CKGNR...RW	Bearing Solution	B159
CKJNR/L	Holder (Clamp on System)	B181
CKNNR/L	Holder (Clamp on System)	B181
CKUNR/L	Boring Bar (Clamp on System)	B212

C

CMSNR/L...B	Bearing Solution	B156
CMSNR/L...F	Bearing Solution	B156
CNGG-VP1	Turning Insert_Negative (Multi Lock/Lever Lock System)	B40
CNGG-VP3	Turning Insert_Negative (Multi Lock/Lever Lock System)	B41
CNHQ	Milling Insert (Side milling cutter_Tangential type)	E07
CNMA	cBN Insert_Negative(Regrinding)	B112
CNMA	Turning Insert_Negative (Multi Lock / Lever Lock System)	B39
CNMG-B25	Turning Insert_Negative (Multi Lock/Lever Lock System)	B38
CNMG-CP	Turning Insert_Negative (Multi Lock/Lever Lock System)	B36
CNMG-GR	Turning Insert_Negative (Multi Lock/Lever Lock System)	B38
CNMG-HA	Turning Insert_Negative (Multi Lock/Lever Lock System)	B41
CNMG-HM	Turning Insert_Negative	B37
CNMG-LP	Turning Insert_Negative (Multi Lock/Lever Lock System)	B36
CNMG-LW	Turning Insert_Negative (Multi Lock/Lever Lock System)	B42
CNMG-MK	Turning Insert_Negative (Multi Lock/Lever Lock System)	B38
CNMG-MM	Turning Insert (SAVE TURN)	B115
CNMG-MM	Turning Insert_Negative (Multi Lock/Lever Lock System)	B40
CNMG-MP	Turning Insert (SAVE TURN)	B115
CNMG-MP	Turning Insert_Negative (Multi Lock/Lever Lock System)	B37
CNMG-RK	Turning Insert_Negative (Multi Lock/Lever Lock System)	B39
CNMG-RM	Turning Insert_Negative (Multi Lock/Lever Lock System)	B40
CNMG-VB	Turning Insert_Negative (Multi Lock/Lever Lock System)	B36
CNMG-VC	Turning Insert_Negative (Multi Lock/Lever Lock System)	B36
CNMG-VF	Turning Insert_Negative (Multi Lock/Lever Lock System)	B36
CNMG-VL	Turning Insert_Negative (Multi Lock/Lever Lock System)	B36
CNMG-VM	Turning Insert_Negative (Multi Lock/Lever Lock System)	B37
CNMG-VP1	Turning Insert_Negative (Multi Lock/Lever Lock System)	B40
CNMG-VP2	Turning Insert_Negative (Multi Lock/Lever Lock System)	B41
CNMG-VP3	Turning Insert_Negative (Multi Lock/Lever Lock System)	B41
CNMG-VP4	Turning Insert_Negative (Multi Lock/Lever Lock System)	B41
CNMG-VQ	Turning Insert (SAVE TURN)	B115
CNMG-VQ	Turning Insert_Negative (Multi Lock/Lever Lock System)	B38
CNMG-VR	Turning Insert_Negative (Multi Lock/Lever Lock System)	B39
CNMG-VW	Turning Insert_Negative (Multi Lock/Lever Lock System)	B41
CNMM	PCD Insert_Negative	B113
CNMM-GH	Turning Insert_Negative (Multi Lock / Lever Lock System)	B42
CNMM-GR	Turning Insert_Negative (Lever Lock System)	B42
CNMM-VH	Turning Insert_Negative (Lever Lock System)	B42
CNMM-VT	Turning Insert_Negative (Lever Lock System)	B42
CP Chip Breaker	Turning Chip Breaker	B16
CPGT	Turning Insert_Positive (Screw on System)	B78
CPGT-HMP	Turning Insert_Positive (Screw on System)	B78
CPMH	Milling Insert (T-Cutter)	E07
CPMT	Milling Insert (T-Cutter)	E08
CPMT-C25	Turning Insert_Positive (Screw on System)	B78



C

CPMT-VF	Turning Insert_Positive (Screw on System)	B78
CPMT-VL	Turning Insert_Positive (Screw on System)	B78
CRDNN	Ceramic Holder	B197
CRGNR/L	Ceramic Holder	B197
CSBNR/L...BS	Bearing Solution	B160
CSDNN	Ceramic Holder	B197
CSDPN	Holder (Clamp on System)	B181
CSGNR/L...RW	Bearing Solution	B159
CSKNR/L	Ceramic Holder	B198
CSKNR/L...BS	Bearing Solution	B160
CSKPR/L	Holder (Clamp on System)	B182
CSKPR/L	Boring Bar (Clamp on System)	B212
CSKPR/L	Cartridge (Clamp on System)	B243
CSKPR/L...B	Bearing Solution	B158
CTFNR/L	Ceramic Holder	B198
CTFPR/L	Holder (Clamp on System)	B182
CTFPR/L	Boring Bar (Clamp on System)	B212
CTFPR/L	Cartridge (Clamp on System)	B243
CTGNR/L	Ceramic Holder	B198
CTGNR/L...BS	Bearing Solution	B160
CTGPR/L	Holder (Clamp on System)	B182
CTSPR/L	Cartridge (Clamp on System)	B244
CTTPR/L	Cartridge (Clamp on System)	B244
CTWPR/L	Cartridge (Clamp on System)	B245

D

DB	Multi functional Insert (Grooving Tools)	C70
DBH	Multi functional holder (Grooving Tools)	C70
DC	Multi functional Insert (Grooving Tools)	C70
DCBNR/L	Holder (Double clamp system)	B167
DCET-KF	Auto tools Insert (ISO type)	B132
DCET-KF	Turning Insert_Positive (Screw on System)	B81
DCET-KM	Auto tools Insert (ISO type)	B132
DCET-KM	Turning Insert_Positive (Screw on System)	B82
DCGT	PCD Insert_Positive	B113
DCGT-AK	Aluminum Insert_Positive (Screw on System)	B104
DCGT-AR	Aluminum Insert_Positive (Screw on System)	B104
DCGT-FS	Auto tools Insert (ISO type)	B132
DCGT-FS	Turning Insert_Positive (Screw on System)	B80
DCGT-KF	Auto tools Insert (ISO type)	B131
DCGT-KF	Turning Insert_Positive (Screw on System)	B81
DCGT-KM	Auto tools Insert (ISO type)	B132
DCGT-KM	Turning Insert_Positive (Screw on System)	B82
DCGT-MS	Auto tools Insert (ISO type)	B132

D

DCGT-MS	Turning Insert_Positive (Screw on System)	B80
DCGT-VP1	Auto tools Insert (ISO type)	B133
DCGT-VP1	Turning Insert_Positive (Screw on System)	B81
DCGW	cBN Insert_Positive (Regrinding)	B112
DCKNR/L	Holder (Double clamp system)	B167
DCLNR/L	Holder (Double clamp system)	B167
DCLNR/L	Boring Bar (Double clamp system)	B208
DCLNR/L	HSK Tooling System	B231, 235
DCLNR/L	KM Tooling System	B237
DCMNN	HSK Tooling System	B231
DCMNN	KM Tooling System	B237
DCMT	PCD Insert_Positive	B113
DCMT-C25	Turning Insert_Positive (Screw on System)	B80
DCMT-FP	Turning Insert_Positive (Screw on System)	B79
DCMT-HMP	Turning Insert_Positive (Screw on System)	B79
DCMT-MP	Turning Insert_Positive (Screw on System)	B79
DCMT-VF	Turning Insert_Positive (Screw on System)	B79
DCMT-VL	Turning Insert_Positive (Screw on System)	B79
DCMT-VP1	Turning Insert_Positive (Screw on System)	B80
DDJNR/L	Holder (Double clamp system)	B168
DDJNR/L	HSK Tooling System	B231
DDJNR/L	KM Tooling System	B237
DDNNN	HSK Tooling System	B231
DDNNN	KM Tooling System	B238
DDUNR/L	Boring Bar (Double clamp system)	B208
DF	Side Cutter	E413
DNGG-VP1	Turning Insert_Negative (Multi Lock/Lever Lock, HSK Tooling System)	B47
DNGG-VP3	Turning Insert_Negative (Multi Lock/Lever Lock, HSK Tooling System)	B47
DNMA	cBN Insert_Negative (Regrinding)	B112
DNMA	Turning Insert_Negative (Multi Lock/Lever Lock, HSK Tooling System)	B46
DNMG-B25	Turning Insert_Negative (Multi Lock/Lever Lock, HSK Tooling System)	B45
DNMG-CP	Turning Insert_Negative (Multi Lock/Lever Lock, HSK Tooling System)	B44
DNMG-GR	Turning Insert_Negative (Multi Lock/Lever Lock, HSK Tooling System)	B45
DNMG-HA	Turning Insert_Negative (Multi Lock/Lever Lock, HSK Tooling System)	B48
DNMG-HM	Turning Insert_Negative	B44
DNMG-LP	Turning Insert_Negative (Multi Lock/Lever Lock, HSK Tooling System)	B43
DNMG-LW	Turning Insert_Negative (Multi Lock/Lever Lock, HSK Tooling System)	B48
DNMG-MK	Turning Insert_Negative (Multi Lock/Lever Lock, HSK Tooling System)	B46
DNMG-MM	Turning Insert_SAVE TURN	B115
DNMG-MM	Turning Insert_Negative (Multi Lock/Lever Lock, HSK Tooling System)	B46
DNMG-MP	Turning Insert_SAVE TURN	B115
DNMG-MP	Turning Insert_Negative (Multi Lock/Lever Lock, HSK Tooling System)	B44
DNMG-RK	Turning Insert_Negative (Multi Lock/Lever Lock, HSK Tooling System)	B46
DNMG-RM	Turning Insert_Negative (Multi Lock/Lever Lock, HSK Tooling System)	B47
DNMG-VB	Turning Insert_Negative (Multi Lock/Lever Lock, HSK Tooling System)	B43



K Index by designation

D

DNMG-VC	Turning Insert_Negative (Multi Lock/Lever Lock, HSK Tooling System)	B44
DNMG-VF	Turning Insert_Negative (Multi Lock/Lever Lock, HSK Tooling System)	B43
DNMG-VL	Turning Insert_Negative (Multi Lock/Lever Lock, HSK Tooling System)	B43
DNMG-VM	Turning Insert_Negative (Multi Lock/Lever Lock, HSK Tooling System)	B45
DNMG-VP1	Turning Insert_Negative (Multi Lock/Lever Lock, HSK Tooling System)	B47
DNMG-VP2	Turning Insert_Negative (Multi Lock/Lever Lock, HSK Tooling System)	B47
DNMG-VP3	Turning Insert_Negative (Multi Lock/Lever Lock, HSK Tooling System)	B47
DNMG-VP4	Turning Insert_Negative (Multi Lock/Lever Lock, HSK Tooling System)	B48
DNMG-VQ	Turning Insert_SAVE TURN	B115
DNMG-VQ	Turning Insert_Negative (Multi Lock/Lever Lock, HSK Tooling System)	B45
DNMG-VR	Turning Insert_Negative (Multi Lock/Lever Lock, HSK Tooling System)	B46
DNMG-VW	Turning Insert_Negative (Multi Lock/Lever Lock, HSK Tooling System)	B48
DNMM	PCD Insert_Negative/Positive	B113
DNMX-SH	Turning Insert_Negative (Multi Lock/Lever Lock, HSK Tooling System)	B48
DNMX-SR	Turning Insert_Negative	B48
DSBNR/L	Holder (Double clamp system)	B168
DSDNN	Holder (Double clamp system)	B169
DSKNR/L	Holder (Double clamp system)	B169
DSKNR/L	Boring Bar (Double clamp system)	B208
DSSNR/L	Holder (Double clamp system)	B169
DTFNR/L	Holder (Double clamp system)	B170
DTFNR/L	Boring Bar (Double clamp system)	B209
DTGNR/L	Holder (Double clamp system)	B170
DVJNR/L	Holder (Double clamp system)	B170
DVVNN	Holder (Double clamp system)	B171
DWLNRL	Holder (Double clamp system)	B171
DWLNRL	Boring Bar (Double clamp system)	B209

E

E2D	Drill (KED Plus-2D)	F29~30
E3D	Drill (KED Plus-3D)	F31~32
E4D	Drill (KED Plus-4D)	F33~34
E5D	Drill (KED Plus-5D)	F35~36
EF(M)4000	Mill-max	E51
EN(M)4000	Mill-max	E52
EPN(M)4000	Mill-max	E53
EPN(M)5000+	Mill-max Plus	E54
ER(L)	Thread Insert	D10~30
ER(L)H	Thread External Holder (Screw on System)	D31
ER(L)H-C	Thread External Holder (Clamp on System)	D31
ERM	Thread Insert	D10~19
EV2525R/L-105-3	HSK Tooling System	B236
EV2525R/L-112	HSK Tooling System	B236
EV2525R/L-115	HSK Tooling System	B236

F

FGD	MGT Insert	C28
FGHH	MGT Holder (Face Grooving)	C37
FGM	MGT Insert	C28
FGVH	MGT Holder (Face Grooving)	C38
FMAC(M)3000	Future Mill	E216
FMAC(M)3000-A	Future Mill (Aluminum body)	E218
FMAC(M)4000	Future Mill	E217
FMAC(M)4000-A	Future Mill (Aluminum body)	E219
FMAS3000	Future Mill	E220
FMAS4000	Future Mill	E221
FMM	MGT Insert	C28
FMPC(M)3000	Future Mill	E222
FMPC(M)3000-A	Future Mill (Aluminum body)	E224
FMPC(M)4000	Future Mill	E223
FMPC(M)4000-A	Future Mill (Aluminum body)	E225
FMPS3000	Future Mill	E226
FMPS4000	Future Mill	E227
FMRC(M)3000	Future Mill	E228
FMRC(M)4000	Future Mill	E229
FMRC(M)4000	Future Mill P-Positive	E243
FMRC(M)5000	Future Mill	E230
FMRC(M)5000	Future Mill P-Positive	E244
FMRC(M)6000	Future Mill	E231
FMRC(M)6000	Future Mill P-Positive	E245
FMRCM3000	Future Mill P-Positive	E242
FMRM1000	Future Mill	E238
FMRM1500	Future Mill	E238
FMRM2000	Future Mill	E239
FMRM2500	Future Mill	E239
FMRM2500	Future Mill P-Positive	E250
FMRM3000	Future Mill	E240
FMRM3000	Future Mill P-Positive	E251
FMRM4000	Future Mill	E241
FMRM4000	Future Mill P-Positive	E252
FMRM5000	Future Mill	E241
FMRM5000	Future Mill P-Positive	E253
FMRS1000	Future Mill	E232
FMRS1500	Future Mill	E232
FMRS2000	Future Mill	E233
FMRS2500	Future Mill	E233
FMRS2500	Future Mill P-Positive	E246
FMRS3000	Future Mill	E234
FMRS3000	Future Mill P-Positive	E247
FMRS4000	Future Mill	E235
FMRS4000	Future Mill P-Positive	E248



F

FMRS5000	Future Mill	E236
FMRS5000	Future Mill P-Positive	E249
FMRS6000	Future Mill	E237
FMRS6000	Future Mill P-Positive	E249
FP Chip Breaker	Turning Chip Breaker	B17
FS Chip Breaker	Turning Chip Breaker	B18

G

GBE	GBE (Single edge type)	E332
GBEM	GBE (Modular type)	E334
GBE-M	GBE (Multi edge type)	E333
GFIP	Multi functional holder (Grooving Tools)	C71
GW	Multi functional Insert (Grooving Tools)	C71

H

HAVE	HAVE (Multi Edge type)	E339
HAVE	HAVE (Single Edge type)	E340
HDDCM7000	Mill-max Heavy	E58
HDDCM9000	Mill-max Heavy	E58
HECN	Milling Insert (High feed Cutter)	E08
HFMD(M)-LN10	HFMD (Cutter)	E273
HFMD(M)-LN06	HFMD (Cutter)	E272
HFMD(M)-LN04	HFMD (Modular)	E274
HFMD(M)-LN06	HFMD (Modular)	E275
HFMD(M)-LN10	HFMD (Modular)	E276
HFMD(S)-LN04	HFMD (Shank)	E267
HFMD(S)-LN06	HFMD (Shank)	E269
HFMD(S)-LN10	HFMD (Shank)	E271
HFMM	HFMD (Modular)	E283
HFMS1000	HFMD (Shank)	E281
HPEN	Milling Insert (High feed Cutter)	E08
HPEN-WC	Milling Insert (High feed Cutter)	E08
HRMC(M)13	HRM	E300
HRMC(M)15	HRM	E301
HRMDC(M)09	HRMDouble	E289
HRMDC(M)13	HRMDouble	E290
HRMDC(M)16	HRMDouble	E291
HRMDM 06	HRMDouble	E297
HRMDM 09	HRMDouble	E298
HRMDM 13	HRMDouble	E299
HRMDS06	HRMDouble	E292
HRMDS09	HRMDouble	E293
HRMDS13	HRMDouble	E295

H

HRMM08	HRM	E305
HRMM10	HRM	E306
HRMM13	HRM	E306
HRMS 08	HRM	E302
HRMS 10	HRM	E302
HRMS 13	HRM	E303
HRMS 15	HRM	E304
HSK100A	Modular Adaptor (HSK)	E404
HSK100A AM3000	HSK Tooling System (Mono-Tool)	E361
HSK100A AM4000	HSK Tooling System (Mono-Tool)	E362
HSK63A	Modular Adaptor (HSK)	E404
HSK63A AM1000	HSK Tooling System (Mono-Tool)	E358
HSK63A AM1000HS	HSK Tooling System (Alpha Mill)	E353
HSK63A AM1500	HSK Tooling System (Mono-Tool)	E359
HSK63A AM1500HS	HSK Tooling System (Alpha Mill)	E354
HSK63A AM2000	HSK Tooling System (Mono-Tool)	E360
HSK63A AM2000HS	HSK Tooling System (Alpha Mill)	E355
HSK63A AM3000HS	HSK Tooling System (Alpha Mill)	E356
HSK63A AM4000HS	HSK Tooling System (Alpha Mill)	E357
HSK63A/100A PAX5000	Pro-X Mill	E393
HSK-XD19	HSK Tooling System (Mono-Tool)	E363

I

IG	Multi functional Insert (Grooving Tools)	C70
IG	Multi functional holder (Grooving Tools)	C70
IR(L)	Thread Insert	D10~30
IR(L)H	Thread External Holder (Screw on System)	D32
IR(L)H-C	Thread External Holder (Clamp on System)	D32
IRB	Indexable Reamer (Stuffed hole)	F87
IRM	Thread Insert	D10~21
IRT	Indexable Reamer (Throughout hole)	F86

K

K2D	KING DRILL-2D	F11~12
K2D	KING DRILL (for through coolant system with a lathe)-2D	F21
K2D	KING DRILL (for large diameter drilling)-2D	F25
K3D	KING DRILL-3D	F13~15
K3D	KING DRILL (for through coolant system with a lathe)-3D	F22
K3D	KING DRILL (for large diameter drilling)-3D	F25
K3D*	KING DRILL (for machining a tap foundation hole)-3D	F13~14
K4D	KING DRILL-4D	F16~17
K4D	KING DRILL (for through coolant system with a lathe)-4D	F23
K4D	KING DRILL (for large diameter drilling)-4D	F25



K Index by designation

K

K5D	KING DRILL-5D	F18~19
KCER/L	Multi functional (KGT Cartridge)	C41
KCFR/L	Multi functional (KGT Cartridge)	C41
KEL-ANN	Milling insert (Storm Mill)	E08
KEL-MF	Milling insert (Gear cutter)	E08
KEL-QNN	Milling insert (Storm Mill)	E08
KGEHR/L	Multi functional (KGT Holder)	C15
KGEHR/L-D00A	Multi functional (Auto Tool Holder)	C17
KGEHR/L-D00B	Multi functional (Auto Tool Holder)	C17
KGEHR/L-DOOA	Auto tools (KGT type)	B143
KGEHR/L-DOOB	Auto tools (KGT type)	B143
KGEHR/L-T00	Multi functional (KGT Holder)	C18
KGEUR/L	Multi functional (KGT Holder)	C20
KGEVR/L-T00	Multi functional (KGT Holder)	C19
KGFHR/L	Multi functional (KGT Holder)	C22
KGFVR/L	Multi functional (KGT Holder)	C21
KGGN-A	Multi functional Insert (KGT series)	C14
KGGN-B	Multi functional Insert (KGT series)	C13
KGGN-R	Multi functional Insert (KGT series)	C14
KGIUR/L	Multi functional (KGT Holder)	C23
KGIVR/L	Multi functional (KGT Holder)	C24
KGMI-T	Multi functional Insert (KGT series)	C13
KGML-LP	Auto tools Insert (KGT type)	B144
KGML-LP	Multi functional Insert (KGT series)	C13
KGML-RP	Auto tools Insert (KGT type)	B144
KGML-RP	Multi functional Insert (KGT series)	C13
KGMN-C	Auto tools Insert (KGT type)	B144
KGMN-L	Auto tools Insert (KGT type)	B143
KGMN-L	Multi functional Insert (KGT series)	C12
KGMN-R	Auto tools Insert (KGT type)	B143
KGMN-R	Multi functional Insert (KGT series)	C12
KGMN-T	Auto tools Insert (KGT type)	B143
KGMN-T	Multi functional Insert (KGT series)	C12
KGMR-LP	Auto tools Insert (KGT type)	B144
KGMR-LP	Multi functional Insert (KGT series)	C13
KGMR-RP	Auto tools Insert (KGT type)	B144
KGMR-RP	Multi functional Insert (KGT series)	C13
KGTB	KGT Blade for Parting off	C25
KM-DCLNR/L	KM Tooling System	B240
KNB	Multi functional Insert (K Notch, Metric)	C57
KNG	Multi functional Insert (K Notch, Metric)	C57
KNG	Multi functional Insert (K Notch, Inch)	C58
KNGP	Multi functional Insert (K Notch, Metric)	C57
KNGP	Multi functional Insert (K Notch, Inch)	C58
KNR	Multi functional Insert (K Notch, Inch)	C58

K

KNRP	Multi functional Insert (K Notch, Inch)	C58
KNSR	Multi functional (K Notch Holder)	C59
KNT	Multi functional Insert (K Notch, Threading)	C57
KNUX-11	Turning Insert_Negative (Clamp on System)	B49
KNUX-12	Turning Insert_Negative (Clamp on System)	B49
KRGN-A	Multi functional Insert (KGT series)	C14
KRMI-C	Multi functional Insert (KGT series)	C12
KRMN-C	Auto tools Insert (KGT type)	B144
KRMN-C	Multi functional Insert (KGT series)	C12
KSPB	Multi functional (Saw Man-X, Blade)	C65
KSPH	Multi functional(Saw Man-X, Shank)	C66

L

LBE08/10/12/16/20/25/30/32	Laser Mill (Carbide Shank-Ball, Straight type)	E326
LBE08/10/12/16/20/25/30/32	Laser Mill (Steel Shank-Ball, Taper type)	E327
LBE12/16/20/25/30/32	Laser Mill (Steel Shank-Ball, Straight type)	E327
LBE-MHD	Laser Mill (Modular type)	E330
LBH	Milling Insert (Laser Mill)	E08
LBH-KF	Milling Insert (Laser Mill)	E08
LBH-KH	Milling Insert (Laser Mill)	E09
LBS	Milling Insert (Laser Mill)	E09
LCF	Milling Insert (Laser Mill)	E09
LDET	Milling Insert (Pro-XL Mill)	E09
LDET-MA	Milling Insert (Pro-XL Mill)	E10
LFH	Milling Insert (Laser Mill)	E09
LNCS	Milling Insert (Rich Mill)	E10
LNE	Milling Insert (Gear cutter)	E10
LNEX-MA	Milling Insert (Rich Mill)	E11
LNEX-MF	Milling Insert (Rich Mill)	E11
LNEX-MM	Milling Insert (Rich Mill)	E11
LNKT-MA	Milling Insert (TP2P)	E10
LNKT-ML	Milling Insert (TP2P)	E11
LNKT-MM	Milling Insert (TP2P)	E11
LNMX-MF	Milling Insert (Rich Mill)	E11
LNMX-MF	Milling Insert (HFMD)	E12
LNMX-ML	Milling Insert (HFMD)	E12
LNMX-MM	Milling Insert (Rich Mill)	E11
LNMX-MM	Milling Insert (HFMD)	E12
LP Chip Breaker	Turning Chip Breaker	B20
LPEW	Milling Insert (HFM)	E12
LPMT-MF	Milling Insert (HFM)	E12
LPMW	Milling Insert (HFM)	E13
LR	Milling Insert (Laser Mill)	E09
LRE10/12	Laser Mill (Steel Shank-Corner R, Taper type)	E329



L

LRE10/12/16/20/25/30/32	Laser Mill (Carbide Shank-Corner R, Straight type)	E328
LRE12/16/25/30/32	Laser Mill (Steel Shank-Corner R, Straight type)	E329
LRH	Milling Insert (Laser Mill)	E09
LW Chip Breaker	Turning Chip Breaker	B32
LXET-MA	Milling Insert (Pro-L Mill)	E13
LXET-ML	Milling Insert (Pro-L Mill)	E13

M

MAPD000HR/L-ZO	Aero Mill-Mini	E155
MAPDS000HR/L-ZO	Aero Mill-Mini	E154
MAT	Modular Adaptor (Steel Shank)	E401
MAT-C	Modular Adaptor (Carbide Shank)	E402
MBBR	Auto tools (MSB Tools_Back Boring)	B148
MBCR	Auto tools (MSB Tools_Copying)	B147
MBFR	Auto tools ((MSB Tools_Chamfering)	B148
MBR	Auto tools ((MSB Tools_Boring)	B147
MC	Multi functional Insert (Bearing Solution)	B156
MCER/L	HSK Tooling System (Cartridge)	B234
MCER/L	KM Tooling System (Cartridge)	B240
MCER/L	Multi functional (MGT Cartridge)	C42
MCFR/L	HSK Tooling System (Cartridge)	B235
MCFR/L	Multi functional (MGT Cartridge)	C42
MCHR/L	HSK Tooling System	B234
MCHR/L	KM Tooling System (Cartridge)	B239
MCHR/L	Multi functional (MGT Cartridge Holder)	C40
MCKNR/L	Holder (Multi Lock System)	B183
MCLNR/L	Holder (Multi Lock System)	B183
MCLNR/L	Boring Bar (Multi Lock System)	B213
MCMNN	Holder (Multi Lock System)	B183
MCRNR/L	Holder (Multi Lock System)	B184
MCVR/L	Multi functional (MGT Cartridge Holder)	C40
MDJNR/L	Holder (Multi Lock System)	B184
MDNNN	Holder (Multi Lock System)	B184
MDQNR/L	Holder (Multi Lock System)	B185
MDUNR/L	Boring Bar (Multi Lock System)	B213
MFMN	Multi functional Insert (MGT Cartridge, MGT)	C28
MGEHR/L	Auto tools (MGT type)	B144
MGEHR/L	Multi functional (MGT Holder)	C31
MGEHR/L	Multi functional (MGT for Aluminum Wheel)	C45
MGEHR/L-15	Multi functional (MGT for Aluminum Wheel)	C45
MGEUR/L	Multi functional (MGT Holder)	C32
MGEVR/L	Multi functional (MGT Holder)	C33
MGEXR/L	Multi functional (MGT for Aluminum Wheel)	C46
MGFHR/L	Multi functional (MGT Holder)	C36

M

MGFR	Auto tools (MSB Tools_Face Grooving)	B150
MGFVR/L	Multi functional (MGT Holder)	C36
MGGN-A	Multi functional Insert (MGT Cartridge, MGT)	C29
MGGN-M	Multi functional Insert (MGT Cartridge, MGT)	C28
MGIUR/L	Multi functional (MGT Holder)	C34
MGIUR/L-MR	Multi functional (MGT for Aluminum Wheel)	C45
MGIUR/L-MV	Multi functional (MGT for Aluminum Wheel)	C46
MGIVR/L	Multi functional (MGT Holder)	C35
MGIXR/L-MR	Multi functional (MGT for Aluminum Wheel)	C46
MGML-PS	Multi functional Insert (MGT Cartridge, MGT)	C30
MGML-PT	Multi functional Insert (MGT Cartridge, MGT)	C30
MGMN-G	Auto tools Insert (MGT type)	B144
MGMN-G	Multi functional Insert (MGT Cartridge, MGT)	C28
MGMN-L	Multi functional Insert (MGT Cartridge, MGT)	C29
MGMN-M	Auto tools Insert (MGT type)	B144
MGMN-M	Multi functional Insert (MGT Cartridge, MGT)	C28
MGMN-R	Multi functional Insert (MGT Cartridge, MGT)	C29
MGMN-T	Multi functional Insert (MGT Cartridge, MGT)	C29
MGMR-PS	Multi functional Insert (MGT Cartridge, MGT)	C30
MGMR-PT	Multi functional Insert (MGT Cartridge, MGT)	C30
MGR	Auto tools (MSB Tools_Square Grooving)	B149
MGRR	Auto tools (MSB Tools_Round Grooving)	B150
MK Chip Breaker	Turning Chip Breaker	B24
MM Chip Breaker	Turning Chip Breaker	B22
MP Chip Breaker	Turning Chip Breaker	B21
MPMT	Milling Insert	E14
MRGN-A	Multi functional Insert (MGT Cartridge, MGT)	C30
MRGN-A	Multi functional Insert (MGT for Aluminum Wheel)	C44
MRMN-M	Multi functional Insert (MGT Cartridge, MGT)	C30
MS Chip Breaker	Turning Chip Breaker	B19
MSBNR/L	Holder (Multi Lock System)	B185
MSDNN	Holder (Multi Lock System)	B185
MSKNR/L	Holder (Multi Lock System)	B186
MSKNR/L	Boring Bar (Multi Lock System)	B213
MSRNR/L	Holder (Multi Lock System)	B186
MSSNR/L	Holder (Multi Lock System)	B187
MT	Multi functional (Multi Turn)	B154
MTENN	Holder (Multi Lock System)	B187
MTFNR/L	Holder (Multi Lock System)	B187
MTFNR/L	Boring Bar (Multi Lock System)	B214
MTGNR/L	Holder (Multi Lock System)	B188
MTJNR/L	Holder (Multi Lock System)	B188
MTR	Auto tools (MSB Tools_Threading)	B151
MVGN	Multi functional Insert (MGT for Aluminum Wheel)	C44
MVJNR/L	Holder (Multi Lock System)	B188



K Index by designation

M

MVQNR/L	Holder (Multi Lock System)	B189
MVUNR/L	Boring Bar (Multi Lock System)	B214
MVVNN	Holder (Multi Lock System)	B189
MWLNRL	Holder (Multi Lock System)	B189
MWLNRL	Boring Bar (Multi Lock System)	B214

N

NFTFR/L	Multi functional Insert (Fine Tools)	C69
NFTGR/L	Multi functional Insert (Fine Tools)	C68
NFTIH	Multi functional (Fine Tools Holder)	C69
NFTTR/L	Multi functional Insert (Fine Tools)	C68
NU-CCGW	cBN Insert_Positive (Multi-Corner Type)	B111
NU-CNGA	cBN Insert_Negative (Multi-Corner Type)	B110
NU-DCGW	cBN Insert_Positive (Multi-Corner Type)	B111
NU-DNGA	cBN Insert_Negative (Multi-Corner Type)	B110
NU-SNGA	cBN Insert_Negative (Multi-Corner Type)	B110
NU-TCGW	cBN Insert_Positive (Multi-Corner Type)	B111
NU-TNGA	cBN Insert_Negative (Multi-Corner Type)	B110
NU-TPGB	cBN Insert_Positive (Multi-Corner Type)	B111
NU-TPGN	cBN Insert_Positive (Multi-Corner Type)	B111
NU-TPGW	cBN Insert_Positive (Multi-Corner Type)	B111
NU-VBGW	cBN Insert_Positive (Multi-Corner Type)	B111
NU-VCGW	cBN Insert_Positive (Multi-Corner Type)	B111
NU-VNGA	cBN Insert_Negative (Multi-Corner Type)	B110

O

OFCN	Milling Insert (Double Mill)	E14
OFCW	Milling Insert (Double Mill)	E14
OFKR-MA	Milling Insert (Double Mill)	E14
OFKR-MF	Milling Insert (Double Mill)	E14
OFKR-MM	Milling Insert (Double Mill)	E14
OFKT-MA	Milling Insert (Double Mill)	E14
OFKT-MF	Milling Insert (Double Mill)	E14
OFKT-MM	Milling Insert (Double Mill)	E15
ONHX-MA	Milling Insert (Rich Mill)	E15
ONHX-MF	Milling Insert (Rich Mill)	E15
ONHX-ML	Milling Insert (Rich Mill)	E15
ONHX-MM	Milling Insert (Rich Mill)	E15
ONHX-W	Milling Insert (Rich Mill)	E15
ONMX-MF	Milling Insert (Rich Mill)	E15
ONMX-MM	Milling Insert (Rich Mill)	E15
ORC	O-ring Cutter	E365
ORG	Milling Insert (O-Ring Cutter)	E15

P

PAC(M)2000	Pro-A Mill	E385
PAC(M)4000	Pro-A Mill	E385
PALCM	Pro-L Mill	E394
PALS (Multi-edge)	Pro-L Mill	E397
PALS (Single-edge)	Pro-L Mill	E395
PAM2000	Pro-A Mill	E387
PAS2000	Pro-A Mill	E386
PAS4000	Pro-A Mill	E386
PAVCM-XD19	Pro-V Mill	E399
PAVS-XD19	Pro-V Mill	E400
PAXC(M)5000	Pro-X Mill	E388
PAXC(M)6000	Pro-X Mill	E389
PAXM5000	Pro-X Mill	E392
PAXS5000	Pro-X Mill	E390
PAXS6000	Pro-X Mill	E391
PBAC(M)5000	Power Buster	E68
PBPCM6000	Power Buster	E70
PBZC(M)5000	Power Buster	E69
PCBNR/L	Holder (SAVE TURN)	B116
PCBNR/L	Holder (Lever Lock System)	B172
PCKNR/L	Holder (Lever Lock System)	B172
PCLNR	Holder (KHP)	B202
PCLNR/L	Holder (SAVE TURN)	B116
PCLNR/L	Boring Bar (SAVE TURN)	B119
PCLNR/L	Holder (Lever Lock System)	B173
PCLNR/L	Boring Bar (Lever Lock System)	B210
PCLNR/L	HSK Tooling System	B232
PCLNR/L	KM Tooling System	B238
PCMNN	HSK Tooling System	B232
PCMNN	KM Tooling System	B238
PDF	PCD Face Cutter	E156
PDJNR	Holder (KHP)	B202
PDJNR/L	Holder (SAVE TURN)	B116
PDJNR/L	Holder (Lever Lock System)	B173
PDJNR/L	HSK Tooling System	B232
PDJNR/L	KM Tooling System	B239
PDNNN	HSK Tooling System	B232
PDNNN	KM Tooling System	B239
PDNNR/L	Holder (SAVE TURN)	B117
PDNNR/L	Holder (Lever Lock System)	B174
PDQNR/L	Holder (SAVE TURN)	B117
PDSNR/L	Boring Bar (Lever Lock System)	B210
PDUNR/L	Boring Bar (SAVE TURN)	B119
PDUNR/L	Boring Bar (Lever Lock System)	B210
PDZNR/L	Boring Bar (SAVE TURN)	B120



P

PES2000	Turbo Mill	E61
PES3000	Turbo Mill	E61
PES4000	Turbo Mill	E61
PF(M)4000	Mill-max	E55
PNEJ	Milling Insert (Side Cutter)	E16
PNEJ-C	Milling Insert (Side Cutter)	E16
PPN(M)4000	Mill-max	E56
PRDCN	Holder (Lever Lock System)	B174
PRDCN	HSK Tooling System	B233
PRGCR/L	Holder (Lever Lock System)	B175
PRGCR/L	HSK Tooling System	B233
PSBNR/L	Holder (SAVE TURN)	B117
PSBNR/L	Holder (Lever Lock System)	B175
PSDNN	Holder (SAVE TURN)	B118
PSDNN	Holder (Lever Lock System)	B176
PSKNR/L	Holder (SAVE TURN)	B118
PSKNR/L	Boring Bar (SAVE TURN)	B120
PSKNR/L	Holder (Lever Lock System)	B176
PSKNR/L	Boring Bar (Lever Lock System)	B211
PSSNR	Holder (KHP)	B202
PSSNR/L	Holder (SAVE TURN)	B118
PSSNR/L	Holder (Lever Lock System)	B177
PT	Tap Series (Point Tap)	D80
PTFNR/L	Holder (Lever Lock System)	B177
PTFNR/L	Boring Bar (Lever Lock System)	B211
PTGNR/L	Holder (Lever Lock System)	B178
PTTNR/L	Holder (Lever Lock System)	B178
PWLNR	Holder (KHP)	B203
PWLNR/L	Holder (SAVE TURN)	B119
PWLNR/L	Boring Bar (SAVE TURN)	B120
PWLNR/L	Holder (Lever Lock System)	B178
PWLNR/L	Boring Bar (Lever Lock System)	B211
PXL(S)	Pro-XL Mill	E398

Q

QCGT	Multi functional Insert (Multi Turn)	B154
QCMT	Multi functional Insert (Multi Turn)	B154

R

RAFCB	Side Milling Cutter (Radial type-Full side cutter)	E409
RAFCP	Side Milling Cutter (Radial type-Full side cutter)	E409
RAHCB	Side Milling Cutter (Radial type-Half side cutter)	E410
RAHCP	Side Milling Cutter (Radial type-Half side cutter)	E410

R

RC	Milling Insert (BFE)	E16
RCGT-AK	Aluminum Insert_Positive (Screw on System)	B105
RCGT-AR	Aluminum Insert_Positive (Screw on System)	B105
RCMT-VM	Turning Insert_Positive (Screw on System)	B83
RCMX	Turning Insert_Positive (Screw on System)	B83
RDCT-MA	Milling Insert (Future Mill)	E16
RDHW	Milling Insert (Future Mill)	E16
RDKT-MF	Milling Insert (Future Mill)	E17
RDKT-ML	Milling Insert (Future Mill)	E17
RDKT-MM	Milling Insert (Future Mill)	E17
RDKW	Milling Insert (Future Mill)	E17
REKR-MM	Milling Insert (Double Mill)	E17
RI	Drill (Indexable Reamer Insert)	F85
RK Chip Breaker	Turning Chip Breaker	B25
RM Chip Breaker	Turning Chip Breaker	B23
RM14XCM-XN06	Rich Mill	E142
RM16AC(M)6000	Rich Mill	E143
RM16AC(M)8000	Rich Mill	E144
RM3PC(M)3000	Rich Mill	E99
RM3PC(M)4000	Rich Mill	E100
RM3PC(M)5000	Rich Mill	E101
RM3PM3000	Rich Mill	E104
RM3PM4000	Rich Mill	E104
RM3PS3000	Rich Mill	E102
RM3PS4000	Rich Mill	E103
RM4PC(M)3000	Rich Mill	E105
RM4PC(M)4000	Rich Mill	E106
RM4PFCB3000	Rich Mill	E107
RM4PFCB4000	Rich Mill	E108
RM4PFCP3000	Rich Mill	E111
RM4PFCP4000	Rich Mill	E112
RM4PHCB3000	Rich Mill	E109
RM4PHCB4000	Rich Mill	E110
RM4PHCP3000	Rich Mill	E113
RM4PHCP4000	Rich Mill	E114
RM4PM3000	Rich Mill	E117
RM4PS3000	Rich Mill	E115
RM4PS4000	Rich Mill	E116
RM4ZC(M)3000	Rich Mill	E118
RM4ZC(M)4000	Rich Mill	E118
RM4ZM3000	Rich Mill	E119
RM4ZS3000	Rich Mill	E119
RM6PC(M)-WN08	Rich Mill	E121
RM6PCM-WN04	Rich Mill	E120
RM6PM-WN04	Rich Mill	E124



K Index by designation

R

RM6PM-WN08	Rich Mill	E125
RM6PS-WN04	Rich Mill	E122
RM6PS-WN08	Rich Mill	E123
RM8AC(M)4000	Rich Mill	E126
RM8AC(M)5000	Rich Mill	E128
RM8EC(M)4000	Rich Mill	E130
RM8EC(M)5000	Rich Mill	E132
RM8QC(M)4000	Rich Mill	E134
RMH8AC(M)4000	Rich Mill	E127
RMH8AC(M)5000	Rich Mill	E129
RMH8EC(M)4000	Rich Mill	E131
RMH8EC(M)5000	Rich Mill	E133
RMH8QC(M)4000	Rich Mill	E135
RMRC(M)-RN12	Rich Mill	E145
RMRS-RN12	Rich Mill	E146
RMT8A(M)4000	Rich Mill	E136
RMT8A(M)5000	Rich Mill	E137
RMT8E(M)4000	Rich Mill	E138
RMT8E(M)5000	Rich Mill	E139
RMT8Q(M)4000	Rich Mill	E140
RMX8AC(M)-SA14	Rich Mill	E141
RNMG-B25	Turning Insert_Negative	B49
RNMX-ML	Milling Insert (Rich Mill)	E17
RPCT-MA	Milling Insert (Future Mill P-Positive)	E17
RPET-ML	Milling Insert (Future Mill P-Positive)	E18
RPGT	Multi functional Insert (Bearing Solution)	B158
RPMT-MF	Milling Insert (Future Mill P-Positive)	E18
RPMT-MM	Milling Insert (Future Mill P-Positive)	E18
RPMW	Milling Insert (Future Mill P-Positive)	E18
RT	Tap Series (Roll Tap)	D77, 82

S

SAGX-ML	Milling Insert (Rich Mill)	E18
SAGX-MM	Milling Insert (Rich Mill)	E18
SBBR/L	Auto Tools Insert (Blade type)	B137
SBCR/L	Auto Tools Insert (Blade type)	B138
SBGR/L	Auto Tools Insert (Blade type)	B137
SBHR/L	Holder (Auto Tools_Blade type)	B137
SBHR/L-X	Holder (Auto Tools_Blade type)	B137
SBR/L	Auto Tools Insert (Multi utility type)	B140
SBTR/L	Auto Tools Insert (Blade type)	B137
SCACR/L	Holder (Auto Tools_ISO type)	B123
SCACR/L	Holder (Screw on System)	B190
SCGT-AK	Aluminum Insert_Positive (Screw on System)	B106

S

SCGT-AR	Aluminum Insert_Positive (Screw on System)	B106
SCKN	Milling Insert (Mill Max Heavy)	E19
SCLCR/L	Holder (Auto Tools_ISO type)	B123
SCLCR/L	Holder (Auto Tools_KHP)	B129
SCLCR/L	Holder (Screw on System)	B190
SCLCR/L	Boring Bar (Screw on System)	B215
SCLCR/L	Compact Mini	B225
SCLPR/L	Boring Bar (Screw on System)	B216
SCMT-C25	Turning Insert_Positive (Screw on System)	B84
SCMT-FP	Turning Insert_Positive (Screw on System)	B84
SCMT-HMP	Turning Insert_Positive (Screw on System)	B84
SCMT-MP	Turning Insert_Positive (Screw on System)	B84
SCMT-VF	Turning Insert_Positive (Screw on System)	B84
SCMT-VL	Turning Insert_Positive (Screw on System)	B84
SCR/L	Auto Tools Insert (Multi utility type)	B140
SDACR/L	Holder (Screw on System)	B190
SDCN	Milling Insert (Mill-max, High feed Cutter)	E19
SDET-MA	Milling Insert (Future Mill)	E19
SDET-MF	Milling Insert (Future Mill)	E19
SDET-MM	Milling Insert (Future Mill)	E19
SDJCR/L	Holder (Auto Tools-ISO Type)	B123
SDJCR/L	Holder (Auto Tools-KHP)	B129
SDJCR/L	Holder (Screw on System)	B191
SDKN-CM	Milling Insert	E19
SDKN-MU	Milling Insert (Mill-Max)	E20
SDKN-SU	Milling Insert (Mill-max, Turbo Mill)	E20
SDKR-MX	Milling Insert (Mill-max, Turbo Mill)	E20
SDMT-MM	Milling Insert (Tank Mill, GBE)	E20
SDNCN	Holder (Auto Tools-ISO Type)	B124
SDNCN	Holder (Screw on System)	B191
SDQCR/L	Boring Bar (Screw on System)	B217
SDUCR/L	Boring Bar (Screw on System)	B218
SDXT-MA	Milling Insert (Future Mill)	E20
SDXT-MF	Milling Insert (Future Mill)	E20
SDXT-MM	Milling Insert (Future Mill)	E20
SDZCR/L	Boring Bar (Screw on System)	B219
SECA	Milling Insert	E20
SECN	Milling Insert (Mill-max)	E21
SEET-MA	Milling Insert (Future Mill)	E21
SEET-MF	Milling Insert (Future Mill)	E21
SEET-MM	Milling Insert (Future Mill)	E21
SEEW	Milling Insert (Future Mill)	E21
SEEW-W	Milling Insert (Future Mill)	E21
SEKN-SU	Milling Insert (Mill-max)	E21
SEKR-MX	Milling Insert (Mill-max)	E22



S

SEM N	Milling Insert	E22
SEXT-MF	Milling Insert (Future Mill)	E22
SEXT-MM	Milling Insert (Future Mill)	E22
SEXT-MR	Milling Insert (Future Mill)	E22
SFCN	Milling Insert (Mill-max)	E22
SGBR/L	Auto Tools Insert (Multi utility type)	B141
SGR/L	Auto Tools Insert (Multi utility type)	B141
SH Chip Breaker	Turning Chip Breaker	B33
SL	Sleeve	B151
SMBB	Multi functional(Saw Man_Block)	C61
SMBB	Multi functional(Saw Man-X_Block)	C65
SNCF-MF	Milling Insert (Rich Mill)	E22
SNCF-MM	Milling Insert (Rich Mill)	E23
SNCN	Milling Insert (Mill-max)	E23
SNEF	Milling Insert (High feed Cutter)	E23
SNEU-MF	Milling Insert (Shave Mill)	E23
SNEU-TBW	Milling Insert (Shave Mill)	E24
SNEU-WMF	Milling Insert (Shave Mill)	E24
SNEW	Milling Insert (Aero Mill-Mini)	E24
SNEW-NAF	Milling Insert (Aero Mill-Mini)	E24
SNEW-XAF	Milling Insert (Aero Mill-Mini)	E24
SNEX	Milling Insert (Cube Mill)	E24
SNEX-CU1	Milling Insert (Cube Mill)	E24
SNEX-MA	Milling Insert (Rich Mill)	E24
SNEX-MF	Milling Insert (Rich Mill)	E25
SNEX-ML	Milling Insert (Rich Mill)	E24
SNEX-MM	Milling Insert (Rich Mill)	E25
SNEX-W	Milling Insert (Rich Mill)	E26
SNGA	Turning Insert_Negative (Multi Lock/Lever Lock System)	B54
SNGG	Turning Insert_Negative (Multi Lock/Lever Lock System)	B53
SNGG-VP3	Turning Insert_Negative (Multi Lock/Lever Lock System)	B55
SNGN	Turning Insert_Negative (Lever Lock System/Ceramic Holder)	B56
SNGX	Turning Insert_Negative (Multi Lock/Lever Lock System)	B57
SNHT-WX	Milling Insert (Wind Mill)	E25
SNKN	Milling Insert (Mill-max)	E25
SNMA	Turning Insert_Negative (Multi Lock/Lever Lock System)	B53
SNMF-MF	Milling Insert (Rich Mill)	E22
SNMF-MM	Milling Insert (Rich Mill)	E23
SNMG-B25	Turning Insert_Negative (Multi Lock/Lever Lock System)	B52
SNMG-CP	Turning Insert_Negative (Multi Lock/Lever Lock System)	B50
SNMG-GR	Turning Insert_Negative (Multi Lock/Lever Lock System)	B52
SNMG-HA	Turning Insert_Negative (Multi Lock/Lever Lock System)	B56
SNMG-HM	Turning Insert_Negative	B51
SNMG-LP	Turning Insert_Negative (Multi Lock/Lever Lock System)	B50
SNMG-MK	Turning Insert_Negative (Multi Lock/Lever Lock System)	B53

S

SNMG-MM	Turning Insert (SAVE TURN)	B115
SNMG-MM	Turning Insert_Negative (Multi Lock/Lever Lock System)	B54
SNMG-MP	Turning Insert (SAVE TURN)	B115
SNMG-MP	Turning Insert_Negative (Multi Lock/Lever Lock System)	B51
SNMG-RK	Turning Insert_Negative (Multi Lock/Lever Lock System)	B54
SNMG-RM	Turning Insert_Negative (Multi Lock/Lever Lock System)	B55
SNMG-VB	Turning Insert_Negative (Multi Lock/Lever Lock System)	B50
SNMG-VC	Turning Insert_Negative (Multi Lock/Lever Lock System)	B50
SNMG-VF	Turning Insert_Negative (Multi Lock/Lever Lock System)	B50
SNMG-VL	Turning Insert_Negative (Multi Lock/Lever Lock System)	B50
SNMG-VM	Turning Insert_Negative (Multi Lock/Lever Lock System)	B51
SNMG-VP2	Turning Insert_Negative (Multi Lock/Lever Lock System)	B55
SNMG-VP3	Turning Insert_Negative (Multi Lock/Lever Lock System)	B55
SNMG-VP4	Turning Insert_Negative (Multi Lock/Lever Lock System)	B55
SNMG-VQ	Turning Insert (SAVE TURN)	B115
SNMG-VQ	Turning Insert_Negative (Multi Lock/Lever Lock System)	B52
SNMG-VR	Turning Insert_Negative (Multi Lock/Lever Lock System)	B54
SNMM-GH	Turning Insert_Negative (Multi Lock/Lever Lock System)	B57
SNMM-GR	Turning Insert_Negative (Multi Lock/Lever Lock System)	B57
SNMM-VH	Turning Insert_Negative (Lever Lock System)	B57
SNMM-VT	Turning Insert_Negative (Lever Lock System)	B57
SNMX	Turning Insert_Negative (Ceramic Holder)	B56
SNMX-MF	Milling Insert (Rich Mill)	E25
SNMX-MM	Milling Insert (Alpha Mill)	E18
SNMX-MM	Milling Insert (Rich Mill)	E25
SNUN	Turning Insert_Negative (Ceramic Holder)	B56
SP	Multi functional Insert (Saw Man)	C60
SP	Tap series (Spiral Tap)	D76, 81
SPB	Multi functional (Saw Man_Blades)	C61
SPB(M)	Side Cutter	E412
SPB-S	Multi functional (Saw Man_Blades)	C61
SPCN	Milling Insert (Mill-max)	E26
SPEN-WC	Milling Insert (High feed Cutter)	E26
SPET-ND	Drill Insert (KING DRILL)	F03
SPEX	Milling Insert (Mill-max)	E26
SPFN	Milling Insert (Side Cutter)	E26
SPGA	Turning Insert_Positive	B86
SPGH	Multi functional Insert (Bearing Solution)	B158
SPGN	PCD Insert_Positive	B113
SPGN	Turning Insert_Positive	B86
SPGR	Multi functional Insert (Bearing Solution)	B158
SPGR-F	Turning Insert_Positive (Clamp on System)	B85
SPGR-M	Turning Insert_Positive (Clamp on System)	B85
SPGT	Turning Insert_Positive (Screw on System)	B86
SPH	Multi functional (Saw Man_Holder)	C62

K Index by designation

S

SPH-S	Multi functional (Saw Man_Holder)	C62
SPKN-MU	Milling Insert (Mill-max)	E27
SPKN-SU	Milling Insert (Mill-max)	E27
SPKR-MX	Milling Insert (Mill-max)	E27
SPMN	Milling Insert (Chamfer tools)	E27
SPMR-F	Turning Insert_Positive (Clamp on System)	B85
SPMR-M	Turning Insert_Positive (Clamp on System)	B85
SPMT	Milling Insert (Tank Mill, GBE, BT Tooling System)	E27
SPMT-KC	Milling Insert (Chamfer tools)	E27
SPMT-LD	Drill Insert (KING DRILL)	F03
SPMT-MM	Milling Insert (Tank Mill, GBE)	E27
SPMT-PD	Drill Insert (KING DRILL)	F03
SPMT-VF	Turning Insert_Positive (Clamp on System)	B85
SPMT-VL	Turning Insert_Positive	B85
SPP(M)	Side Cutter	E411
SPS	Side Cutter	E413
SPUN	Turning Insert_Positive	B85
SR	Tap series (Spiral Roll Tap)	D78, 83
SR Chip Breaker	Turning Chip Breaker	B33
SRCPR/L...B	Bearing Solution	B157
SRDCN	Holder (Screw on System)	B191
SRGCR	Holder (KHP)	B203
SRGCR/L	Holder (Screw on System)	B192
SRGPR/L...E	Bearing Solution	B157
SRGPR/L...F	Bearing Solution	B157
SSBCR/L	Holder (Screw on System)	B192
SDDCN	Holder (Screw on System)	B192
SSKCR/L	Holder (Screw on System)	B193
SSKCR/L	Boring Bar (Screw on System)	B219
SSKCR/L	Cartridge (Screw on System)	B245
SSKPR/L	Boring Bar (Screw on System)	B219
SSKPR/L...B	Bearing Solution	B158
SSSCR/L	Holder (Screw on System)	B193
SSSCR/L	Cartridge (Screw on System)	B246
ST	Tap series (Straight Tap)	D75, 79
STACR/L	Holder (Auto Tools-ISO Type)	B124
STACR/L	Holder (Screw on System)	B193
STFCR/L	Holder (Screw on System)	B194
STFCR/L	Boring Bar (Screw on System)	B220
STFCR/L	Cartridge (Screw on System)	B246
STFPR/L	Boring Bar (Screw on System)	B221
STGCR/L	Holder (Screw on System)	B194
STLBR/L	Compact Mini	B225
STMD1T	Solid Threading Endmills (ISO Metric)	D64, 68
STMD2L	Solid Threading Endmills (ISO Metric / UN)	D69~70

S

STMD3T	Solid Threading Endmills (ISO Metric / UN)	D65~67
STMH	Solid Threading Endmills (ISO Metric)	D57~60
STMHC	Solid Threading Endmills (ISO Metric)	D51~56
STMS	Solid Threading Endmills (ISO Metric)	D61~63
STR/L	Auto Tools Insert (Multi utility type)	B141
STTCR/L	Holder (Screw on System)	B194
STTCR/L	Cartridge (Screw on System)	B247
STUBR/L	Compact Mini	B225
STUPR/L	Compact Mini	B226
STWCR/L	Cartridge (Screw on System)	B247
STWPR/L	Boring Bar (Screw on System)	B222
SVABR/L	Holder (Screw on System)	B195
SVACR/L	Holder (Auto Tools-ISO Type)	B124
SVAPR/L	Holder (Auto Tools-ISO Type)	B125
SVHBR/L	Holder (Screw on System)	B195
SVJBR	Holder (KHP)	B203
SVJBR/L	Holder (Auto Tools-ISO Type)	B125
SVJBR/L	Holder (Screw on System)	B195
SVJCR/L	Holder (Auto Tools-ISO Type)	B125
SVJCR/L	Holder (Auto Tools-KHP)	B129
SVJCR/L	Holder (Screw on System)	B196
SVJCR/L	Boring Bar (Screw on System)	B222
SVJPR/L	Holder (Auto Tools-ISO Type)	B126
SVPBR/L	HSK Tooling System	B233
SVQBR/L	Boring Bar (Screw on System)	B222
SVQCR/L	Boring Bar (Screw on System)	B223
SVUBR/L	Boring Bar (Screw on System)	B223
SVUCR/L	Boring Bar (Screw on System)	B223
SVVBN	Holder (Screw on System)	B196
SVVBN	HSK Tooling System	B233
SVVCN	Holder (Screw on System)	B196
SVVPN	Holder (Auto Tools-ISO Type)	B126
SWLCR/L	Boring Bar (Screw on System)	B224
SWUBR/L	Compact Mini	B227
SXGNR/L	Holder (Auto Tools_Multi utility type)	B140

T

TAFCB	Side Milling Cutter (Tangential type-Full side cutter)	E407
TAFCP	Side Milling Cutter (Tangential type-Full side cutter)	E407
TAHCB	Side Milling Cutter (Tangential type-Half side cutter)	E408
TAHCP	Side Milling Cutter (Tangential type-Half side cutter)	E408
TB	Multi functional Insert (Grooving Tools)	C51
TBGT	Turning Insert_Positive (Compact Mini)	B87
TBH	Multi functional (Grooving Tools)	C54



T

TB-M	Multi functional Insert (Grooving Tools)	C52
TBMT-VL	Turning Insert_Positive (Screw on System)	B87
TB-P	Multi functional Insert (Grooving Tools)	C53
TCGT-AK	Aluminum Insert_Positive (Screw on System)	B107
TCGT-AR	Aluminum Insert_Positive (Screw on System)	B107
TCGT-FS	Auto tools Insert (ISO type)	B133
TCGT-FS	Turning Insert_Positive (Screw on System)	B89
TCGT-KF	Auto tools Insert (ISO type)	B133
TCGT-KF	Turning Insert_Positive (Screw on System)	B89
TCGT-VP1	Turning Insert_Positive (Screw on System)	B89
TCMT-C25	Turning Insert_Positive (Screw on System)	B89
TCMT-FP	Turning Insert_Positive (Screw on System)	B88
TCMT-HMP	Turning Insert_Positive (Screw on System)	B88
TCMT-MP	Turning Insert_Positive (Screw on System)	B88
TCMT-VF	Turning Insert_Positive (Screw on System)	B88
TCMT-VL	Turning Insert_Positive (Screw on System)	B88
TCMT-VP1	Turning Insert_Positive (Screw on System)	B89
T-CNMA	cBN Insert_Negative(Regrinding)	B112
T-DCGW	cBN Insert_Positive(Regrinding)	B112
TEC(E)N	Milling Insert (Turbo Mill)	E27
TEEN	Milling Insert (Turbo Mill)	E27
TFCN	Milling Insert (Mill-max)	E28
TFE	T-Cutter	E374
THE	Tank Mill	E307
TM	Thread Milling Inserts (ISO Metric)	D44~49
TNGA	Turning Insert_Negative (Lever Lock/Wedge Clamp/Multi Lock System)	B62
TNGG	Turning Insert_Negative (Lever Lock/Wedge Clamp/Multi Lock System)	B61
TNGG-SC	Turning Insert_Negative (Lever Lock/Wedge Clamp/Multi Lock System)	B60
TNGG-VP3	Turning Insert_Negative (Lever Lock/Wedge Clamp/Multi Lock System)	B63
TNGN	Turning Insert_Negative (Ceramic Holder)	B64
TNKT-ML	Milling Insert (Triple Mill)	E28
TNKT-MM	Milling Insert (Triple Mill)	E28
TNMA	cBN Insert_Negative(Regrinding)	B112
TNMA	Turning Insert_Negative (Lever Lock/Wedge Clamp/Multi Lock System)	B61
TNMG-B25	Turning Insert_Negative (Lever Lock/Wedge Clamp/Multi Lock System)	B60
TNMG-CP	Turning Insert_Negative (Lever Lock/Wedge Clamp/Multi Lock System)	B58
TNMG-GR	Turning Insert_Negative (Lever Lock/Wedge Clamp/Multi Lock System)	B60
TNMG-HA	Turning Insert_Negative (Lever Lock/Wedge Clamp/Multi Lock System)	B63
TNMG-HM	Turning Insert_Negative	B59
TNMG-LP	Turning Insert_Negative (Lever Lock/Wedge Clamp/Multi Lock System)	B58
TNMG-LW	Turning Insert_Negative (Lever Lock/Wedge Clamp/Multi Lock System)	B64
TNMG-MK	Turning Insert_Negative (Lever Lock/Wedge Clamp/Multi Lock System)	B61
TNMG-MM	Turning Insert_Negative (Lever Lock/Wedge Clamp/Multi Lock System)	B62
TNMG-MP	Turning Insert_Negative (Lever Lock/Wedge Clamp/Multi Lock System)	B59
TNMG-RK	Turning Insert_Negative (Lever Lock/Wedge Clamp/Multi Lock System)	B62

T

TNMG-RM	Turning Insert_Negative (Lever Lock/Wedge Clamp/Multi Lock System)	B63
TNMG-VB	Turning Insert_Negative (Lever Lock/Wedge Clamp/Multi Lock System)	B58
TNMG-VC	Turning Insert_Negative (Lever Lock/Wedge Clamp/Multi Lock System)	B59
TNMG-VF	Turning Insert_Negative (Lever Lock/Wedge Clamp/Multi Lock System)	B58
TNMG-VL	Turning Insert_Negative (Lever Lock/Wedge Clamp/Multi Lock System)	B58
TNMG-VM	Turning Insert_Negative (Lever Lock/Wedge Clamp/Multi Lock System)	B59
TNMG-VP2	Turning Insert_Negative (Lever Lock/Wedge Clamp/Multi Lock System)	B63
TNMG-VP3	Turning Insert_Negative (Lever Lock/Wedge Clamp/Multi Lock System)	B63
TNMG-VP4	Turning Insert_Negative (Lever Lock/Wedge Clamp/Multi Lock System)	B63
TNMG-VQ	Turning Insert_Negative (Lever Lock/Wedge Clamp/Multi Lock System)	B60
TNMG-VR	Turning Insert_Negative (Lever Lock/Wedge Clamp/Multi Lock System)	B62
TNMG-VW	Turning Insert_Negative (Lever Lock/Wedge Clamp/Multi Lock System)	B64
TNMM-GH	Turning Insert_Negative (Lever Lock/Wedge Clamp/Multi Lock System)	B65
TNMM-GR	Turning Insert_Negative (Lever Lock/Wedge Clamp/Multi Lock System)	B65
TNMX	Turning Insert_Negative (Lever Lock/Wedge Clamp/Multi Lock System)	B65
TNMX-NM	Milling Insert (Power Buster)	E28
TNMX-SH	Turning Insert_Negative (Lever Lock/Wedge Clamp/Multi Lock System)	B64
TNMX-SR	Turning Insert_Negative	B64
TOEH	Turning Insert_Positive	B90
TP2PCM-LN08	TP2P	E311
TP2PCM-LN14	TP2P	E312
TP2PCM-LN17	TP2P	E313
TP2PS-LN08	TP2P	E314
TP2PS-LN14	TP2P	E315
TP2PS-LN17	TP2P	E316
TPCN	Milling Insert (Mill-max, Side cutter)	E28
TPD	Drill Insert (TPDC Plus Drill)	F47~49
TPD	Drill Insert (TPDB Plus Drill)	F57
TPD	Drill Insert (TPDB-F)	F66
TPD	Drill Insert (TPDB-H)	F71
TPDB-F(1.5D)	Drill (TPDB-F)	F67
TPDB-H(3D)	Drill (TPDB-H)	F72
TPDB-H(4D)	Drill (TPDB-H)	F73
TPDB-H(8D)	Drill (TPDB-H)	F74
TPDB-P(10D)	Drill (TPDB Plus)	F61
TPDB-P(12D)	Drill (TPDB Plus)	F62
TPDB-P(3D)	Drill (TPDB Plus)	F58
TPDB-P(5D)	Drill (TPDB Plus)	F59
TPDB-P(8D)	Drill (TPDB Plus)	F60
TPDC(1.5D)	Drill (TPDC Plus)	F51
TPDC(10D)	Drill (TPDC Plus)	F53
TPDC(12D)	Drill (TPDC Plus)	F53
TPDC(3D)	Drill (TPDC Plus)	F51
TPDC(5D)	Drill (TPDC Plus)	F52
TPDC(8D)	Drill (TPDC Plus)	F52



K Index by designation

T

TPDX(3D)	Drill (TPDC Plus)	F50
TPDX(5D)	Drill (TPDC Plus)	F50
TPDX(8D)	Drill (TPDC Plus)	F50
TPGB	cBN Insert_Positive (Regrinding)	B112
TPGH	Turning Insert_Positive	B93
TPGN	PCD Insert_Positive	B113
TPGN	Turning Insert_Positive	B92
TPGR-F	Turning Insert_Positive (Clamp on System)	B91
TPGR-M	Turning Insert_Positive (Clamp on System)	B92
TPGT	Turning Insert_Positive (Screw on System)	B93
TPGW	PCD Insert_Positive	B113
TPGX	Turning Insert_Positive (Screw on System)	B93
TPKN-MU	Milling Insert (Mill-max)	E29
TPKN-SU	Milling Insert (Mill-max)	E29
TPKR-MX	Milling Insert (Mill-max)	E29
TPMCM-TN16	Triple Mill	E258
TPMCM-TN20	Triple Mill	E259
TPMR-F	Turning Insert_Positive (Clamp on System)	B91
TPMR-M	Turning Insert_Positive (Clamp on System)	B91
TPMS-TN11	Triple Mill	E260
TPMS-TN16	Triple Mill	E261
TPMT-FP	Turning Insert_Positive (Screw on System)	B90
TPMT-MP	Turning Insert_Positive (Screw on System)	B91
TPMT-VF	Turning Insert_Positive (Screw on System)	B91
TPMT-VL	Turning Insert_Positive (Screw on System)	B91
TPUN	Turning Insert_Positive	B92
T-TPGB	cBN Insert_Negative (Regrinding)	B112
T-VNMA	cBN Insert_Negative (Regrinding)	B112
TWX-KC	Milling Insert (Multi functional Chamfer Tool)	E29

U

UNJ (Unified Constant Thread)	Thread Insert	D26
--------------------------------------	---------------	------------

V

VB Chip Breaker	Turning Chip Breaker	B29
VBGT	Aluminum Insert_Positive (Screw on System)	B95
VBGT-AK	Aluminum Insert_Positive (Screw on System)	B108
VBGT-AR	Turning Insert_Positive (Screw on System)	B108
VBGT-FS	Auto tools Insert (ISO type)	B133
VBGT-FS	Turning Insert_Positive (Screw on System)	B95
VBGT-KF	Auto tools Insert (ISO type)	B133
VBGT-KF	Turning Insert_Positive (Screw on System)	B96
VBGT-KM	Auto tools Insert (ISO type)	B133

V

VBGT-KM	Turning Insert_Positive (Screw on System)	B96
VBGT-VP1	Turning Insert_Positive (Screw on System)	B95
VBGW	PCD Insert_Positive	B113
VBMT	PCD Insert_Positive	B113
VBMT	Turning Insert_Positive (Screw on System)	B95
VBMT-FP	Turning Insert_Positive (Screw on System)	B94
VBMT-HMP	Turning Insert_Positive (Screw on System)	B94
VBMT-MP	Turning Insert_Positive (Screw on System)	B94
VBMT-VB	Turning Insert_Positive (Screw on System)	B94
VBMT-VF	Turning Insert_Positive (Screw on System)	B94
VBMT-VL	Turning Insert_Positive (Screw on System)	B94
VBMT-VP1	Turning Insert_Positive (Screw on System)	B95
VBMW	cBN Insert_Positive (Regrinding)	B112
VC Chip Breaker	Turning Chip Breaker	B30
VCET-KF	Auto Tools Insert (ISO type)	B134
VCET-KF	Turning Insert_Positive (Screw on System)	B99
VCET-KM	Auto Tools Insert (ISO type)	B134
VCET-KM	Turning Insert_Positive (Screw on System)	B99
VCGT-AK	Aluminum Insert_Positive (Screw on System)	B109
VCGT-AR	Aluminum Insert_Positive (Screw on System)	B109
VCGT-FS	Auto Tools Insert (ISO type)	B134
VCGT-FS	Turning Insert_Positive (Screw on System)	B98
VCGT-KF	Auto Tools Insert (ISO type)	B133
VCGT-KF	Turning Insert_Positive (Screw on System)	B99
VCGT-KM	Auto Tools Insert (ISO type)	B134
VCGT-KM	Turning Insert_Positive (Screw on System)	B99
VCGT-MS	Auto Tools Insert (ISO type)	B134
VCGT-MS	Turning Insert_Positive (Screw on System)	B98
VCGT-VP1	Auto Tools Insert (ISO type)	B134
VCGT-VP1	Turning Insert_Positive (Screw on System)	B98
VCGX-VP1	Auto Tools Insert (ISO type)	B134
VCGX-VP1	Turning Insert_Positive (Screw on System)	B99
VCKT-MA	Milling Insert (Pro-A Mill)	E29
VCMT	PCD Insert_Positive	B113
VCMT-FP	Turning Insert_Positive (Screw on System)	B97
VCMT-HMP	Turning Insert_Positive (Screw on System)	B97
VCMT-MP	Turning Insert_Positive (Screw on System)	B97
VCMT-VF	Turning Insert_Positive (Screw on System)	B97
VCMT-VL	Turning Insert_Positive (Screw on System)	B97
VCMT-VP1	Turning Insert_Positive (Screw on System)	B97
VDKT-MA	Milling Insert (Pro-A Mill)	E29
VETR	Thread Insert (Vertical Type)	D33
VH Chip Breaker	Turning Chip Breaker	B31
VL Chip Breaker	Turning Chip Breaker	B29
VNGG-HA	Turning Insert_Negative (Multi Lock System)	B67



V

VNMG-VP3	Turning Insert_Negative (Multi Lock System)	B67
VNMA	cBN Insert_Negative (Regrinding)	B112
VNMG-CP	Turning Insert_Negative (Multi Lock System)	B66
VNMG-HM	Turning Insert_Negative	B66
VNMG-LP	Turning Insert_Negative (Multi Lock System)	B66
VNMG-MK	Turning Insert_Negative (Multi Lock System)	B67
VNMG-MM	Turning Insert_Negative (Multi Lock System)	B67
VNMG-MP	Turning Insert_Negative (Multi Lock System)	B66
VNMG-RM	Turning Insert_Negative (Multi Lock System)	B67
VNMG-VB	Turning Insert_Negative (Multi Lock System)	B66
VNMG-VC	Turning Insert_Negative (Multi Lock System)	B66
VNMG-VF	Turning Insert_Negative (Multi Lock System)	B66
VNMG-VL	Turning Insert_Negative (Multi Lock System)	B66
VNMG-VM	Turning Insert_Negative (Multi Lock System)	B67
VNMG-VP3	Turning Insert_Negative (Multi Lock System)	B67
VNMG-VQ	Turning Insert_Negative (Multi Lock System)	B67
VP1 Chip Breaker	Turning Chip Breaker	B26
VP2 Chip Breaker	Turning Chip Breaker	B26
VP3 Chip Breaker	Turning Chip Breaker	B27
VP4 Chip Breaker	Turning Chip Breaker	B27
VPET-KF	Turning Insert_Positive (Screw on System)	B100
VPET-KF	Auto Tools Insert (ISO type)	B135
VPET-KM	Turning Insert_Positive (Screw on System)	B100
VPET-KM	Auto Tools Insert (ISO type)	B135
VPGT-KF	Auto Tools Insert (ISO type)	B135
VPGT-KM	Auto Tools Insert (ISO type)	B135
VPGT-VP1	Turning Insert_Positive (Screw on System)	B100
VPGT-VP1	Auto Tools Insert (ISO type)	B135
VQ Chip Breaker	Turning Chip Breaker	B30
VT Chip Breaker	Turning Chip Breaker	B31
VTH	Vertical Type Holder	D33
VW Chip Breaker	Turning Chip Breaker	B32

W

WBGT	Turning Insert_Positive (Compact Mini)	B101
WCMT-C20N	Drill Insert (WPDC)	F04
WCMT-C21N	Drill Insert (WPDC)	F04
WDKT-MH	Milling Insert (HRM)	E29
WFSB(M)	Wind Mill (Boss type)	E416
WFSP(M)	Wind Mill (Plane type)	E417
WNGG-VP3	Turning Insert_Negative (Lever Lock/Wedge Clamp/Multi Lock System)	B71
WNGX-MA	Milling Insert (Rich Mill)	E30
WNGX-ML	Milling Insert (Rich Mill)	E30
WNGX-MM	Milling Insert (Rich Mill)	E30

W

WNMA	Turning Insert_Negative (Lever Lock/Wedge Clamp/Multi Lock System)	B70
WNMG-B25	Turning Insert_Negative (Lever Lock/Wedge Clamp/Multi Lock System)	B69
WNMG-CP	Turning Insert_Negative (Lever Lock/Wedge Clamp/Multi Lock System)	B68
WNMG-GR	Turning Insert_Negative (Lever Lock/Wedge Clamp/Multi Lock System)	B69
WNMG-HA	Turning Insert_Negative (Lever Lock/Wedge Clamp/Multi Lock System)	B72
WNMG-HM	Turning Insert_Negative	B69
WNMG-LP	Turning Insert_Negative (Lever Lock/Wedge Clamp/Multi Lock System)	B68
WNMG-LW	Turning Insert_Negative (Lever Lock/Wedge Clamp/Multi Lock System)	B72
WNMG-MK	Turning Insert_Negative (Lever Lock/Wedge Clamp/Multi Lock System)	B70
WNMG-MM	Turning Insert (SAVE TURN)	B115
WNMG-MM	Turning Insert_Negative (Lever Lock/Wedge Clamp/Multi Lock System)	B71
WNMG-MP	Turning Insert (SAVE TURN)	B115
WNMG-MP	Turning Insert_Negative (Lever Lock/Wedge Clamp/Multi Lock System)	B69
WNMG-RK	Turning Insert_Negative (Lever Lock/Wedge Clamp/Multi Lock System)	B70
WNMG-RM	Turning Insert_Negative (Lever Lock/Wedge Clamp/Multi Lock System)	B71
WNMG-VB	Turning Insert_Negative (Lever Lock/Wedge Clamp/Multi Lock System)	B68
WNMG-VC	Turning Insert_Negative (Lever Lock/Wedge Clamp/Multi Lock System)	B68
WNMG-VF	Turning Insert_Negative (Lever Lock/Wedge Clamp/Multi Lock System)	B68
WNMG-VL	Turning Insert_Negative (Lever Lock/Wedge Clamp/Multi Lock System)	B68
WNMG-VM	Turning Insert_Negative (Lever Lock/Wedge Clamp/Multi Lock System)	B69
WNMG-VP2	Turning Insert_Negative (Lever Lock/Wedge Clamp/Multi Lock System)	B71
WNMG-VP3	Turning Insert_Negative (Lever Lock/Wedge Clamp/Multi Lock System)	B71
WNMG-VP4	Turning Insert_Negative (Lever Lock/Wedge Clamp/Multi Lock System)	B71
WNMG-VQ	Turning Insert (SAVE TURN)	B115
WNMG-VQ	Turning Insert_Negative (Lever Lock/Wedge Clamp/Multi Lock System)	B70
WNMG-VR	Turning Insert_Negative (Lever Lock/Wedge Clamp/Multi Lock System)	B70
WNMG-VW	Turning Insert_Negative (Lever Lock/Wedge Clamp/Multi Lock System)	B72
WNMM-B25	Turning Insert_Negative (Lever Lock/Wedge Clamp/Multi Lock System)	B72
WNMX-MF	Milling Insert (HRMDouble)	E30
WNMX-ML	Milling Insert (HRMDouble)	E30
WNMX-MM	Milling Insert (HRMDouble)	E30
WNMX-SH	Turning Insert_Negative (Lever Lock/Wedge Clamp/Multi Lock System)	B72
WNMX-SR	Turning Insert_Negative	B72
WPDC-5D	Drill (WPDC Standard type)	F79
WPDC-5D	Drill (WPDC Dual insert cartridge type)	F81
WPDC-5D	Drill (WPDC Single insert cartridge type)	F80
WPDC-6.5D	Drill (WPDC Standard type)	F79
WPDC-6.5D	Drill (WPDC Dual insert cartridge type)	F81
WPDC-6.5D	Drill (WPDC Single insert cartridge type)	F80
WPDC-8D	Drill (WPDC Standard type)	F79
WPDC-8D	Drill (WPDC Dual insert cartridge type)	F81
WPDC-8D	Drill (WPDC Single insert cartridge type)	F80
WS	Side Cutter	E413
WTENN	Holder (Wedge Clamp System)	B179
WTJNR/L	Holder (Wedge Clamp System)	B179



K Index by designation

W

WTXNR/L	Holder (Wedge Clamp System)	B179
WWLNR/L	Holder (Wedge Clamp System)	B180

X

XCET-KC	Milling Insert (Chamfer Tool)	E31
XDET-MA	Milling Insert (Pro-V Mill)	E31
XEKT-MA	Milling Insert (Pro-X Mill)	E31
XEKT-ML	Milling Insert (Pro-X Mill)	E31
XNCT-MA	Milling Insert (Rich Mill)	E31
XNKT-ML	Milling Insert (Rich Mill)	E32
XNKT-MM	Milling Insert (Rich Mill)	E32
XNMX-ML	Milling Insert (Rich Mill)	E32
XOET-ND	Drill Insert (KING DRILL)	F04
XOMT-LD	Drill Insert (KING DRILL)	F03
XOMT-PD	Drill Insert (KING DRILL)	F03
XOMT-RD	Drill Insert (KING DRILL)	F04
XPMT-MM	Milling Insert (HAVE)	E32

Z

ZDMT-R-MM	Milling Insert (BRE)	E33
ZPET-MM	Milling Insert (GBE)	E33
ZPMT-MM	Milling Insert (BT Tooling System, Tank Mill)	E33
ZPMT-R-MM	Milling Insert (BRE)	E33
ZPMT-R-MR	Milling Insert (BRE)	E33



KORLOY

Global Network

Head Office

Holystar B/D, 326, Seocho-daero, Seocho-gu,
Seoul, 06633, Republic of Korea

Tel: +82-2-522-3181 Fax: +82-2-522-3184, +82-2-3474-4744



Cheongju Factory

55, Sandan-ro, Heungdeok-gu, Cheongju-si,
Chungcheongbuk-do, 28589, Korea

Tel: +82-43-262-0141 Fax: +82-43-263-8731



Jincheon Factory

54, Gwanghyewonsandan 2-gil, Gwanghyewon-myeon,
Jincheon-gun, Chungcheongbuk-do, 27807, Korea

Tel: +82-43-535-0141 Fax: +82-43-535-0144



KORLOY America

620 Maple Avenue, Torrance, CA 90503, USA

Tel: +1-310-782-3800 Toll free: +1-888-711-0001 Fax: +1-310-782-3885
E-mail: sales.kai@korloy.com



KORLOY Europe

Gablonzer Str. 25-27, 61440 Oberursel, Germany

Tel: +49-6171-277-83-0 Fax: +49-6171-277-83-59
E-mail: sales.keg@korloy.com



KORLOY India

Plot No. 415, Sector 8, IMT Manesar, Gurgaon 122051, Haryana, India

Tel: +91-124-4391790 Fax: +91-124-4050032
E-mail: sales.kip@korloy.com



KORLOY Brasil

Av. Aruana 280, conj.12, WLC, Alphaville, Barueri,
CEP06460-010, SP, Brasil

Tel: +55-11-4193-3810 E-mail: sales.kbl@korloy.com



KORLOY Turkey

Serifali Mahallesi, Burhan Sokak NO: 34
Dudullu OSB/Umraniye/Istanbul, 34775, Turkey

Tel: +90-216-415-8874 E-mail: sales.ktl@korloy.com



KORLOY Chile

Av. Providencia 1650, Office 1009, 7500027 Providencia-Santiago, Chile

Tel: +56-229-295-490 E-mail: sales.kcs@korloy.com



KORLOY Russia

Krasivy Dom office No. 305, Bld. 5, Novovladykinskiy proezd 8, 127106,
Moscow, Russia

Tel: +7-495-280-1458 Fax: +7-495-280-1459
E-mail: sales.krc@korloy.com



KORLOY Factory India

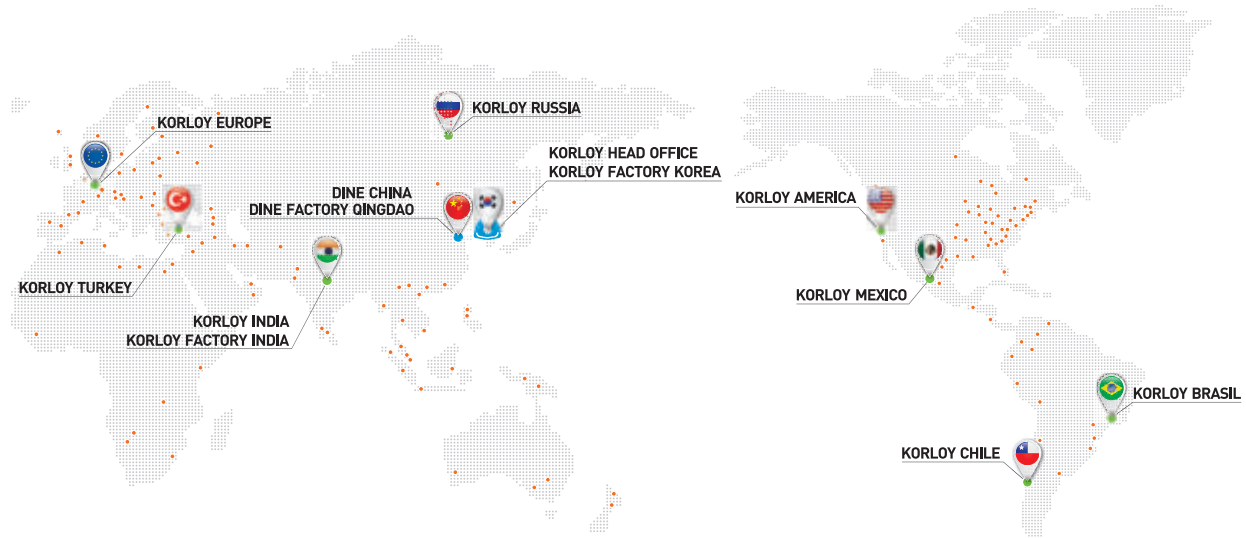
Plot No. 415, Sector 8, IMT Manesar, Gurgaon 122051, Haryana, India

Tel: +91-124-4391790 Fax: +91-124-4050032
E-mail: pro.kim@korloy.com



KORLOY Global Network

We stand to be the Global Top Manufacturer. Korea's Best. World's Best



KORLOY

Head Office

Holystar B/D, 326, Seocho-daero, Seocho-gu,
Seoul, 06633, Republic of Korea

Tel: +82-2-522-3181 Fax: +82-2-522-3184, +82-2-3474-4744

R&D Institute Cheongju

55, Sandan-ro, Heungdeok-gu, Cheongju-si,
Chungcheongbuk-do, 28589, Korea

Tel: +82-43-262-0141 Fax: +82-43-262-0711

Cheongju Factory

55, Sandan-ro, Heungdeok-gu, Cheongju-si,
Chungcheongbuk-do, 28589, Korea

Tel: +82-43-262-0141 Fax: +82-43-263-8731

Jincheon Factory

54, Gwanghyewonsandan 2-gil, Gwanghyewon-myeon,
Jincheon-gun, Chungcheongbuk-do, 27807, Korea

Tel: +82-43-535-0141 Fax: +82-43-535-0144

KORLOY AMERICA

620 Maple Avenue, Torrance, CA 90503, USA

Tel: +1-310-782-3800 Toll Free: +1-888-711-0001 Fax: +1-310-782-3885

E-mail: sales.kai@korloy.com

KORLOY INDIA

Plot No. 415, Sector 8, IMT Manesar, Gurgaon 122051, Haryana, India

Tel: +91-124-4391790 Fax: +91-124-4050032

E-mail: sales.kip@korloy.com

KORLOY TURKEY

Serifali Mahallesi, Burhan Sokak NO: 34

Dudullu OSB/Umraniye/Istanbul, 34775, Turkey

Tel: +90-216-415-8874 E-mail: sales.ktl@korloy.com

KORLOY RUSSIA

Krasivy Dom office No. 305, Bld. 5, Novovladynkiy proezd 8, 127106,
Moscow, Russia

Tel: +7-495-280-1458 Fax: +7-495-280-1459 E-mail: sales.krc@korloy.com

KORLOY FACTORY INDIA

Plot No. 415, Sector 8, IMT Manesar, Gurgaon 122051, Haryana, India

Tel: +91-124-4391790 Fax: +91-124-4050032

E-mail: pro.kim@korloy.com

KORLOY EUROPE

Gablonzer Str. 25-27, 61440 Oberursel, Germany

Tel: +49-6171-277-83-0 Fax: +49-6171-277-83-59

E-mail: sales.keg@korloy.com

KORLOY BRASIL

Av. Aruana 280, conj.12, WLC, Alphaville, Barueri,
CEP06460-010, SP, Brasil

Tel: +55-11-4193-3810 E-mail: sales.kbl@korloy.com

KORLOY CHILE

Av. Providencia 1650, Office 1009, 7500027

Providencia-Santiago, Chile

Tel: +56-229-295-490 E-mail: sales.kcs@korloy.com

KORLOY MEXICO

Calle R. M. Clemencia Borja Taboada 522, Jurica Acueducto,
76230 Juriquilla, Qro., Mexico

Tel: +52-442-673-7388 E-mail: sales.kml@korloy.com

www.korloy.com



CA-EM-01 / 20220630